



SiGe High-Linearity, 1700MHz to 2200MHz Downconversion Mixer with LO Buffer/Switch

MAX9996

General Description

The MAX9996 high-linearity downconversion mixer provides 8.3dB gain, +26.5dBm IIP3, and 9.7dB NF for 1700MHz to 2200MHz UMTS/WCDMA, DCS, and PCS base-station receiver applications. With a 1900MHz to 2400MHz LO frequency range, this particular mixer is ideal for high-side LO injection receiver architectures. Low-side LO injection is supported by the MAX9994, which is pin-for-pin and functionally compatible with the MAX9996.

In addition to offering excellent linearity and noise performance, the MAX9996 also yields a high level of component integration. This device includes a double-balanced passive mixer core, an IF amplifier, a dual-input LO selectable switch, and an LO buffer. On-chip baluns are also integrated to allow for single-ended RF and LO inputs. The MAX9996 requires a nominal LO drive of 0dBm, and supply current is guaranteed to be below 240mA.

The MAX9994/MAX9996 are pin compatible with the MAX9984/MAX9986 815MHz to 995MHz mixers, making this entire family of downconverters ideal for applications where a common PC board layout is used for both frequency bands. The MAX9996 is also functionally compatible with the MAX9993.

The MAX9996 is available in a compact, 20-pin, thin QFN package (5mm x 5mm) with an exposed paddle. Electrical performance is guaranteed over the extended -40°C to +85°C temperature range.

Applications

UMTS/WCDMA Base Stations
DCS1800/PCS1900 EDGE Base Stations
cdmaOne™ and cdma2000® Base Stations
PHS/PAS Base Stations
Predistortion Receivers
Fixed Broadband Wireless Access
Wireless Local Loop
Private Mobile Radios
Military Systems
Microwave Links
Digital and Spread-Spectrum Communication Systems

cdma2000 is a registered trademark of Telecommunications Industry Association.

cdmaOne is a trademark of CDMA Development Group.

Features

- ◆ 1700MHz to 2200MHz RF Frequency Range
- ◆ 1900MHz to 2400MHz LO Frequency Range (MAX9996)
- ◆ 1400MHz to 2000MHz LO Frequency Range (MAX9994)
- ◆ 40MHz to 350MHz IF Frequency Range
- ◆ 8.3dB Conversion Gain
- ◆ +26.5dBm Input IP3
- ◆ +12.6dBm Input 1dB Compression Point
- ◆ 9.7dB Noise Figure
- ◆ 72dBc 2LO-2RF Spurious Rejection at PRF = -10dBm
- ◆ Integrated LO Buffer
- ◆ Integrated RF and LO Baluns for Single-Ended Inputs
- ◆ Low -3dBm to +3dBm LO Drive
- ◆ Built-In SPDT LO Switch with 43dB LO1 to LO2 Isolation and 50ns Switching Time
- ◆ Pin Compatible with MAX9984/MAX9986 815MHz to 995MHz Mixers
- ◆ Functionally Compatible with MAX9993
- ◆ External Current-Setting Resistors Provide Option for Operating Mixer in Reduced Power/Reduced Performance Mode
- ◆ Lead-Free Package Available

Ordering Information

PART	TEMP RANGE	PIN-PACKAGE	PKG CODE
MAX9996ETP	-40°C to +85°C	20 Thin QFN-EP* 5mm x 5mm	T2055-3
MAX9996ETP-T	-40°C to +85°C	20 Thin QFN-EP* 5mm x 5mm	T2055-3
MAX9996ETP+D	-40°C to +85°C	20 Thin QFN-EP* 5mm x 5mm	T2055-3
MAX9996ETP+TD	-40°C to +85°C	20 Thin QFN-EP* 5mm x 5mm	T2055-3

*EP = Exposed paddle.

+ = Lead free. D = Dry pack. T = Tape-and-reel.

Pin Configuration/Functional Diagram and Typical Application Circuit appear at end of data sheet.



SiGe High-Linearity, 1700MHz to 2200MHz Downconversion Mixer with LO Buffer/Switch

ABSOLUTE MAXIMUM RATINGS

V _{CC} to GND	-0.3V to +5.5V	θ _{JA}	+38°C/W
IF+, IF-, LOBIAS, LOSEL, IFBIAS to GND ...	-0.3V to (V _{CC} + 0.3V)	θ _{JC}	+13°C/W
TAP	-0.3V to +1.4V	Operating Temperature Range (Note A)	T _C = -40°C to +85°C
LO1, LO2, LEXT to GND.....	-0.3V to +0.3V	Junction Temperature	+150°C
RF, LO1, LO2 Input Power	+12dBm	Storage Temperature Range	-65°C to +150°C
RF (RF is DC shorted to GND through a balun)	50mA	Lead Temperature (soldering, 10s)	+300°C
Continuous Power Dissipation (T _A = +70°C)			
20-Pin Thin QFN-EP (derate 26.3mW/°C above +70°C).....	2.1W		

Note A: T_C is the temperature on the exposed paddle of the package.

Stresses beyond those listed under "Absolute Maximum Ratings" may cause permanent damage to the device. These are stress ratings only, and functional operation of the device at these or any other conditions beyond those indicated in the operational sections of the specifications is not implied. Exposure to absolute maximum rating conditions for extended periods may affect device reliability.

DC ELECTRICAL CHARACTERISTICS

(MAX9996 Typical Application Circuit, V_{CC} = +4.75V to +5.25V, no RF signal applied, IF+ and IF- outputs pulled up to V_{CC} through inductive chokes, R₁ = 806Ω, R₂ = 549Ω, T_C = -40°C to +85°C, unless otherwise noted. Typical values are at V_{CC} = +5V, T_C = +25°C, unless otherwise noted.)

PARAMETER	SYMBOL	CONDITIONS	MIN	TYP	MAX	UNITS
Supply Voltage	V _{CC}		4.75	5.00	5.25	V
Supply Current	I _{CC}			206	240	mA
LO_SEL Input-Logic Low	V _{IL}				0.8	V
LO_SEL Input-Logic High	V _{IH}		2			V

AC ELECTRICAL CHARACTERISTICS

(MAX9996 Typical Application Circuit, V_{CC} = +4.75V to +5.25V, RF and LO ports are driven from 50Ω sources, P_{LO} = -3dBm to +3dBm, P_{RF} = -5dBm, f_{RF} = 1700MHz to 2200MHz, f_{LO} = 1900MHz to 2400MHz, f_{IF} = 200MHz, f_{LO} > f_{RF}, T_C = -40°C to +85°C, unless otherwise noted. Typical values are at V_{CC} = +5V, P_{RF} = -5dBm, P_{LO} = 0dBm, f_{RF} = 1900MHz, f_{LO} = 2100MHz, f_{IF} = 200MHz, T_C = +25°C, unless otherwise noted.) (Notes 1, 2)

PARAMETER	SYMBOL	CONDITIONS	MIN	TYP	MAX	UNITS
RF Frequency Range	f _{RF}	(Note 3)	1700		2200	MHz
LO Frequency Range	f _{LO}	(Note 3)	1900		2400	MHz
		MAX9994	1400		2000	
IF Frequency Range	f _{IF}		40		350	MHz
Conversion Gain	G _C	P _{RF} < +2dBm, T _A = +25°C	7.0	8.3	9.0	dB
Gain Variation Over Temperature		T _C = -40°C to +85°C		±0.75		dB
Input Compression Point	P _{1dB}	(Note 4)		12.6		dBm
Input Third-Order Intercept Point	IIP3	Two tones: f _{RF1} = 2000MHz, f _{RF2} = 2001MHz, P _{RF} = -5dBm/tone, f _{LO} = 2200MHz, P _{LO} = 0dBm, T _A = +25°C	23.5	26.5		dBm
Input IP3 Variation Over Temperature		T _C = -40°C to +85°C		±0.5		dB

SiGe High-Linearity, 1700MHz to 2200MHz Downconversion Mixer with LO Buffer/Switch

MAX9996

AC ELECTRICAL CHARACTERISTICS (continued)

(MAX9996 *Typical Application Circuit*, $V_{CC} = +4.75V$ to $+5.25V$, RF and LO ports are driven from 50Ω sources, $P_{LO} = -3dBm$ to $+3dBm$, $P_{RF} = -5dBm$, $f_{RF} = 1700MHz$ to $2200MHz$, $f_{LO} = 1900MHz$ to $2400MHz$, $f_{IF} = 200MHz$, $f_{LO} > f_{RF}$, $T_C = -40^\circ C$ to $+85^\circ C$, unless otherwise noted. Typical values are at $V_{CC} = +5V$, $P_{RF} = -5dBm$, $P_{LO} = 0dBm$, $f_{RF} = 1900MHz$, $f_{LO} = 2100MHz$, $f_{IF} = 200MHz$, $T_C = +25^\circ C$, unless otherwise noted.) (Notes 1, 2)

PARAMETER	SYMBOL	CONDITIONS	MIN	TYP	MAX	UNITS
Noise Figure	NF	Single sideband		9.7		dB
Noise Figure Under-Blocking		$P_{RF} = 5dBm$, $f_{RF} = 2000MHz$, $f_{LO} = 2190MHz$, $f_{BLOCK} = 2100MHz$ (Note 5)		19		dB
LO Drive			-3		+3	dBm
Spurious Response at IF	2 x 2	2LO-2RF	$P_{RF} = -10dBm$	72		dBc
			$P_{RF} = -5dBm$	67		
	3 x 3	3LO-3RF	$P_{RF} = -10dBm$	87		
			$P_{RF} = -5dBm$	77		
LO1 to LO2 Isolation		LO2 selected, $1900MHz < f_{LO} < 2100MHz$		49		dB
		LO1 selected, $1900MHz < f_{LO} < 2100MHz$		43		
Maximum LO Leakage at RF Port		$P_{LO} = +3dBm$		-20		dBm
Maximum LO Leakage at IF Port		$P_{LO} = +3dBm$		-30		dBm
Minimum RF-to-IF Isolation				40		dB
LO Switching Time		50% of LOSEL to IF settled to within 2°		50		ns
RF Port Return Loss				15		dB
LO Port Return Loss		LO1/2 port selected, LO2/1 and IF terminated		16		dB
		LO1/2 port unselected, LO2/1 and IF terminated		26		
IF Port Return Loss		LO driven at $0dBm$, RF terminated into 50Ω , differential 200Ω		20		dB

Note 1: Guaranteed by design and characterization.

Note 2: All limits include external component losses. Output measurements taken at IF output of the *Typical Application Circuit*.

Note 3: Operation outside this range is possible, but with degraded performance of some parameters.

Note 4: Compression point characterized. It is advisable not to operate continuously the mixer RF input above $+12dBm$.

Note 5: Measured with external LO source noise filtered so the noise floor is $-174dBm/Hz$. This specification reflects the effects of all SNR degradations in the mixer, including the LO noise as defined in Maxim Application Note 2021.

SiGe High-Linearity, 1700MHz to 2200MHz Downconversion Mixer with LO Buffer/Switch

Typical Operating Characteristics

(MAX9996 Typical Application Circuit, $V_{CC} = +5.0V$, $P_{LO} = 0dBm$, $P_{RF} = -5dBm$, $f_{LO} > f_{RF}$, $f_{IF} = 200MHz$, unless otherwise noted.)

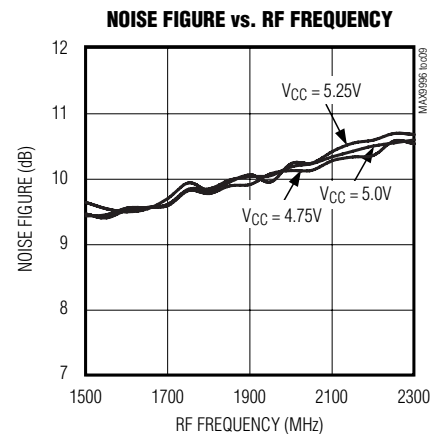
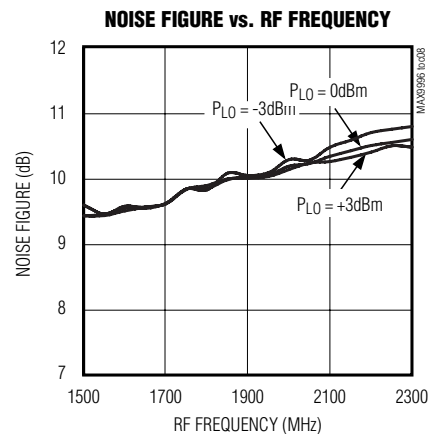
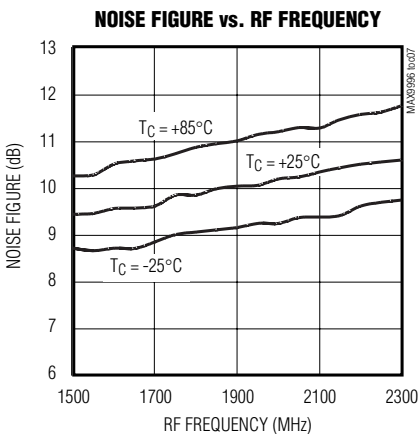
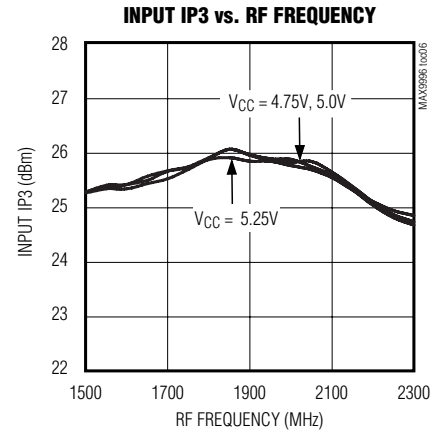
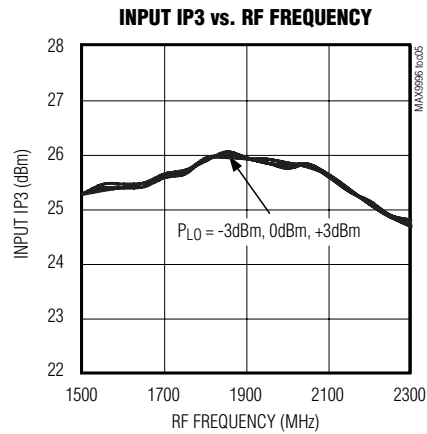
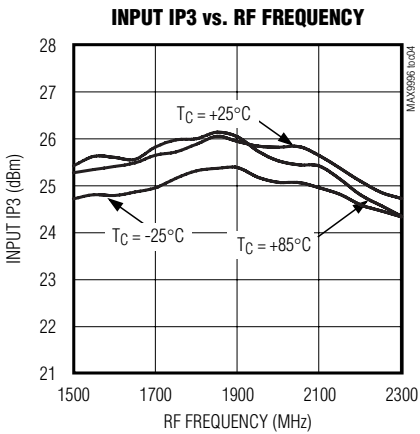
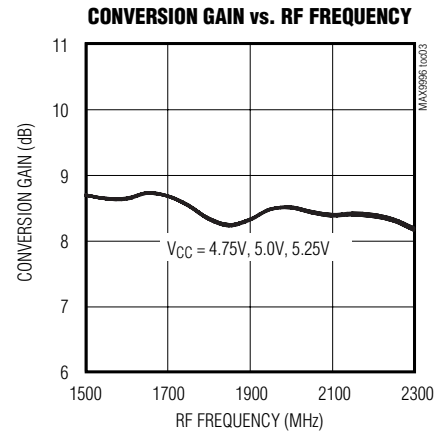
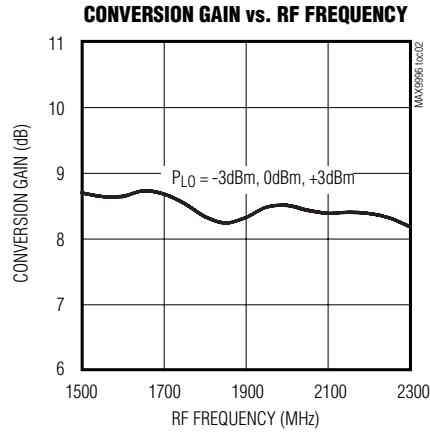
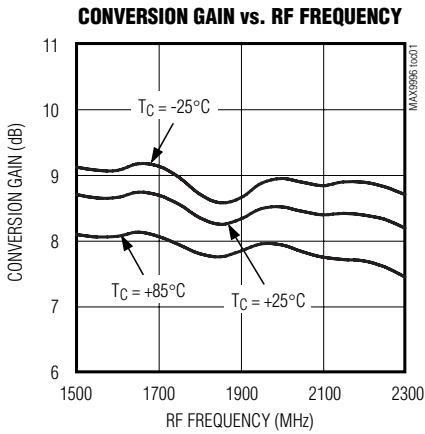

SiGe High-Linearity, 1700MHz to 2200MHz Downconversion Mixer with LO Buffer/Switch

Typical Operating Characteristics (continued)

(MAX9996 Typical Application Circuit, $V_{CC} = +5.0V$, $P_{LO} = 0dBm$, $P_{RF} = -5dBm$, $f_{LO} > f_{RF}$, $f_{IF} = 200MHz$, unless otherwise noted.)

MAX9996

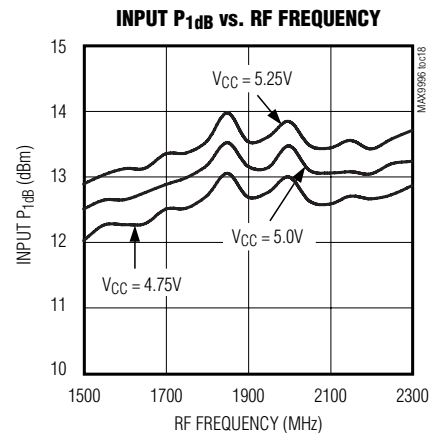
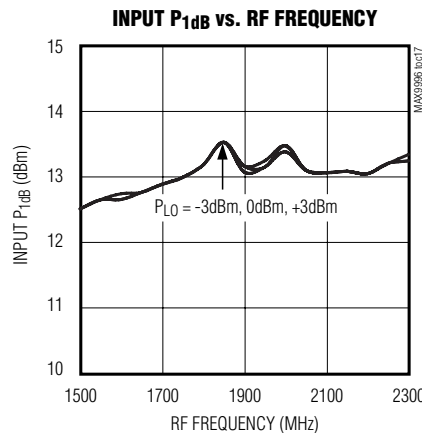
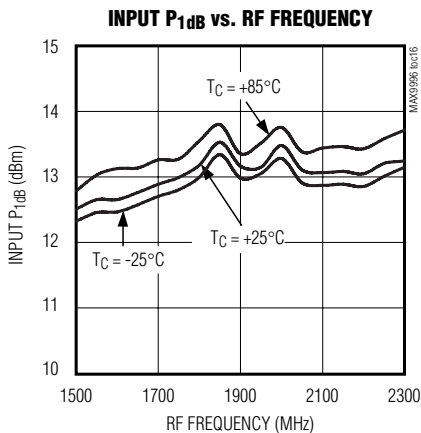
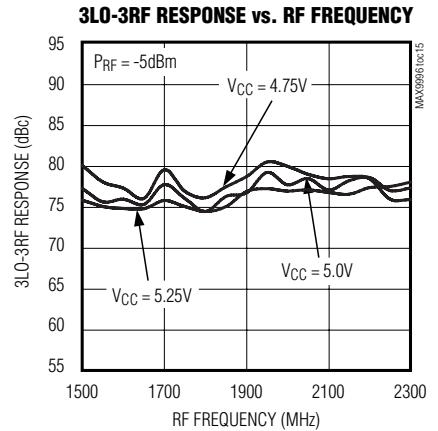
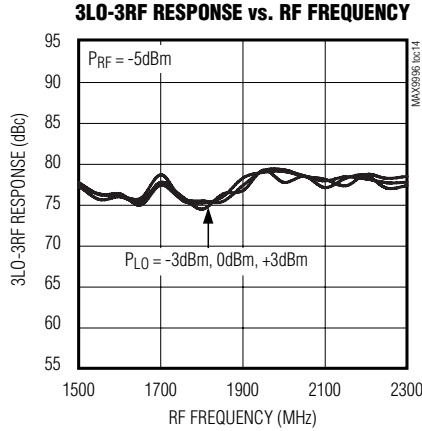
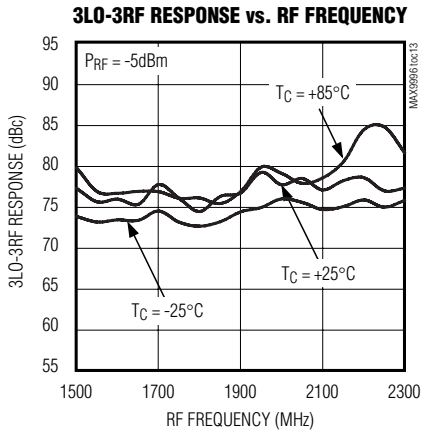
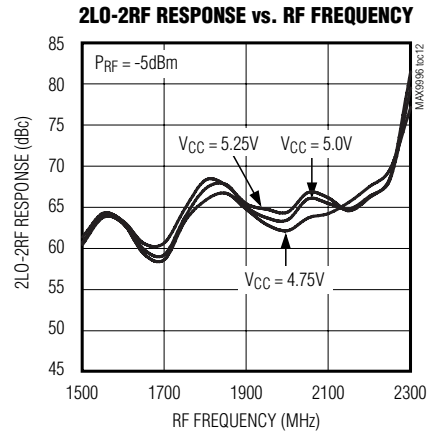
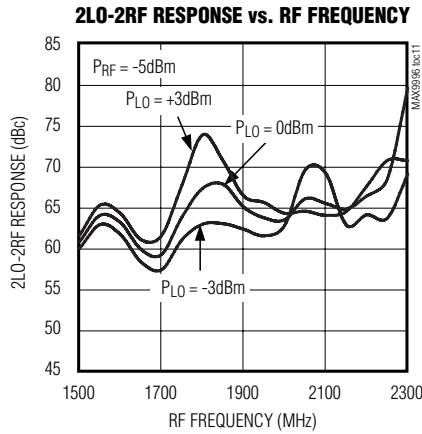
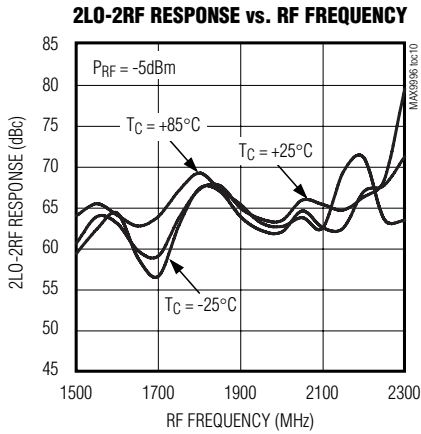

SiGe High-Linearity, 1700MHz to 2200MHz Downconversion Mixer with LO Buffer/Switch

Typical Operating Characteristics (continued)

(MAX9996 Typical Application Circuit, $V_{CC} = +5.0V$, $P_{LO} = 0dBm$, $P_{RF} = -5dBm$, $f_{LO} > f_{RF}$, $f_{IF} = 200MHz$, unless otherwise noted.)

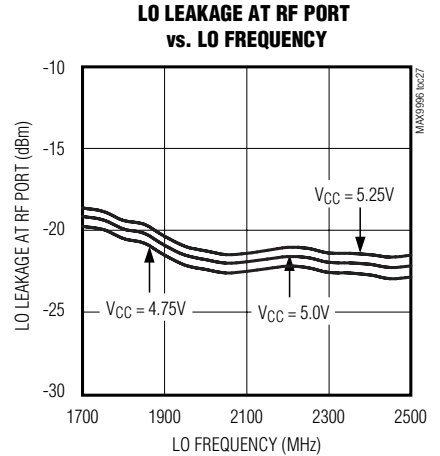
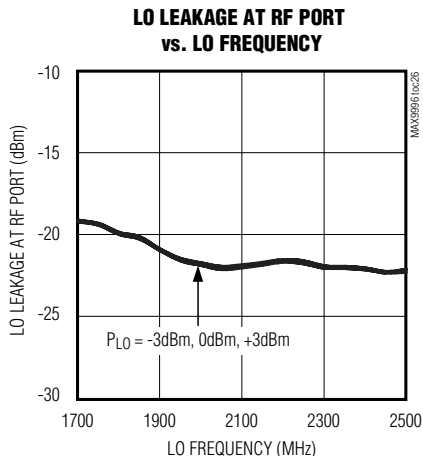
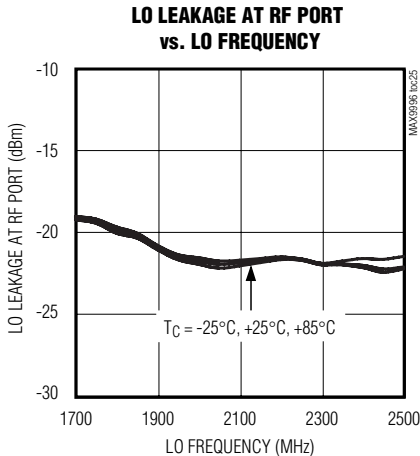
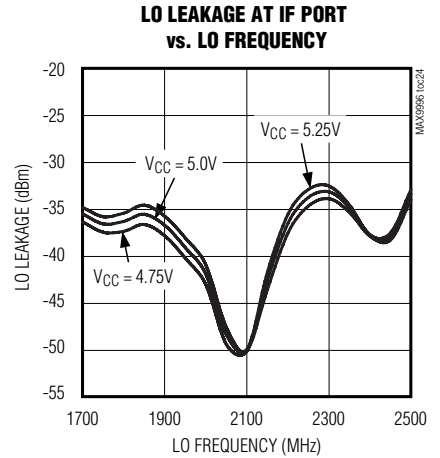
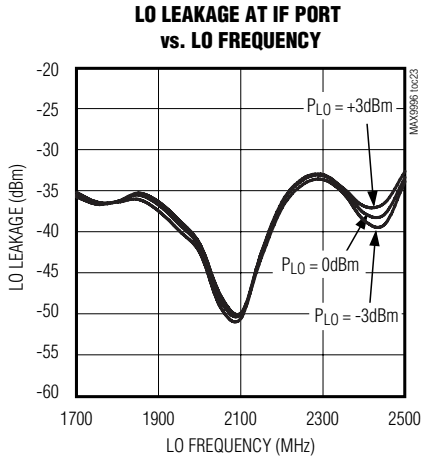
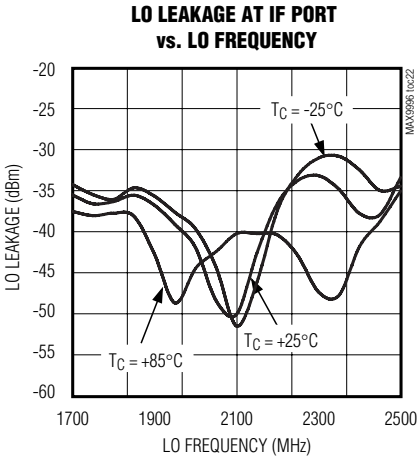
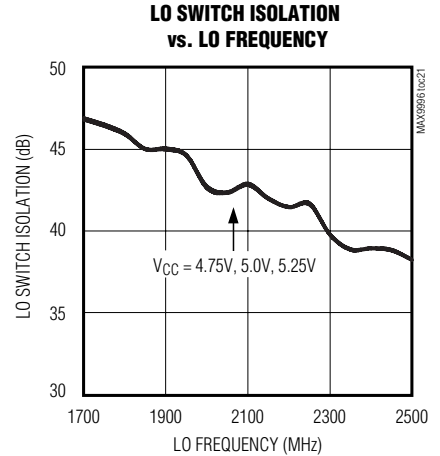
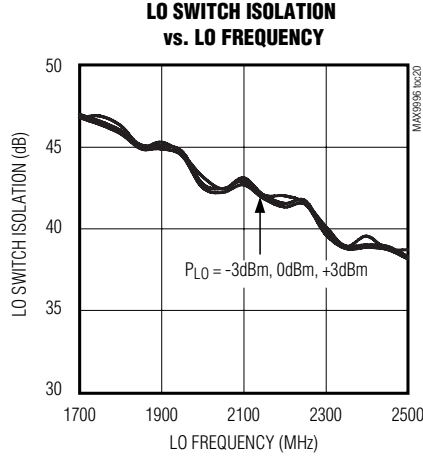
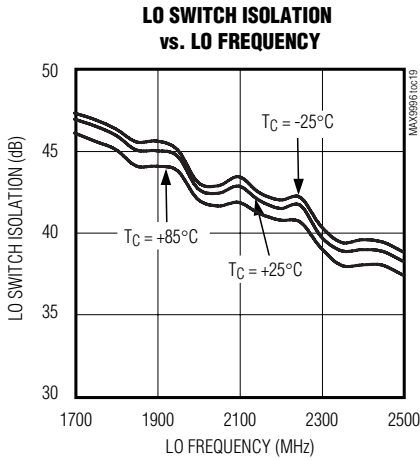

SiGe High-Linearity, 1700MHz to 2200MHz Downconversion Mixer with LO Buffer/Switch

MAX9996

Typical Operating Characteristics (continued)

(MAX9996 Typical Application Circuit, $V_{CC} = +5.0V$, $P_{LO} = 0dBm$, $P_{RF} = -5dBm$, $f_{LO} > f_{RF}$, $f_{IF} = 200MHz$, unless otherwise noted.)

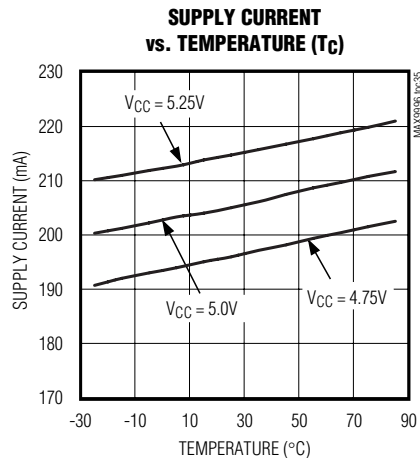
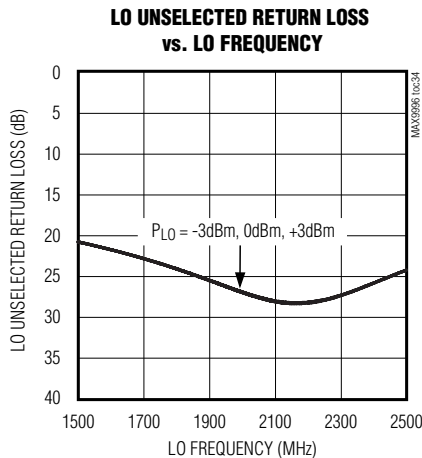
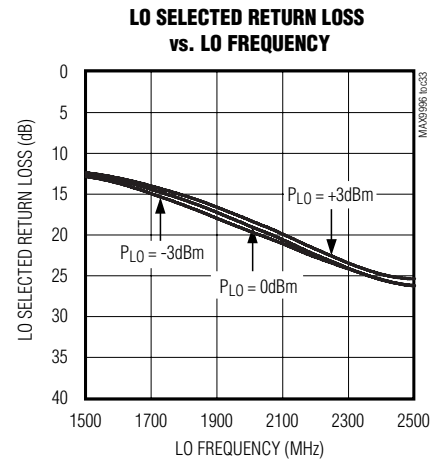
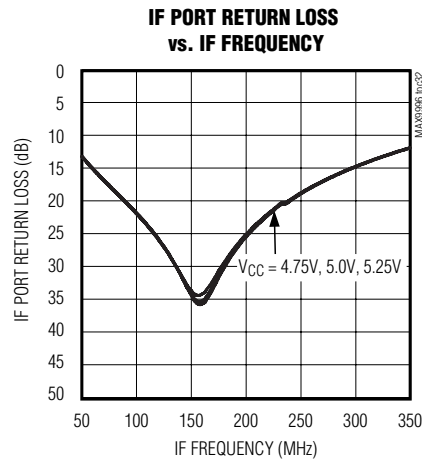
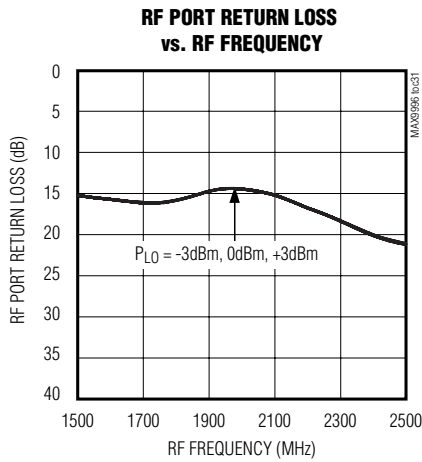
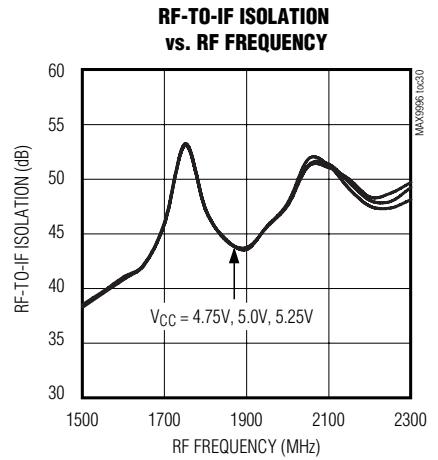
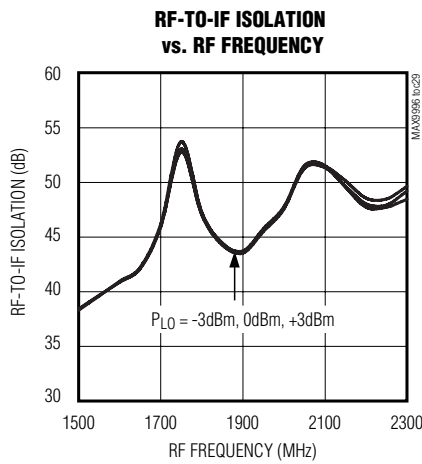
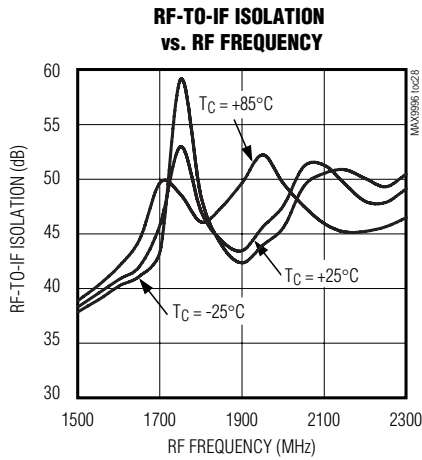

SiGe High-Linearity, 1700MHz to 2200MHz Downconversion Mixer with LO Buffer/Switch

Pin Description

PIN	NAME	FUNCTION
1, 6, 8, 14	VCC	Power-Supply Connection. Bypass each VCC pin to GND with capacitors as shown in the <i>Typical Application Circuit</i> .
2	RF	Single-Ended 50Ω RF Input. This port is internally matched and DC shorted to GND through a balun. Requires an external DC-blocking capacitor.
3	TAP	Center Tap of the Internal RF Balun. Bypass to GND with capacitors close to the IC, as shown in the <i>Typical Application Circuit</i> .
4, 5, 10, 12, 13, 17	GND	Ground
7	LOBIAS	Bias Resistor for Internal LO Buffer. Connect a 549Ω ±1% resistor from LOBIAS to the power supply.
9	LOSEL	Local Oscillator Select. Logic control input for selecting LO1 or LO2.
11	LO1	Local Oscillator Input 1. Drive LOSEL low to select LO1.
15	LO2	Local Oscillator Input 2. Drive LOSEL high to select LO2.
16	LEXT	External Inductor Connection. Connect a low-ESR, 10nH inductor from LEXT to GND. This inductor carries approximately 100mA DC current.
18, 19	IF-, IF+	Differential IF Outputs. Each output requires external bias to VCC through an RF choke (see the <i>Typical Application Circuit</i>).
20	IFBIAS	IF Bias Resistor Connection for IF Amplifier. Connect an 806Ω resistor from IFBIAS to GND.
EP	GND	Exposed Ground Paddle. Solder the exposed paddle to the ground plane using multiple vias.

Detailed Description

The MAX9996 high-linearity downconversion mixer provides 8.3dB of conversion gain and 26.5dBm of IIP3, with a typical 9.7dB noise figure. The integrated baluns and matching circuitry allow for 50Ω single-ended interfaces to the RF and the two LO ports. A single-pole, double-throw (SPDT) switch provides 50ns switching time between the two LO inputs with 43dB of LO-to-LO isolation. Furthermore, the integrated LO buffer provides a high drive level to the mixer core, reducing the LO drive required at the MAX9996's inputs to a -3dBm to +3dBm range. The IF port incorporates a differential output, which is ideal for providing enhanced IIP2 performance.

Specifications are guaranteed over broad frequency ranges to allow for use in UMTS, cdma2000, and 2G/2.5G/3G DCS1800 and PCS1900 base stations. The MAX9996 is specified to operate over a 1700MHz to 2200MHz RF frequency range, a 1900MHz to 2400MHz LO frequency range, and a 40MHz to 350MHz IF frequency range. Operation beyond these ranges is possible; see the *Typical Operating Characteristics* for additional details.

This device can operate in low-side LO injection applications with an extended LO range, but performance degrades as f_{LO} continues to decrease. The MAX9994—a variant of the MAX9996—provides better low-side performance since it is tuned for a lower LO range of 1400MHz to 2000MHz.

RF Input and Balun

The MAX9996 RF input is internally matched to 50Ω, requiring no external matching components. A DC-blocking capacitor is required because the input is internally DC shorted to ground through the on-chip balun. Input return loss is typically 15dB over the entire 1700MHz to 2200MHz RF frequency range.

LO Inputs, Buffer, and Balun

The MAX9996 can be used for either high-side or low-side injection applications with a 1900MHz to 2400MHz LO frequency range. For a device with a 1400MHz to 2000MHz LO frequency range, refer to the MAX9994 data sheet. As an added feature, the MAX9996 includes an internal LO SPDT switch that can be used for frequency-hopping applications. The switch selects one of the two single-ended LO ports, allowing the external oscillator to settle on a particular frequency before it is

SiGe High-Linearity, 1700MHz to 2200MHz Downconversion Mixer with LO Buffer/Switch

switched in. LO switching time is typically less than 50ns, which is more than adequate for virtually all GSM applications. If frequency hopping is not employed, set the switch to either of the LO inputs. The switch is controlled by a digital input (LOSEL): logic-high selects LO2, logic-low selects LO1. To avoid damage to the part, voltage must be applied to VCC before digital logic is applied to LOSEL. LO1 and LO2 inputs are internally matched to 50Ω, requiring only a 22pF DC-blocking capacitor.

A two-stage internal LO buffer allows a wide input power range for the LO drive. All guaranteed specifications are for an LO signal power from -3dBm to +3dBm. The on-chip low-loss balun, along with an LO buffer, drives the double-balanced mixer. All interfacing and matching components from the LO inputs to the IF outputs are integrated on-chip.

High-Linearity Mixer

The core of the MAX9996 is a double-balanced, high-performance passive mixer. Exceptional linearity is provided by the large LO swing from the on-chip LO buffer. When combined with the integrated IF amplifiers, the cascaded IIP3, 2LO-2RF rejection, and NF performance is typically 26.5dBm, 72dBc, and 9.7dB, respectively.

Differential IF Output Amplifier

The MAX9996 mixer has a 40MHz to 350MHz IF frequency range. The differential, open-collector IF output ports require external pullup inductors to VCC. Note that these differential outputs are ideal for providing enhanced 2LO-2RF rejection performance. Single-ended IF applications require a 4:1 balun to transform the 200Ω differential output impedance to a 50Ω single-ended output. After the balun, the IF return loss is better than 15dB.

Applications Information

Input and Output Matching

The RF and LO inputs are internally matched to 50Ω. No matching components are required. Return loss at the RF port is typically 15dB over the entire input range (1700MHz to 2200MHz) and return loss at the LO ports is typically better than 16dB (1900MHz to 2400MHz). RF and LO inputs require only DC-blocking capacitors for interfacing.

The IF output impedance is 200Ω (differential). For evaluation, an external low-loss 4:1 (impedance ratio) balun transforms this impedance down to a 50Ω single-ended output (see the *Typical Application Circuit*).

Bias Resistors

Bias currents for the LO buffer and the IF amplifier are optimized by fine tuning resistors R1 and R2. If reduced current is required at the expense of performance, contact the factory for details. If the ±1% bias resistor values are not readily available, substitute standard ±5% values.

LEXT Inductor

LEXT serves to improve the LO-to-IF and RF-to-IF leakage. The inductance value can be adjusted by the user to optimize the performance for a particular frequency band. Since approximately 100mA flows through this inductor, it is important to use a low-DCR wire-wound coil.

If the LO-to-IF and RF-to-IF leakage are not critical parameters, the inductor can be replaced by a short circuit to ground.

Layout Considerations

A properly designed PC board is an essential part of any RF/microwave circuit. Keep RF signal lines as short as possible to reduce losses, radiation, and inductance. For the best performance, route the ground pin traces directly to the exposed pad under the package. The PC board exposed pad **MUST** be connected to the ground plane of the PC board. It is suggested that multiple vias be used to connect this pad to the lower level ground planes. This method provides a good RF/thermal conduction path for the device. Solder the exposed pad on the bottom of the device package to the PC board. The MAX9996 Evaluation Kit can be used as a reference for board layout. Gerber files are available upon request at www.maxim-ic.com.

Power-Supply Bypassing

Proper voltage-supply bypassing is essential for high-frequency circuit stability. Bypass each VCC pin and TAP with the capacitors shown in the *Typical Application Circuit*; see Table 1. Place the TAP bypass capacitor to ground within 100 mils of the TAP pin.

SiGe High-Linearity, 1700MHz to 2200MHz Downconversion Mixer with LO Buffer/Switch

Exposed Pad RF/Thermal Considerations

The exposed paddle (EP) of the MAX9996's 20-pin thin QFN-EP package provides a low thermal-resistance path to the die. It is important that the PC board on which the MAX9996 is mounted be designed to conduct heat from the EP. In addition, provide the EP with a low-inductance path to electrical ground. The EP **MUST**

be soldered to a ground plane on the PC board, either directly or through an array of plated via holes.

Chip Information

TRANSISTOR COUNT: 1414

PROCESS: SiGe BiCMOS

Table 1. Component List Referring to the Typical Application Circuit

COMPONENT	VALUE	DESCRIPTION
L1, L2	470nH	Wire-wound high-Q inductors (0805)
L3	10nH	Wire-wound high-Q inductor (0603)
C1	4pF	Microwave capacitor (0603)
C4	10pF	Microwave capacitor (0603)
C2, C6, C7, C8, C10, C12	22pF	Microwave capacitors (0603)
C3, C5, C9, C11	0.01μF	Microwave capacitors (0603)
C13, C14	150pF	Microwave capacitors (0603)
C15	150pF	Microwave capacitor (0402)
R1	806Ω	±1% resistor (0603)
R2	549Ω	±1% resistor (0603)
R3	7.15Ω	±1% resistor (1206)
T1	4:1 balun	IF balun
U1	MAX9996	Maxim IC

Pin Configuration/Functional Diagram

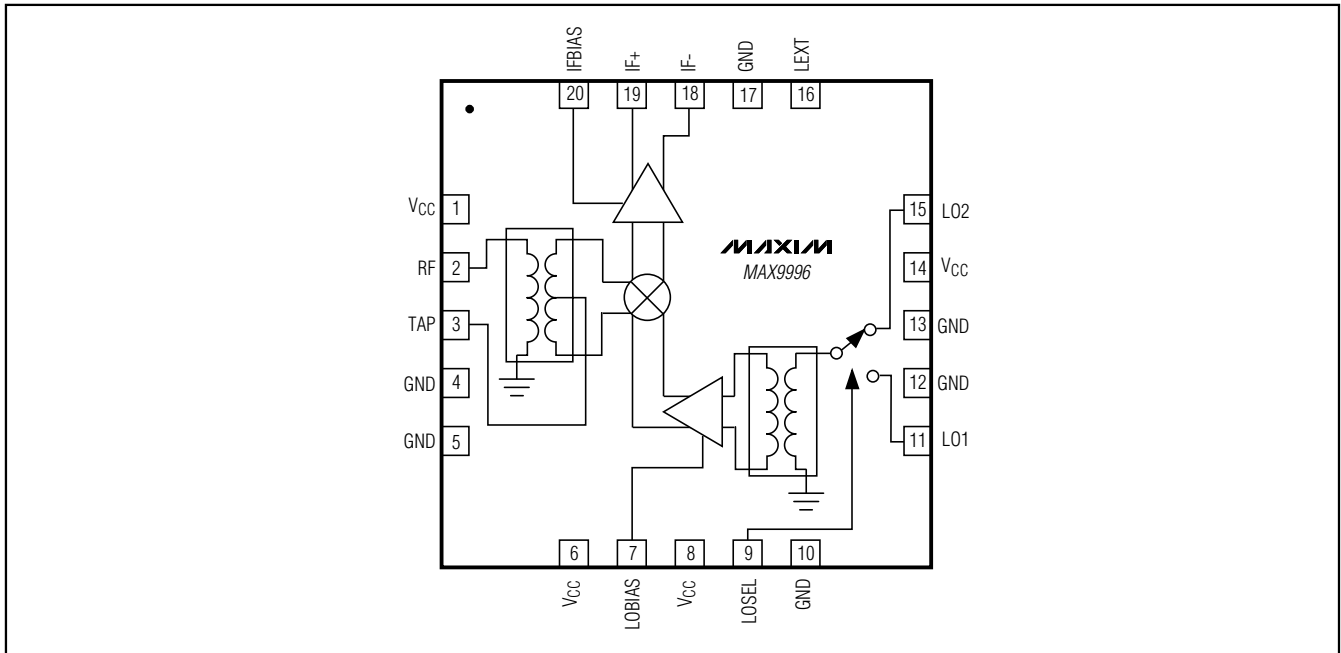

SiGe High-Linearity, 1700MHz to 2200MHz Downconversion Mixer with LO Buffer/Switch

Typical Application Circuit

MAX9996

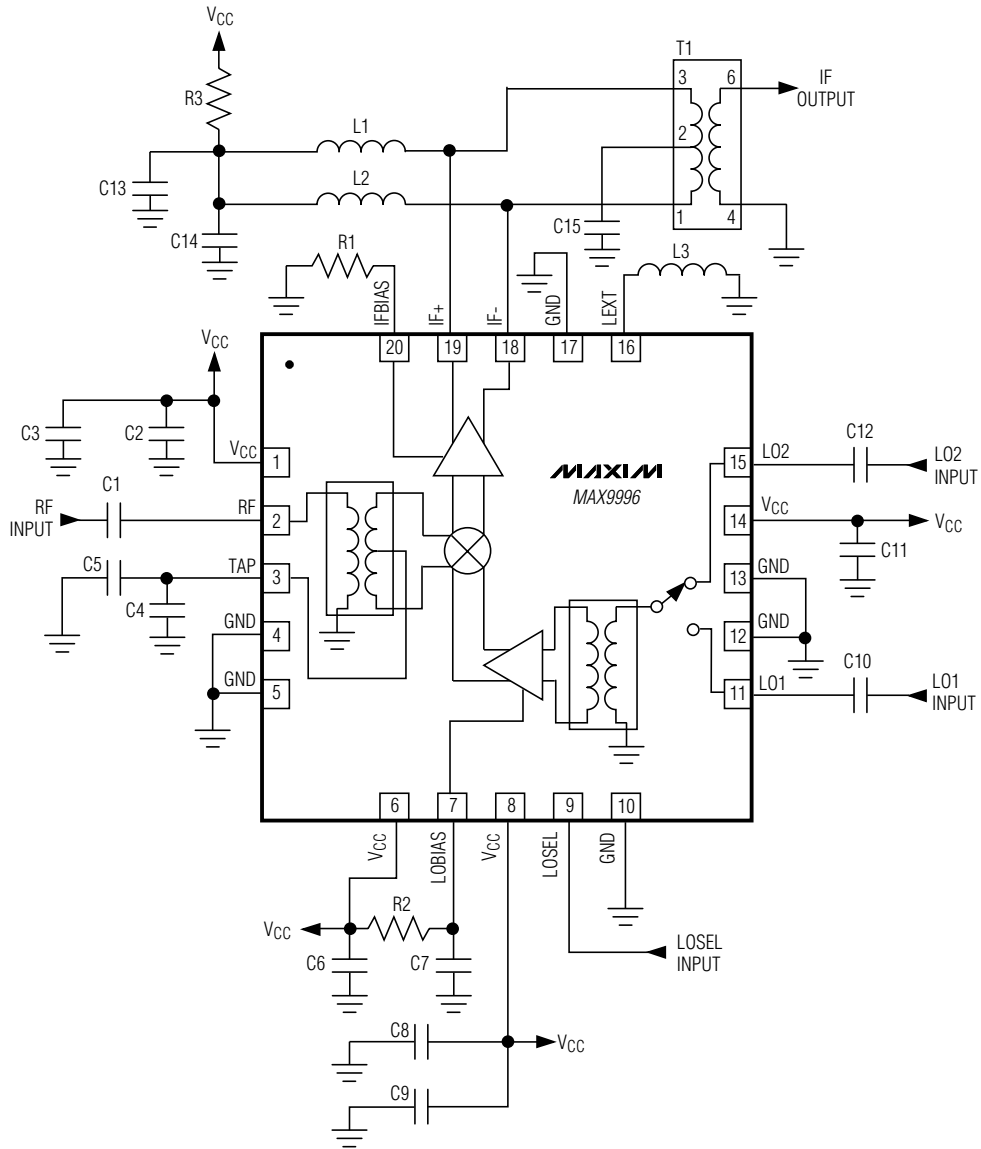

SiGe High-Linearity, 1700MHz to 2200MHz Downconversion Mixer with LO Buffer/Switch

Package Information

(The package drawing(s) in this data sheet may not reflect the most current specifications. For the latest package outline information go to www.maxim-ic.com/packages.)

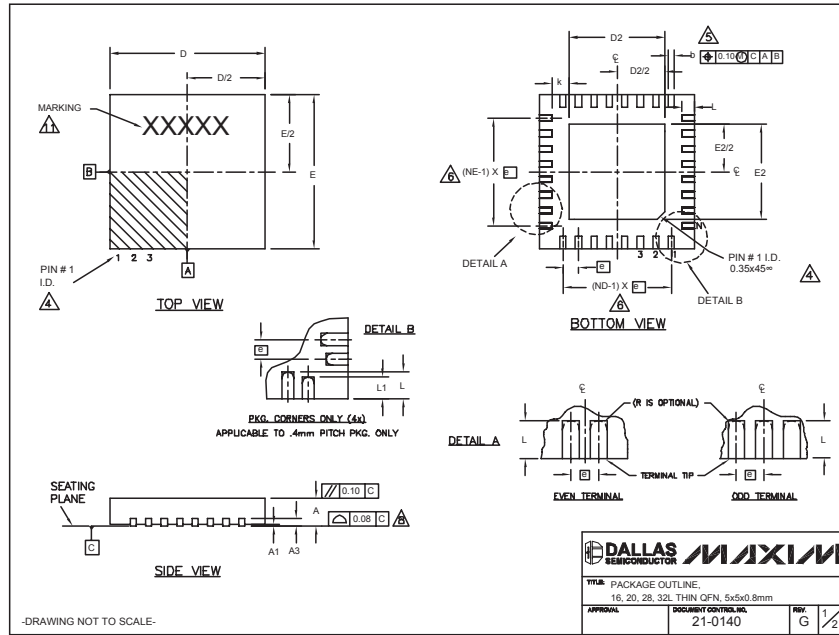

OFN THIN LEFS

COMMON DIMENSIONS									
PKG.	16L 5x5		20L 5x5		28L 5x5		32L 5x5		
SYMBOL	MIN.	NOM.	MAX.	MIN.	NOM.	MAX.	MIN.	NOM.	MAX.
A	0.70	0.75	0.80	0.70	0.75	0.80	0.70	0.75	0.80
A1	0	0.02	0.05	0	0.02	0.05	0	0.02	0.05
A3	0.20 REF.		0.20 REF.		0.20 REF.		0.20 REF.		
b	0.25	0.30	0.35	0.25	0.30	0.35	0.20	0.25	0.30
D	4.90	5.00	5.10	4.90	5.00	5.10	4.90	5.00	5.10
E	4.90	5.00	5.10	4.90	5.00	5.10	4.90	5.00	5.10
e	0.80 BSC.		0.65 BSC.		0.50 BSC.		0.50 BSC.		
k	0.25	-	-	0.25	-	-	0.25	-	-
L	0.30	0.40	0.50	0.45	0.55	0.65	0.30	0.40	0.50
L1	-	-	-	-	-	-	-	-	-
N	16		20		28		32		
ND	4		5		7		8		
NE	4		5		7		8		
JEDEC	WHHB		WHHC		WHHD-1		WHHD-2		

EXPOSED PAD VARIATIONS												
PKG. CODES	D2			E2			L	DOWN BONDS ALLOWED				
	MIN.	NOM.	MAX.	MIN.	NOM.	MAX.						
T1655-1	3.00	3.10	3.20	3.00	3.10	3.20	**	NO				
T1655-2	3.00	3.10	3.20	3.00	3.10	3.20	**	YES				
T1655N-1	3.00	3.10	3.20	3.00	3.10	3.20	**	NO				
T2055-2	3.00	3.10	3.20	3.00	3.10	3.20	**	NO				
T2055-3	3.00	3.10	3.20	3.00	3.10	3.20	**	YES				
T2055-4	3.00	3.10	3.20	3.00	3.10	3.20	**	NO				
T2055-5	3.15	3.25	3.35	3.15	3.25	3.35	0.40	Y				
T2855-1	3.15	3.25	3.35	3.15	3.25	3.35	**	NO				
T2855-2	2.60	2.70	2.80	2.60	2.70	2.80	**	NO				
T2855-3	3.15	3.25	3.35	3.15	3.25	3.35	**	YES				
T2855-4	2.60	2.70	2.80	2.60	2.70	2.80	**	YES				
T2855-5	2.60	2.70	2.80	2.60	2.70	2.80	**	NO				
T2855-6	3.15	3.25	3.35	3.15	3.25	3.35	**	NO				
T2855-7	2.60	2.70	2.80	2.60	2.70	2.80	**	YES				
T2855-8	3.15	3.25	3.35	3.15	3.25	3.35	0.40	Y				
T2855N-1	3.15	3.25	3.35	3.15	3.25	3.35	**	N				
T3255-2	3.00	3.10	3.20	3.00	3.10	3.20	**	NO				
T3255-3	3.00	3.10	3.20	3.00	3.10	3.20	**	YES				
T3255-4	3.00	3.10	3.20	3.00	3.10	3.20	**	NO				
T3255N-1	3.00	3.10	3.20	3.00	3.10	3.20	**	NO				

NOTES:

- DIMENSIONING & TOLERANCING CONFORM TO ASME Y14.5M-1994.
- ALL DIMENSIONS ARE IN MILLIMETERS. ANGLES ARE IN DEGREES.
- N IS THE TOTAL NUMBER OF TERMINALS.
- THE TERMINAL #1 IDENTIFIER AND TERMINAL NUMBERING CONVENTION SHALL CONFORM TO JEDEC 95-1 SPP-012. DETAILS OF TERMINAL #1 IDENTIFIER ARE OPTIONAL, BUT MUST BE LOCATED WITHIN THE ZONE INDICATED. THE TERMINAL #1 IDENTIFIER MAY BE EITHER A MOLD OR MARKED FEATURE.
- DIMENSION b APPLIES TO METALLIZED TERMINAL AND IS MEASURED BETWEEN 0.25 mm AND 0.30 mm FROM TERMINAL TIP.
- ND AND NE REFER TO THE NUMBER OF TERMINALS ON EACH D AND E SIDE RESPECTIVELY.
- DEPOPULATION IS POSSIBLE IN A SYMMETRICAL FASHION.
- COPLANARITY APPLIES TO THE EXPOSED HEAT SINK SLUG AS WELL AS THE TERMINALS.
- DRAWING CONFORMS TO JEDEC MO220, EXCEPT EXPOSED PAD DIMENSION FOR T2855-1, T2855-3 AND T2855-6.
- WARPAGE SHALL NOT EXCEED 0.10 mm.
- MARKING IS FOR PACKAGE ORIENTATION REFERENCE ONLY.
- NUMBER OF LEADS SHOWN ARE FOR REFERENCE ONLY.

APPROVAL: [Signature] DATE: 21-0140

Maxim cannot assume responsibility for use of any circuitry other than circuitry entirely embodied in a Maxim product. No circuit patent licenses are implied. Maxim reserves the right to change the circuitry and specifications without notice at any time.

12 **Maxim Integrated Products, 120 San Gabriel Drive, Sunnyvale, CA 94086 408-737-7600**