

NCP400

150 mA CMOS Low Iq Low-Dropout Voltage Regulator with Voltage Detector Output

The NCP400 is an integration of a low-dropout regulator and a voltage detector in a very small chip scale package. The voltage regulator is capable of supplying 150 mA with a low dropout of 160 mV at 100 mA. It contains a voltage reference unit, an error amplifier, comparators, PMOS power transistor, current limit and thermal shutdown protection circuits for the regulator portion.

A highly accurate voltage detector with hysteresis and an externally programmable time delay generator are implemented to prevent erratic system reset operation. It features complementary output with active low reset function.

The NCP400 is designed to work with low cost ceramic capacitors and requires only a small 1.0 μ F capacitor at regulator output. Its low quiescent current is ideal for battery powered applications.

Features

- LDO Voltage Regulator and Voltage Detector Together in a Very Small Wafer Level Package, 6 Bump Flip-Chip, 1.0 x 1.5 mm
 - Low Quiescent Current of 50 μ A Typical
 - Internal Current Limit and Thermal Shutdown Protection
 - Low Cost and Small Size Ceramic Capacitors
 - Input Voltage Range of 1.8 V to 5.0 V
 - Voltage Regulator
 - ◆ 1.8 V (*) Output with 2% Accuracy
 - ◆ Excellent Line and Load Regulation
 - ◆ Low Dropout of 160 mV at 100 mA
 - Voltage Detector
 - ◆ 2.3 V (*) Threshold with 2% Accuracy
 - ◆ Externally Programmable Time Delay Generator
 - ◆ Excellent Line and Load Regulation
 - This is a Pb-Free Device
- (*) Other voltages can be developed upon request.
Please contact your ON Semiconductor representative.

Typical Applications

- Memory Cards
- Cellular Phones
- Digital Still Cameras and Camcorders
- Battery Powered Equipment



ON Semiconductor®

<http://onsemi.com>

MARKING DIAGRAM

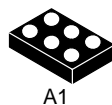

6 Bump
Flip-Chip
FC SUFFIX
CASE 499AH

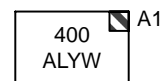

400 = Device Code
A = Assembly Location
L = Wafer Lot
Y = Year
W = Work Week

PIN CONNECTIONS

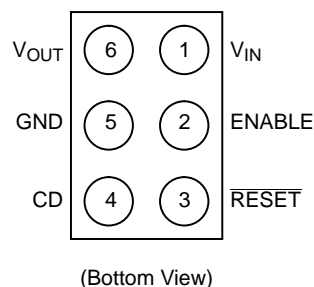

ORDERING INFORMATION

| Device | Package | Shipping† |
|-------------|------------------------|------------------|
| NCP400FCT2G | Flip-Chip (Pb-Free) | 3000 Tape & Reel |

†For information on tape and reel specifications, including part orientation and tape sizes, please refer to our Tape and Reel Packaging Specifications Brochure, BRD8011/D.

NCP400

TYPICAL OPERATION CIRCUIT

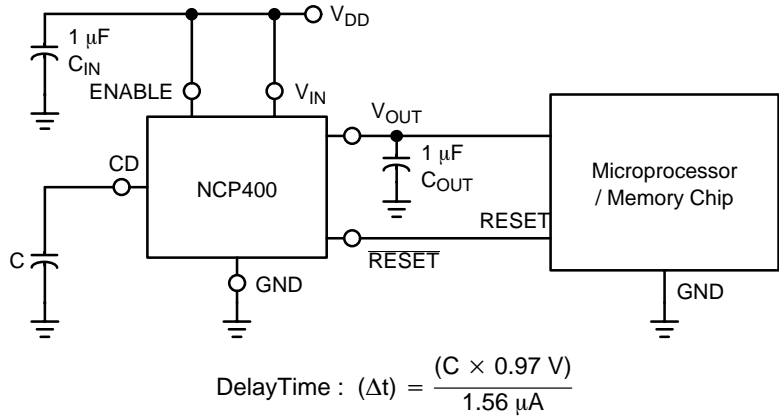

Figure 1. Power Supply and Reset Circuit for Microprocessor and/or Memory Chip

PIN DESCRIPTION

| Pin No. | Symbol | Description |
|---------|---------------------------|--|
| 1 | V_{IN} | Positive power supply input voltage. |
| 2 | ENABLE | This input is used to place the device into low-power standby. When this input is pulled low, the device is disabled. If this function is not used, ENABLE should be connected to V_{IN} . |
| 3 | $\overline{\text{RESET}}$ | Voltage detect output signal. |
| 4 | CD | Delay capacitor pin. |
| 5 | GND | Power supply ground. |
| 6 | V_{OUT} | Voltage regulator output voltage. |

REPRESENTATIVE BLOCK DIAGRAM

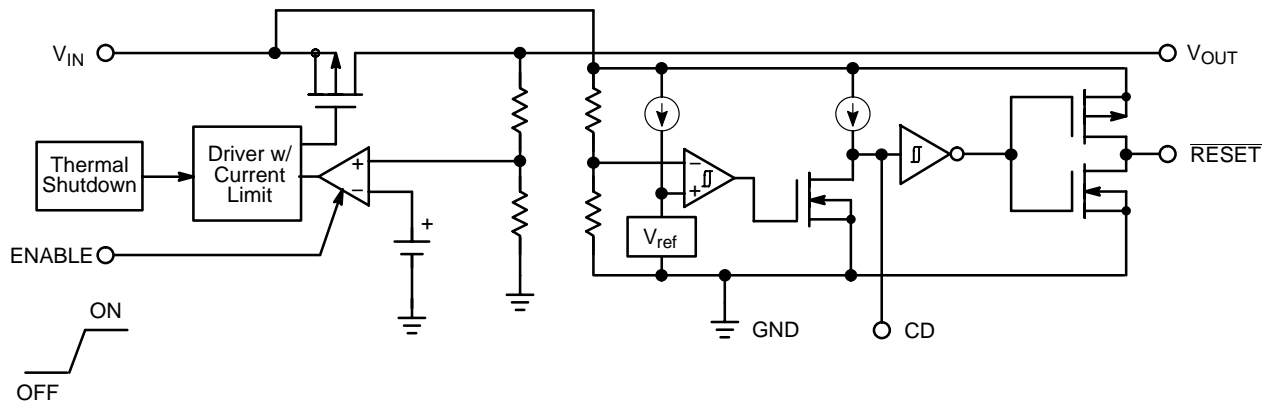

Figure 2. Representative Block Diagram

NCP400

ABSOLUTE MAXIMUM RATINGS

| Rating | Symbol | Value | Unit |
|--|-----------------|----------------------|------|
| Input Voltage | V_{IN} | 0 to 5.5 | V |
| Enable Voltage | ENABLE | -0.3 to $V_{IN}+0.3$ | V |
| Output Voltage | V_{OUT} | -0.3 to $V_{IN}+0.3$ | V |
| Delay Capacitor Pin Voltage | V_{CD} | -0.3 to $V_{IN}+0.3$ | V |
| Reset Pin Voltage | V_{reset} | -0.3 to $V_{IN}+0.3$ | V |
| Reset Pin Current | I_{reset} | 70 | mA |
| Power Dissipation and Thermal Characteristics for Microbump-6 Thermal Resistance Junction-to-Air (Note 3) | $R_{\theta JA}$ | Refer to Figure 22 | °C/W |
| Operating Junction Temperature | T_J | -40 to +125 | °C |
| Operating Ambient Temperature | T_A | -40 to +85 | °C |

Maximum ratings are those values beyond which device damage can occur. Maximum ratings applied to the device are individual stress limit values (not normal operating conditions) and are not valid simultaneously. If these limits are exceeded, device functional operation is not implied, damage may occur and reliability may be affected.

1. This device contains ESD protection and exceeds the following tests:
Human Body Model (HBM) ± 2000 V per MIL-STD-883, Method 3015
Machine Model (MM) ± 200 V.
2. Latchup capability (85°C) 100 mA DC with trigger voltage.
3. PCB top layer uses a single copper layer and is tested @ 250 mW.

NCP400

ELECTRICAL CHARACTERISTICS ($V_{IN} = V_{OUT(nom.)} + 1.0$ V, $ENABLE = V_{IN}$, $C_{IN} = 1.0$ μ F, $C_{OUT} = 1.0$ μ F, $T_A = 25^\circ$ C, unless otherwise noted.)

| Characteristic | Symbol | Min | Typ | Max | Unit |
|--|----------------------------|------------|--------------|------------|----------------|
| Input Voltage ($T_A = -40^\circ$ C to 85° C) | V_{IN} | 1.8 | – | 5.0 | V |
| Output Voltage ($T_A = 25^\circ$ C, $I_{OUT} = 1.0$ mA) | V_{OUT} | 1.764 | 1.8 | 1.836 | V |
| Output Voltage ($T_A = -40^\circ$ C to 85° C, $I_{OUT} = 1.0$ mA) | V_{OUT} | 1.746 | 1.8 | 1.854 | V |
| Line Regulation ($I_{OUT} = 10$ mA, $V_{IN} = 2.8$ V to 5.0 V) | Reg line | – | 1.0 | 3.5 | mV/V |
| Load Regulation ($I_{OUT} = 1.0$ mA to 150 mA) | Reg load | – | 0.3 | 0.8 | mV/mA |
| Maximum Output Current | $I_{OUT(nom.)}$ | – | 150 | – | mA |
| Dropout Voltage ($I_{OUT} = 100$ mA, Measured at $V_{OUT} -3.0\%$) | $V_{IN}-V_{OUT}$ | – | 160 | 200 | mV |
| Quiescent Current (Enable Input = 0V, $I_{OUT} = 0$ mA) (Enable Input = V_{IN} , $I_{OUT} = 1.0$ mA to $I_{o(nom.)}$) | I_{Q_SD} I_{Q_EN} | – – | 0.25 37 | 1.0 100 | μ A |
| Enable Input Threshold Voltage (Voltage Decreasing, Output Turns Off, Logic Low) (Voltage Increasing, Output Turns On, Logic High) | $V_{TH(EN)}$ | 0.17 – | 0.25 1.25 | – 1.65 | V |
| Output Short Circuit Current ($V_{OUT} = 0$ V, $V_{IN} = 5.0$ V) (Note 4) | $I_{OUT(MAX)}$ | 200 | 400 | 800 | mA |
| Ripple Rejection ($f = 1.0$ kHz, $I_o = 60$ mA) | RR | – | 50 | – | dB |
| Output Noise Voltage ($f = 20$ Hz to 100 kHz, $I_{OUT} = 60$ mA) | V_N | – | 110 | – | μ Vrms |
| Output Voltage Temperature Coefficient | T_C | – | ± 100 | – | ppm $^\circ$ C |
| Detector Threshold ($T_A = 25^\circ$ C) | V_{DET} | 2.254 | 2.30 | 2.346 | V |
| Detector Threshold Hysteresis | V_{HYS} | 0.069 | 0.115 | 0.161 | V |
| Reset Output Current N-Channel Sink Current (Reset = 0.5 V, $V_{IN} = 1.8$ V) P-Channel Source Current (Reset = 2.4 V, $V_{IN} = 4.5$ V) | I_{RESET} | 1.0 1.0 | 7.0 5.5 | – – | mA |
| CD Delay Pin Threshold Voltage (Pin 4) ($V_{IN}=2.0$ V) | $V_{TH(CD)}$ | 0.76 | 0.97 | 1.14 | V |
| Delay Capacitor Pin Sink Current (Pin 4) ($V_{IN} = 1.8$ V, $V_{CD} = 0.5$ V) | I_{CD_SINK} | 0.2 | 39 | – | mA |
| Delay Current Pin Source Current (Pin 4) ($V_{CD} = 0$, $V_{IN} = 2.8$ V) | I_{CD_SOURCE} | 0.78 | 1.56 | 3.12 | μ A |

4. Values are guaranteed by design.

TYPICAL CHARACTERISTICS

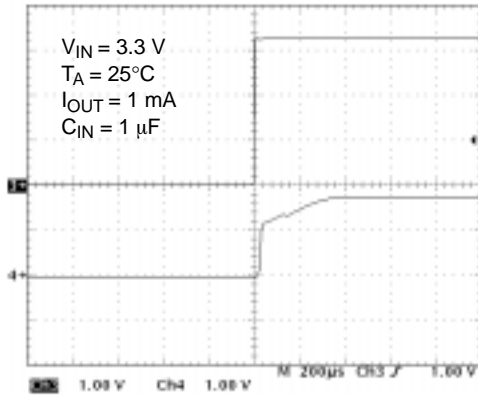

Upper Trace: Input Voltage 1 V/div
Lower Trace: Output Voltage 1 V/div

Figure 3. Turn-ON Response

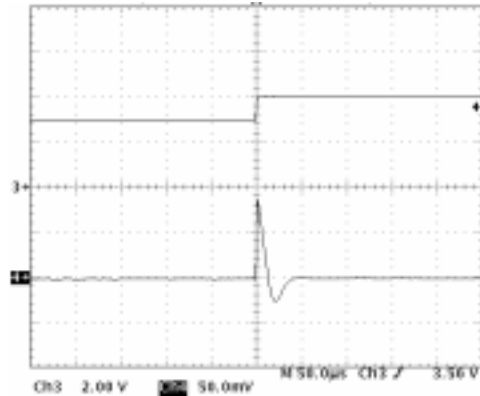

Upper Trace: Input voltage 2 V/div
Lower Trace: Output voltage 50 mV/div

Figure 4. Line Transient Response

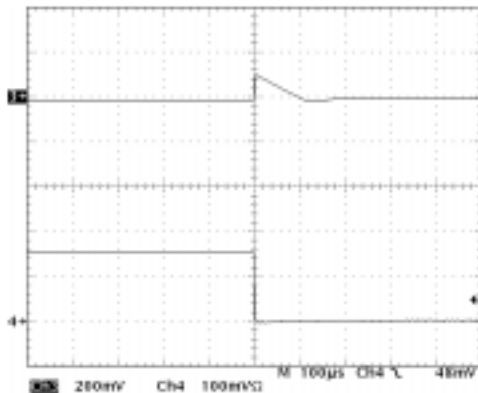

$I_{OUT} = 150 \text{ mA to } 1 \text{ mA}, V_{IN} = 3.3 \text{ V}, C_{IN} = 1 \mu\text{F}$
Upper Trace: Output Voltage 200 mV/div
Lower Trace: Output Loading Current 100 mA/div

Figure 5. Load Transient Response

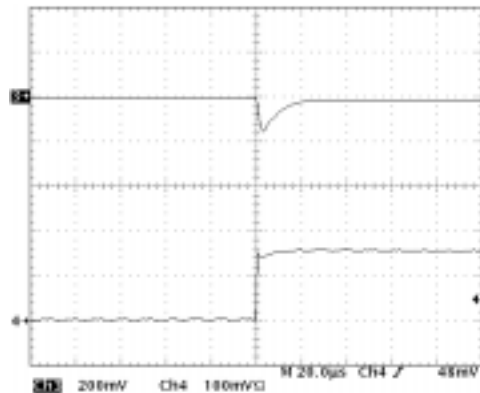

$I_{OUT} = 1 \text{ mA to } 150 \text{ mA}, V_{IN} = 3.3 \text{ V}, C_{IN} = 1 \mu\text{F}$
Upper Trace: Output Voltage 200 mV/div
Lower Trace: Output Loading Current 100 mA/div

Figure 6. Load Transient Response

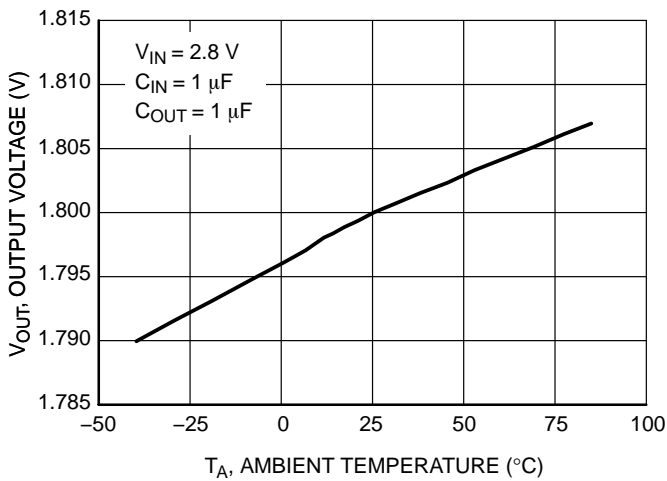

Figure 7. Output Voltage vs. Temperature

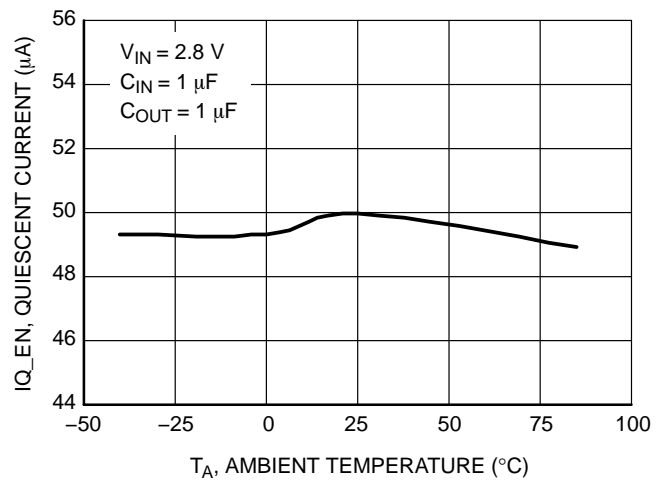

Figure 8. Quiescent Current (Enable) vs. Temperature

NCP400

TYPICAL CHARACTERISTICS

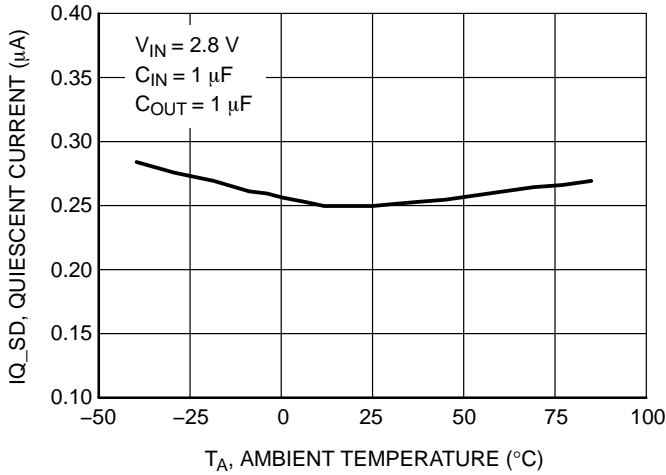

Figure 9. Quiescent Current (Shutdown) vs. Temperature

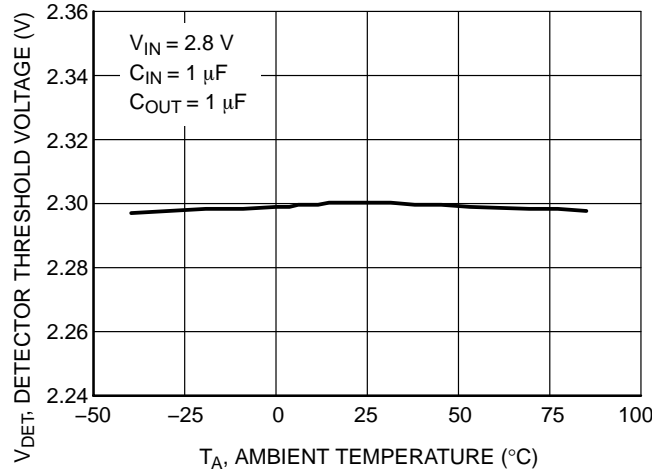

Figure 10. Detector Threshold Voltage vs. Temperature

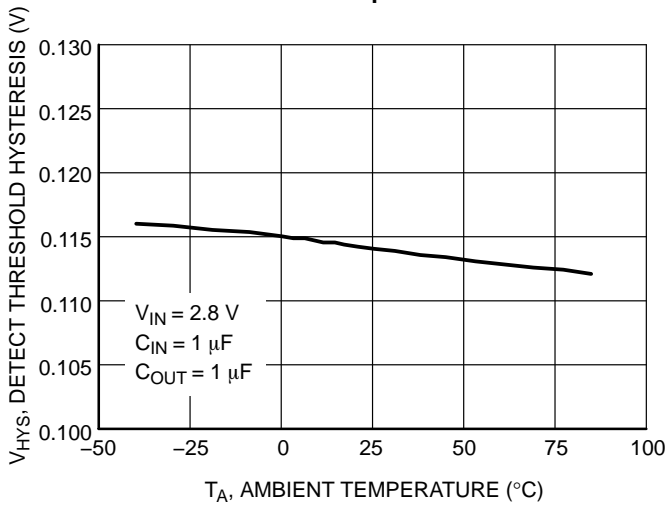

Figure 11. Detector Threshold Hysteresis Voltage vs. Temperature

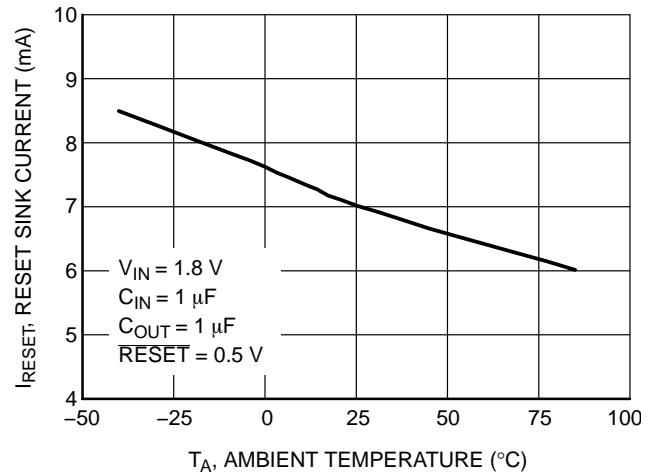

Figure 12. RESET Pin N-Channel Sink Current vs. Temperature

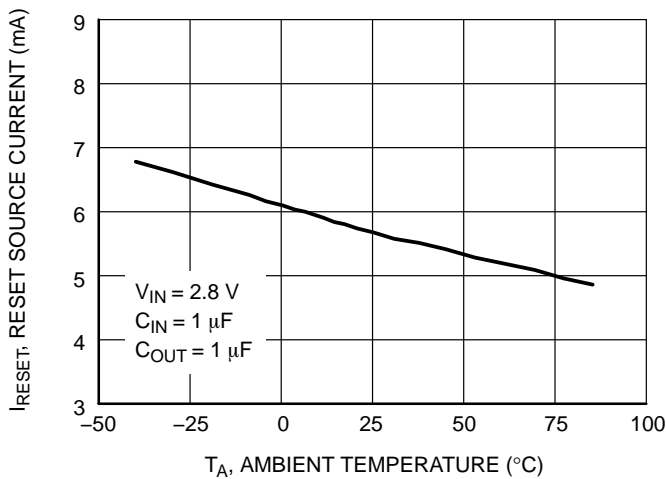

Figure 13. RESET Pin P-Channel Source Current vs. Temperature

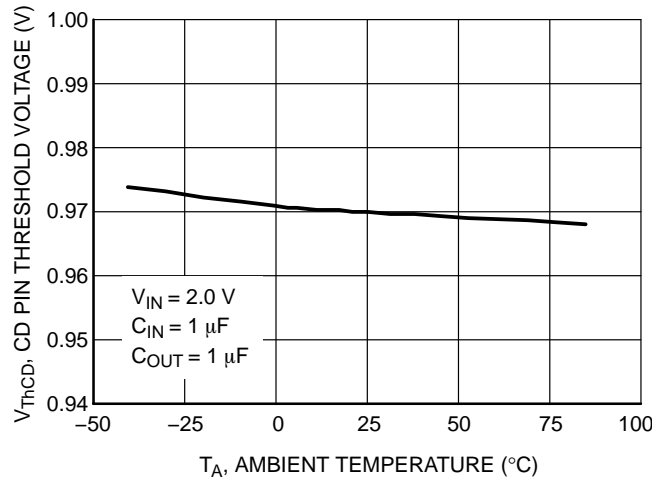

Figure 14. CD Delay Pin Threshold Voltage vs. Temperature

NCP400

TYPICAL CHARACTERISTICS

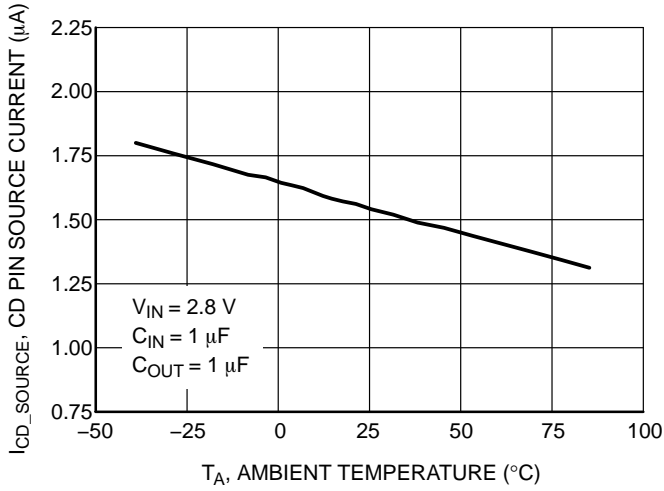

Figure 15. CD Pin Source Current vs. Temperature

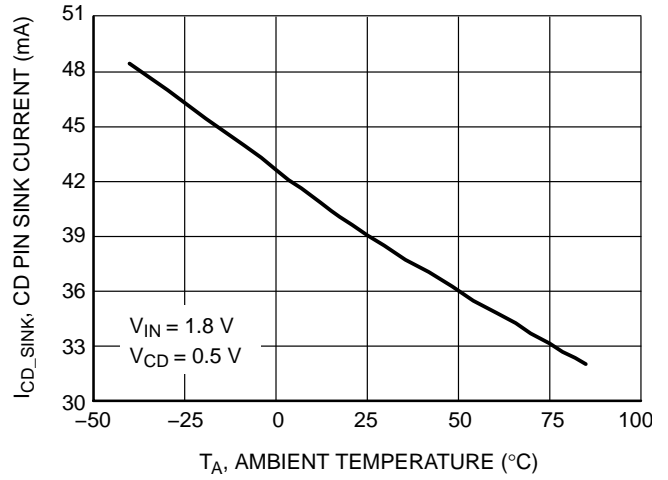

Figure 16. CD Pin Sink Current vs. Temperature

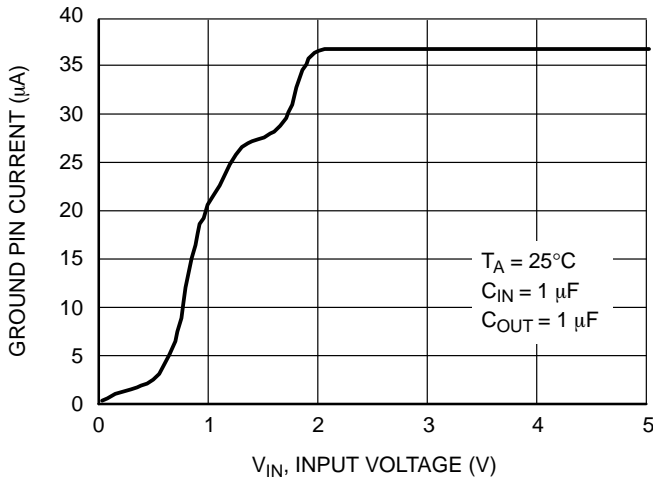

Figure 17. Ground Pin Current vs. Input Voltage

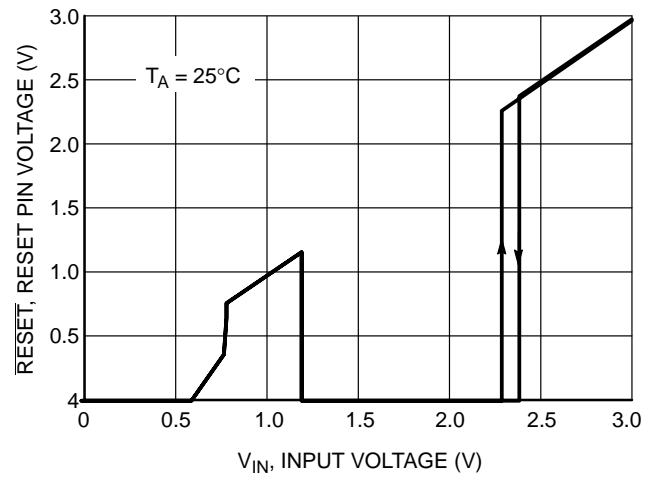

Figure 18. \overline{RESET} Pin Voltage vs. Input Voltage

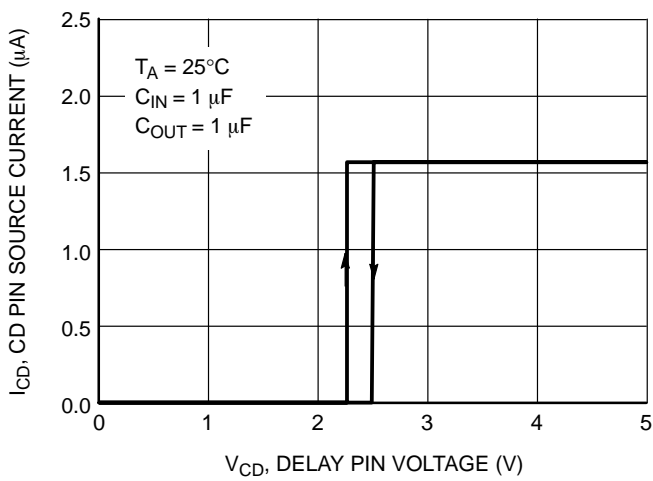

Figure 19. Delay Pin Source Current vs. Voltage

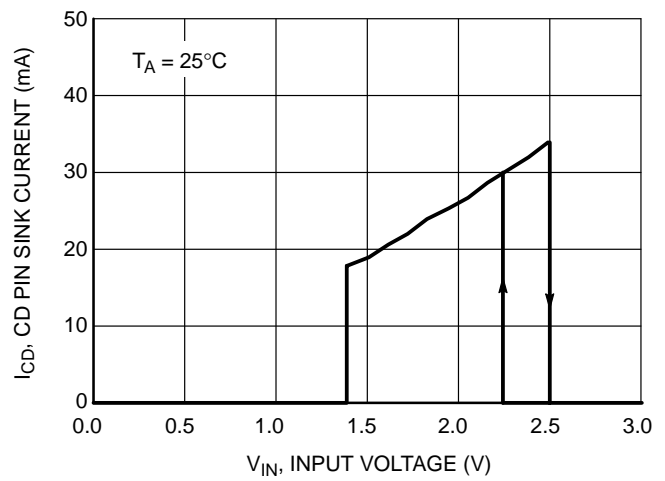

Figure 20. CD Pin Sink Current vs. Input Voltage

NCP400

TYPICAL CHARACTERISTICS

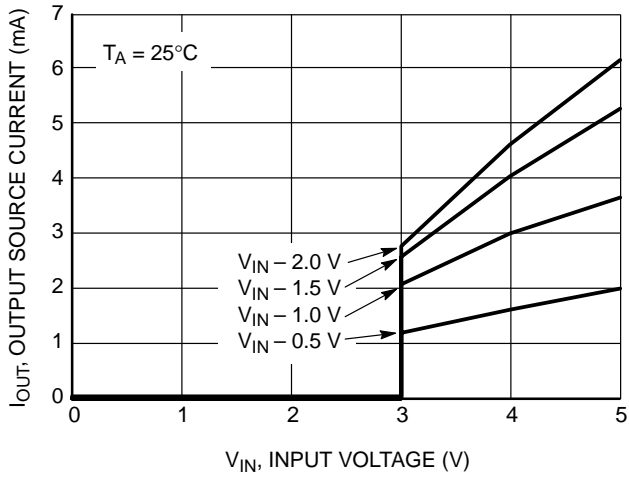

Figure 21. Reset Output Source Current vs. Input Voltage

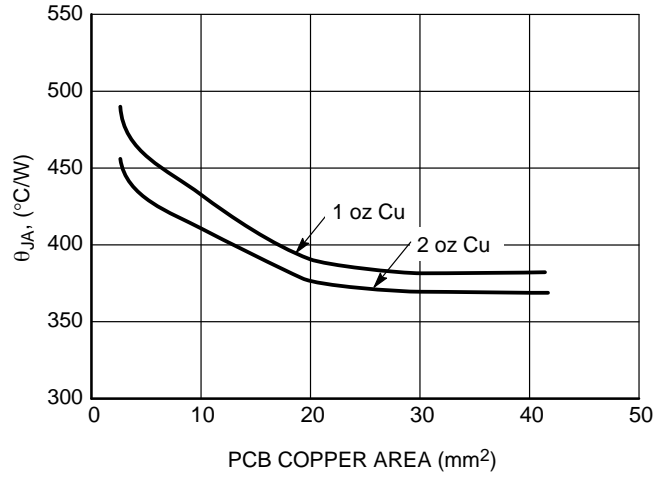

Figure 22. θ_{JA} vs. Copper Area

OPERATION DESCRIPTION

Low Dropout Voltage Regulator

The low dropout voltage regulator contains a voltage reference unit, an error amplifier, a PMOS power transistor, resistors for setting output voltage, current limit and thermal shutdown protection circuits.

Enable Operation

The enable pin will turn on or off the regulator. The limits of threshold are covered in the electrical specification section of this data sheet. If the enable is not used then the pin should be connected to V_{in} .

Voltage Detector

The NCP400 consist of a precision voltage detector that drives a time delay generator. Figures 23 and 24 show a timing diagram and a typical application. Initially consider that input voltage V_{in} is at a nominal level and it is greater than the voltage detector upper threshold (V_{DET+}). The

voltage at CD Pin (Pin 4) will be at the same level as V_{in} , and the reset output (Pin 3) will be in the high state. If there is a power interruption and V_{in} becomes significantly deficient, it will fall below the lower detector threshold (V_{DET-}) and the external time delay capacitor CD will be immediately discharged by an internal N-Channel MOSFET that connects to Pin 4. This sequence of events causes the Reset output to be in the low state. After completion of the power interruption, V_{in} will again return to its nominal level and become greater than the V_{DET+} . The voltage detector will turn off the N-Channel MOSFET and allow internal current source to charge the external capacitor CD, thus creating a programmable delay for releasing the reset signal. When the voltage at CD Pin 4 exceeds the inverter threshold, typically 0.97 V, the reset output will revert back to its original state. The detail reset output time delay calculation is shown in Figure 24.

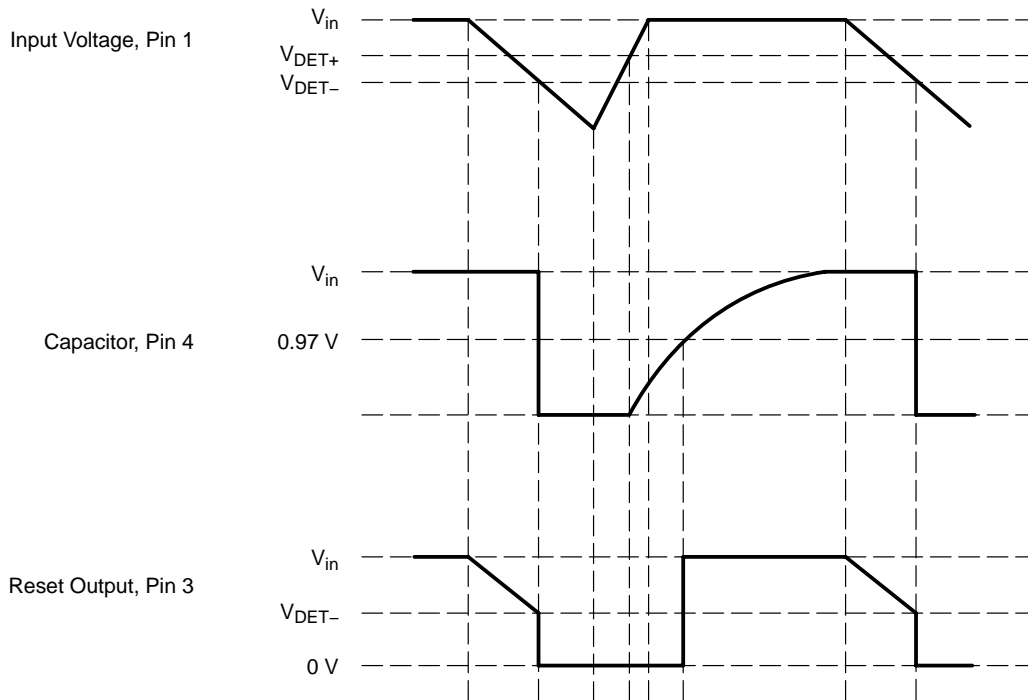

Figure 23. Timing diagram

NCP400

APPLICATION NOTES

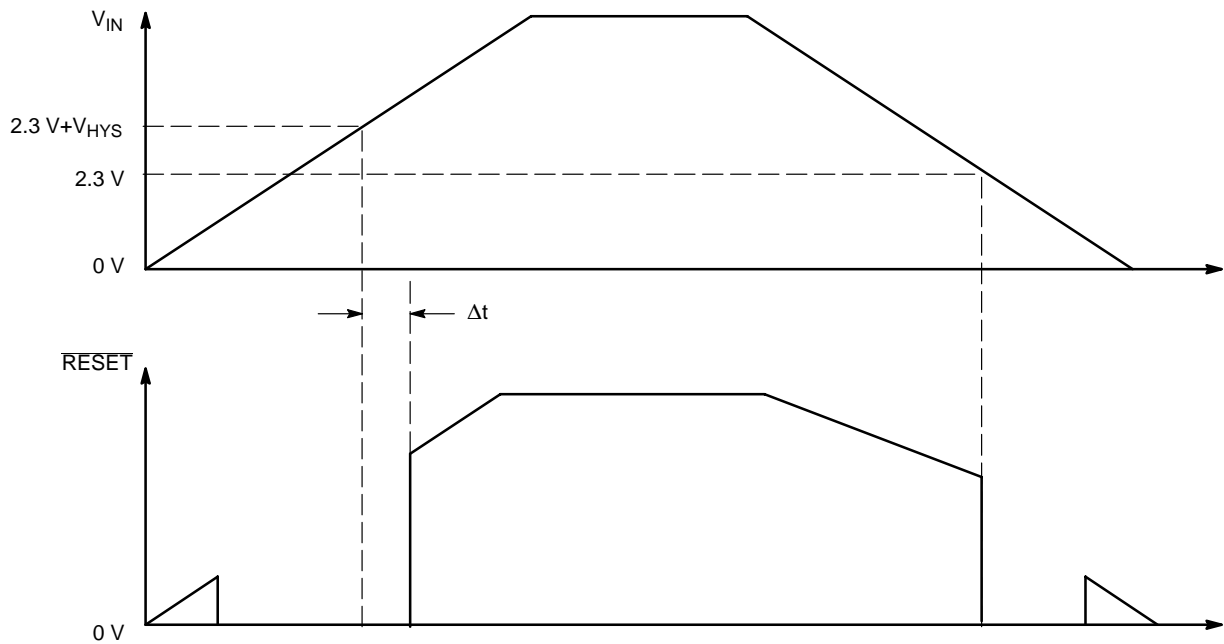

Figure 24. Timing Diagram

$$\text{Delay Time: } (\Delta t) = \frac{(C \times \Delta V_{ThCD})}{I_{CD}}$$

where: C is the CD pin capacitor
 ΔV_{ThCD} is the delay threshold voltage
 I_{CD} is delay current source.

As target use $C = 3300\text{ pF}$ and have $\Delta t = 2\text{ ms}$:

With internal $\Delta V_{ThCD} = 0.97\text{ V}$ and $I_{CD} = 1.56\text{ }\mu\text{A}$, then

$$\Rightarrow \text{Delay Time: } (\Delta t) = \frac{(3300\text{ pF} \times 0.97\text{ V})}{1.56\text{ }\mu\text{A}} = 2.05\text{ ms}$$

NCP400

APPLICATION INFORMATION

Low Dropout Voltage Regulator

–Input Decoupling

A 1.0 μF capacitor either ceramic or tantalum is recommended and should be connected close to the NCP400 package. Higher values and lower ESR will improve the overall line transient response.

–Output Decoupling

The NCP400 is a stable Regulator and does not require any specific Equivalent Series Resistance (ESR) or a

minimum output current. Capacitors exhibiting ESRs ranging from a few $\text{m}\Omega$ up to $10\ \Omega$ can thus safely be used. The minimum decoupling value is $1.0\ \mu\text{F}$ and can be augmented to fulfill stringent load transient requirements. The regulator accepts ceramic chip capacitors as well as tantalum devices. Larger values improve noise rejection and load regulation transient response. Figure 25 shows the stable area of the regulator with different output capacitor ESR and output current.

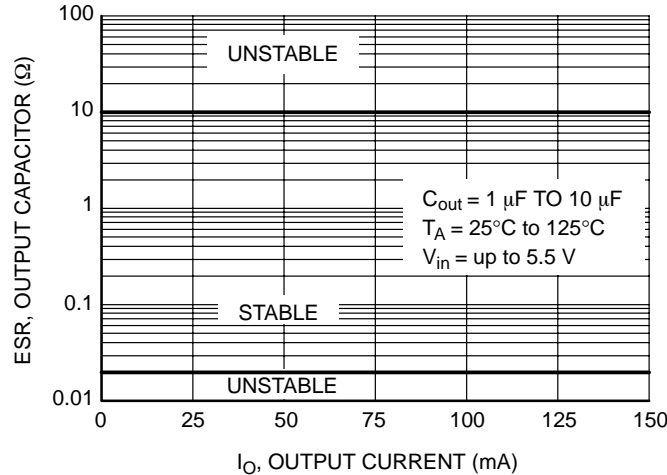

Figure 25. Output Capacitor versus Output Current

–Thermal Protection

Internal thermal shutdown circuit is provided to protect the integrated circuit in the event that the maximum junction temperature is exceeded. When the thermal protection activated, higher than 150°C , the regulator turns off. This feature is provided to prevent failures from accidental overheating.

–Hints

Please be sure the V_{in} and GND lines are sufficiently wide. When the impedance of these lines is high, there is a chance to pick up noise or cause the regulator to

malfunction. Set external components, especially the output capacitor, as close as possible to the circuit, and make leads a short as possible.

Voltage Detector

The voltage detector has built-in hysteresis to prevent erratic reset operation. This device is specifically designed for use as reset controllers in portable microprocessor based systems, it can offer a cost-effective solution in numerous applications where precise voltage monitoring and time delay are required. Figures 26 through 27 shows various application examples.

NCP400

APPLICATION CIRCUIT INFORMATION

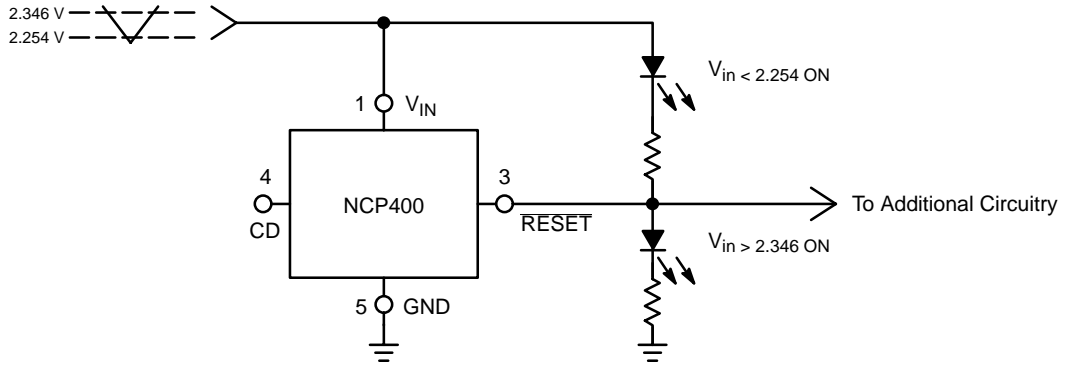
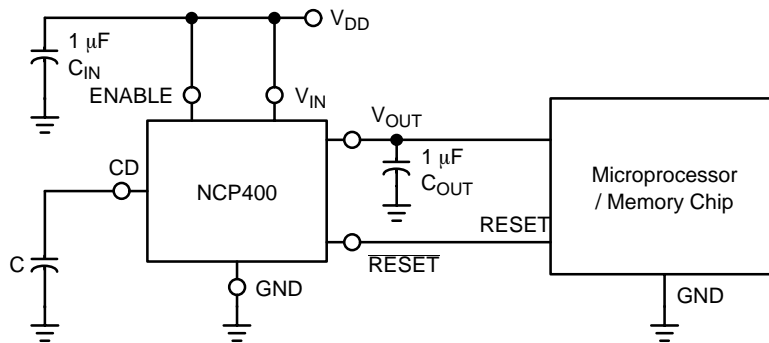

Figure 26. Input Voltage Indicator



$$\text{DelayTime} : (\Delta t) = \frac{(C \times 0.97 \text{ V})}{1.56 \mu\text{A}}$$

Figure 27. Microprocessor Reset Circuit

NCP400

PACKAGE DIMENSIONS

6 PIN FLIP-CHIP
CASE 499AH-01
ISSUE O

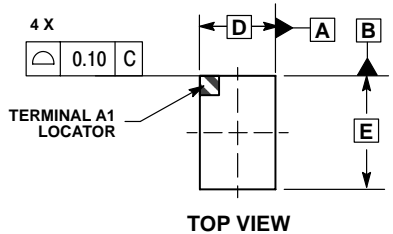

TOP VIEW

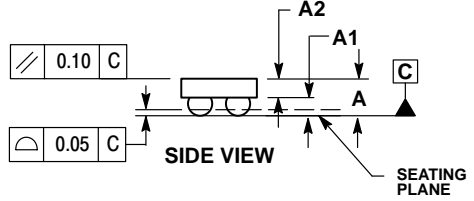

SIDE VIEW

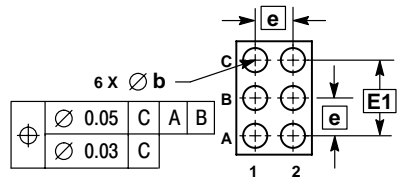

BOTTOM VIEW

- NOTES:
1. DIMENSIONING AND TOLERANCING PER ASME Y14.5M, 1994.
 2. CONTROLLING DIMENSION: MILLIMETERS.
 3. COPLANARITY APPLIES TO SPHERICAL CROWNS OF SOLDER BALLS.

| DIM | MILLIMETERS | |
|-----|-------------|-------|
| | MIN | MAX |
| A | 0.448 | 0.533 |
| A1 | 0.210 | 0.270 |
| A2 | 0.238 | 0.263 |
| D | 1.000 BSC | |
| E | 1.50 BSC | |
| b | 0.290 | 0.340 |
| e | 0.500 BSC | |
| E1 | 1.000 BSC | |

SOLDERING FOOTPRINT*

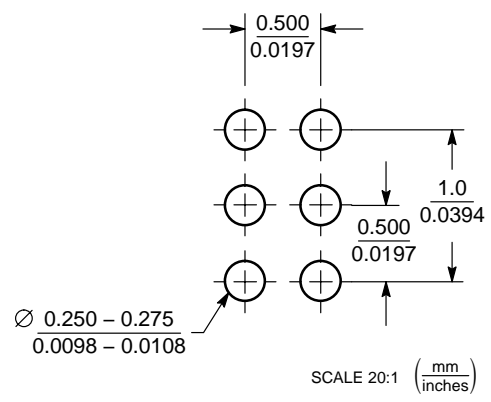

*For additional information on our Pb-Free strategy and soldering details, please download the ON Semiconductor Soldering and Mounting Techniques Reference Manual, SOLDERRM/D.

NCP400

ON Semiconductor and  are registered trademarks of Semiconductor Components Industries, LLC (SCILLC). SCILLC reserves the right to make changes without further notice to any products herein. SCILLC makes no warranty, representation or guarantee regarding the suitability of its products for any particular purpose, nor does SCILLC assume any liability arising out of the application or use of any product or circuit, and specifically disclaims any and all liability, including without limitation special, consequential or incidental damages. "Typical" parameters which may be provided in SCILLC data sheets and/or specifications can and do vary in different applications and actual performance may vary over time. All operating parameters, including "Typicals" must be validated for each customer application by customer's technical experts. SCILLC does not convey any license under its patent rights nor the rights of others. SCILLC products are not designed, intended, or authorized for use as components in systems intended for surgical implant into the body, or other applications intended to support or sustain life, or for any other application in which the failure of the SCILLC product could create a situation where personal injury or death may occur. Should Buyer purchase or use SCILLC products for any such unintended or unauthorized application, Buyer shall indemnify and hold SCILLC and its officers, employees, subsidiaries, affiliates, and distributors harmless against all claims, costs, damages, and expenses, and reasonable attorney fees arising out of, directly or indirectly, any claim of personal injury or death associated with such unintended or unauthorized use, even if such claim alleges that SCILLC was negligent regarding the design or manufacture of the part. SCILLC is an Equal Opportunity/Affirmative Action Employer. This literature is subject to all applicable copyright laws and is not for resale in any manner.

PUBLICATION ORDERING INFORMATION

LITERATURE FULFILLMENT:

Literature Distribution Center for ON Semiconductor
P.O. Box 61312, Phoenix, Arizona 85082-1312 USA

Phone: 480-829-7710 or 800-344-3860 Toll Free USA/Canada

Fax: 480-829-7709 or 800-344-3867 Toll Free USA/Canada

Email: orderlit@onsemi.com

N. American Technical Support: 800-282-9855 Toll Free
USA/Canada

Japan: ON Semiconductor, Japan Customer Focus Center
2-9-1 Kamimeguro, Meguro-ku, Tokyo, Japan 153-0051
Phone: 81-3-5773-3850

ON Semiconductor Website: <http://onsemi.com>

Order Literature: <http://www.onsemi.com/litorder>

For additional information, please contact your
local Sales Representative.