

# Agilent ACMD-7401 Miniature PCS Band Duplexer Data Sheet



## Description

The ACMD-7401 is a miniaturized duplexer designed using Agilent's Film Bulk Acoustic Resonator (FBAR) technology. The ACMD-7401 is the first duplexer built with Agilent's innovative Microcap bonded-wafer chip scale packaging technology. This process allows the ultra small filters to be assembled in a molded chip-on-board (MCOB) module that is less than 1.4 mm high with a 5 x 5 mm footprint.

The ACMD-7401 enhances the sensitivity and dynamic range of CDMA receivers, providing more than 50 dB attenuation of transmitted signal at the receiver input, and

more than 40 dB rejection of the transmit-generated noise in the receive band. Typical insertion loss in the Tx channel is only 1.8 dB, minimizing current drain from the power amplifier. Typical insertion loss in the Rx channel is 2.2 dB, improving receiver sensitivity.

Agilent's thin-film Bulk Acoustic Resonator (FBAR) technology makes possible high-Q filters at a fraction their usual size. The excellent power handling of the bulk-mode resonators supports the high output powers needed in PCS handsets, with virtually no added distortion.

## Features

- **Miniature size: less than 1.4 mm high, 5 x 5 mm footprint**
- **Rx Band: 1930 – 1990 MHz typical performance:**
  - Rx Noise Blocking: 44 dB**
  - Insertion Loss: 2.2 dB typical, 3.0 dB band edge**
- **Tx Band: 1850 – 1910 MHz typical performance:**
  - Tx Interferer Blocking: 54 dB**
  - Insertion Loss: 1.8 dB typical, 2.5 dB band edge**
- **30 dBm Tx Power Handling**

## Applications

- **Handsets or data terminals operating in the US PCS frequency band**



**ACMD-7401 Electrical Specifications,  $Z_0 = 50\Omega$ ,  $T_C^{[1]}$  as indicated**

Symbol	Parameters	Units	+25°C <sup>[1,3]</sup>			+85°C <sup>[1,2,3,4]</sup>			-30°C <sup>[1,2,3]</sup>		
			Min	Typ	Max	Min	Typ	Max	Min	Typ	Max
<b>Path from Antenna Port to Receiver Port</b>											
S23	Attenuation in Transmit Band (1850.6–1909.4 MHz)	dB	50	54	—	50	52	—	50	52	—
S23	Insertion Loss, lower band edge (1930.6–1935 MHz)	dB	—	2.6	3.5	—	2.7	3.5	—	3.2	4.5
S23	Insertion Loss, mid-band (1935–1987 MHz)	dB	—	2.2	3.5	—	32.3	3.0	—	2.2	3.5
S23	Insertion Loss, upper band edge (1987–1989.4 MHz)	dB	—	2.8	3.5	—	2.8	3.8	—	2.7	3.5
$\Delta$ S23	Ripple in Receive Band	dB	—	1.5	2.6	—	1.5	3.0	—	2.0	3.0
S22	Rx Port Return Loss in Receive Band	dB	8.0	10	—	8.0	10	—	8.0	10	—
<b>Path from Transmitter Port to Antenna Port</b>											
S31	Attenuation in Receive Band (1930.6–1935 MHz)	dB	40	44	—	40	42	—	37	42	—
S31	Attenuation in Receive Band (1935–1989.4 MHz)	dB	40	42	—	40	42	—	40	42	—
S31	Insertion Loss, lower band edge (1850.6–1853 MHz)	dB	—	2.3	3.0	—	2.3	3.0	—	2.3	3.6
S31	Insertion Loss, mid-band (1853–1907 MHz)	dB	—	2.2	3.0	—	2.2	3.0	—	2.2	3.0
S31	Insertion Loss, upper band edge (1907–1909.4 MHz)	dB	—	1.6	3.0	—	2.4	3.8	—	1.2	3.0
$\Delta$ S31	Ripple in Transmit Band	dB	—	2.0	2.5	—	2.0	3.0	—	2.0	3.0
S11	Tx Port Return Loss in Transmit Band	dB	8.0	10	—	8.0	10	—	8.0	10	—
S33	Antenna Port Return Loss, Tx and Rx bands	dB	8.0	10	—	8.0	10	—	8.0	10	—
S21	Tx-Rx Isolation, 1850.6–1909.4 MHz (Transmit Band)	dB	50	54	—	50	54	—	50	54	—
S21	Tx-Rx Isolation, 1930.6–1935 MHz (Receive Band)	dB	40	44	—	40	44	—	38	44	—
S21	Tx-Rx Isolation, 1935–1989.4 MHz (Receive Band)	dB	40	44	—	40	44	—	40	44	—

**Notes:**

- $T_C$  is defined as case temperature, the temperature of the underside of the duplexer where it makes contact with the circuit board. Port 1 = Tx, Port 2 = Rx, Port 3 = Ant
- Specifications are given at operating temperature limits and room temperature. To estimate performance at some intermediate temperature, use linear interpolation.
- Specifications are guaranteed over the given temperature range, with the input power to the Tx port equal to +29 dBm (or lower) over all Tx frequencies. Upper transmit band edge maximum Insertion Loss at 85°C is guaranteed to +26 dBm of input power. For higher input power, derate maximum temperature as:  $T_{max} = 95^\circ\text{C} - 25^\circ\text{C} * P_{in}$  (Watts). Input power between +26 dBm and +30 dBm is safe, but the Insertion Loss at the upper transmit band edge will degrade slightly.
- High temperature specifications are guaranteed with thermal pads in thermal contact with the motherboard. (See Figure 1.)

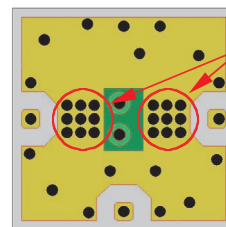

Thermal Pads ensure good thermal contact to the motherboard.

**Figure 1. Underside of the duplexer.**

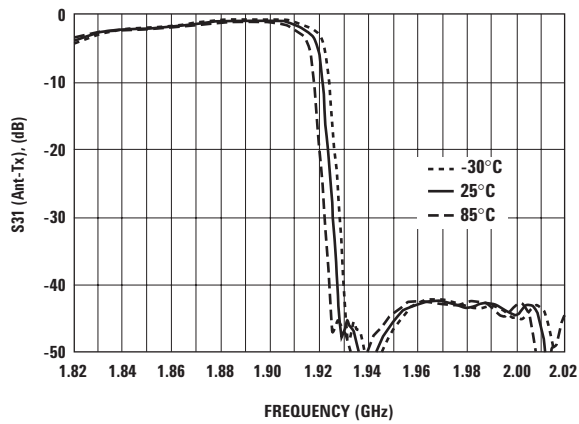

Figure 2. Loss, Tx port to antenna port.

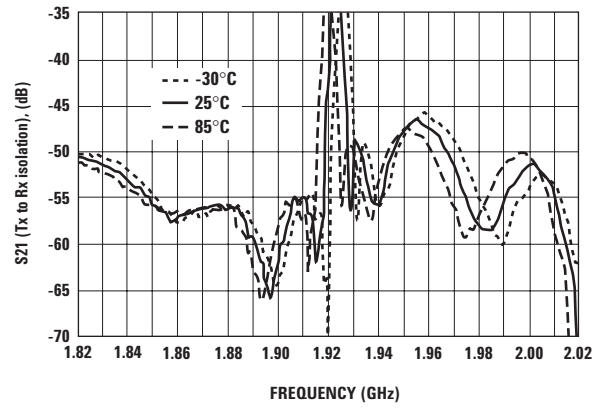

Figure 3. Isolation (Tx to Rx ports).

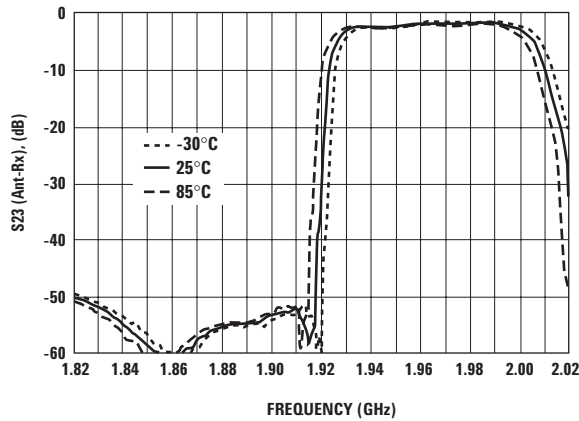

Figure 4. Loss, antenna port to Rx port.

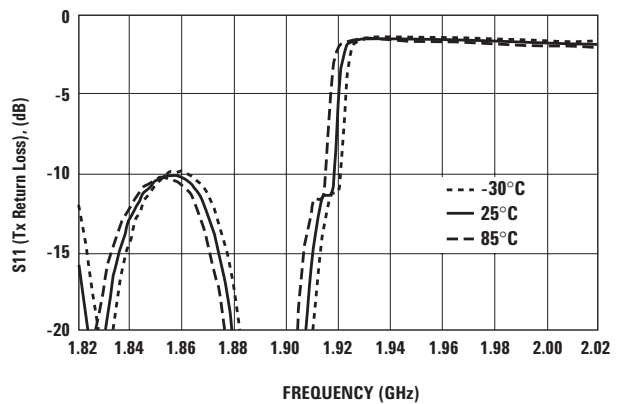

Figure 5. Return Loss, Tx port.

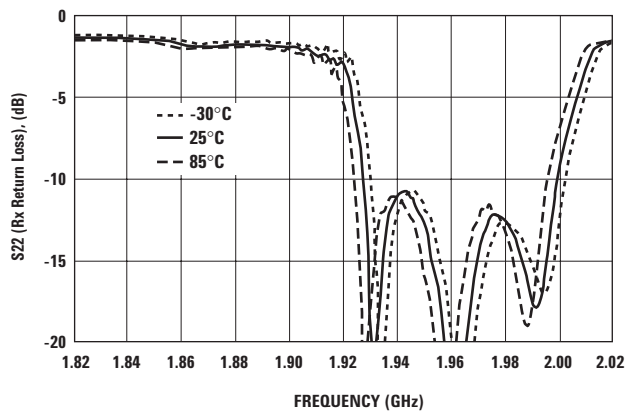

Figure 6. Return loss, Rx port.

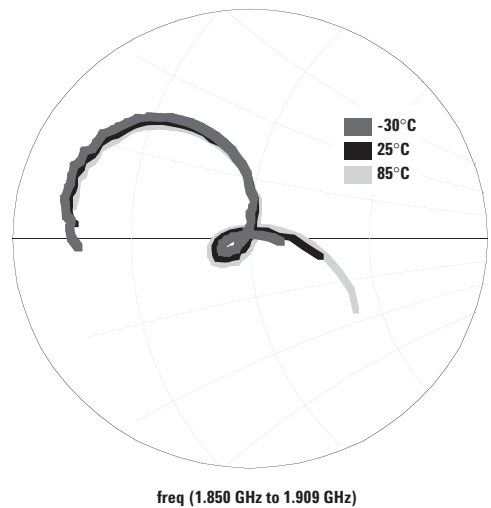

Figure 7. Tx port impedance (8 dB circle).

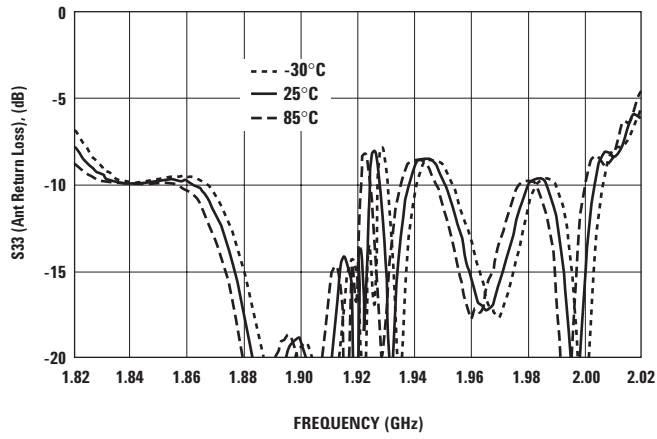

Figure 8. Return loss, antenna port.

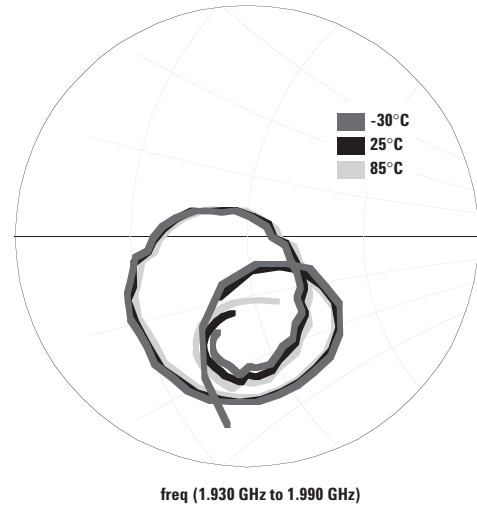

Figure 9. Rx port impedance (8 dB circle).

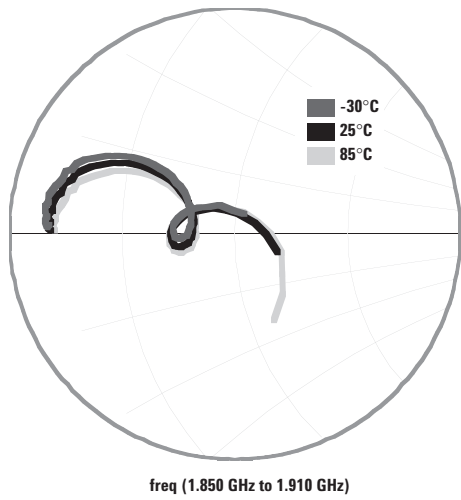

Figure 10. Antenna port impedance, Tx band (8 dB circle).

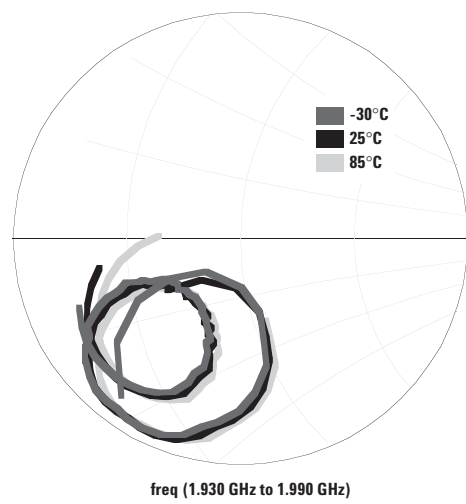

Figure 11. Antenna port impedance, Rx band (8 dB circle).

## Applications Information

Agilent's ACMD-7401 duplexers provide high RF performance in a very small package. However, in order to achieve all the performance available from the duplexer, care must be taken in the design of the board onto which it is mounted. The purpose of this information is to provide Agilent's recommendations on the design of that board (called the motherboard in this note).

Areas where care in design must be observed are **thermal ground**, **RF ground**, **in/out connection design**, and **solder mask/solder stencil design**. These four design areas, which are sometimes interrelated, will be considered one at a time below.

### Thermal Ground

FBAR resonators have a negative temperature coefficient of frequency – as temperature goes up, the frequency response of the filter shifts down in frequency. See Figure 12. Typical coefficients are 57 KHz/°C for the Tx filter and 40 KHz/°C for the Rx filter. In Figure 13, the same data are presented with the scale narrowed down to the upper end of the Tx band. Note that all these data are taken at low input power levels (+10 dBm).

When input power is +29 dBm, heating in the Tx filter due to RF losses causes the filter membranes to heat up beyond 85°C. This, in turn, causes the filter response to shift further left (down in frequency), resulting in increased insertion loss at the high end of the Tx band (1910 MHz). Agilent Technologies takes this into account in the manufacture and final test of the duplexer – all specifications for insertion loss

(and other parameters) will be met at the specified input power level and motherboard temperature. Note that high power/high temperature testing done at Agilent is performed with the duplexer soldered down to a test board having a very good heat sink.

The motherboard must be designed to remove heat from the duplexer with the lowest possible thermal resistance. Mount the duplexer on a large surface of 1/2 ounce copper ground plane (as shown in Figure 14), to enable

the heat to be removed in all directions. Via holes, necessary for RF grounding, should be filled with copper plating to further remove heat from the duplexer's Tx filter and dump it into a second ground plane located in a lower layer of the motherboard.

FBAR duplexers have extremely low thermal mass and must be properly heat sunk, as well as isolated from external sources of heat (such as a nearby power amplifier). Failure to provide an adequate thermal design to cool

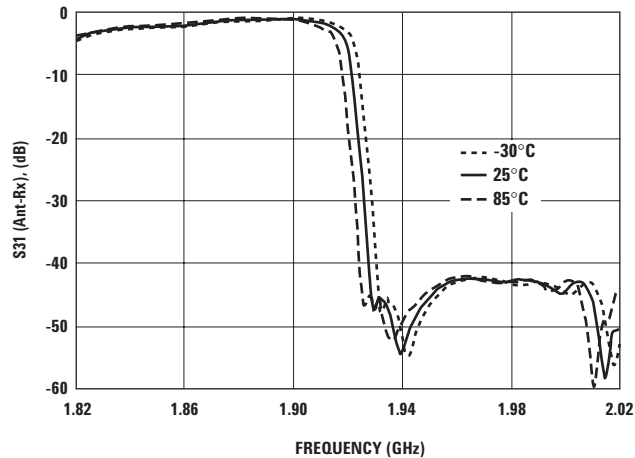

Figure 12. Tx Filter Response with Temperature.

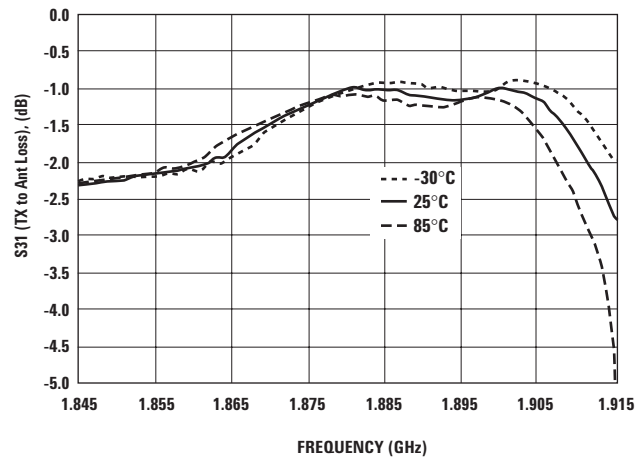

Figure 13. Tx Filter Response with Temperature (expanded).

the duplexer may result in degradation of insertion loss at the high end of the Tx band, or other performance issues.

### RF Ground

Many of the same considerations, which apply to the thermal ground plane, also apply to the RF ground plane. A large surface ground area, as shown in Figure 14, provides data sheet performance for the duplexer. In addition, a series of 56 (or more) plated

and plugged via holes to a lower ground plane (0.25 to 0.30 mm in diameter) should be provided under the perimeter of the duplexer, as shown in Figure 15.

The rectangular opening in the center of the duplexer ground plane (Figure 15) is strongly suggested. The 5 mm x 5 mm miniature FBAR duplexer has two via hole openings on the underside. They are DC insulated from any ground plane with a

patch of solder mask, but RF coupling to the ground may affect duplexer performance. Agilent Technologies recommends that the user remove the ground in the 1.0 x 1.4 mm rectangle shown. Note that the mounting includes a solder mask frame, 4.6 mm x 4.6 mm (shown in green). This solder mask assists with the alignment of the duplexer during soldering.

Details of the input/output pads are shown in Figure 16.

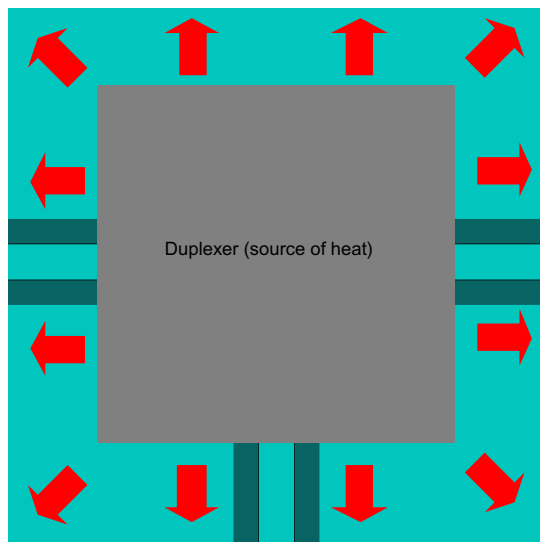

Figure 14. Thermal and Electrical Ground Plane.

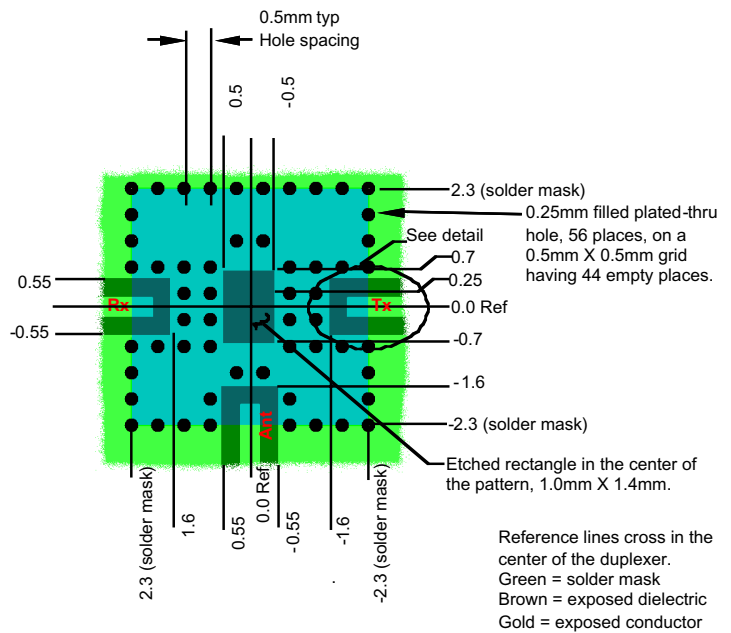

Figure 15. Thermal and Electrical Ground Plane Details.

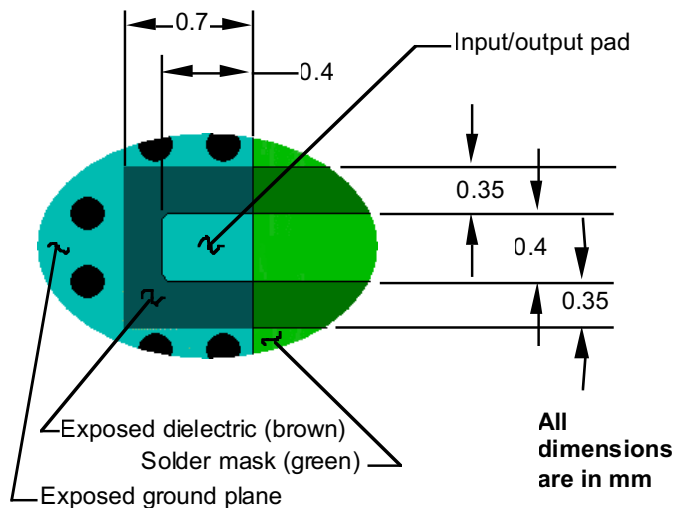

Figure 16. Detail of Input/output Pads.

### In/out Connection Design

High isolation between ports is a characteristic of Agilent FBAR duplexers, and values often exceed 50 dB. To achieve these isolation numbers, the user's motherboard must have 60 dB or more of isolation between each pair of the three input/output lines. This is measured as shown in Figure 17, using copper pins to short out all three of the lines to ground. Isolation is then measured between the Tx, Rx and Ant lines, with 60 dB as a minimum acceptable level.

In order to achieve 60 dB of isolation in the motherboard itself using microstrip transmission lines, extreme care must be taken in the design due to the poorly contained field lines in microstrip. Ground areas between the lines and other good techniques will have to be used.

The use of coplanar waveguide over a groundplane (CPWG) provides for higher line-to-line isolation.

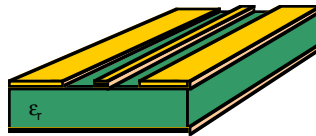

CPWG (Coplanar waveguide)

Design guidelines for CPWG transmission lines can be found in AppCAD, the design/analysis software found on the Web at <http://www.agilent.com/view/appcad>

Better performance can be obtained using symmetrical stripline, where a buried conductor has a ground plane above and below.

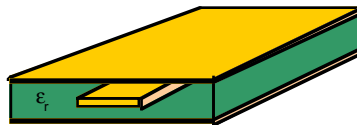

Stripline

Such transmission lines have excellent shielding, and line-to-line values in excess of 80 dB can easily be achieved using this transmission line. Via holes are used to bring the signal down to the stripline conductor from the in/out pads on the surface.

In order to obtain the maximum isolation between lines in the buried stripline layer, fill in the area between lines with large patches of copper, connected to the upper (and other) ground planes.

### Solder Mask and Solder Stencil

Solder mask is used on all motherboards, to prevent solder from adhering to places where it is not desired. In mounting the duplexer, it serves as an aid to alignment during reflow soldering.

The motherboard solder mask (shown in green in Figures 15, 16 and 17) is 4.6 mm x 4.6 mm, slightly smaller than the duplexer and corresponding to the metal pattern on the underside. This will contain the solder during reflow, and prevent the duplexer from rotating or slipping out of alignment while it is floating on molten solder.

A solder stencil is used to print a pattern of solder paste onto the motherboard, with the duplexer placed upon this paste before the reflow process begins. The design of the solder stencil is critical to obtaining good yields in reflow soldering.

The solder stencil pattern recommended by Agilent Technologies is shown in Figure 18, along with the recommended opening in the solder mask on the top surface.

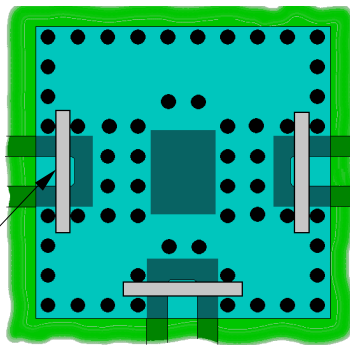

Shorting pin, soldered to in/out pad and to ground on both sides, three places.

Figure 17. Motherboard Isolation Test Method.

**Solder Materials**

The recommended solder profile for the FBAR duplexer is shown in Figure 20.

**Marking Code**

The marking code for the ACMD-7401 is as shown below:

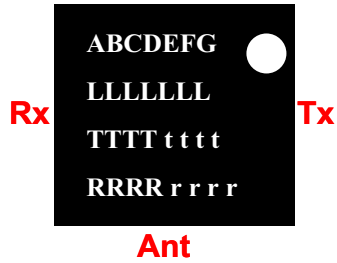

- A = Device Code  
(U = USPCS, G = GSM)
- B = Manufacturing location
- C = Year (3 = year 2003)
- DE = Workweek
- F = PCB Manufacturer
- G = PCB Revision
- LLLLLLL = Lot#
- TTTTtttt = TTTT Wafer lot #,  
          tttt wafer #
- RRRRrrrr = RRRR Wafer lot #,  
          rrrr wafer #

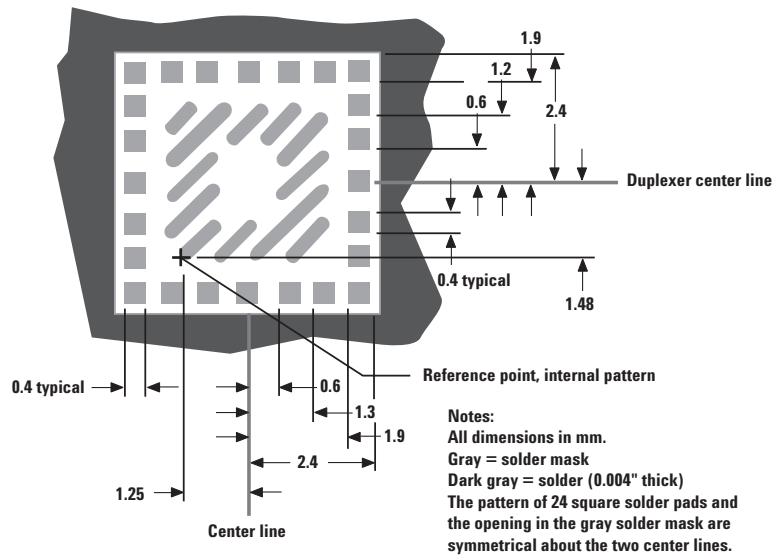

Figure 18. Solder Mask/Solder Stencil.



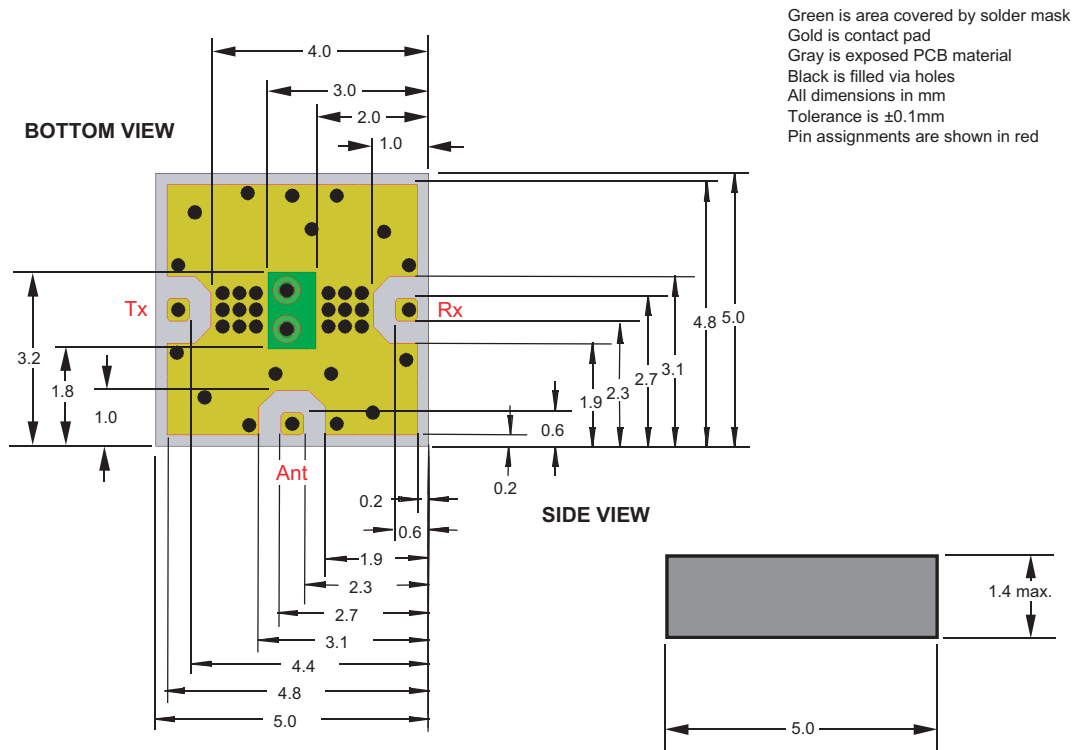

Figure 19. Outline drawing.

### Solder Compositions

Shaded line is the alloy type recommended by Agilent Technologies.

Alloy type	Melting temp. (°C)	Recommended working temperature (°C)
Sn42Bi58	138	160 – 180
Sn43Pb43Bi14	144 – 163	165 – 185
Sn63Pb37	183	200 – 240
Sn60Pb40	186	200 – 240
Sn91/Zn9	199	200 – 240
Sn96.2Ag2.5Cu0.8Sb0.5	216	235 – 255
Sn95.8Ag3.5Cu0.7	217	235 – 255
<b>Sn96.5Ag3.5</b>	<b>221</b>	<b>240 – 260</b>

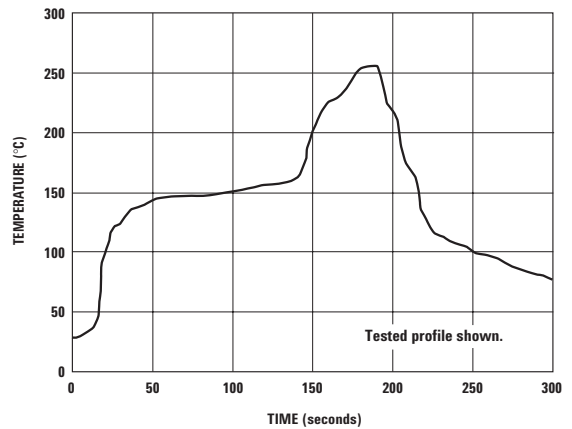

Figure 20. Recommended Solder Profile.

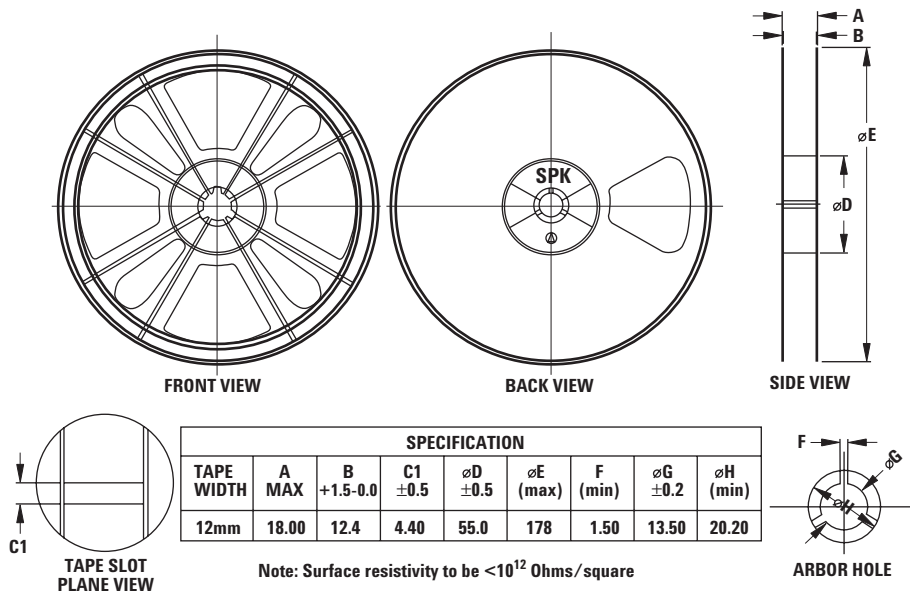

Figure 21. Reel Dimensions (all dimensions in mm).

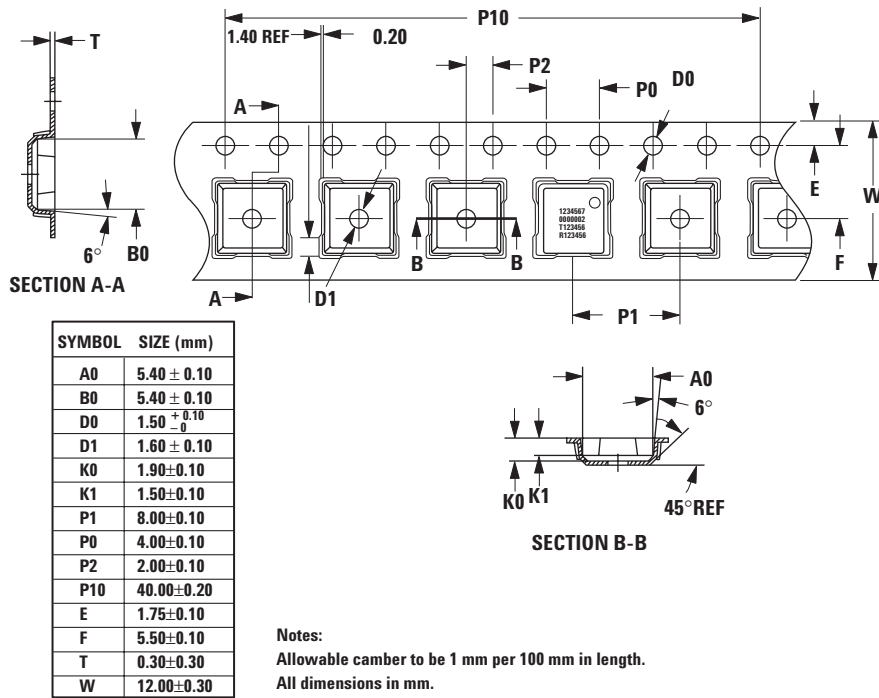

Figure 22. Tape Dimensions (all dimensions in mm).

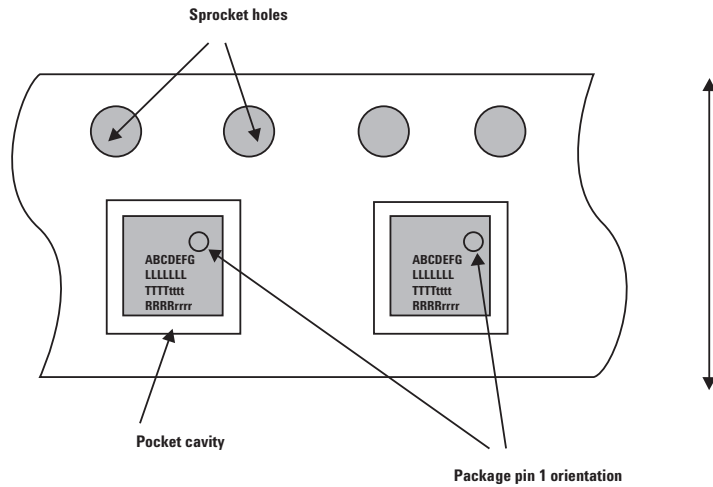

Figure 23. Unit Orientation in Tape.

### Ordering Information

Part Number	No. of Devices	Container
ACMD-7401-BLK	100	Anti-static bag
ACMD-7401-TR1	1000	7" Reel

### [www.agilent.com/semiconductors](http://www.agilent.com/semiconductors)

For product information and a complete list of distributors, please go to our web site.

For technical assistance call:

Americas/Canada: +1 (800) 235-0312 or  
(916) 788-6763

Europe: +49 (0) 6441 92460

China: 10800 650 0017

Hong Kong: (65) 6756 2394

India, Australia, New Zealand: (65) 6755 1939

Japan: (+81 3) 3335-8152(Domestic/International), or  
0120-61-1280(Domestic Only)

Korea: (65) 6755 1989

Singapore, Malaysia, Vietnam, Thailand, Philippines,  
Indonesia: (65) 6755 2044

Taiwan: (65) 6755 1843

Data subject to change.

Copyright © 2004 Agilent Technologies, Inc.

May 25, 2004

5989-0533EN



**Agilent Technologies**