

TOSHIBA FAST RECOVERY RECTIFIER SILICON DIFFUSED TYPE

1R5GH45

SWITCHING TYPE POWER SUPPLY APPLICATIONS

Unit in mm

- Repetitive Peak Reverse Voltage : $V_{RRM}=400V$
- Average Forward Current : $I_F(AV)=1.5A$
- Very Fast Reverse-Recovery Time : $t_{rr}=200ns$ (Max.)

MAXIMUM RATINGS

CHARACTERISTIC	SYMBOL	RATING	UNIT
Repetitive Peak Reverse Voltage	V_{RRM}	400	V
Average Forward Current ($T_a=25^{\circ}C$)	$I_F(AV)$	1.5	A
Peak One Cycle Surge Forward Current (Non-Repetitive)	I_{FSM}	50 (50Hz) 55 (60Hz)	A
Junction Temperature Range	T_j	-40~150	$^{\circ}C$
Storage Temperature Range	T_{stg}	-40~150	$^{\circ}C$

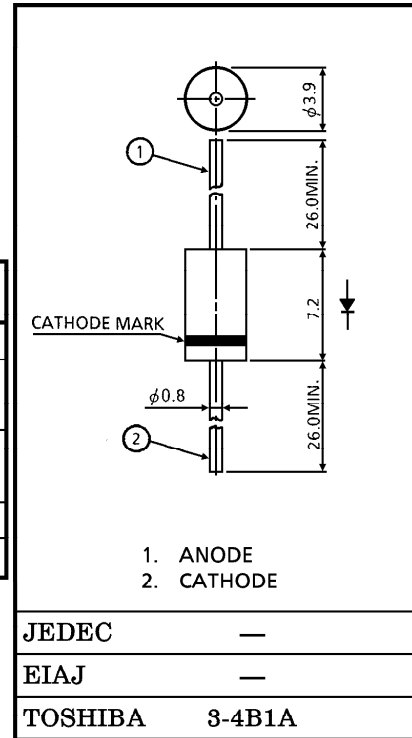

ELECTRICAL CHARACTERISTICS ($T_a=25^{\circ}C$)

Weight : 0.47g

CHARACTERISTIC	SYMBOL	TEST CONDITION	MIN.	TYP.	MAX.	UNIT
Peak Forward Voltage	V_{FM}	$I_{FM}=1.5A$	—	—	1.1	V
Repetitive Peak Reverse Current	I_{RRM}	$V_{RRM}=400V$	—	—	100	μA
Reverse Recovery Time	t_{rr}	$I_F=1A, di/dt=-30A/\mu s$	—	—	200	ns
Forward Recovery Time	t_{fr}	$I_F=1.0A$	—	—	400	ns
Thermal Resistance	$R_{th(j-a)}$	Junction to Ambient	—	—	58	$^{\circ}C/W$

MARKING

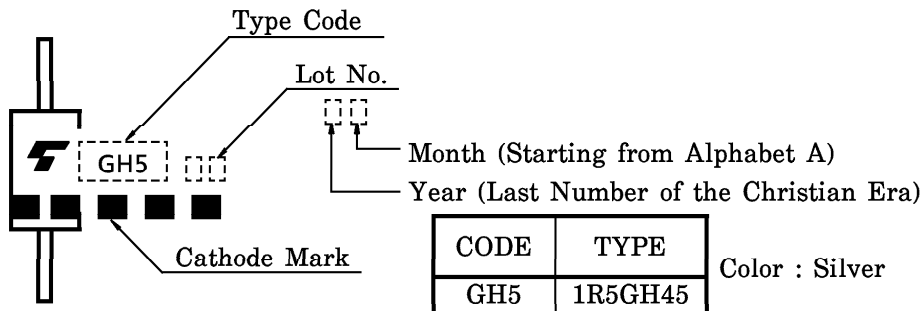

961001EAA2

● TOSHIBA is continually working to improve the quality and the reliability of its products. Nevertheless, semiconductor devices in general can malfunction or fail due to their inherent electrical sensitivity and vulnerability to physical stress. It is the responsibility of the buyer, when utilizing TOSHIBA products, to observe standards of safety, and to avoid situations in which a malfunction or failure of a TOSHIBA product could cause loss of human life, bodily injury or damage to property. In developing your designs, please ensure that TOSHIBA products are used within specified operating ranges as set forth in the most recent products specifications. Also, please keep in mind the precautions and conditions set forth in the TOSHIBA Semiconductor Reliability Handbook.

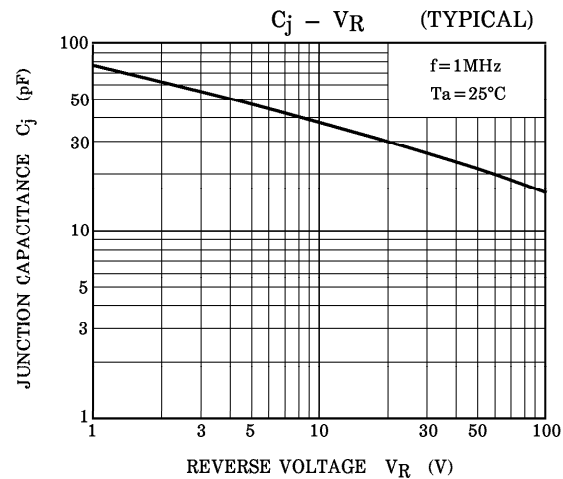
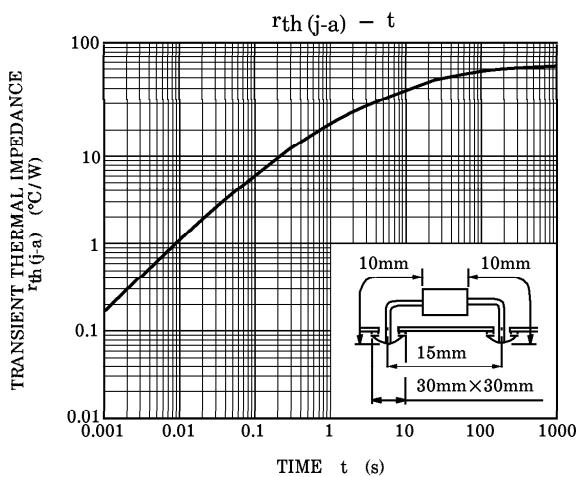
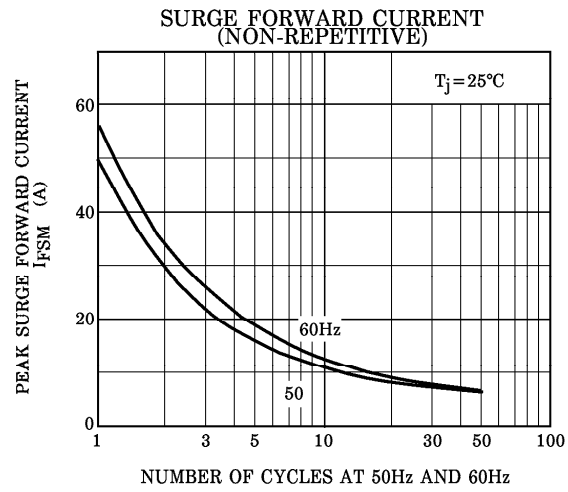
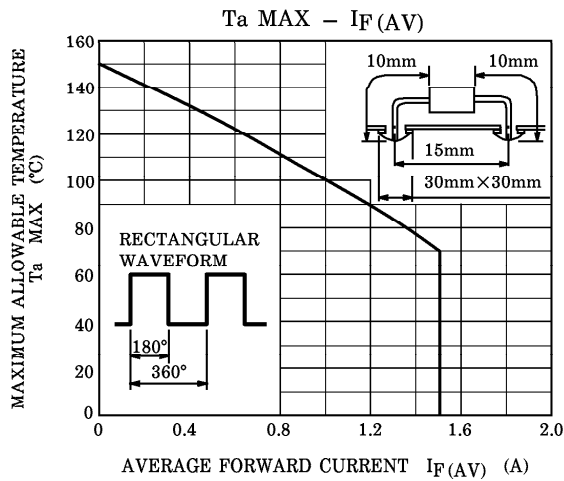
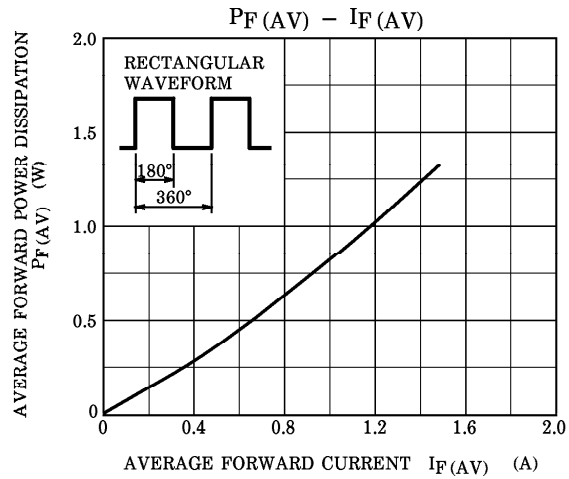
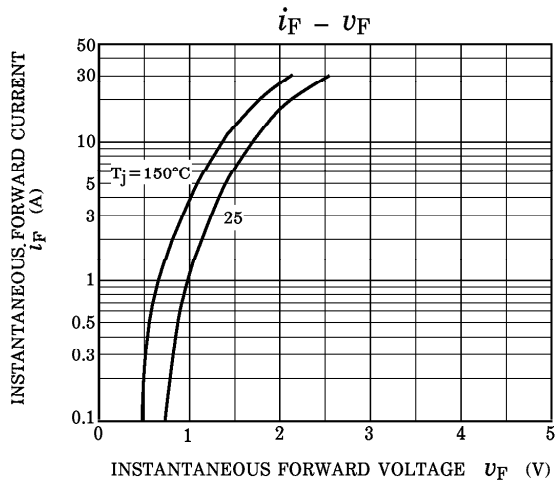

961001EAA2'

- The information contained herein is presented only as a guide for the applications of our products. No responsibility is assumed by TOSHIBA CORPORATION for any infringements of intellectual property or other rights of the third parties which may result from its use. No license is granted by implication or otherwise under any intellectual property or other rights of TOSHIBA CORPORATION or others.
- The information contained herein is subject to change without notice.