

CEP06N5/CEB06N5

Oct. 2002

N-Channel Logic Level Enhancement Mode Field Effect Transistor

4

FEATURES

- 500V , 6.6A , $R_{DS(ON)}=1\Omega$ @ $V_{GS}=10V$.
- Super high dense cell design for extremely low $R_{DS(ON)}$.
- High power and current handling capability.
- TO-220 & TO-263 package.

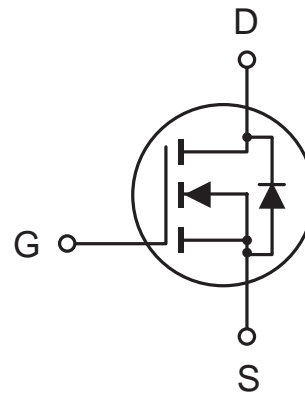

ABSOLUTE MAXIMUM RATINGS (Tc=25°C unless otherwise noted)

Parameter	Symbol	Limit	Unit
Drain-Source Voltage	V _{DS}	500	V
Gate-Source Voltage	V _{GS}	± 30	V
Drain Current-Continuous -Pulsed	I _D	6.6	A
	I _{DM}	20	A
Drain-Source Diode Forward Current	I _S	6.6	A
Maximum Power Dissipation @Tc=25°C Derate above 25°C	P _D	104	W
		0.83	W/°C
Operating and Storage Temperature Range	T _J , T _{STG}	-55 to 150	°C

THERMAL CHARACTERISTICS

Thermal Resistance, Junction-to-Case	R _{θJC}	1.2	°C/W
Thermal Resistance, Junction-to-Ambient	R _{θJA}	62.5	°C/W

CEP06N5/CEB06N5

4

ELECTRICAL CHARACTERISTICS (Tc=25°C unless otherwise noted)

Parameter	Symbol	Condition	Min	Typ	Max	Unit
DRAIN-SOURCE AVALANCHE RATING^a						
Single Pulse Drain-Source Avalanche Energy	E _{AS}	V _{DD} =50V, L=24mH R _G =25Ω		500		mJ
Maximum Drain-Source Avalanche Current	I _{AS}			6		A
OFF CHARACTERISTICS						
Drain-Source Breakdown Voltage	BV _{DSS}	V _{GS} = 0V, I _D = 250μA	500			V
Zero Gate Voltage Drain Current	I _{DSS}	V _{DS} = 500V, V _{GS} = 0V			25	μA
Gate-Body Leakage	I _{GSS}	V _{GS} = ±30V, V _{DS} = 0V			±100	nA
ON CHARACTERISTICS^a						
Gate Threshold Voltage	V _{GS(th)}	V _{DS} = V _{GS} , I _D = 250μA	2		4	V
Drain-Source On-State Resistance	R _{DS(ON)}	V _{GS} = 10V, I _D = 4A		0.85	1.0	Ω
On-State Drain Current	I _{D(ON)}	V _{GS} = 10V, V _{DS} = 10V	6			A
Forward Transconductance	g _{FS}	V _{DS} = 50V, I _D = 4A		4		S
SWITCHING CHARACTERISTICS^b						
Turn-On Delay Time	t _{D(ON)}	V _{DD} = 250V, I _D = 6A, V _{GS} = 10V R _{GEN} = 18Ω		23	45	ns
Rise Time	t _r			35	70	ns
Turn-Off Delay Time	t _{D(OFF)}			162	240	ns
Fall Time	t _f			44	90	ns
Total Gate Charge	Q _g	V _{DS} = 400V, I _D = 6A, V _{GS} = 10V		54	65	nC
Gate-Source Charge	Q _{gs}			9		nC
Gate-Drain Charge	Q _{gd}			27		nC

CEP06N5/CEB06N5

ELECTRICAL CHARACTERISTICS ($T_c=25^\circ\text{C}$ unless otherwise noted)

4

Parameter	Symbol	Condition	Min	Typ	Max	Unit
DYNAMIC CHARACTERISTICS^b						
Input Capacitance	C_{ISS}	$V_{DS}=25\text{V}, V_{GS}=0\text{V}$ $f=1.0\text{MHz}$		823		pF
Output Capacitance	C_{OSS}			110		pF
Reverse Transfer Capacitance	C_{RSS}			64		pF
DRAIN-SOURCE DIODE CHARACTERISTICS^a						
Diode Forward Voltage	V_{SD}	$V_{GS}=0\text{V}, I_S=6\text{A}$			1.5	V

Notes

a. Pulse Test: Pulse Width $\leq 300 \mu\text{s}$, Duty Cycle $\leq 2\%$.

b. Guaranteed by design, not subject to production testing.

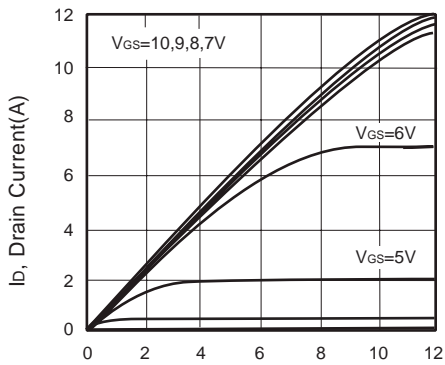

Figure 1. Output Characteristics

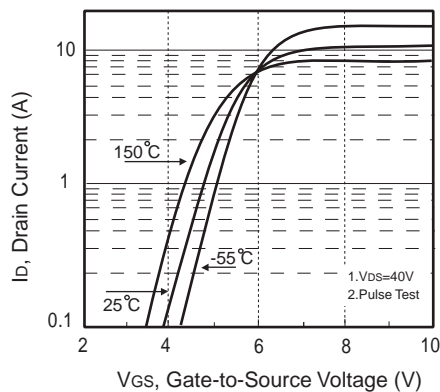

Figure 2. Transfer Characteristics

CEP06N5/CEB06N5

4

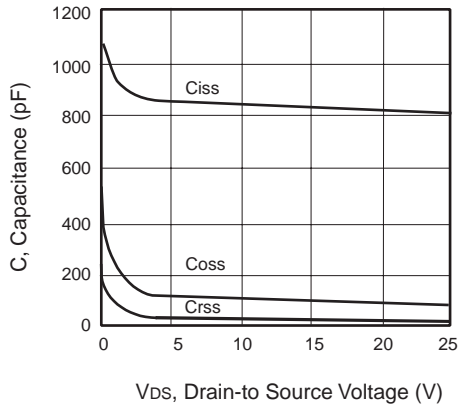

Figure 3. Capacitance

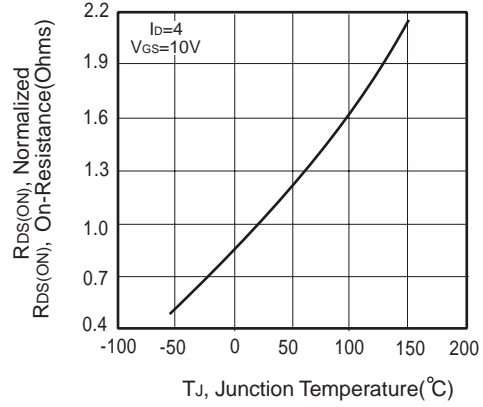

Figure 4. On-Resistance Variation with Temperature

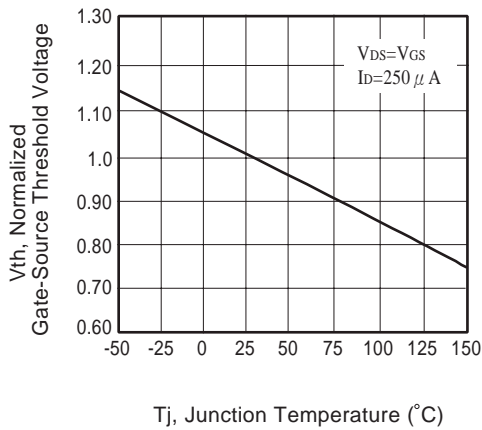

Figure 5. Gate Threshold Variation with Temperature

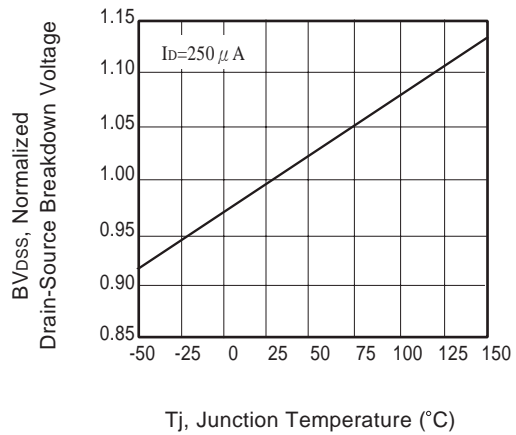

Figure 6. Breakdown Voltage Variation with Temperature

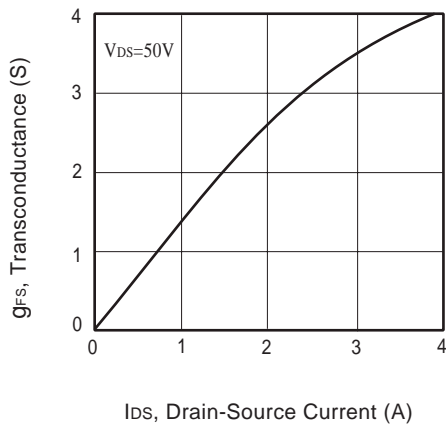

Figure 7. Transconductance Variation with Drain Current

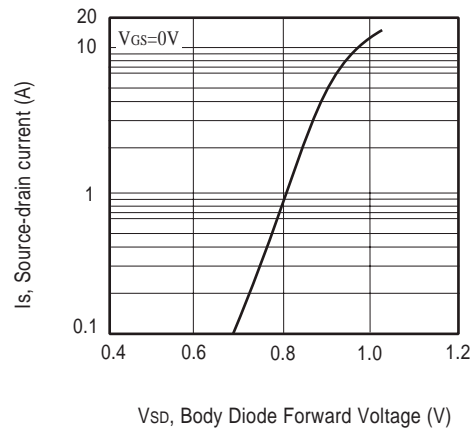

Figure 8. Body Diode Forward Voltage Variation with Source Current

CEP06N5/CEB06N5

4

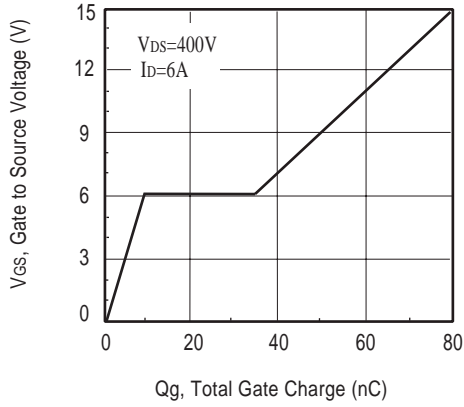

Figure 9. Gate Charge

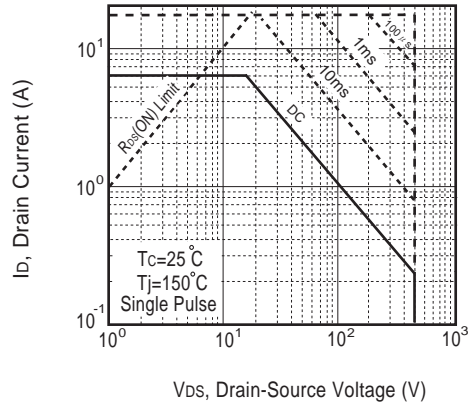

Figure 10. Maximum Safe Operating Area

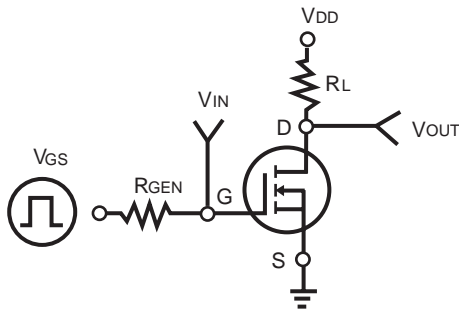

Figure 11. Switching Test Circuit

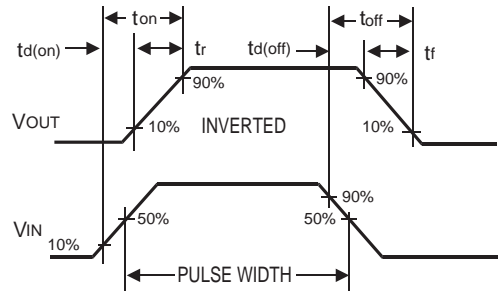

Figure 12. Switching Waveforms

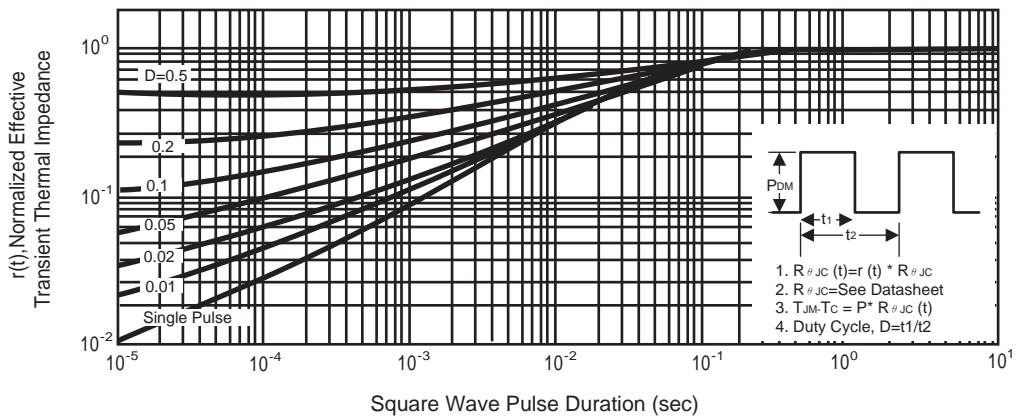

Figure 13. Normalized Thermal Transient Impedance Curve