

## High –speed double diode

# BAV70N3

### Description

The BAV70N3 consists of two high-speed switching diodes with common cathodes, fabricated in planar technology, and encapsulated in the small SOT-23 plastic SMD package.

### Equivalent Circuit

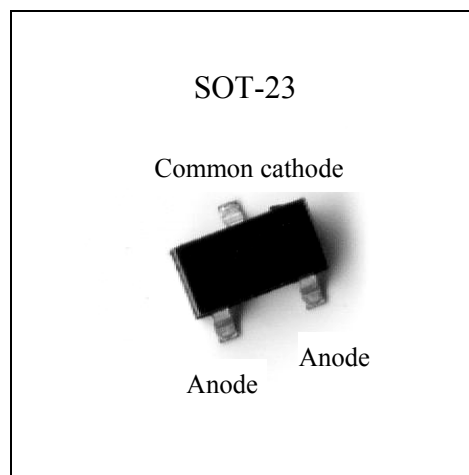
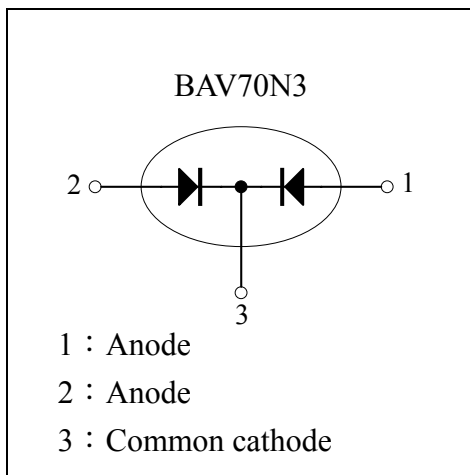

### Features

- Small plastic SMD package
- High switching speed: max. 4ns
- Continuous reverse voltage: max. 75V
- Repetitive peak reverse voltage: max. 85V
- Repetitive peak forward current: max. 450mA.

### Applications

- High-speed switching in thick and thin-film circuits.



**Absolute Maximum Ratings @TA=25°C**

Parameters	Symbol	Min	Max	Unit
Repetitive peak reverse voltage	$V_{RRM}$	-	85	V
Continuous reverse voltage	$V_R$	-	75	V
Continuous forward current(single diode loaded)	$I_F$	-	215	mA
Continuous forward current(double diode loaded)		-	125	
Repetitive peak forward current	$I_{FRM}$		450	mA
Non-repetitive peak forward current @square wave, $T_j=125^\circ\text{C}$ prior to surge	$I_{FSM}$	$t=1\mu\text{s}$	4	A
		$t=1\text{ms}$	1	A
		$t=1\text{s}$	0.5	A
Total power dissipation(Note 1)	$P_{tot}$		250	mW
Junction Temperature	$T_j$	-	150	°C
Storage Temperature	$T_{stg}$	-65	+150	°C

Note 1: Device mounted on an FR-4 PCB.

**Electrical Characteristics @ Tj=25°C unless otherwise specified**

Parameters	Symbol	Conditions	Min	Typ.	Max	Unit
Forward voltage	$V_F$	$I_F=1\text{mA}$	-	-	715	mV
		$I_F=10\text{mA}$	-	-	855	mV
		$I_F=50\text{mA}$	-	-	1	V
		$I_F=150\text{mA}$	-	-	1.25	V
Reverse current	$I_R$	$V_R=25\text{V}$	-	-	30	nA
		$V_R=75\text{V}$	-	-	2.5	$\mu\text{A}$
		$V_R=25\text{V}, T_j=150^\circ\text{C}$	-	-	60	$\mu\text{A}$
		$V_R=75\text{V}, T_j=150^\circ\text{C}$	-	-	100	$\mu\text{A}$
Diode capacitance	$C_d$	$V_R=0\text{V}, f=1\text{MHz}$	-	-	1.5	pF
Reverse recovery time	$t_{rr}$	when switched from $I_F=10\text{mA}$ to $I_R=10\text{mA}, R_L=100\Omega$ , measured at $I_R=1\text{mA}$	-	-	4	ns
Forward recovery voltage	$V_{fr}$	when switched from $I_F=10\text{mA}$ to $I_R=10\text{mA}$ at $t_r=20\text{ns}$	-	-	1.75	V

**Thermal Characteristics**

Symbol	Parameter	Conditions	Value	Unit
$R_{th,j-tp}$	thermal resistance from junction to tie-point		360	°C/W
$R_{th,j-a}$	thermal resistance from junction to ambient	Note 1	500	°C/W

Note 1: Device mounted on an FR-4 PCB.



### Characteristic Curves

Forward Current vs Ambient Temperature

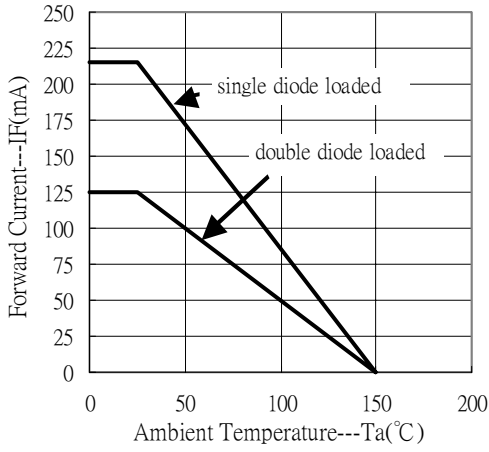

Forward Current vs Forward Voltage

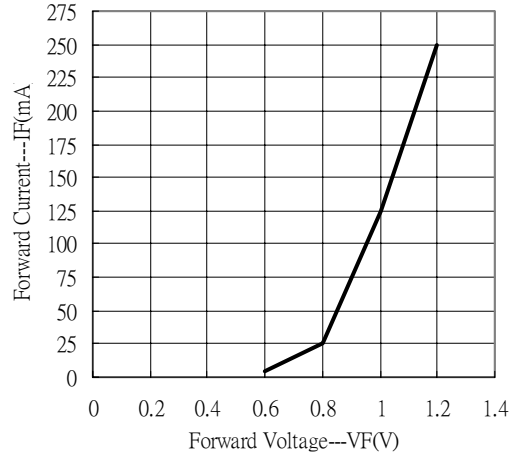

Non-repetitive peak forward current vs pulse duration

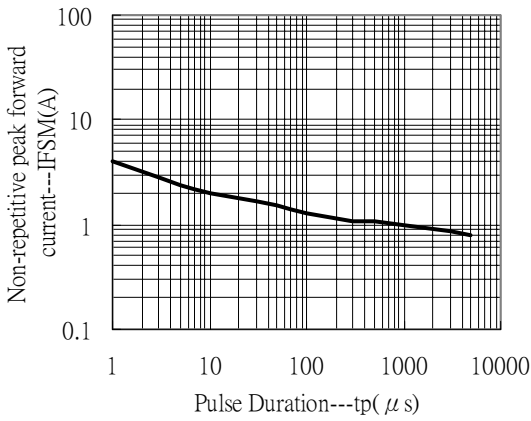

Diode Capacitance vs Reverse Voltage

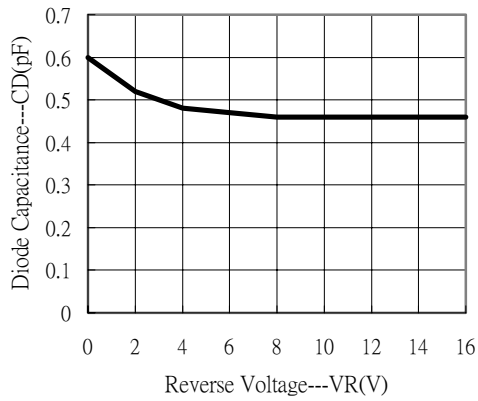

**SOT-23 Dimension**

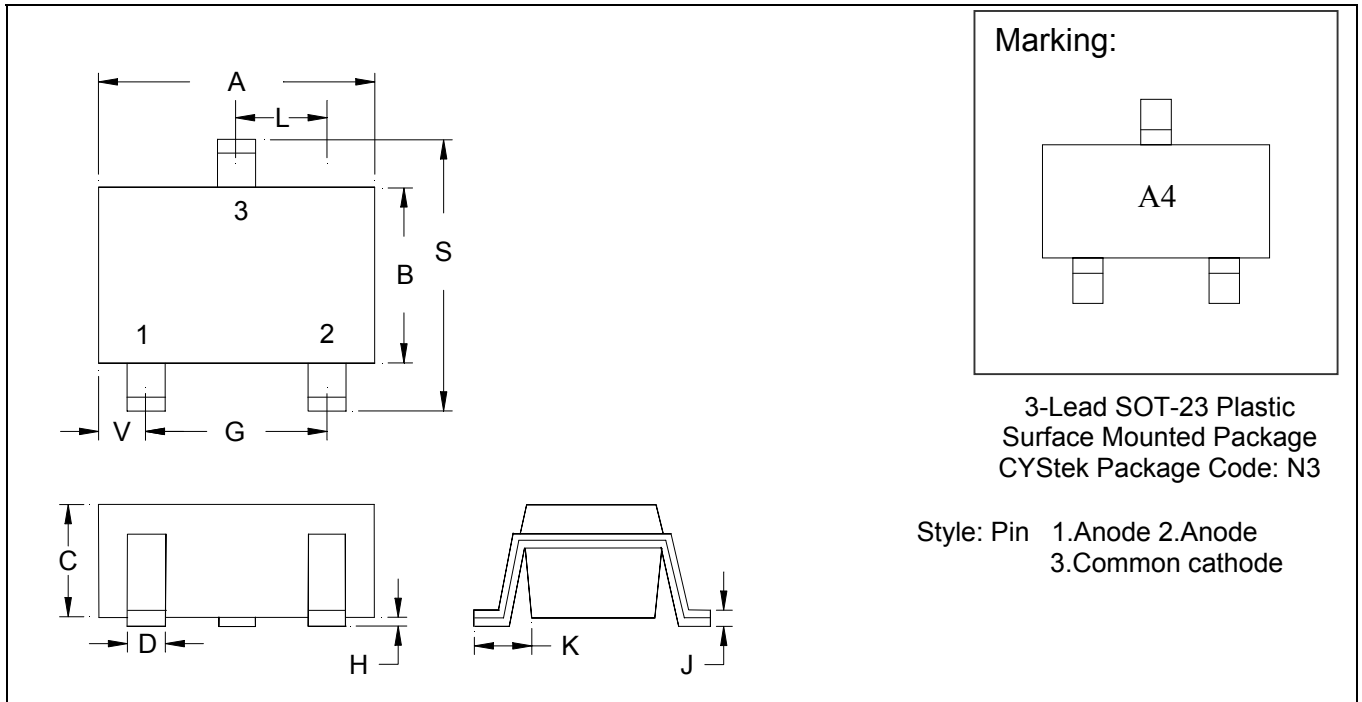

\*: Typical

DIM	Inches		Millimeters		DIM	Inches		Millimeters	
	Min.	Max.	Min.	Max.		Min.	Max.	Min.	Max.
A	0.1102	0.1204	2.80	3.04	J	0.0034	0.0070	0.085	0.177
B	0.0472	0.0630	1.20	1.60	K	0.0128	0.0266	0.32	0.67
C	0.0335	0.0512	0.89	1.30	L	0.0335	0.0453	0.85	1.15
D	0.0118	0.0197	0.30	0.50	S	0.0830	0.1083	2.10	2.75
G	0.0669	0.0910	1.70	2.30	V	0.0098	0.0256	0.25	0.65
H	0.0005	0.0040	0.013	0.10					

Notes: 1.Controlling dimension: millimeters.  
 2.Maximum lead thickness includes lead finish thickness, and minimum lead thickness is the minimum thickness of base material.  
 3.If there is any question with packing specification or packing method, please contact your local CYStek sales office.

**Material:**

- Lead: 42 Alloy ; solder plating
- Mold Compound: Epoxy resin family, flammability solid burning class: UL94V-0

**Important Notice:**

- All rights are reserved. Reproduction in whole or in part is prohibited without the prior written approval of CYStek.
- CYStek reserves the right to make changes to its products without notice.
- CYStek **semiconductor products are not warranted to be suitable for use in Life-Support Applications, or systems.**
- CYStek assumes no liability for any consequence of customer product design, infringement of patents, or application assistance.