



DC COMPONENTS CO., LTD.

RECTIFIER SPECIALISTS

**SF31
THRU
SF38**

TECHNICAL SPECIFICATIONS OF SUPER FAST RECTIFIER

VOLTAGE RANGE - 50 to 600 Volts

CURRENT - 3.0 Amperes

FEATURES

- * High reliability
- * Low leakage
- * Low forward voltage
- * High current capability
- * Super fast switching speed
- * High surge capability
- * Good for switching mode circuit

MECHANICAL DATA

- * Case: Molded plastic
- * Epoxy: UL 94V-0 rate flame retardant
- * Lead: MIL-STD-202E, Method 208 guaranteed
- * Mounting position: Any
- * Weight: 1.18 grams

MAXIMUM RATINGS AND ELECTRICAL CHARACTERISTICS

Ratings at 25 °C ambient temperature unless otherwise specified.
Single phase, half wave, 60 Hz, resistive or inductive load.
For capacitive load, derate current by 20%.



DO-27

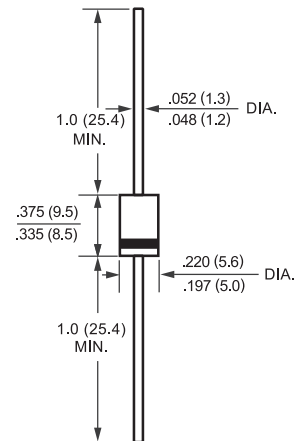

Dimensions in inches and (millimeters)

	SYMBOL	SF31	SF32	SF33	SF34	SF35	SF36	SF38	UNITS	
Maximum Recurrent Peak Reverse Voltage	V _{RRM}	50	100	150	200	300	400	600	Volts	
Maximum RMS Volts	V _{RMS}	35	70	105	140	210	280	420	Volts	
Maximum DC Blocking Voltage	V _{DC}	50	100	150	200	300	400	600	Volts	
Maximum Average Forward Current at T _A = 55°C	I _O	3.0							Amps	
Peak Forward Surge Current I _{FM} (surge):8.3 ms single half sine-wave superimposed on rated load (JEDEC Method)	I _{FSM}	125							Amps	
Maximum Forward Voltage at 3.0A DC	V _F	0.95			1.25		1.7		Volts	
Maximum DC Reverse Current	I _R	@ T _A = 25°C							uAmps	
at Rated DC Blocking Voltage		@ T _A = 150°C								
Maximum Reverse Recovery Time (Note 1)	t _{rr}	35							nSec	
Typical Junction Capacitance (Note 2)	C _J	50				30				pF
Operating and Storage Temperature Range	T _J , T _{STG}	-65 to + 150							°C	

NOTES : 1. Test Conditions: I_F=0.5A, I_R=1.0A, I_{RR}=0.25A.
2. Measured at 1 MHz and applied reverse voltage of 4.0 volts.

RATING AND CHARACTERISTIC CURVES (SF31 THRU SF38)

FIG. 1 - TEST CIRCUIT DIAGRAM AND REVERSE RECOVERY TIME CHARACTERISTIC

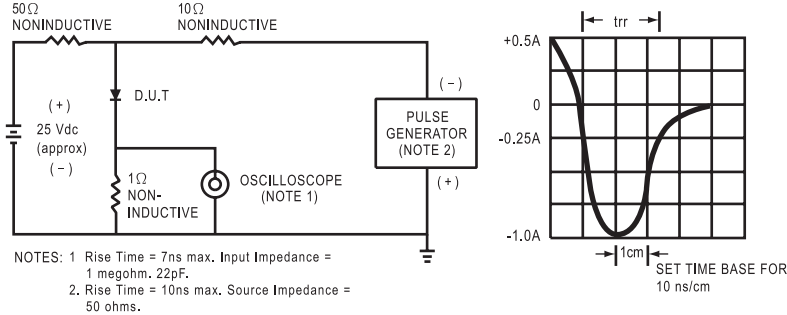

FIG. 2 - TYPICAL FORWARD CURRENT DERATING CURVE

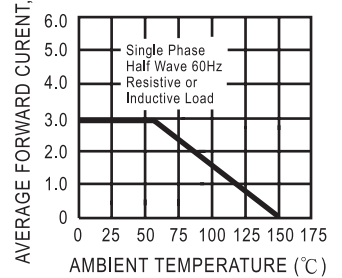

FIG. 3 - TYPICAL REVERSE CHARACTERISTICS

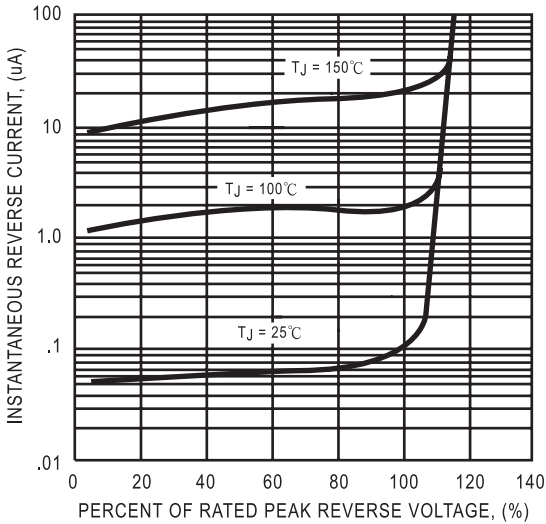

FIG. 4 - TYPICAL INSTANTANEOUS FORWARD CHARACTERISTICS

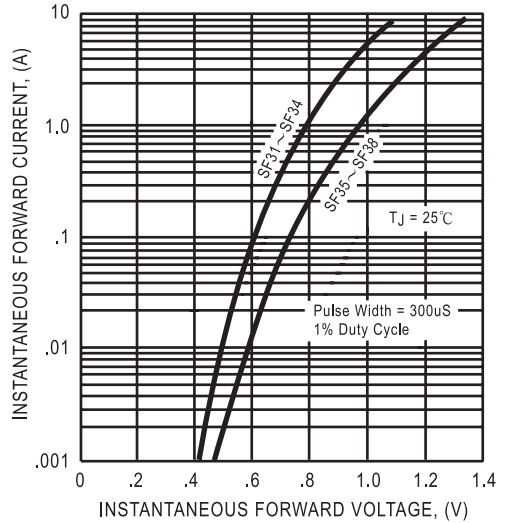

FIG. 5 - MAXIMUM NON-REPETITIVE FORWARD SURGE CURRENT

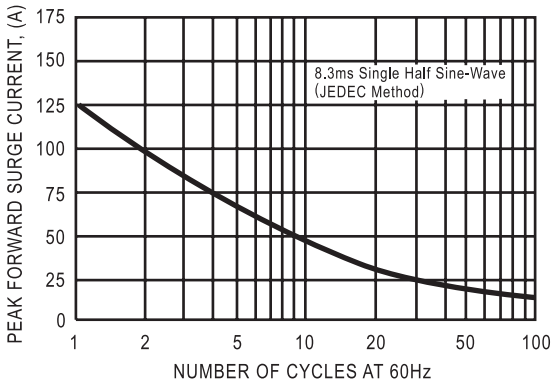
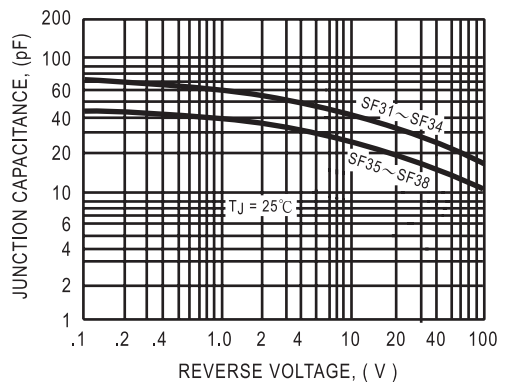

FIG. 6 - TYPICAL JUNCTION CAPACITANCE



DC COMPONENTS CO., LTD.