HA13155

33 W × 4-Channel BTL Power IC

HITACHI

ADE-207-187A (Z)
2nd Edition
Jul. 1999

Description

The HA13155 is four-channel BTL amplifier IC designed for car audio, featuring high output and low distortion, and applicable to digital audio equipment. It provides 33 W output per channel, with a 13.7 V power supply and at Max distortion.

Functions

- 4 ch BTL power amplifiers
- Built-in standby circuit
- Built-in muting circuit
- Built-in protection circuit (surge, T.S.D, and ASO)

Features

- Requires few external parts
- Popping noise minimized
- Low output noise
- Built-in high reliability protection circuit
- Pin to pin with HA13150A/HA13151/HA13152/HA13153

Block Diagram

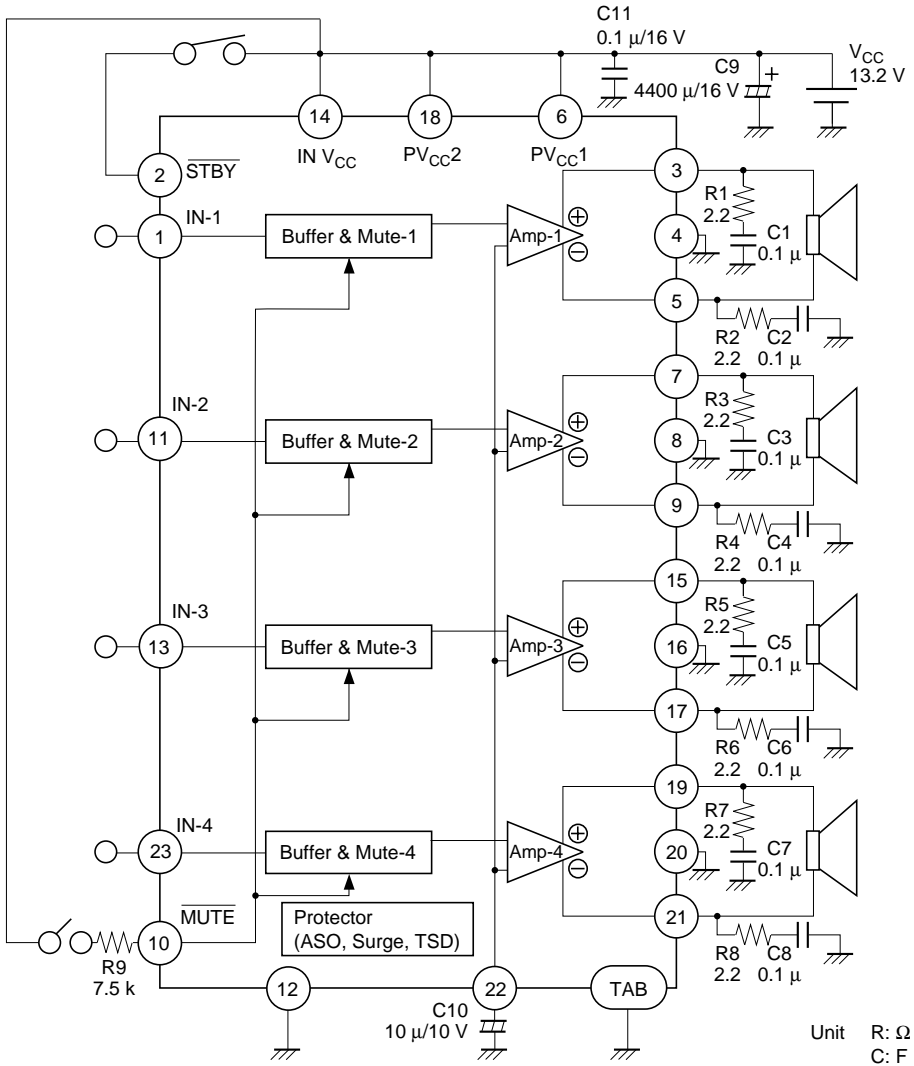

C1 to C8 should be polyester film capacitors with no secondary resonance (non-inductive), to assure stable operation.

- Notes:
1. Standby
Power is turned on when a signal of 3.5 V or 0.05 mA is impressed at pin 2. When pin 2 is open or connected to GND, standby is turned on (output off).
 2. Muting
Muting is turned off (output on) when a signal of 3.5 V or 0.2 mA is impressed at pin 10. When pin 10 is open or connected to GND, muting is turned on (output off).
 3. TAB (header of IC) connected to GND.

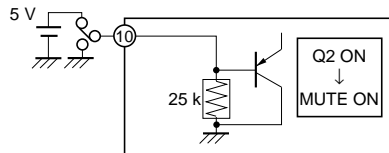
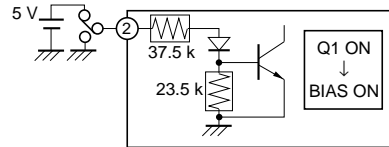

Absolute Maximum Ratings

Item	Symbol	Rating	Unit
Operating supply voltage	V_{CC}	18	V
Supply voltage when no signal* ¹	V_{CC} (DC)	26	V
Peak supply voltage* ²	V_{CC} (PEAK)	50	V
Output current* ³	I_o (PEAK)	4	A
Power dissipation* ⁴	P_T	83	W
Junction temperature	T_j	150	°C
Operating temperature	T_{opr}	-30 to +85	°C
Storage temperature	T_{stg}	-55 to +125	°C

- Notes: 1. Tolerance within 30 seconds.
 2. Tolerance in surge pulse waveform.
 3. Value per 1 channel.
 4. Value when attached on the infinite heat sink plate at $T_a = 25^\circ\text{C}$.
 The derating curve is as shown in the graph below.

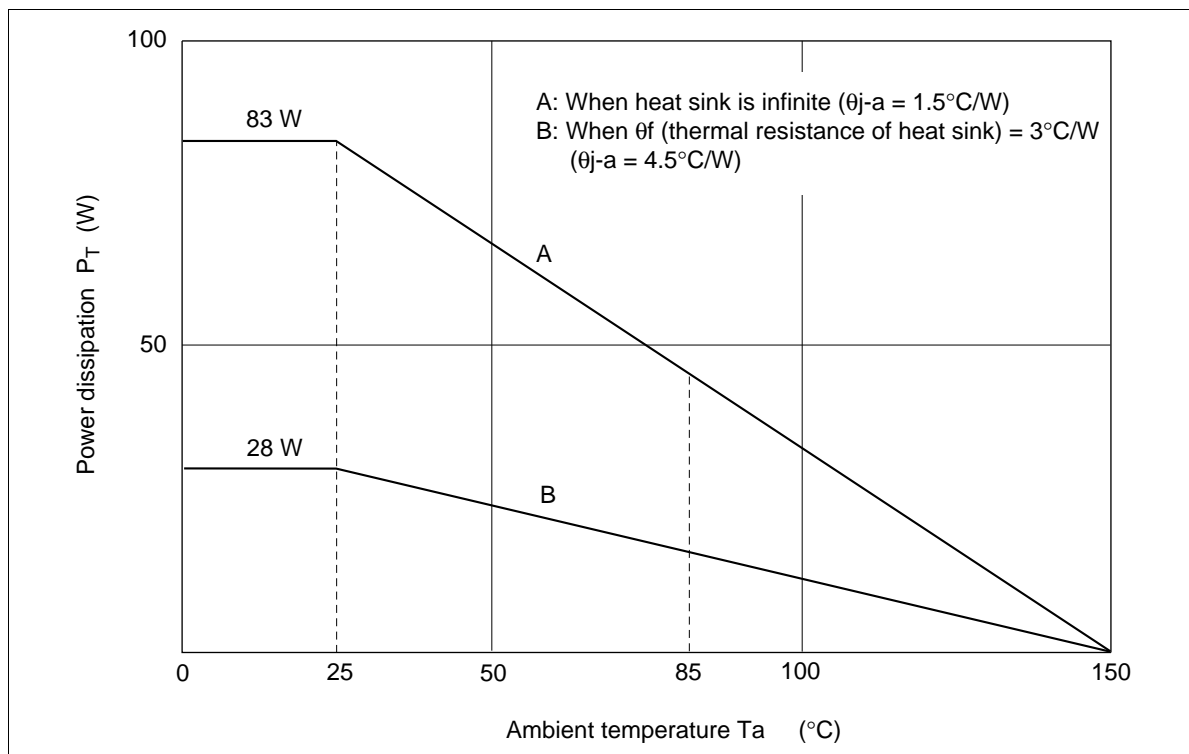

Electrical Characteristics ($V_{CC} = 13.2\text{ V}$, $f = 1\text{ kHz}$, $R_L = 4\ \Omega$, $R_g = 600\ \Omega$, $T_a = 25^\circ\text{C}$)

Item	Symbol	Min	Typ	Max	Unit	Test Conditions
Quiescent current	I_{Q1}	—	300	—	mA	$V_{in} = 0$
Output offset voltage	ΔV_Q	-250	0	+250	mV	
Gain	G_V	30.5	32	33.5	dB	
Gain difference between channels	ΔG_V	-1.0	0	+1.0	dB	
Rated output power	P_o	—	19	—	W	$V_{CC} = 13.2\text{ V}$ THD = 10%, $R_L = 4\ \Omega$
Max output power	$P_{o\max}$	—	33	—	W	$V_{CC} = 13.7\text{ V}$, $R_L = 4\ \Omega$
Total harmonic distortion	T.H.D.	—	0.02	—	%	$P_o = 3\text{ W}$
Output noise voltage	WBN	—	0.15	—	mVrms	$R_g = 0\ \Omega$ BW = 20 to 20 kHz
Ripple rejection	SVR	—	55	—	dB	$R_g = 600\ \Omega$, $f = 120\text{ Hz}$
Channel cross talk	C.T.	—	70	—	dB	$R_g = 600\ \Omega$ $V_{out} = 0\text{ dBm}$
Input impedance	R_{in}	—	25	—	k Ω	
Standby current	I_{Q2}	—	—	10	μA	
Standby control voltage (high)	V_{STH}	3.5	—	V_{CC}	V	
Standby control voltage (low)	V_{STL}	0	—	1.5	V	
Muting control voltage (high)	V_{MH}	3.5	—	V_{CC}	V	
Muting control voltage (low)	V_{ML}	0	—	1.5	V	
Muting attenuation	ATTM	—	70	—	dB	$V_{out} = 0\text{ dBm}$

Characteristics Curve

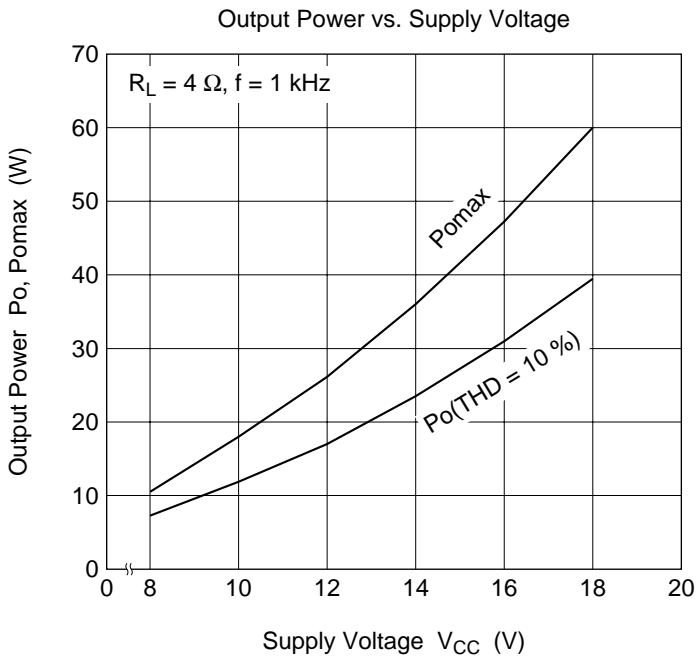
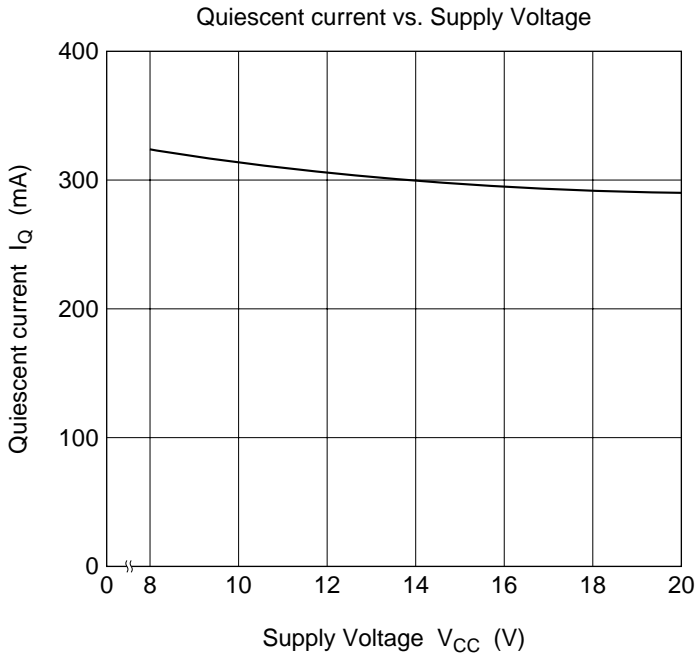

Total Harmonic Distortion vs. Frequency

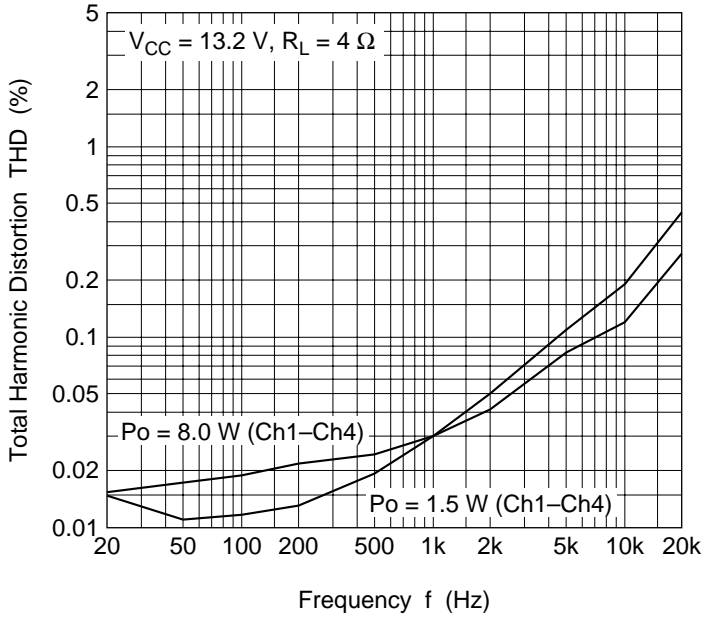

Total Harmonic Distortion vs. Output Power

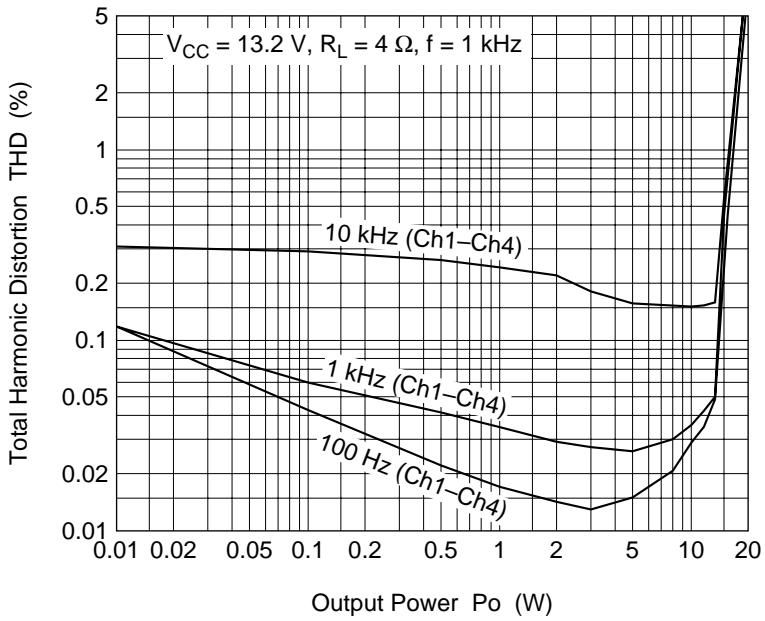

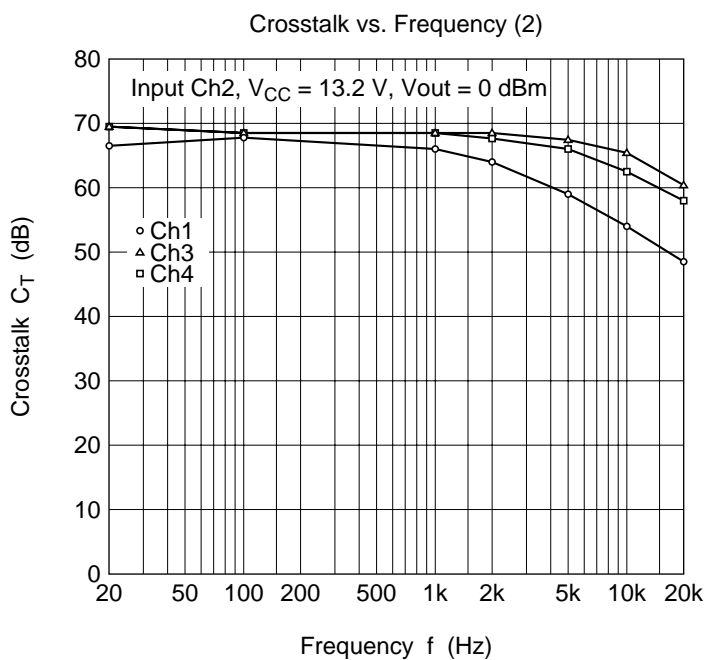
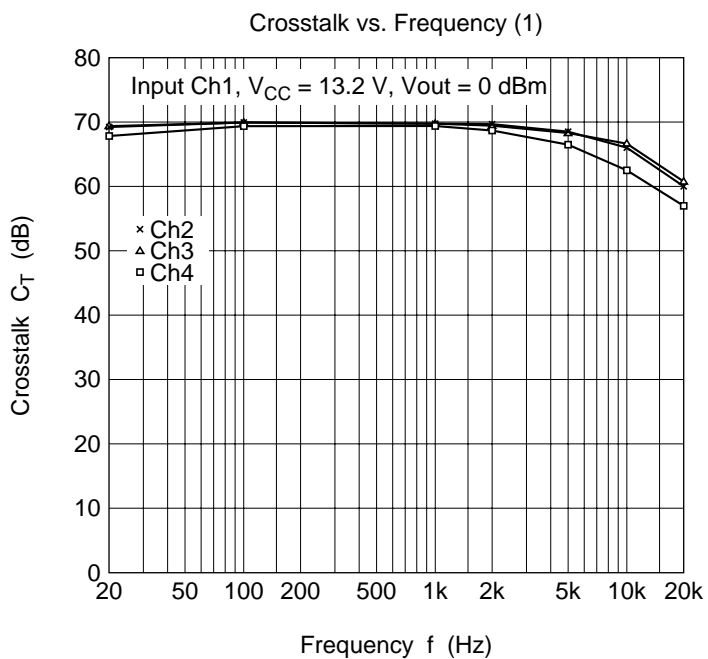

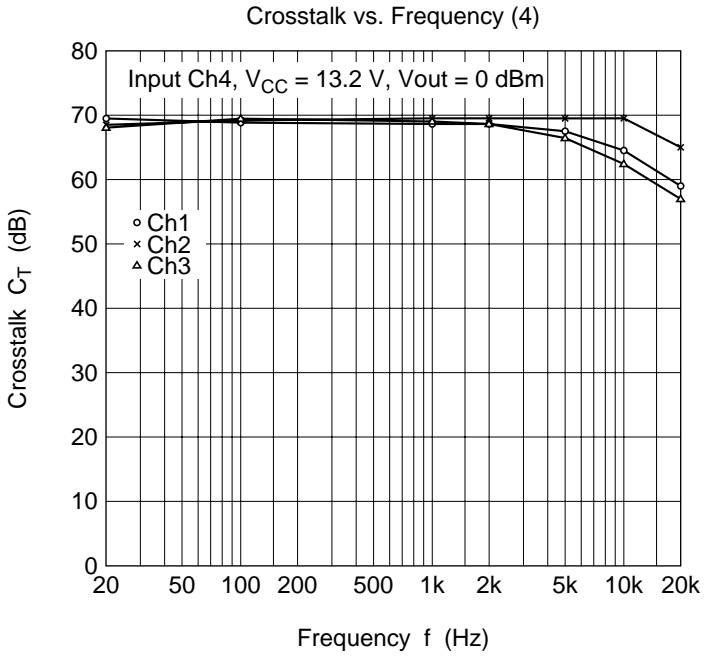
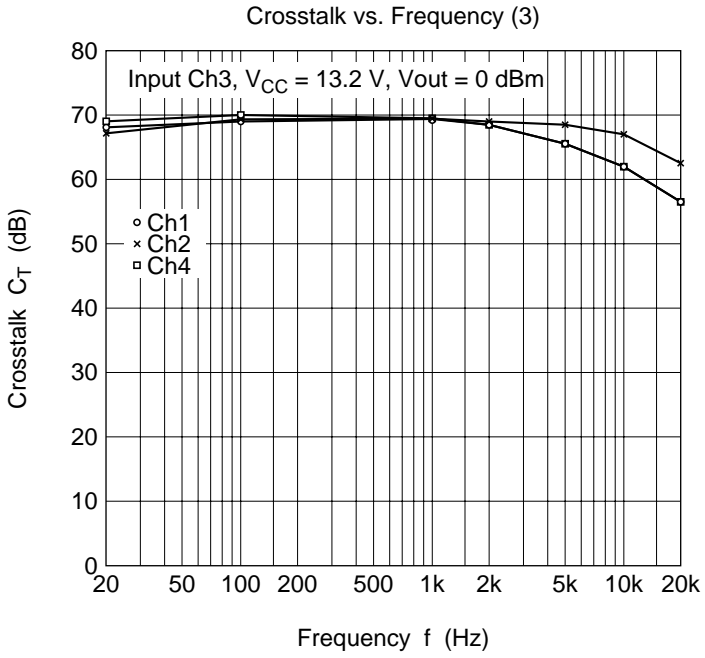

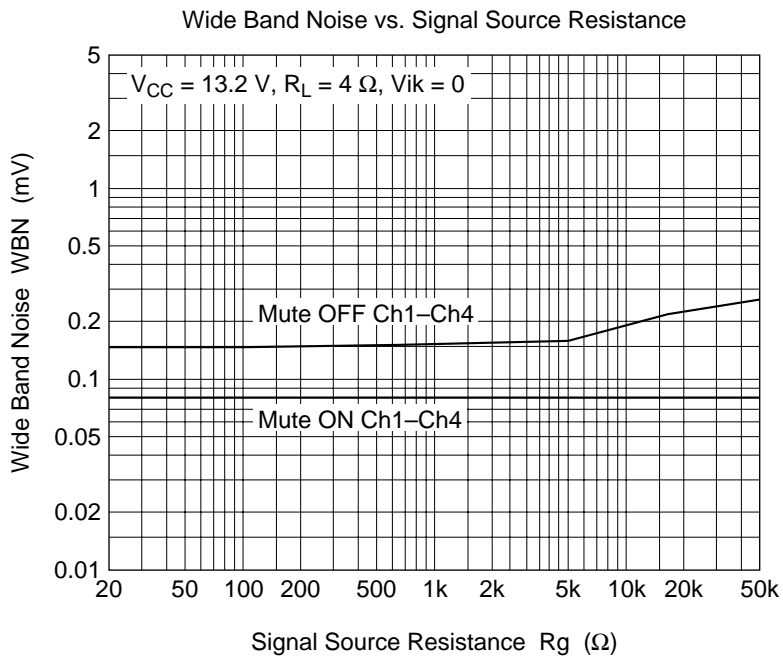
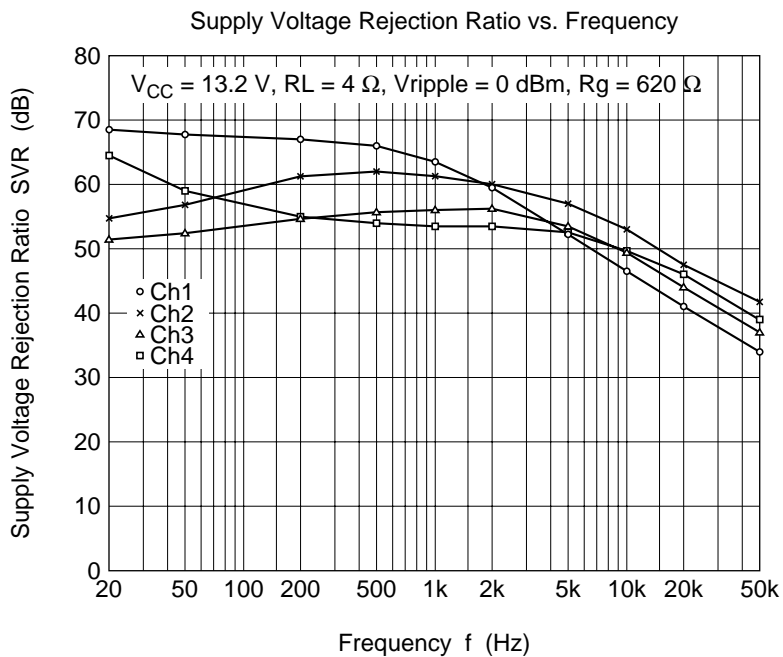

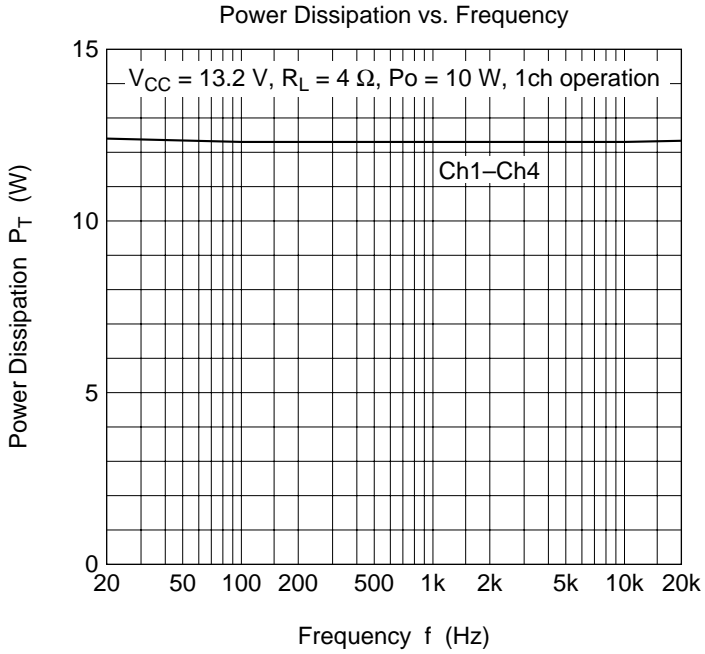
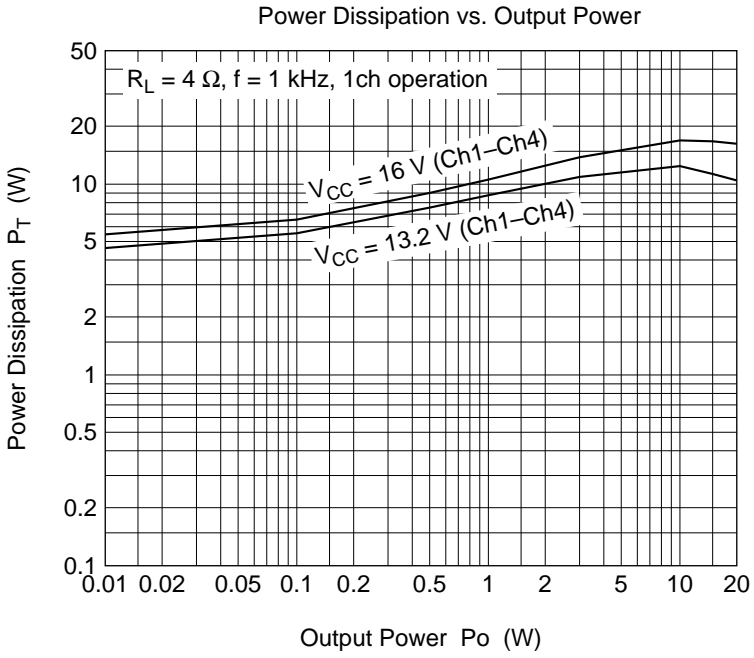

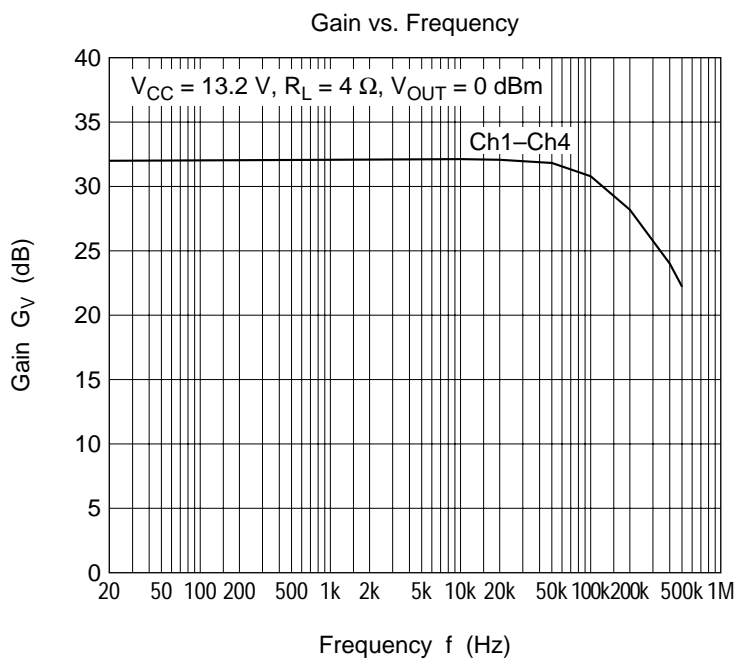

Package Dimensions

Unit: mm

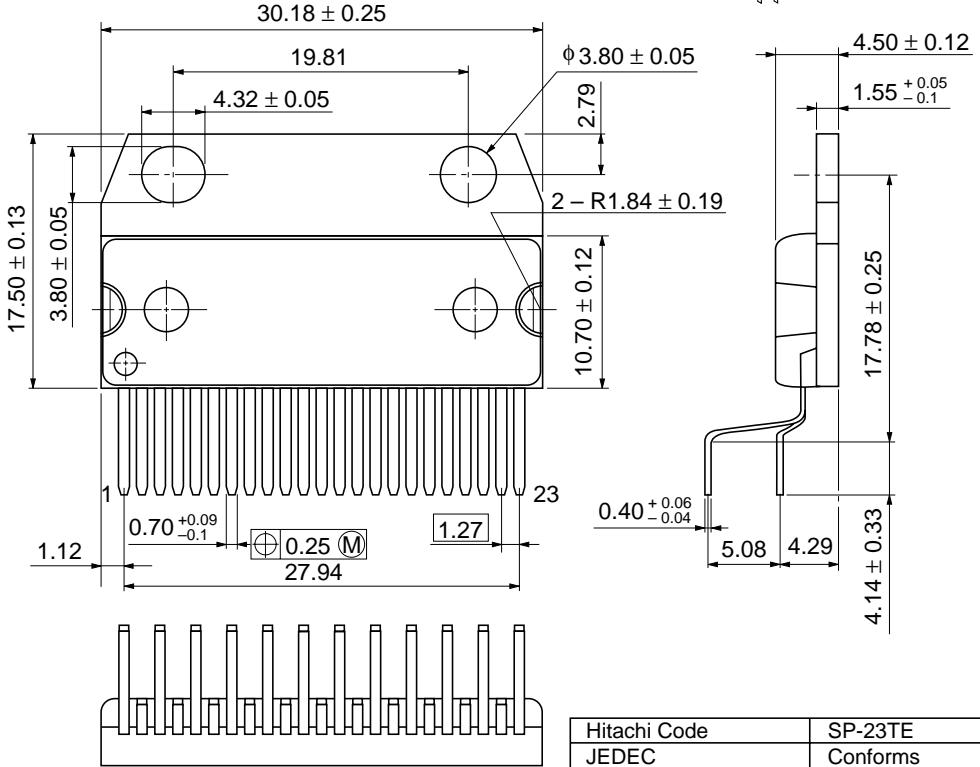
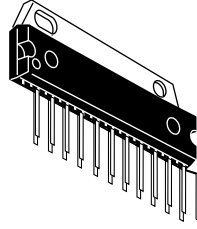

Hitachi Code	SP-23TE
JEDEC	Conforms
EIAJ	—
Weight (reference value)	8.5 g

Cautions

1. Hitachi neither warrants nor grants licenses of any rights of Hitachi's or any third party's patent, copyright, trademark, or other intellectual property rights for information contained in this document. Hitachi bears no responsibility for problems that may arise with third party's rights, including intellectual property rights, in connection with use of the information contained in this document.
2. Products and product specifications may be subject to change without notice. Confirm that you have received the latest product standards or specifications before final design, purchase or use.
3. Hitachi makes every attempt to ensure that its products are of high quality and reliability. However, contact Hitachi's sales office before using the product in an application that demands especially high quality and reliability or where its failure or malfunction may directly threaten human life or cause risk of bodily injury, such as aerospace, aeronautics, nuclear power, combustion control, transportation, traffic, safety equipment or medical equipment for life support.
4. Design your application so that the product is used within the ranges guaranteed by Hitachi particularly for maximum rating, operating supply voltage range, heat radiation characteristics, installation conditions and other characteristics. Hitachi bears no responsibility for failure or damage when used beyond the guaranteed ranges. Even within the guaranteed ranges, consider normally foreseeable failure rates or failure modes in semiconductor devices and employ systemic measures such as fail-safes, so that the equipment incorporating Hitachi product does not cause bodily injury, fire or other consequential damage due to operation of the Hitachi product.
5. This product is not designed to be radiation resistant.
6. No one is permitted to reproduce or duplicate, in any form, the whole or part of this document without written approval from Hitachi.
7. Contact Hitachi's sales office for any questions regarding this document or Hitachi semiconductor products.

HITACHI

Hitachi, Ltd.

Semiconductor & Integrated Circuits.
Nippon Bldg., 2-6-2, Ohte-machi, Chiyoda-ku, Tokyo 100-0004, Japan
Tel: Tokyo (03) 3270-2111 Fax: (03) 3270-5109

URL North America : <http://semiconductor.hitachi.com/>
 Europe : <http://www.hitachi-eu.com/hel/ecg>
 Asia (Singapore) : <http://www.has.hitachi.com.sg/grp3/sicd/index.htm>
 Asia (Taiwan) : http://www.hitachi.com.tw/E/Product/SICD_Frame.htm
 Asia (HongKong) : <http://www.hitachi.com.hk/eng/bo/grp3/index.htm>
 Japan : <http://www.hitachi.co.jp/Sicd/indx.htm>

For further information write to:

Hitachi Semiconductor
(America) Inc.
179 East Tasman Drive,
San Jose, CA 95134
Tel: <1> (408) 433-1990
Fax: <1> (408) 433-0223

Hitachi Europe GmbH
Electronic components Group
Dornacher Straße 3
D-85622 Feldkirchen, Munich
Germany
Tel: <49> (89) 9 9180-0
Fax: <49> (89) 9 29 30 00

Hitachi Europe Ltd.
Electronic Components Group.
Whitebrook Park
Lower Cookham Road
Maidenhead
Berkshire SL6 8YA, United Kingdom
Tel: <44> (1628) 585000
Fax: <44> (1628) 778322

Hitachi Asia Pte. Ltd.
16 Collyer Quay #20-00
Hitachi Tower
Singapore 049318
Tel: 535-2100
Fax: 535-1533

Hitachi Asia Ltd.
Taipei Branch Office
3F, Hung Kuo Building, No.167,
Tun-Hwa North Road, Taipei (105)
Tel: <886> (2) 2718-3666
Fax: <886> (2) 2718-8180

Hitachi Asia (Hong Kong) Ltd.
Group III (Electronic Components)
7/F., North Tower, World Finance Centre,
Harbour City, Canton Road, Tsim Sha Tsui,
Kowloon, Hong Kong
Tel: <852> (2) 735 9218
Fax: <852> (2) 730 0281
Telex: 40815 HITEC HX

Copyright ' Hitachi, Ltd., 1998. All rights reserved. Printed in Japan.

HITACHI