

High-side Power Switch with Diagnostic Function and Built-in Zener Diode SI-5153S

Features

- Built-in diagnostic function to detect short and open circuiting of loads and output status signals
- Low saturation PNP transistor use
- Allows direct driving using LS-TTL and C-MOS logic levels
- Built-in overcurrent and thermal protection circuits
- Built-in protection against reverse connection of power supply
- $T_j = 150^\circ\text{C}$ guaranteed
- Built-in Zener diode
- TO-220 equivalent full-mold package not require insulation mica

Absolute Maximum Ratings

($T_a = 25^\circ\text{C}$)

Parameter	Symbol	Ratings	Unit	Conditions
Power supply voltage	V_B	-13 to +40	V	
Input terminal voltage	V_{IN}	-0.3 to V_B	V	
DIAG terminal voltage	V_{DIAG}	6	V	
Collector-emitter voltage	V_{CE}	$V_B - V_Z$	V	Refer to "Surge clamp voltage" in Electrical Characteristics
Output current	I_O	2.04	A	
	P_{D1}	22	W	With infinite heatsink ($T_c = 25^\circ\text{C}$)
Power Dissipation	P_{D2}	1.8	W	Stand-alone without heatsink
	T_j	-40 to +150	$^\circ\text{C}$	
Operating temperature	T_{OP}	-40 to +100	$^\circ\text{C}$	
Storage temperature	T_{stg}	-40 to +150	$^\circ\text{C}$	

Electrical Characteristics

($T_a = 25^\circ\text{C}$ unless otherwise specified)

Parameter	Symbol	Ratings			Unit	Conditions
		min	typ	max		
Operating power supply voltage	V_{Bopr}	6.0		30	V	
Quiescent circuit current	I_q		5	12	mA	$V_{Bopr} = 14\text{V}$, $V_{IN} = 0\text{V}$
Saturation voltage of output transistor	$V_{CE(sat)}$			0.47	V	$I_O \leq 2.05\text{A}$, $V_{Bopr} = 6$ to 16V
Output leak current	$I_{O, leak}$			2	mA	$V_{CE0} = 16\text{V}$, $V_{IN} = 0\text{V}$
Input voltage	Output ON	V_{IH}	2.0	V_B	V	$V_{Bopr} = 6$ to 16V
	Output OFF	V_{IL}	-0.3	0.8	V	$V_{Bopr} = 6$ to 16V
Input current	Output ON	I_{IH}		1	mA	$V_{IN} = 5\text{V}$
	Output OFF	I_{IL}	-0.1		mA	$V_{IN} = 0\text{V}$
Overcurrent protection starting current	I_S	2.05			A	$V_{Bopr} = 14\text{V}$, $V_O = V_{Bopr} - 1.5\text{V}$
Thermal protection starting temperature	T_{TSD}	150			$^\circ\text{C}$	$V_{Bopr} \geq 6\text{V}$
Open load detection resistor	R_{open}			30	k Ω	$V_{Bopr} = 6$ to 16V
Output transfer time	T_{ON}		8	30	μs	$V_{Bopr} = 14\text{V}$, $I_O = 1\text{A}$
	T_{OFF}		15	30	μs	$V_{Bopr} = 14\text{V}$, $I_O = 1\text{A}$
DIAG output voltage	V_{DH}	4.5		6	V	$V_{CC} = 6\text{V}$, $V_{Bopr} = 6$ to 16V
	V_{DL}			0.3	V	$V_{CC} = 6\text{V}$, $V_{Bopr} = 6$ to 16V , $I_{DO} = 2\text{mA}$
DIAG output transfer time	T_{PLH}			30	μs	$V_{Bopr} = 14\text{V}$, $I_O = 1\text{A}$
	T_{PHL}			30	μs	$V_{Bopr} = 14\text{V}$, $I_O = 1\text{A}$
Minimum load inductance	L	1			mH	
Surge clamp voltage	V_Z	28	34	40	V	$I_C = 5\text{mA}$

Note:

*1. The Zener diode for surge clamping has an energy capability of 140 mJ (single pulse).

* The rule of protection against reverse connection of power supply is $V_B = -13\text{V}$, one minute.

* This driver is exclusively used for ON/OFF control.

External Dimensions (unit: mm)

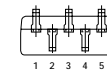
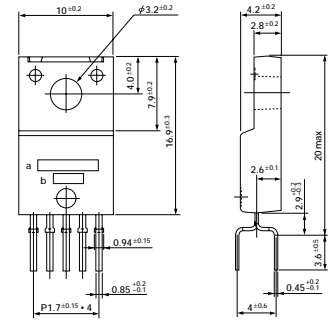

1. GND
 2. V_{IN}
 3. V_O
 4. DIAG
 5. V_B
- a: Type No.
b: Lot No.

(Forming No. 1111)

Standard Circuit Diagram

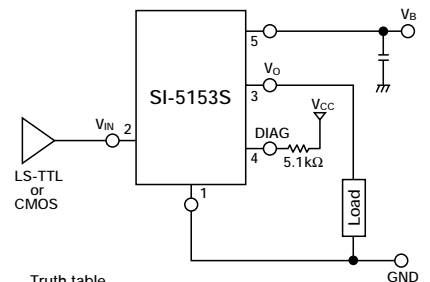

Truth table

V_{IN}	V_O
H	H
L	L

Diagnostic Function

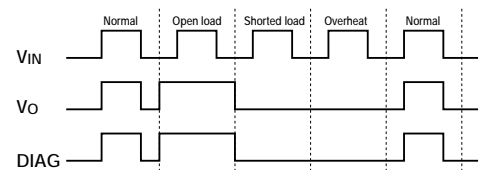

Mode	V_{IN}	V_O	DIAG
Normal	L	H	L
Open load	L	H	H
Shorted load	L	L	L
Overheat	L	L	L

- DIAG output will be undetermined when a voltage exceeding 25V is applied to V_B terminal.

■ Quiescent Circuit Current

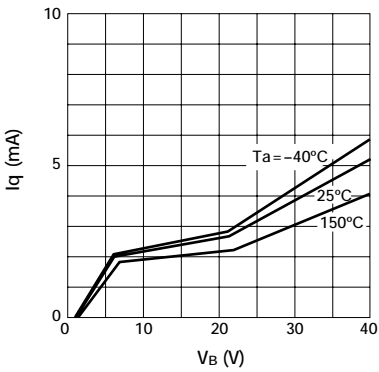

■ Circuit Current

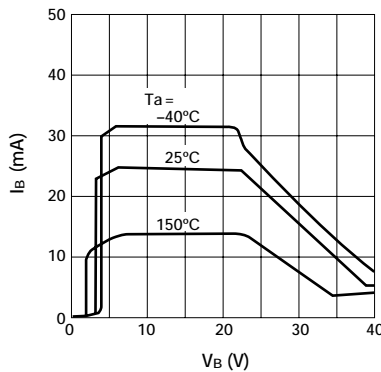

■ Saturation Voltage of Output Transistor

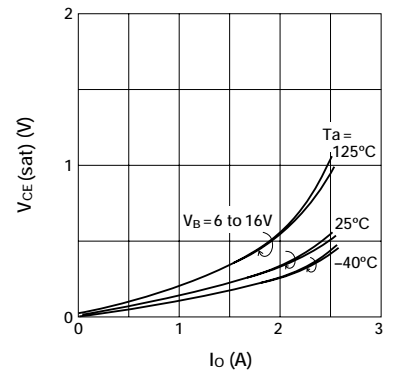

■ Overcurrent Protection Characteristics ($T_a = -40^\circ\text{C}$)

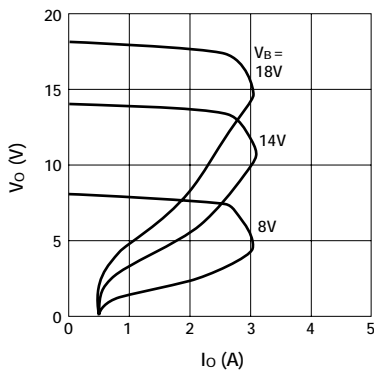

■ Overcurrent Protection Characteristics ($T_a = 25^\circ\text{C}$)

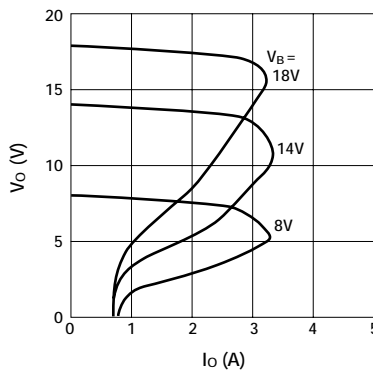

■ Overcurrent Protection Characteristics ($T_a = 125^\circ\text{C}$)

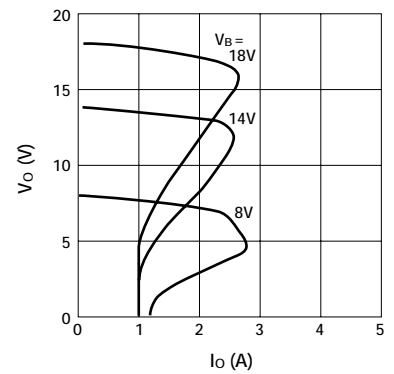

■ Threshold Characteristics of Input Voltage

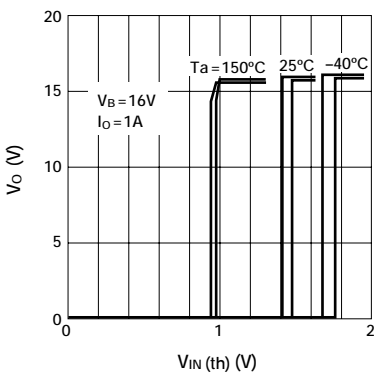

■ Input Current (Output ON)

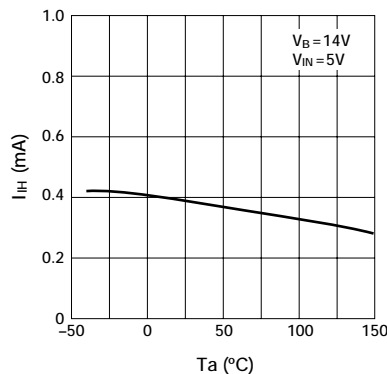

■ Input Current (Output OFF)

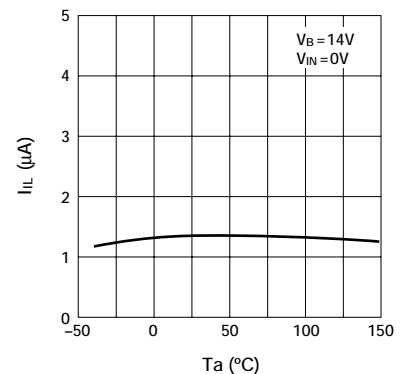

■ Output Terminal Leak Current

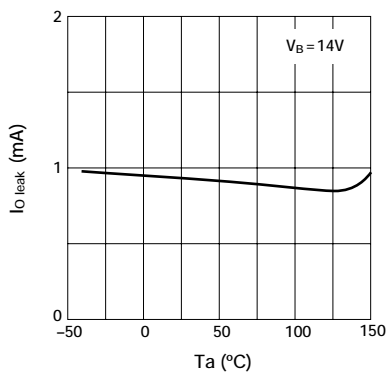

■ Saturation Voltage of DIAG Output

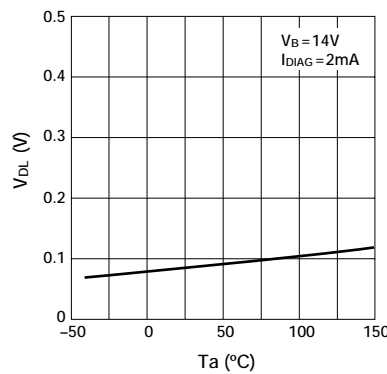

■ Thermal Protection Characteristics

