



DC COMPONENTS CO., LTD.

RECTIFIER SPECIALISTS

**RGL34A
THRU
RGL34J**

TECHNICAL SPECIFICATIONS OF SURFACE MOUNT FAST RECOVERY RECTIFIER

VOLTAGE RANGE - 50 to 600 Volts

CURRENT -0.5 Ampere

FEATURES

- * Ideal for surface mounted applications
- * Low leakage current
- * Fast switching
- * Glass passivated junction

MECHANICAL DATA

- * Case: Molded plastic
- * Epoxy: UL 94V-0 rate flame retardant
- * Terminals: Solder plated solderable per MIL-STD-202E, Method 208 guaranteed
- * Polarity: Color band denotes cathode end
- * Mounting position: Any
- * Weight: 0.036 gram

MAXIMUM RATINGS AND ELECTRICAL CHARACTERISTICS

Ratings at 25 °C ambient temperature unless otherwise specified.
Single phase, half wave, 60 Hz, resistive or inductive load.
For capacitive load, derate current by 20%.



SM-2(DO-213AA)

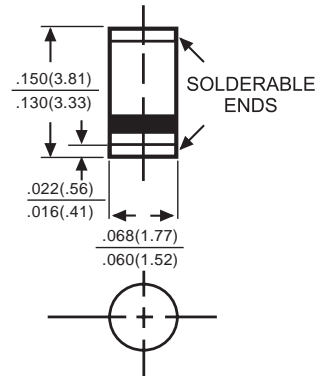

Dimensions in inches and (millimeters)

	SYMBOL	RGL34A	RGL34B	RGL34D	RGL34G	RGL34J	UNITS
Maximum Recurrent Peak Reverse Voltage	V _{RRM}	50	100	200	400	600	Volts
Maximum RMS Voltage	V _{RMS}	35	70	140	280	420	Volts
Maximum DC Blocking Voltage	V _{DC}	50	100	200	400	600	Volts
Maximum Average Forward Rectified Current T _A = 55°C	I _O	0.5					Amps
Peak Forward Surge Current I _{FM} (surge): 8.3 ms single half sine-wave superimposed on rated load (JEDEC Method)	I _{FSM}	10					Amps
Maximum Forward Voltage at 0.5A DC	V _F	1.3					Volts
Maximum DC Reverse Current at Rated DC Blocking Voltage	I _R	5.0					uAmps
@ T _A = 125°C		100					
Maximum Reverse Recovery Time (Note 3)	t _{rr}	150				250	nSec
Maximum Thermal Resistance (Note 2)	R _{θJL}	70					°C/W
Typical Junction Capacitance (Note 1)	C _J	4.0					pF
Operating and Storage Temperature Range	T _J , T _{STG}	-65 to + 175					°C

NOTES : 1. Measured at 1.0 MHz and applied reverse voltage of 4.0VDC
 2. Thermal resistance (Junction to Ambient) .24in² (6.0mm²) copper pads to each terminal.
 3. Test Conditions: I_F = 0.5A, I_R=1.0A, I_{RR}=0.25A

RATING AND CHARACTERISTIC CURVES (RGL34A THRU RGL34J)

FIG. 1 - TYPICAL FORWARD CURRENT DERATING CURVE

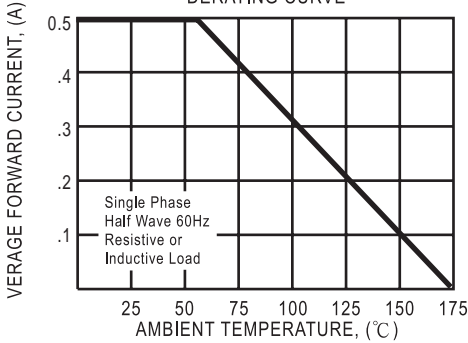

FIG. 2 - MAXIMUM NON-REPETITIVE FORWARD SURGE CURRENT

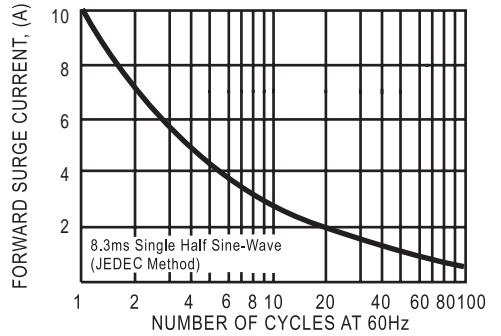

FIG. 3 - TYPICAL REVERSE CHARACTERISTICS

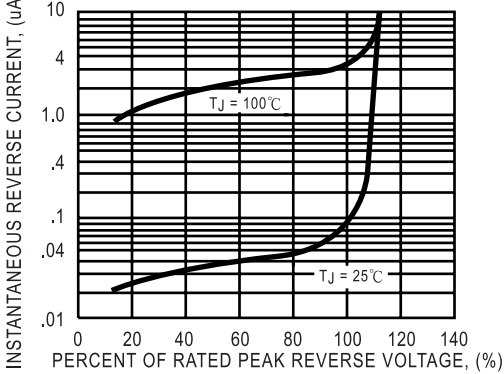

FIG. 4 - TYPICAL INSTANTANEOUS FORWARD CHARACTERISTICS

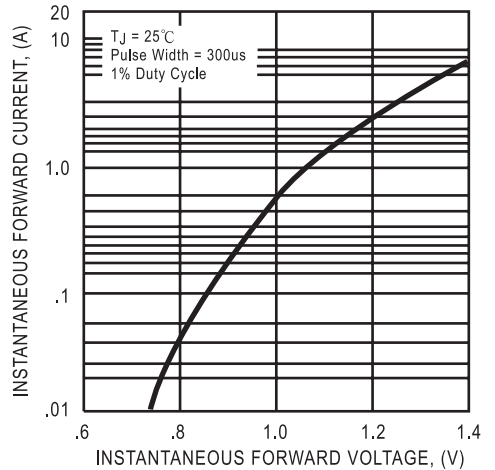

FIG. 5 - TEST CIRCUIT DIAGRAM AND REVERSE RECOVERY TIME CHARACTERISTIC

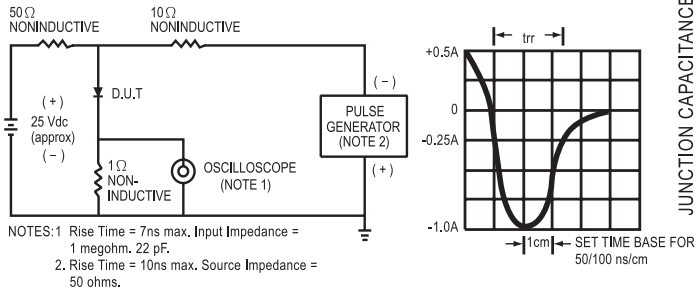
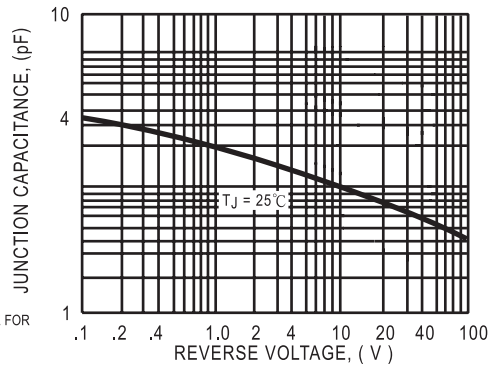

FIG. 6 - TYPICAL JUNCTION CAPACITANCE



DC COMPONENTS CO., LTD.