

Features

- For AF driver and output stages
- High collector current
- Low collector-emitter saturation voltage
- Complementary types: BCX 54 ... BCX 56 (NPN)

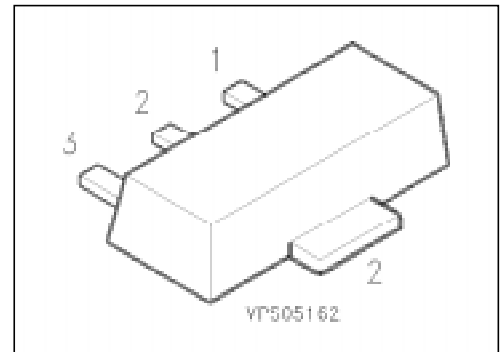

Type	Marking	Ordering Code (tape and reel)	Pin Configuration			Package ¹⁾
			1	2	3	
BCX 51	AA	Q62702-C1847	B	C	E	SOT-89
BCX 51-10	AC	Q62702-C1831				
BCX 51-16	AD	Q62702-C1857				
BCX 52	AE	Q62702-C1743				
BCX 52-10	AG	Q62702-C1744				
BCX 52-16	AM	Q62702-C1900				
BCX 53	AH	Q62702-C905				
BCX 53-10	AK	Q62702-C1753				
BCX 53-16	AL	Q62702-C1502				

¹⁾ For detailed information see chapter Package Outlines.

Maximum Ratings

Parameter	Symbol	Values			Unit
		BCX 51	BCX 52	BCX 53	
Collector-emitter voltage	V_{CE0}	45	60	80	V
Collector-base voltage	V_{CB0}	45	60	100	
Emitter-base voltage	V_{EB0}	5	5	5	
Collector current	I_C	1			A
Peak collector current	I_{CM}	1.5			
Base current	I_B	100			mA
Peak base current	I_{BM}	200			
Total power dissipation, $T_s = 130\text{ °C}$	P_{tot}	1			W
Junction temperature	T_j	150			°C
Storage temperature range	T_{stg}	- 65 ... + 150			

Thermal Resistance

Junction - ambient ¹⁾	$R_{th JA}$	≤ 75	K/W
Junction - soldering point	$R_{th JS}$	≤ 20	

¹⁾ Package mounted on epoxy pcb 40 mm × 40 mm × 1.5 mm/6 cm² Cu.

Electrical Characteristics

at $T_A = 25\text{ °C}$, unless otherwise specified.

Parameter	Symbol	Values			Unit
		min.	typ.	max.	

DC characteristics

Collector-emitter breakdown voltage $I_C = 10\text{ mA}$	$V_{(BR)CE0}$				V
BCX 51		45	–	–	
BCX 52		60	–	–	
BCX 53		80	–	–	
Collector-base breakdown voltage $I_C = 100\text{ }\mu\text{A}$	$V_{(BR)CB0}$				
BCX 51		45	–	–	
BCX 52		60	–	–	
BCX 53		100	–	–	
Emitter-base breakdown voltage $I_E = 10\text{ }\mu\text{A}$	$V_{(BR)EB0}$	5	–	–	
Collector cutoff current $V_{CB} = 30\text{ V}$ $V_{CB} = 30\text{ V}, T_A = 150\text{ °C}$	I_{CB0}	–	–	100	nA
		–	–	20	μA
Emitter cutoff current $V_{EB} = 4\text{ V}$	I_{EB0}	–	–	20	nA
DC current gain ¹⁾ $I_C = 5\text{ mA}, V_{CE} = 2\text{ V}$ $I_C = 150\text{ mA}, V_{CE} = 2\text{ V}$ BCX 51, BCX 52, BCX 53 BCX 51-10, BCX 52-10, BCX 53-10 BCX 51-16, BCX 52-16, BCX 53-16 $I_C = 500\text{ mA}, V_{CE} = 2\text{ V}$	h_{FE}	25	–	–	–
		40	–	250	
		63	100	160	
		100	160	250	
		25	–	–	
Collector-emitter saturation voltage ¹⁾ $I_C = 500\text{ mA}, I_B = 50\text{ mA}$	V_{CEsat}	–	–	0.5	V
Base-emitter voltage ¹⁾ $I_C = 500\text{ mA}, V_{CE} = 2\text{ V}$	V_{BE}	–	–	1	

AC characteristics

Transition frequency $I_C = 50\text{ mA}, V_{CE} = 10\text{ V}, f = 20\text{ MHz}$	f_T	–	125	–	MHz
---	-------	---	-----	---	-----

¹⁾ Pulse test: $t \leq 300\text{ }\mu\text{s}, D = 2\%$.

Total power dissipation $P_{tot} = f(T_A^*; T_S)$

* Package mounted on epoxy

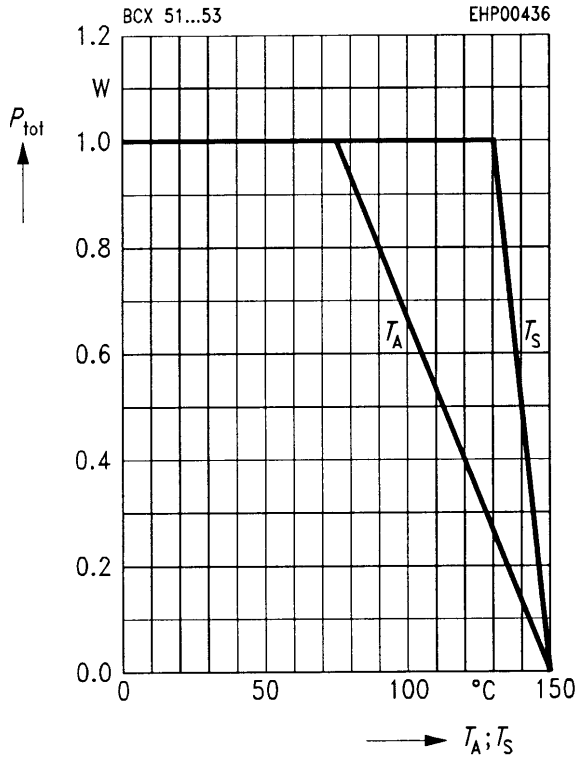

Collector current $I_C = f(V_{BE})$

$V_{CE} = 2\text{ V}$

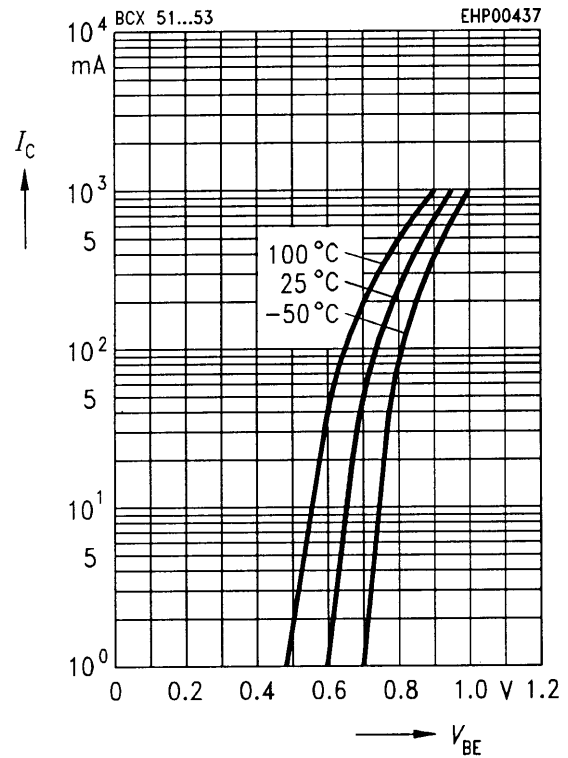

Permissible pulse load $P_{tot\ max}/P_{tot\ DC} = f(t_p)$

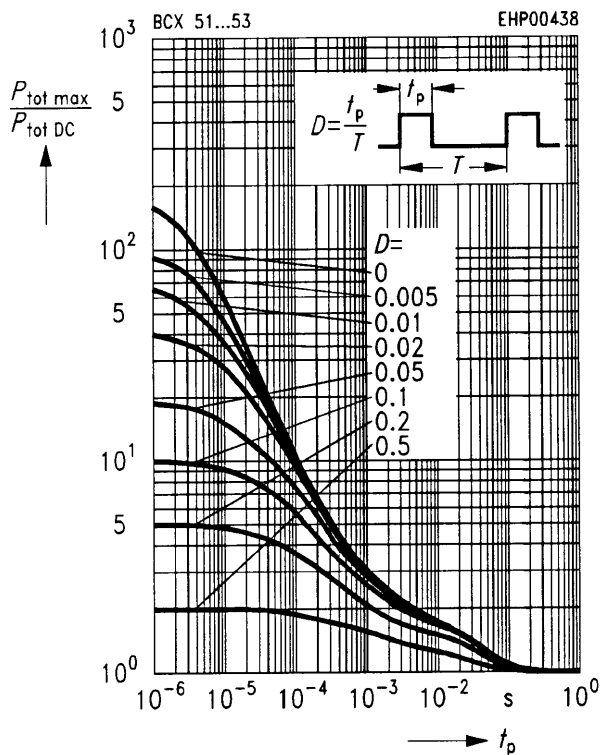

Transition frequency $f_T = f(I_C)$

$V_{CE} = 10\text{ V}$

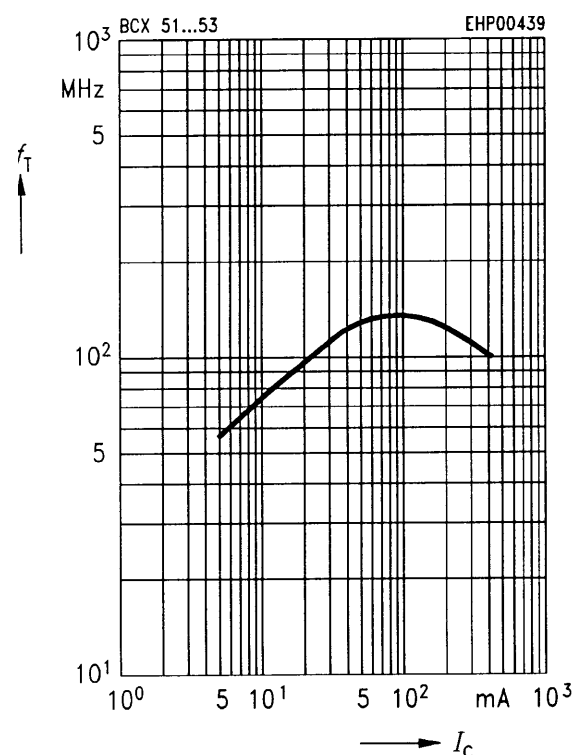

DC current gain $h_{FE} = f(I_C)$

$V_{CE} = 2 \text{ V}$

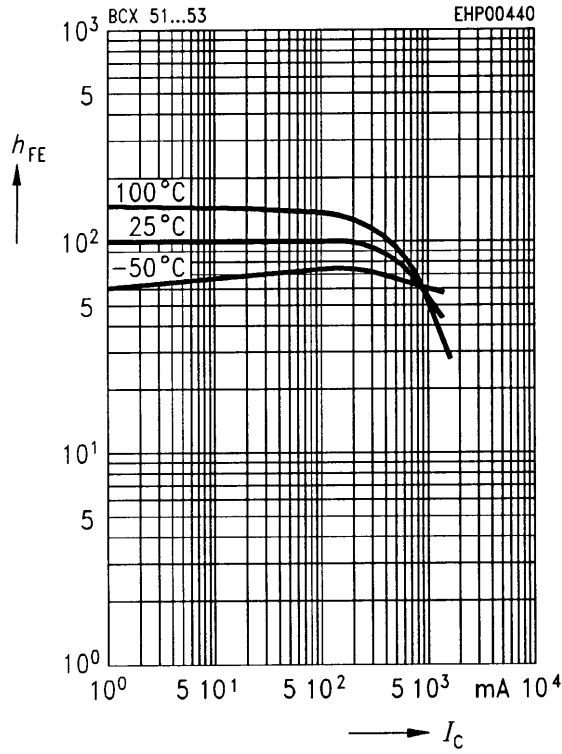

Collector-emitter saturation voltage $I_C = f(V_{CEsat})$

$I_C = f(V_{CEsat})$

$h_{FE} = 10$

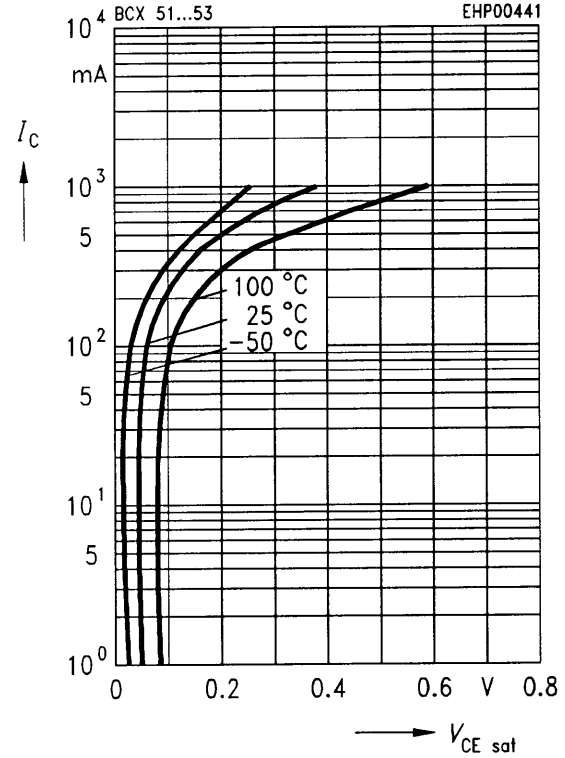

Collector cutoff current $I_{CB0} = f(T_A)$

$V_{CB} = 30 \text{ V}$

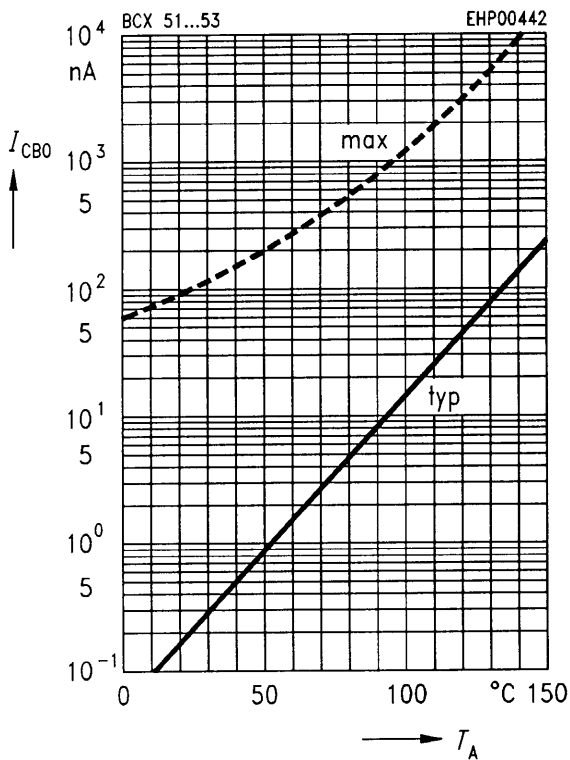

Base-emitter saturation voltage $I_C = f(V_{BEsat})$

$I_C = f(V_{BEsat})$

$h_{FE} = 10$

