

DESCRIPTION

The ULN2803/2804 series are high-voltage, high-current darlington arrays comprised of eight NPN darlington pairs. All units feature integral clamp diodes for switching inductive loads.

FEATURES

- Output current.....500mA
- High Sustaining Voltage.....50V Min.
- Output Clamp Diode
- Inputs Compatible With Various Types of Logic

Type	Input Resistor	Designation
ULN2803	2.7K Ω	TTL, 5V C-MOS
ULN2804	10.5K Ω	6~15V P-MOS, C-MOS

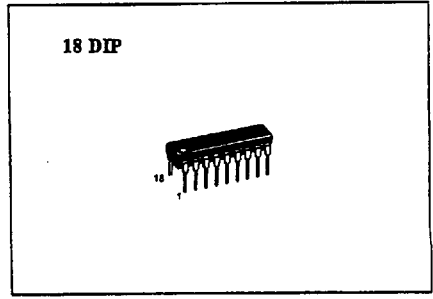

MAXIMUM RATING(Ta=25°C unless otherwise)

Characteristic	Symbol	Rating	Unit
Output Sustaining Voltage	$V_{CE(SUS)}$	50	V
Output Current	I_{OUT}	500	mA
Input Voltage	V_{IN*}	-0.5~+30	V
Input Current	I_{IN*}	25	mA
Clamp Diode	Reverse Voltage	V_R	50 V
	Forward Current	I_F	500 mA
GND Terminal Current	I_{GND}	3.2	A
Power Dissipation	P_D	1.47	W
Operating Temperature	T_{opr}	-40~85	°C
Storage Temperature	T_{stg}	-55~150	°C

PIN CONNECTION (TOP VIEW)

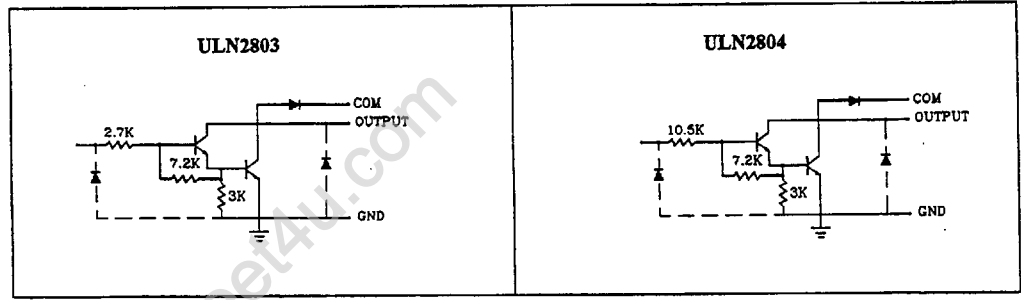
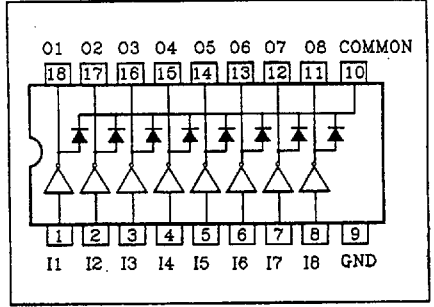

RECOMMENDED OPERATING CONDITIONS(Ta=-40-85°C)

CHARACTERISTIC	SYMBOL	CONDITION	MIN.	TYP.	MAX.	UNIT
Output Sustaining Voltage	V _{CE(SUS)}		0	-	50	V
Output Current	I _{OUT}	T _{FW} =25mS,DF=8%, 8 Circuits	0	-	400	mA
		T _{FW} =25mS,DF=25% 8 Circuits	0	-	200	mA
Input Voltage	V _{IN}		0	-	30	V
Clamp Diode Reverse Voltage	V _R		-	-	50	V
Clamp Diode Forward Current	I _F		-	-	400	mA
Power Dissipation	P _D		-	-	0.52	W

ELECTRICAL CHARACTERISTICS(Ta=25°C unless otherwise noted)

CHARACTERISTIC	SYMBOL	TEST CIRCUIT	CONDITION	MIN.	TYP.	MAX.	UNIT
Output leak Current	I _{CEX}	1	V _{CE} =50V, Ta=25°C	-	-	50	μ A
			V _{CE} =50V, Ta=85°C	-	-	100	
			V _{CE} =50V, V _{IN} =-1V	-	-	500	
Collector-Emitter Saturation Voltage	V _{CE(sat)}	2	I _{OUT} =350mA, I _N =500μ A	-	1.3	1.6	V
			I _{OUT} =200mA, I _N =350μ A	-	1.1	1.3	
			I _{OUT} =100mA, I _N =250μ A	-	0.9	1.1	
Input Current	ULN2803	I _{IN(on)}	V _{IN} =3.85V	-	0.93	1.35	mA
			V _{IN} =5V	-	0.35	0.5	
	ULN2804		V _{IN} =12V	-	1.0	1.45	
			I _{OUT} =500μ A, Ta=85°C	50	65	-	
Input Voltage	ULN2803	V _{IN(ON)}	V _{CE} =2V, I _{OUT} =200mA	-	-	2.4	V
			V _{CE} =2V, I _{OUT} =250mA	-	-	2.7	
			V _{CE} =2V, I _{OUT} =300mA	-	-	3.0	
	ULN2804		V _{CE} =2V, I _{OUT} =125mA	-	-	5.0	
			V _{CE} =2V, I _{OUT} =200mA	-	-	6.0	
			V _{CE} =2V, I _{OUT} =275mA	-	-	7.0	
			V _{CE} =2V, I _{OUT} =350mA	-	-	8.0	
DC Current Transistor Ratio	h _{FE}	2	V _{CE} =2V, I _{OUT} =350mA	1000	-	-	
Clamp Diode Reverse Current	I _E	6	V _R =50V, Ta=25°C	-	-	50	μ A
Clamp Diode Forward Voltage	V _F	7	V _R =50V, Ta=85°C	-	-	100	V
			I _F =350mA	-	-	2.0	
Input Capacitance	C _{IN}			-	15	-	pF
Turn-On Delay	t _{ON}	8	V _{OUT} =50V, R _L =163Ω	-	0.1	-	μ S
Turn-Off Delay	t _{OFF}			-	0.2	-	

TEST CIRCUIT

1. I_{CEX}

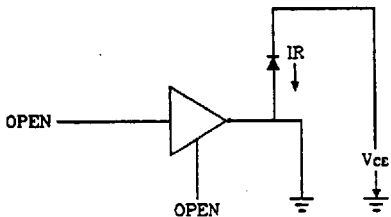

2. $V_{CE(sat)}$, h_{FE}

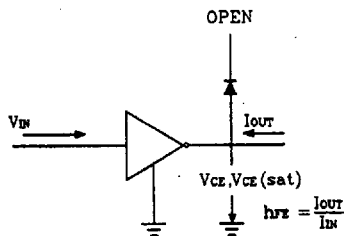

3. $I_{IN(ON)}$

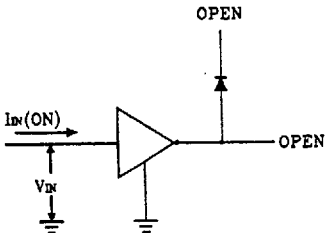

4. $I_{IN(OFF)}$

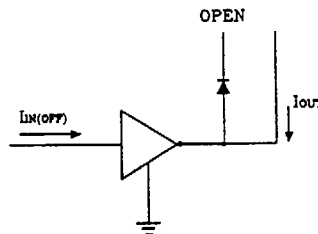

5. $V_{IN(ON)}$

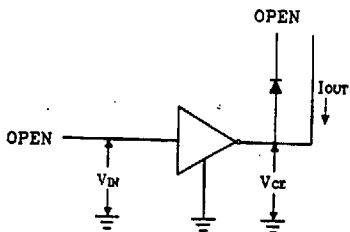

6. I_R

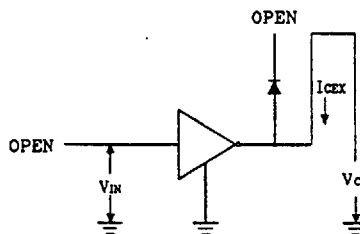

7. V_F

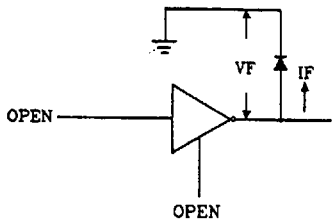

8. t_{ON} , t_{OFF}

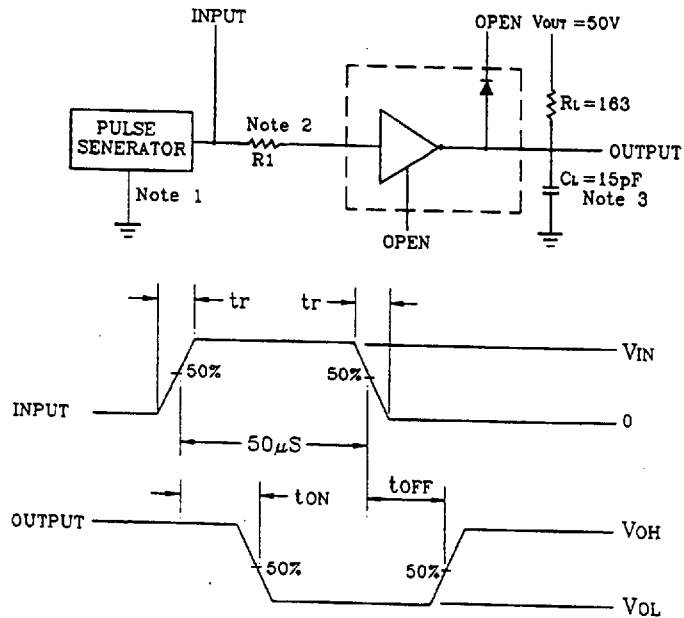

Notes: 1. Pulse Width $50\mu s$, Duty Cycle 10%

Output Impedance 50Ω

$t_r \leq 5ns$, $t_f \leq 10ns$

2. See below

Input Conditions

TYPE NUMBER	R_L	V_{IH}
ULN2803	0	3V
ULN2804	0	8V

3. C_L includes prob and jig capacitance.

ULN2803 $I_{IN} - V_{IN}$

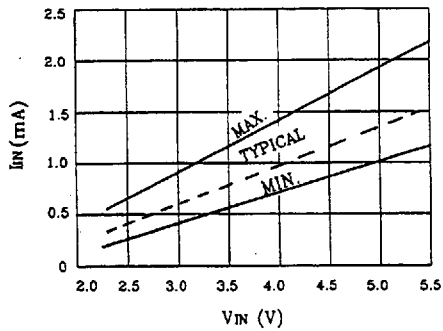

ULN2804 $I_{IN} - V_{IN}$

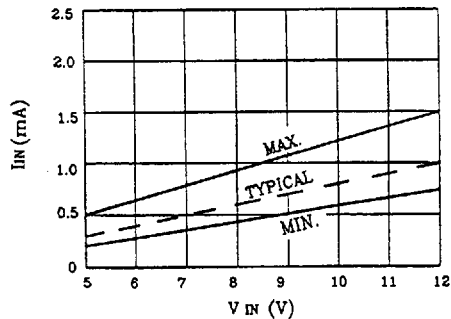

$F_D - T_a$

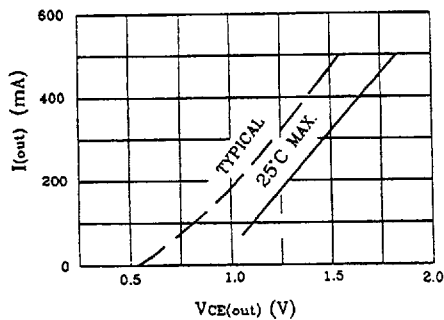

$I_{OUT} - V_{CE(out)}$

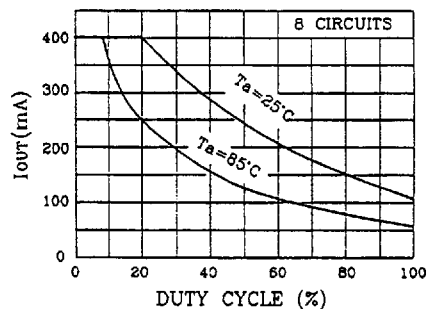

$I_{OUT} - DUTY CYCLE$

