

SLOTTED OPTICAL SWITCHES PHOTO INTEGRATED CIRCUIT KT930 - KT940 SERIES

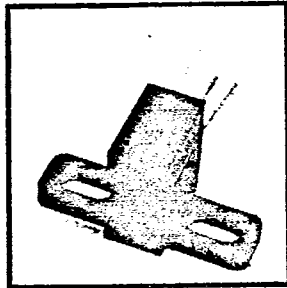

Optek Technology, Inc
345 Industrial Blvd.
McKinney, Texas 75069
(214) 542-9461



PACKAGE L

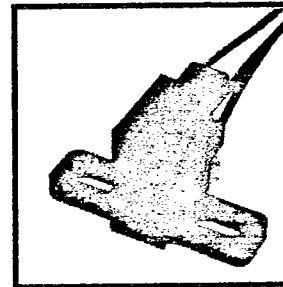

PACKAGE W

DESCRIPTION

The KT930/KT940 series of Photo Integrated Circuit (P.I.C.) Switches provides optimum flexibility for the design engineer. Building from a standard housing with a .125" wide slot, the user can specify (1) type and polarity of TTL output, (2) Lead or wire termination, (3) discrete shell, and (4) aperture width.

The electrical output can be specified as either TTL totem pole or TTL open collector. Either may be supplied with inverter or buffer output polarity. All have the added stability of a built-in hysteresis amplifier.

All housings are an opaque grade of injection-molded polysulfone (P1700-935) to minimize the assembly's sensitivity to ambient radiation, both visible and near-infrared. Discrete shells (exposed only on the parallel faces inside the device throat) are either IR transmissive polysulfone (P1700-1615) for applications where aperture contamination may occur, or opaque polysulfone where maximum protection against ambient radiation is a concern.

The "W" series of switches are terminated with 24 inches of 7 strand, 26 AWG, UL 1429 insulated wire on each terminal. Insulation colors and functions are:

RED - IRED Anode
BLACK - IRED Cathode

WHITE - Vcc
BLUE - Output
GREEN - Ground

Other wire lengths and/or colors are available. Contact your local representative or call the factory.

JANUARY 1987

PART NUMBER GUIDE

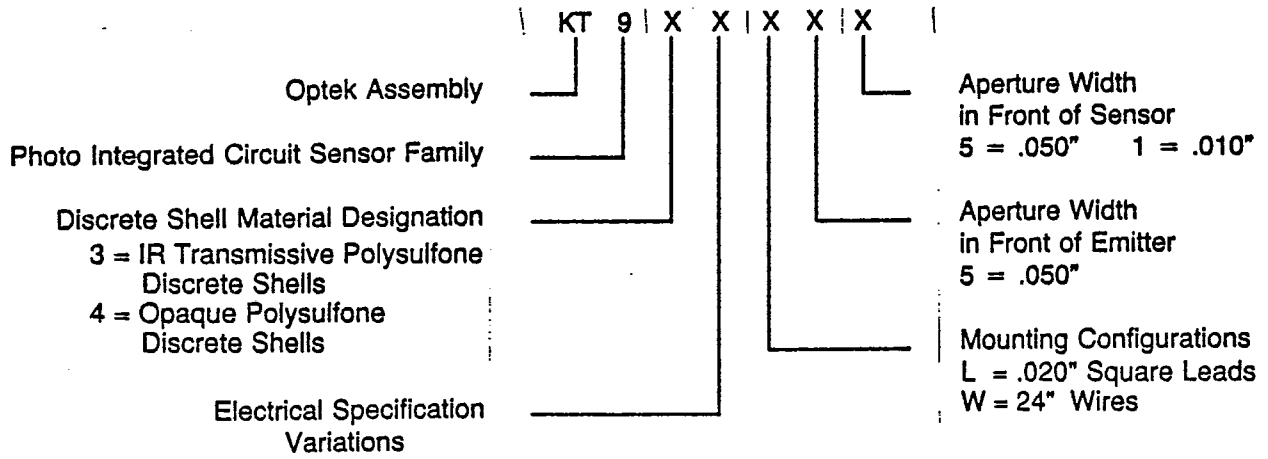

- 0 = Buffer with Totem-Pole Output
- 1 = Buffer with Open-Collector Output
- 2 = Inverter with Totem-Pole Output
- 3 = Inverter with Open-Collector Output

EXAMPLE

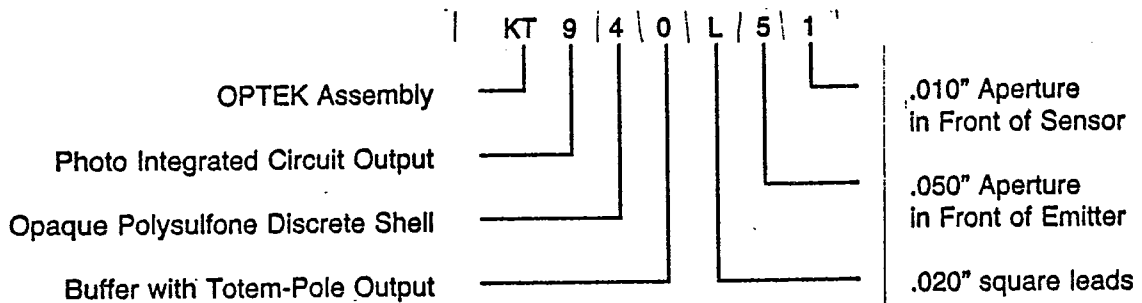

OPTEK TECHNOLOGY reserves the right to make changes at anytime without prior notice.

KT930 - KT940 W SERIES

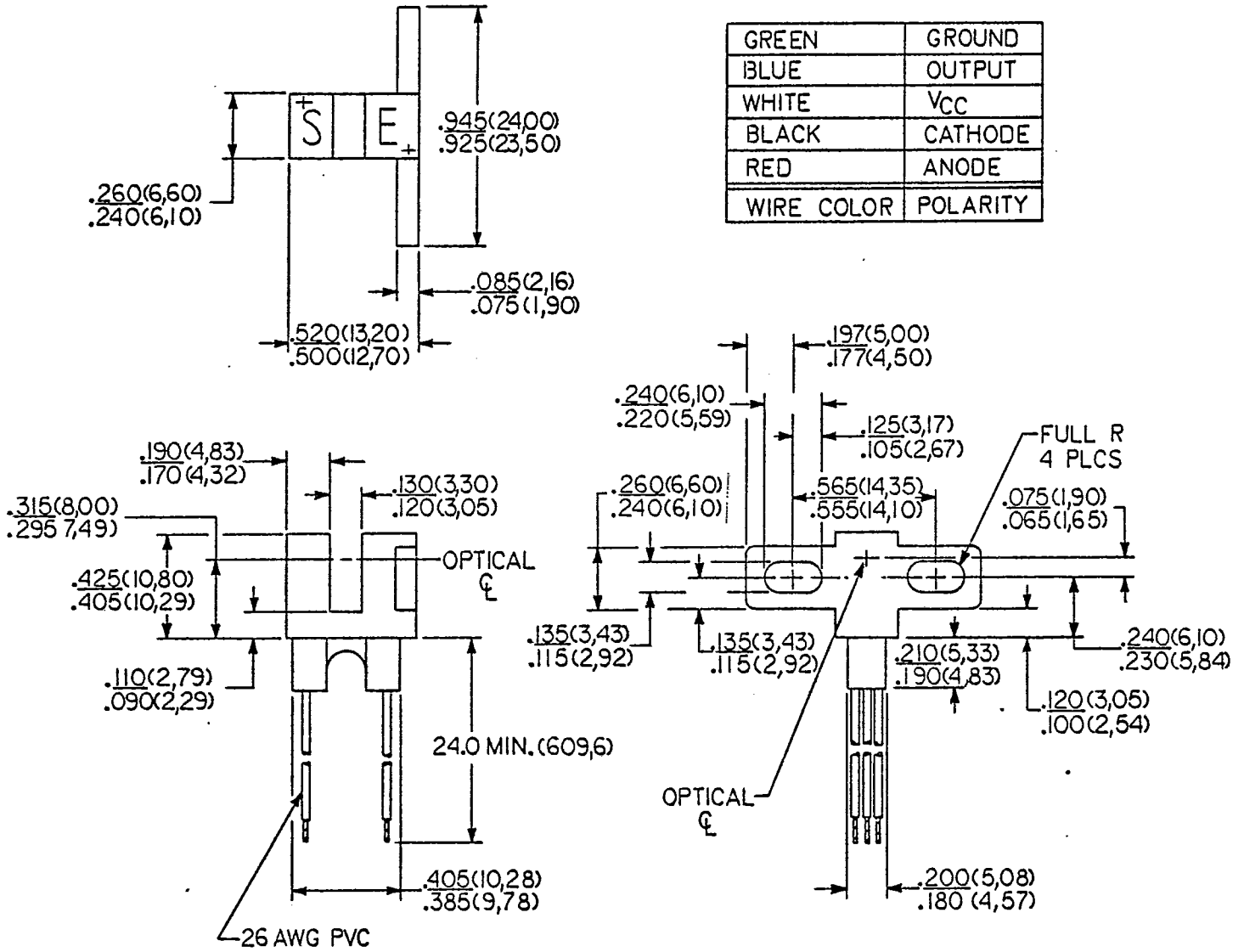

WIRE COLOR	POLARITY
GREEN	GROUND
BLUE	OUTPUT
WHITE	VCC
BLACK	CATHODE
RED	ANODE

NOTE:
 Housing is soluble in chlorinated hydrocarbons and ketones.
 Methanol or isopropanol are recommended as a cleaning agent.

KT931/KT941

KT933/KT943

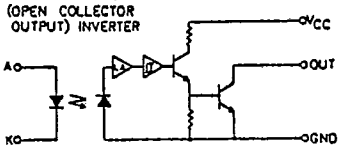
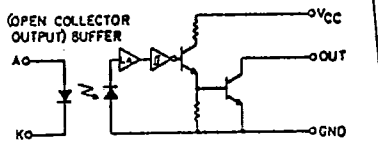

ABSOLUTE MAXIMUM RATINGS (25 °C unless otherwise noted)

Supply Voltage, Vcc (Not to exceed 3 seconds)	+ 10V
Storage Temperature Range	-40°C to +100°C
Operating Temperature Range	-40°C to +70°C
Lead Soldering Temperature (1/16" from case for 5 seconds with soldering iron)	+240°C
Input Diode Power Dissipation	100 mW (B)
Output Photologic Power Dissipation	200 mW (D)
Total Device Power Dissipation	300 mW (E)
Voltage at Output Lead (Open Collector Output)	35 V
Diode Forward D.C. Current	40 mA
Diode Reverse D.C. Voltage	3 V

- Notes:
- (A) RMA flux is recommended. Duration can be extended to 10 seconds maximum when soldering.
 - (B) Derate linearly 1.33mW/°C above 25°C
 - (C) Normal application would be with light source blocked, simulated by $I_f = 0$
 - (D) Derate linearly 2.67 mW/°C above 25°C
 - (E) Derate linearly 4.0 mW/°C above 25°C

MECHANICAL CONSTRUCTION

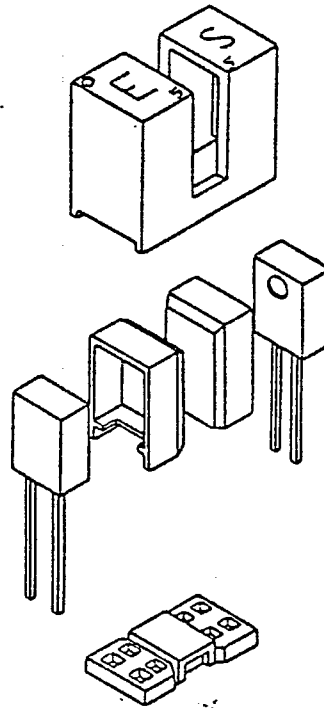

All housings are an opaque grade of injection-molded polysulfone (P1700-935) to minimize the assembly's sensitivity to ambient radiation, both visible and near-infrared. Discrete Shells (exposed only on the parallel faces inside the device throat) are either IR transmissive polysulfone (P1700-1615) for applications where aperture contamination may occur, or opaque polysulfone where maximum protection against ambient radiation is a concern.

4

TYPES KT930/KT 940 SERIES

ELECTRICAL CHARACTERISTICS (-40°C TO +70°C UNLESS OTHERWISE NOTED)

SYMBOL	PARAMETER	MIN	TYP	MAX	UNITS	TEST CONDITIONS
INPUT DIODE						
V_F	FORWARD VOLTAGE			1.5	V	$I_F = 20\text{mA}, T_A = 25^\circ\text{C}$
I_R	REVERSE CURRENT			100	μA	$V_R = 3\text{V}, T_A = 25^\circ\text{C}$
OUTPUT PHOTO INTEGRATED CIRCUIT SENSOR						
V_{CC}	OPERATING SUPPLY VOLTAGE	4.75		5.25	V	
I_{CCL}	LOW LEVEL SUPPLY CURRENT: BUFFER WITH TOTEM-POLE OUTPUT BUFFER WITH OPEN-COLLECTOR INVERTER WITH TOTEM-POLE OUTPUT INVERTER WITH OPEN-COLLECTOR			15 15 15 15	mA mA mA mA	$V_{CC} = 5.25\text{V}, I_F = 0\text{mA}^{(1)}$ $V_{CC} = 5.25\text{V}, I_F = 0\text{mA}^{(2)}$ $V_{CC} = 5.25\text{V}, I_F = 20\text{mA}$ $V_{CC} = 5.25\text{V}, I_F = 20\text{mA}$
I_{CCH}	HIGH LEVEL SUPPLY CURRENT: BUFFER WITH TOTEM-POLE OUTPUT BUFFER WITH OPEN-COLLECTOR INVERTER WITH TOTEM-POLE OUTPUT INVERTER WITH OPEN-COLLECTOR			15 15 15 15	mA mA mA mA	$V_{CC} = 5.25\text{V}, I_F = 20\text{mA}$ $V_{CC} = 5.25\text{V}, I_F = 20\text{mA}$ $V_{CC} = 5.25\text{V}, I_F = 0\text{mA}^{(1)}$ $V_{CC} = 5.25\text{V}, I_F = 0\text{mA}^{(2)}$
V_{OL}	LOW LEVEL OUTPUT VOLTAGE BUFFER WITH TOTEM-POLE OUTPUT BUFFER WITH OPEN-COLLECTOR INVERTER WITH TOTEM-POLE INVERTER WITH OPEN-COLLECTOR			0.4 0.4 0.4 0.4	V V V V	$V_{CC} = 4.75\text{V}, I_{OL} = 12.8\text{mA}$ $I_F = 0\text{mA}^{(1)}$ $V_{CC} = 4.75\text{V}, I_{OL} = 12.8\text{mA}$ $I_F = 0\text{mA}^{(2)}$ $V_{CC} = 4.75\text{V}, I_{OL} = 12.8\text{mA}$ $I_F = 20\text{mA}$ $V_{CC} = 4.75\text{V}, I_{OL} = 12.8\text{mA}$ $I_F = 20\text{mA}$
V_{OH}	HIGH LEVEL OUTPUT VOLTAGE BUFFER WITH TOTEM-POLE INVERTER WITH TOTEM-POLE	2.4 2.4			V V	$V_{CC} = 4.75\text{V}, I_{OH} = 800\mu\text{A}$ $I_F = 20\text{mA}$ $V_{CC} = 4.75\text{V}, I_{OH} = 800\mu\text{A}$ $I_F = 0\text{mA}^{(1)}$
I_{OH}	HIGH LEVEL OUTPUT CURRENT BUFFER WITH OPEN-COLLECTOR INVERTER WITH OPEN-COLLECTOR			100 100	μA μA	$V_{CC} = 4.75\text{V}, V_{OH} = 30\text{V}$ $I_F = 20\text{mA}$ $V_{CC} = 4.75\text{V}, V_{OH} = 30\text{V}$ $I_F = 0\text{mA} \quad T_A = 25^\circ\text{C}$
$I_{F(+)}$	LED POSITIVE-GOING THRESHOLD CURRENT			20	mA	$V_{CC} = 5\text{V}$
$I_{F(+)} I_{F(-)}$	HYSTERESIS		2			$V_{CC} = 5\text{V}$
I_{OS}	SHORT CIRCUIT OUTPUT CURRENT BUFFER WITH TOTEM-POLE INVERTER WITH TOTEM-POLE	-30 -30		-100 -100	mA mA	$V_{CC} = 5.25\text{V}, I_F = 20\text{mA}$ OUTPUT = GND $V_{CC} = 5.25\text{V}, I_F = 0\text{mA}$ OUTPUT = GND
T_R, T_F	OUTPUT RISE TIME OUTPUT FALL TIME			70	ns	$V_{CC} = 5\text{V}, T_A = 25^\circ$
T_{PLH}, T_{PHL}	PROPAGATION DELAY LOW-HIGH & HIGH-LOW			5	us	$I_F = 0$ or 20 mA $I_F = 0$ or 20 mA $R_L = 8\text{TTL Loads (Totem Pole)}$ $R_L = 360 \Omega$ (Open Collector)

KT930 - KT940 L SERIES

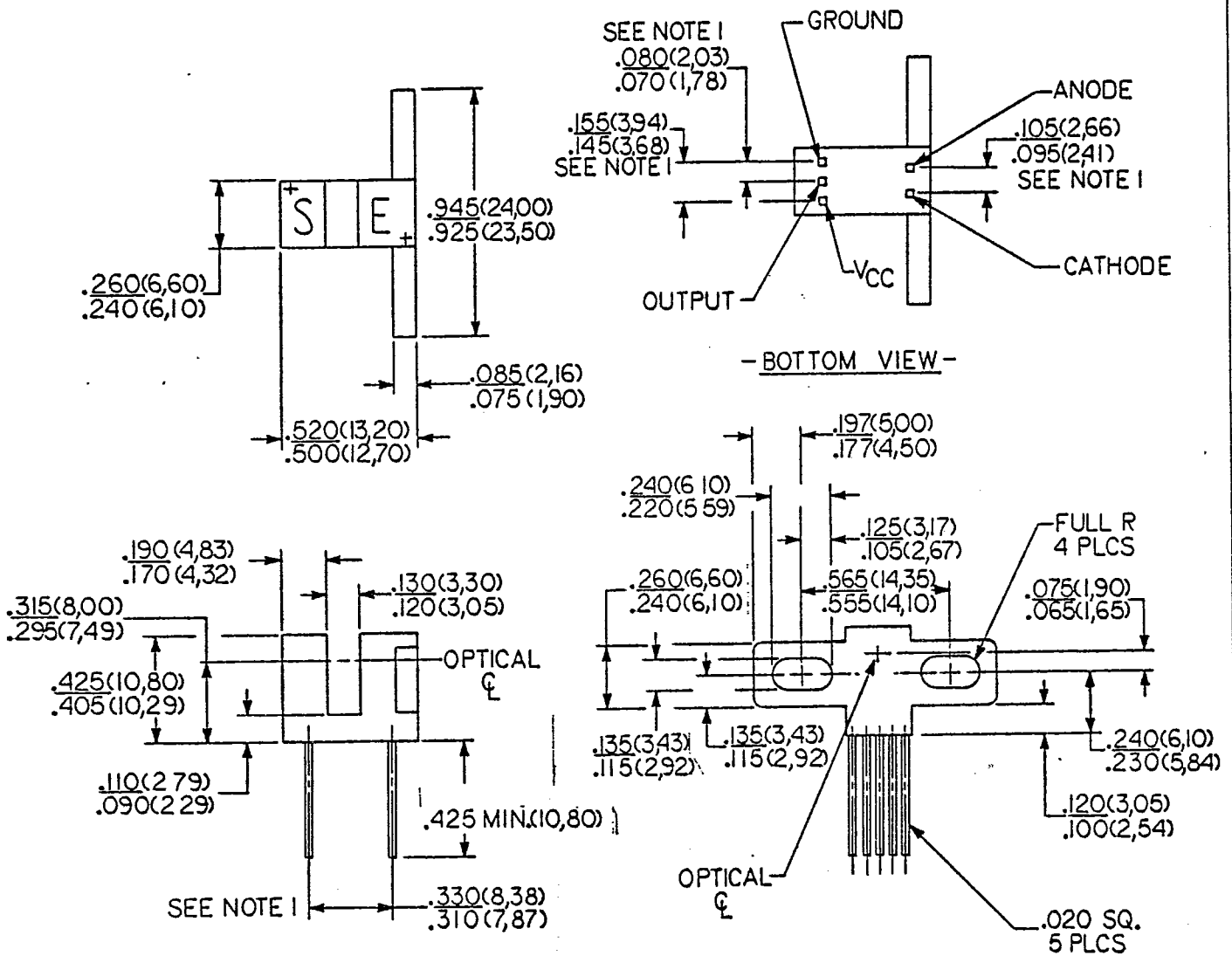

NOTES:

1. Dimension controlled at housing surface only.
2. KT930L thru KT923L and KT940L lead spacing: .320" +/- .005"
3. Housing is soluble in chlorinated hydrocarbons and ketones. Methanol or isopropanol are recommended as a cleaning agent.

SCHEMATICS

KT 930/KT 940

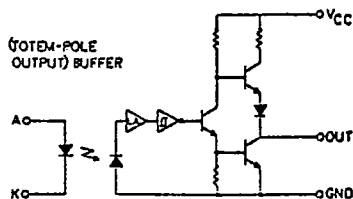

KT932/KT942

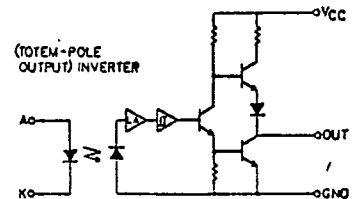

TYPICAL PERFORMANCE CURVES

T-41-73

KT930 / KT933 / KT940 / KT943

Output Current (High) vs Ambient Temperature

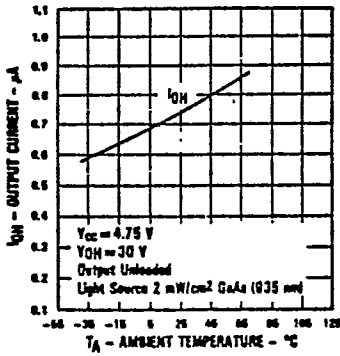

Rise Time and Fall Time vs Ambient Temperature

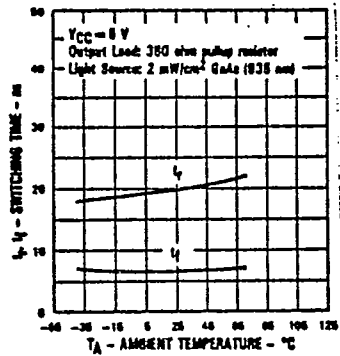

KT930 / KT931 / KT940 / KT941

Normalized Supply Current vs Ambient Temperature

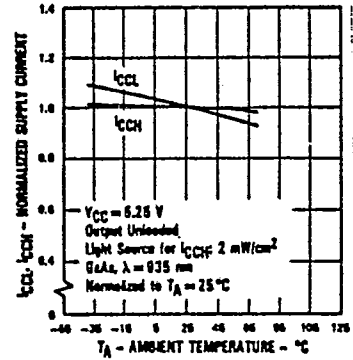

KT932/KT933/KT942/KT943

Normalized Supply Current vs Ambient Temperature

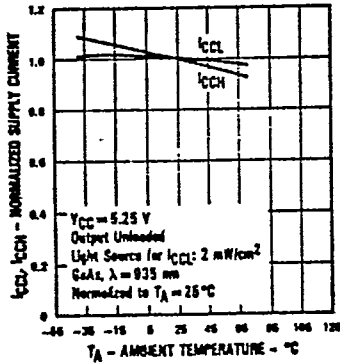

ALL ASSEMBLIES

Propagation Time vs Ambient Temperature

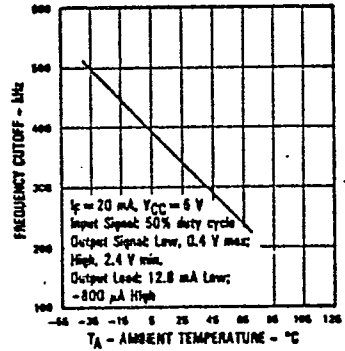
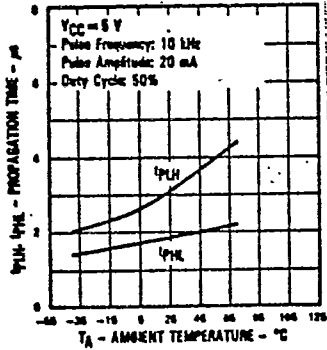

ALL ASSEMBLIES

Trigger Current vs Ambient Temperature

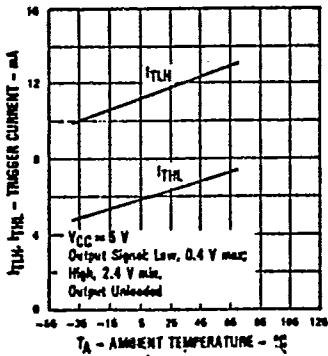

Switching Test Curve for Inverters

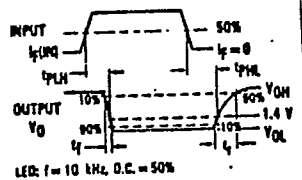

Switching Test Curve for Buffers

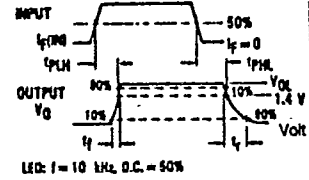

KT930/KT932/KT940/KT942

Output Voltage vs Ambient Temperature

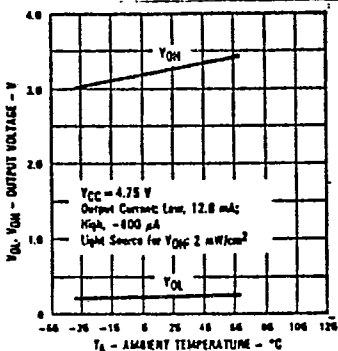

Short Circuit Output Current vs Ambient Temperature

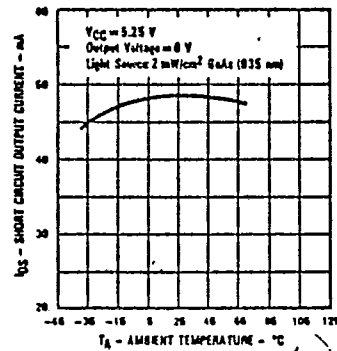

7