

## KA2211

## LINEAR INTEGRATED CIRCUIT

## 5.8W DUAL POWER AMPLIFIER

The KA2211 is a dual audio power amplifier for consumer application. It is designed for high power, low dissipation and low noise.

It also contains various kind of protectors. It is suitable for car-audio power amplifier with high performance.

## FEATURES

- Operating supply voltage range:  $V_{CC}=10V \sim 18V$
- High power (Dual)  
 $P_o = 5.8W$  (Typ) at  $V_{CC} = 13.2V$ ,  $R_L = 4\Omega$ , THD = 10%
- Low distortion (Dual)  
THD = 0.06% (Typ) at  $V_{CC} = 13.2V$ ,  $R_L = 4\Omega$ ,  $P_o = 1W$ ,  $A_v = 52dB$
- Low noise (Dual)  
 $V_{NO} = 0.7mV$  (Typ) at  $V_{CC} = 13.2V$ ,  $R_L = 4\Omega$ ,  $R_g = 10K\Omega$ ,  
 $A_v = 52dB$ ,  $BW(-3dB) = 20Hz \sim 20KHz$
- Protector; Thermal shut down  
Over voltage protection  
DC short protection

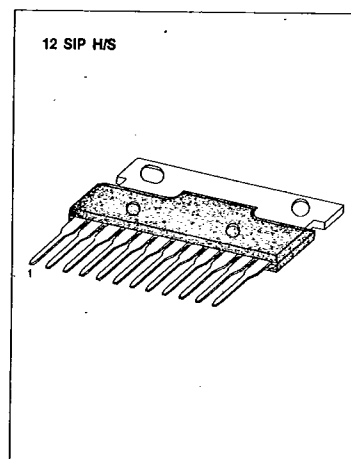

## BLOCK DIAGRAM

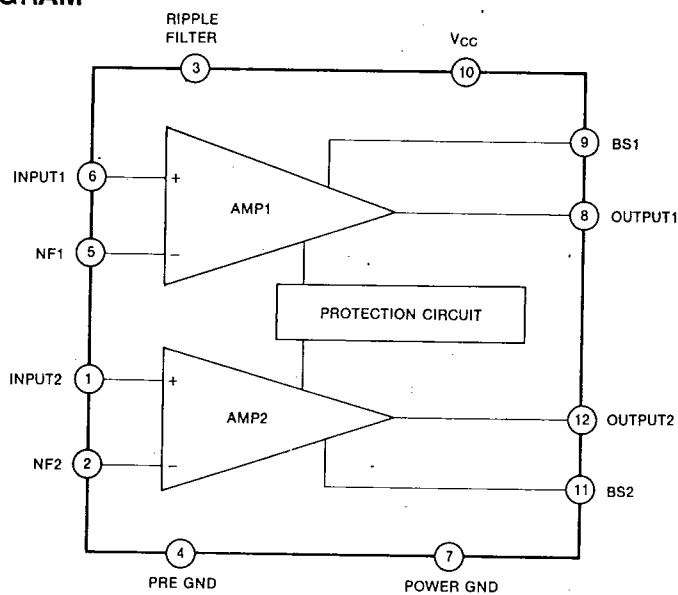

Fig. 1



SAMSUNG SEMICONDUCTOR

97

## KA2211

## LINEAR INTEGRATED CIRCUIT

ABSOLUTE MAXIMUM RATINGS ( $T_a = 25^\circ\text{C}$ )

Characteristic	Symbol	Condition	Value	Unit
Supply Voltage	$V_{CC}$ (surge)	$t = 0.2$ sec	45	V
Maximum Supply Voltage	$V_{CC}$ (max 1)	$V_i = 0$	25	V
Maximum Supply Voltage	$V_{CC}$ (max 2)	with signal	18	V
Maximum Output Current	$I_o$ (peak)		3.5	A
Power Dissipation	$P_d$		15	W
Operating Temperature	$T_{opr}$		-20 ~ +75	$^\circ\text{C}$
Storage Temperature	$T_{stg}$		-40 ~ +150	$^\circ\text{C}$

## ELECTRICAL CHARACTERISTICS

( $T_a = 25^\circ\text{C}$ ,  $V_{CC} = 13.2\text{V}$ ,  $R_L = 4\Omega$ ,  $R_o = 600\Omega$ ,  $f = 1\text{KHz}$ , unless otherwise specified)

Characteristic	Symbol	Test Conditions	Min	Typ	Max	Unit
Quiescent Circuit Current	$I_{CC}$	$V_i = 0$		80	145	mA
Output Power	$P_o$	THD = 10%	5	5.8		W
Total Harmonic Distortion	THD	$P_o = 1\text{W}$		0.06	0.3	%
Voltage Gain	$A_v$	$V_o = 0\text{dBm}$	50	52	54	dB
Channel Balance	CB	$V_o = 0\text{dBm}$	-1	0	1	dB
Output Noise Voltage	$V_{NO}$	$R_g = 10\text{K}\Omega$ , $BW(-3\text{dB}) = 20\text{Hz} \sim 20\text{KHz}$		0.7	1.5	mV
Ripple Rejection Ratio	RR	$f = 120\text{Hz}$ , $V_r = 0\text{dBm}$	40	52		dB
Cross Talk	CT	$V_o = 0\text{dBm}$		57		dB
Input Resistance	$R_i$	$f = 1\text{KHz}$		33		$\text{K}\Omega$

KA2211

LINEAR INTEGRATED CIRCUIT

TEST AND APPLICATION CIRCUIT

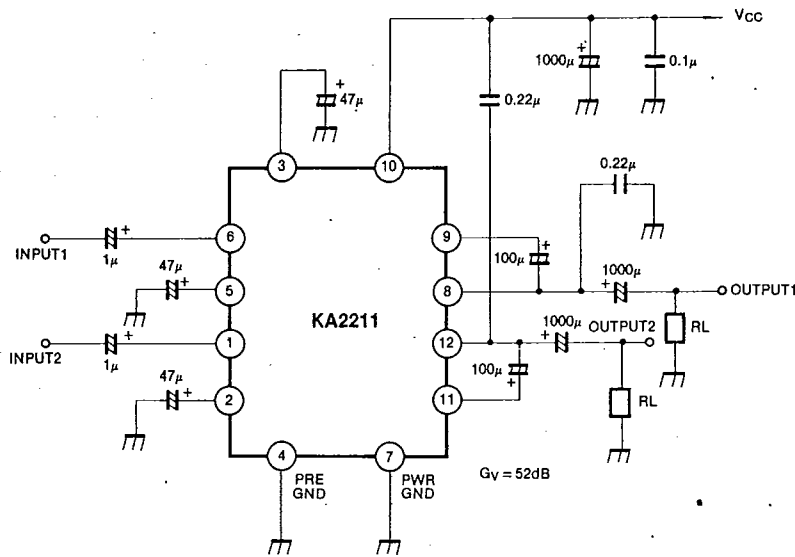
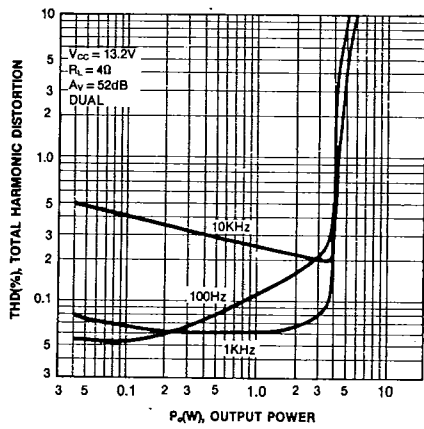
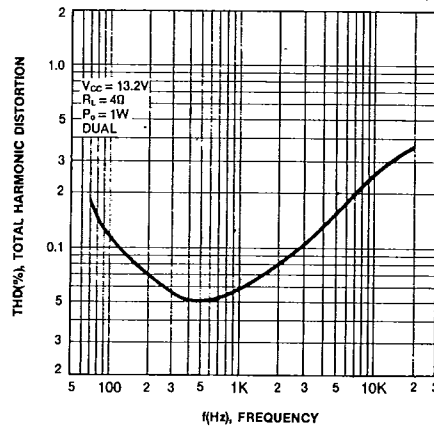

Fig. 2

TOTAL HARMONIC DISTORTION-OUTPUT POWER



TOTAL HARMONIC DISTORTION-FREQUENCY



T-74-05-01

KA2211

LINEAR INTEGRATED CIRCUIT

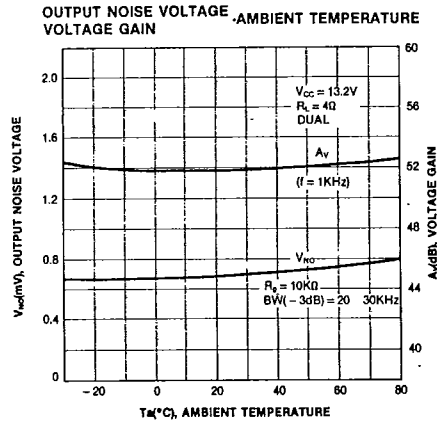
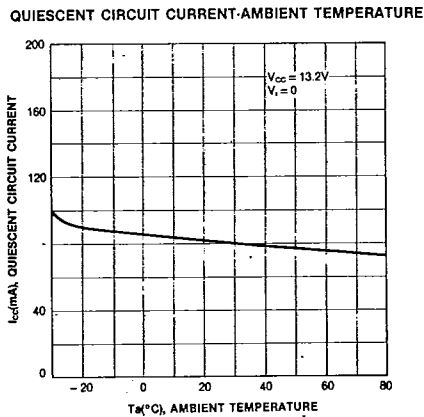
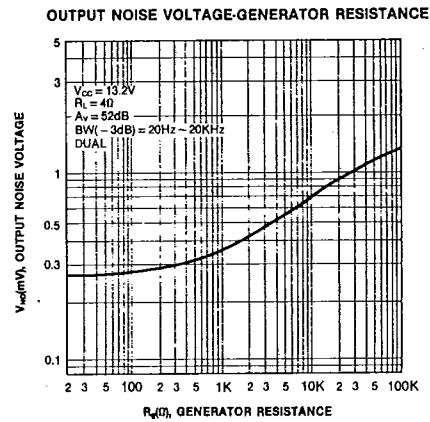
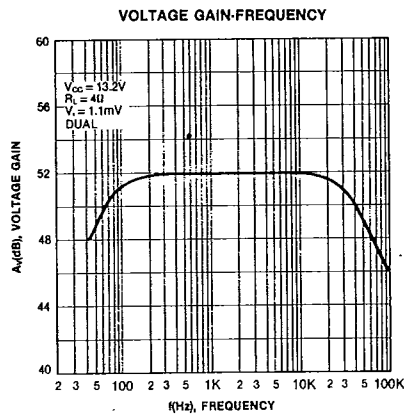
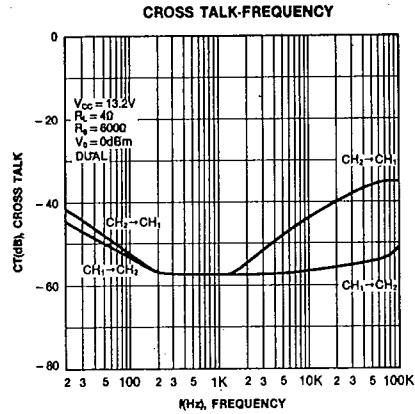
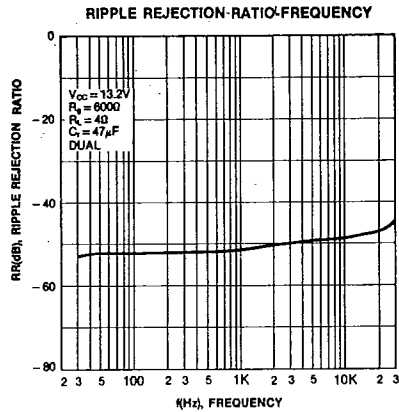

KA2211

LINEAR INTEGRATED CIRCUIT

QUIESCENT CIRCUIT CURRENT-SUPPLY VOLTAGE

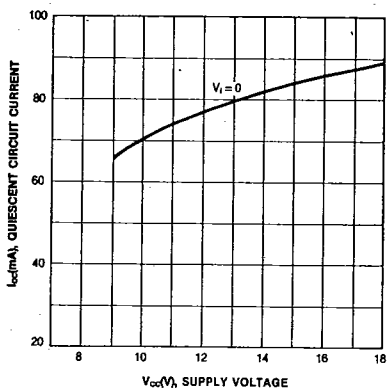

POWER DISSIPATION-SUPPLY VOLTAGE

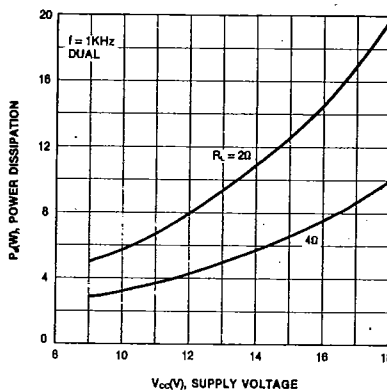

POWER DISSIPATION-OUTPUT POWER

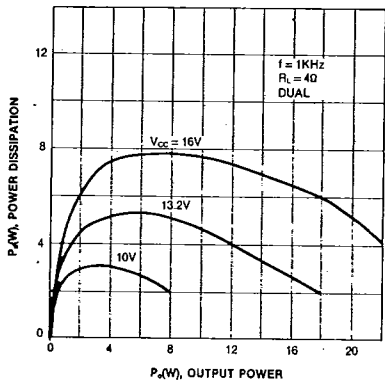

POWER DISSIPATION-OUTPUT POWER

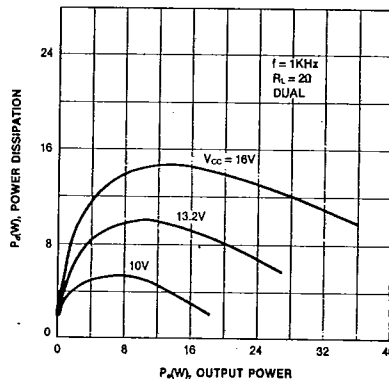

OUTPUT POWER-SUPPLY VOLTAGE

