

6 Channel EMI Filter Array with ESD Protection

Features

- Functionally and pin compatible with CSPEMI306A device
- *OptiGuard*[™] coated for improved reliability at assembly
- Six channels of EMI filtering for data ports
- Pi-style EMI filters in a capacitor-resistor-capacitor (C-R-C) network
- 40dB absolute attenuation (typical) at 1 GHz
- 35dB attenuation (typical) at 1 GHz relative to pass band
- ±15kV ESD protection on each channel (IEC 61000-4-2 Level 4, contact discharge)
- ±30kV ESD protection on each channel (HBM)
- 15-bump, 2.960mm X 1.330mm footprint
- Chip Scale Package (CSP)
- Chip Scale Package features extremely low lead inductance for optimum filter and ESD performance
- Lead-free version available

Applications

- EMI filtering and ESD protection for both data and I/O ports
- Wireless Handsets
- Handheld PCs / PDAs
- MP3 Players
- Notebooks
- Desktop PCs

Product Description

The CM1400-03 is a six channel low-pass filter array that reduces EMI/RFI emissions while at the same time providing ESD protection. It is used on data ports on mobile devices. To reduce EMI/RFI emissions, the CM1400-03 integrates a pi-style filter (C-R-C) for each of the 6 channels. Each high quality filter provides greater than 30dB attenuation in the 800-2700 MHz range relative to the pass band attenuation. These pi-style filters also support bidirectional filtering, controlling EMI both to and from a data port connector.

In addition, the CM1400-03 provides a very high level of protection for sensitive electronic components that may be subjected to electrostatic discharge (ESD). The input pins are designed and characterized to safely dissipate ESD strikes of ±15kV, exceeding the maximum requirement of the IEC 61000-4-2 international standard. Using the MIL-STD-883 (Method 3015) specification for Human Body Model (HBM) ESD, the device provides protection for contact discharges to greater than ±30kV.

The CM1400-03 is particularly well suited for portable electronics (e.g., cellular telephones, PDAs, notebook computers) because of its small package footprint and low weight.

The CM1400-03 incorporates *OptiGuard*[™] coating which results in improved reliability at assembly. The CM1400-03 is available in a space-saving, low-profile chip scale package with optional lead-free finishing.

Electrical Schematic

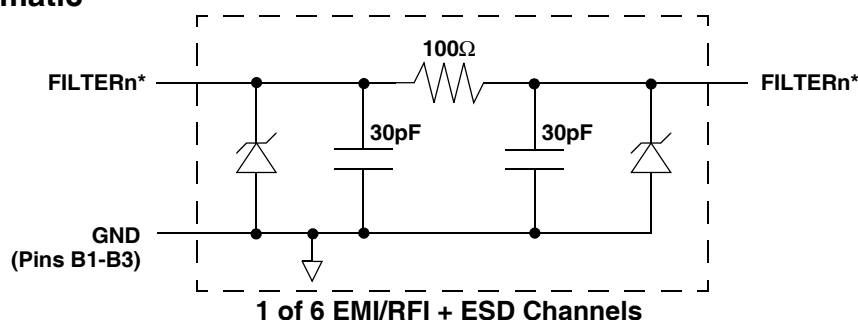

* See Package/Pinout Diagram for expanded pin information.

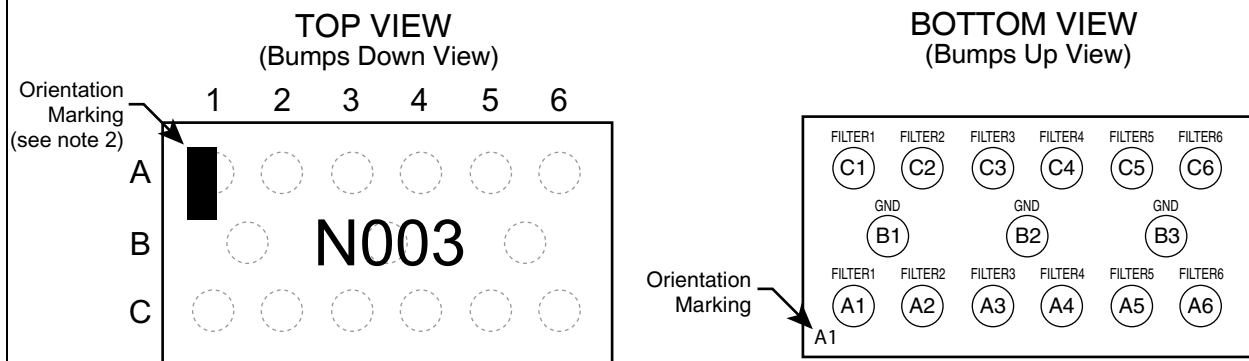
PACKAGE / PINOUT DIAGRAMS

CM1400-03CS/CP
CSP Package

Notes:

- 1) These drawings are not to scale.
- 2) Lead-free devices are specified by using a "+" character for the top side orientation mark.

PIN DESCRIPTIONS

| PIN(s) | NAME | DESCRIPTION |
|--------|---------|------------------|
| A1 | FILTER1 | Filter Channel 1 |
| A2 | FILTER2 | Filter Channel 2 |
| A3 | FILTER3 | Filter Channel 3 |
| A4 | FILTER4 | Filter Channel 4 |
| A5 | FILTER5 | Filter Channel 5 |
| A6 | FILTER6 | Filter Channel 6 |
| B1-B3 | GND | Device Ground |
| C1 | FILTER1 | Filter Channel 1 |
| C2 | FILTER2 | Filter Channel 2 |
| C3 | FILTER3 | Filter Channel 3 |
| C4 | FILTER4 | Filter Channel 4 |
| C5 | FILTER5 | Filter Channel 5 |
| C6 | FILTER6 | Filter Channel 6 |

Ordering Information
PART NUMBERING INFORMATION

| Pins | Package | Standard Finish | | Lead-free Finish ² | |
|------|---------|-----------------------------------|--------------|-----------------------------------|--------------|
| | | Ordering Part Number ¹ | Part Marking | Ordering Part Number ¹ | Part Marking |
| 15 | CSP | CM1400-03CS | N003 | CM1400-03CP | N003 |

Note 1: Parts are shipped in Tape & Reel form unless otherwise specified.

Note 2: Lead-free devices are specified by using a "+" character for the top side orientation mark.

Specifications

ABSOLUTE MAXIMUM RATINGS

| PARAMETER | RATING | UNITS |
|---------------------------|-------------|-------|
| Storage Temperature Range | -65 to +150 | °C |
| DC Power per Resistor | 100 | mW |
| DC Package Power Rating | 600 | mW |

STANDARD OPERATING CONDITIONS

| PARAMETER | RATING | UNITS |
|-----------------------------|------------|-------|
| Operating Temperature Range | -40 to +85 | °C |

ELECTRICAL OPERATING CHARACTERISTICS (SEE NOTE1)

| SYMBOL | PARAMETER | CONDITIONS | MIN | TYP | MAX | UNITS |
|--------------------|--|--------------------------|-------------|-------------|-------------|----------|
| R | Resistance | | 80 | 100 | 120 | Ω |
| C | Capacitance | At 2.5V DC | 24 | 30 | 36 | pF |
| TCR | Temperature Coefficient of Resistance | | | 1200 | | ppm/°C |
| TCC | Temperature Coefficient of Capacitance | At 2.5V DC | | -300 | | ppm/°C |
| V _{DIODE} | Diode Voltage (reverse bias) | I _{DIODE} =10μA | | 6.0 | | V |
| I _{LEAK} | Diode Leakage Current (reverse bias) | V _{DIODE} =3.3V | | | 100 | nA |
| V _{SIG} | Signal Voltage Positive Clamp Negative Clamp | I _{LOAD} = 10mA | 5.6 -1.5 | 6.8 -0.8 | 9.0 -0.4 | V V |
| V _{ESD} | In-system ESD Withstand Voltage a) Human Body Model, MIL-STD-883, Method 3015 b) Contact Discharge per IEC 61000-4-2 Level 4 | Notes 2 and 4 | ±30 ±15 | | | kV kV |
| V _{CL} | Clamping Voltage during ESD Discharge MIL-STD-883 (Method 3015), 8kV Positive Transients Negative Transients | Notes 2, 3 and 4 | | +10 -5 | | V V |
| f _C | Cut-off Frequency Z _{SOURCE} =50Ω, Z _{LOAD} =50Ω | R=100Ω, C=30pF | | 58 | | MHz |

Note 1: T_A=25°C unless otherwise specified.

Note 2: ESD applied to input and output pins with respect to GND, one at a time.

Note 3: Clamping voltage is measured at the opposite side of the EMI filter to the ESD pin. For example, if ESD is applied to Pin A1, then clamping voltage is measured at Pin C1.

Note 4: These parameters are guaranteed by design and characterization.

Performance Information

Typical Filter Performance (T_A=25°C, DC Bias=0V, 50 Ohm Environment)

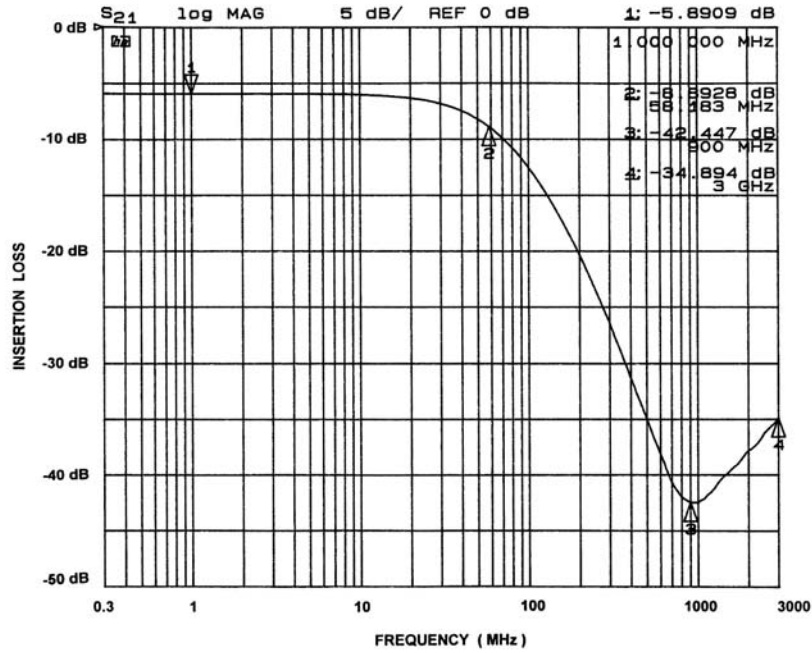

Figure 1. Insertion Loss vs. Frequency (A1-C1 to GND B2)

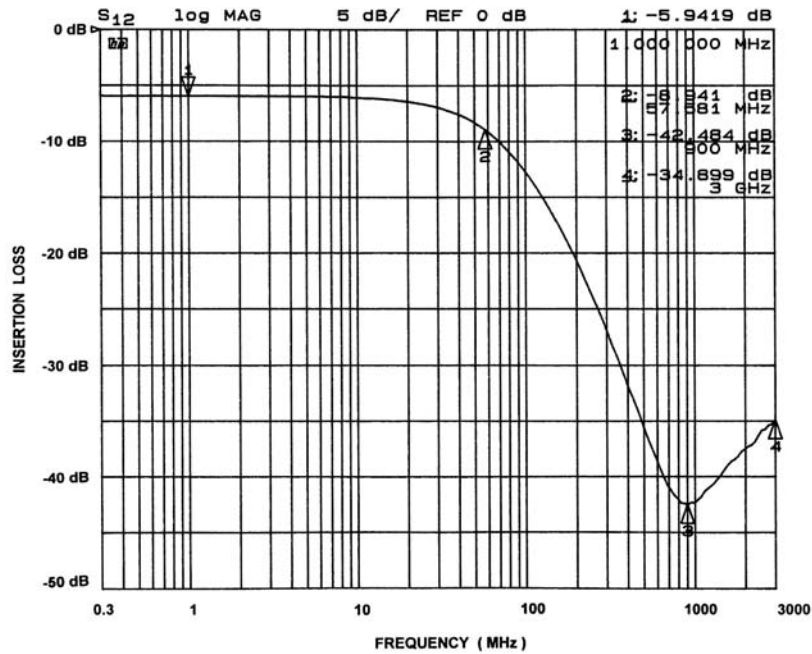

Figure 2. Insertion Loss vs. Frequency (A2-C2 to GND B2)

Performance Information (cont'd)

Typical Filter Performance ($T_A=25^\circ\text{C}$, DC Bias=0V, 50 Ohm Environment)

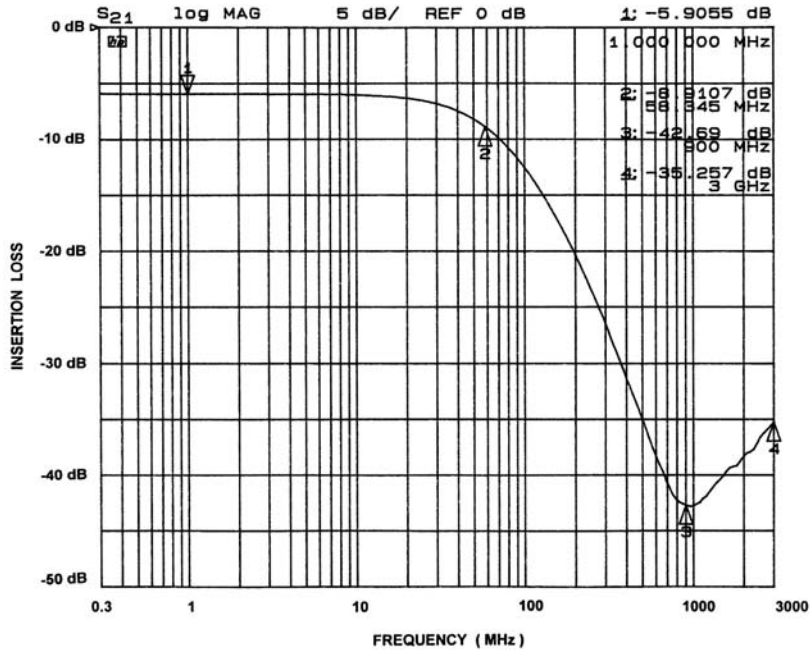

Figure 3. Insertion Loss vs. Frequency (A3-C3 to GND B2)

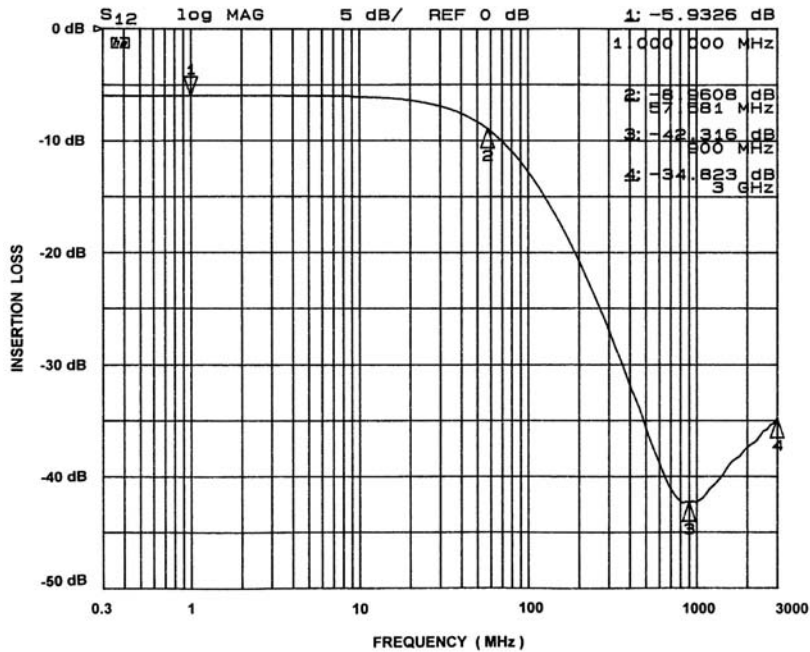

Figure 4. Insertion Loss vs. Frequency (A4-C4 to GND B2)

Performance Information (cont'd)

Typical Filter Performance ($T_A=25^\circ\text{C}$, DC Bias=0V, 50 Ohm Environment)

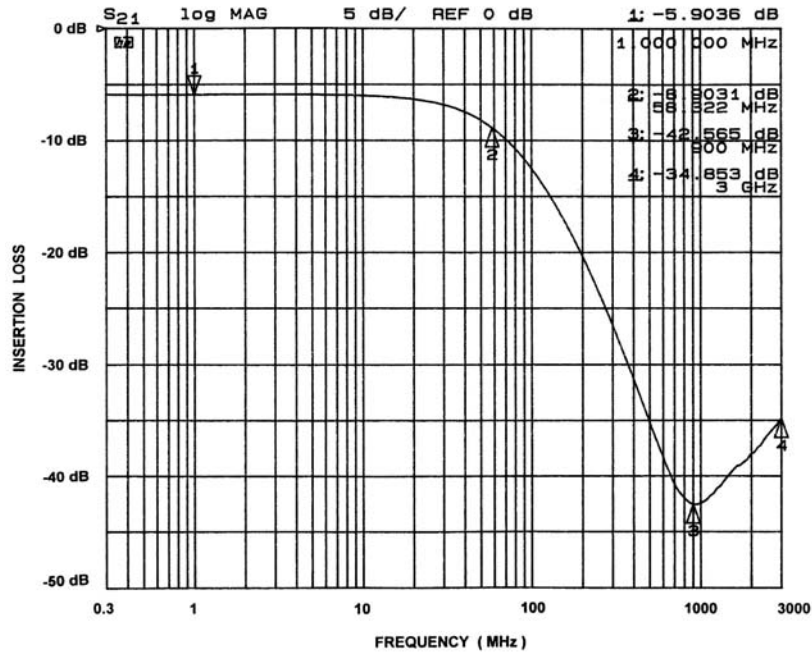

Figure 5. Insertion Loss vs. Frequency (A5-C5 to GND B2)

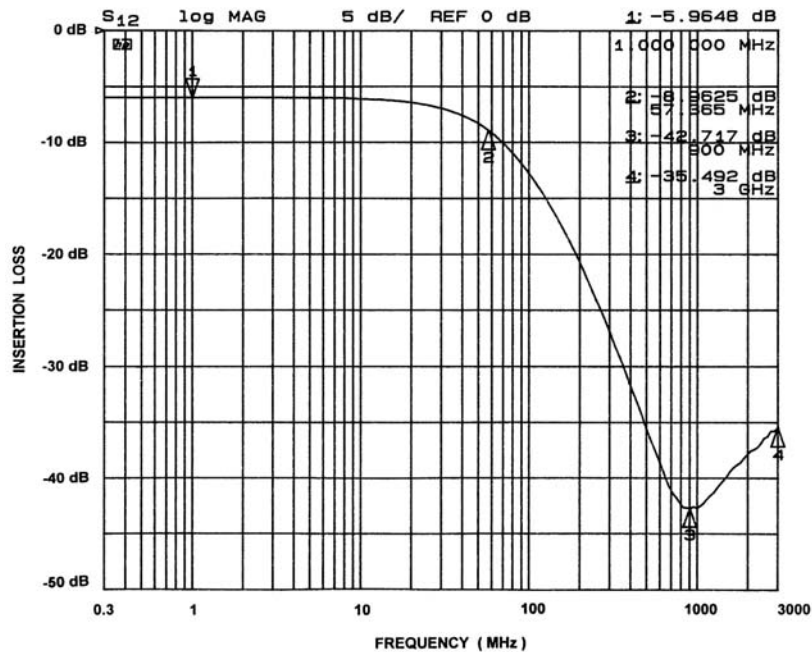

Figure 6. Insertion Loss vs. Frequency (A6-C6 to GND B2)

Performance Information (cont'd)

Typical Filter Performance ($T_A=25^\circ\text{C}$, DC Bias=0V, 50 Ohm Environment)

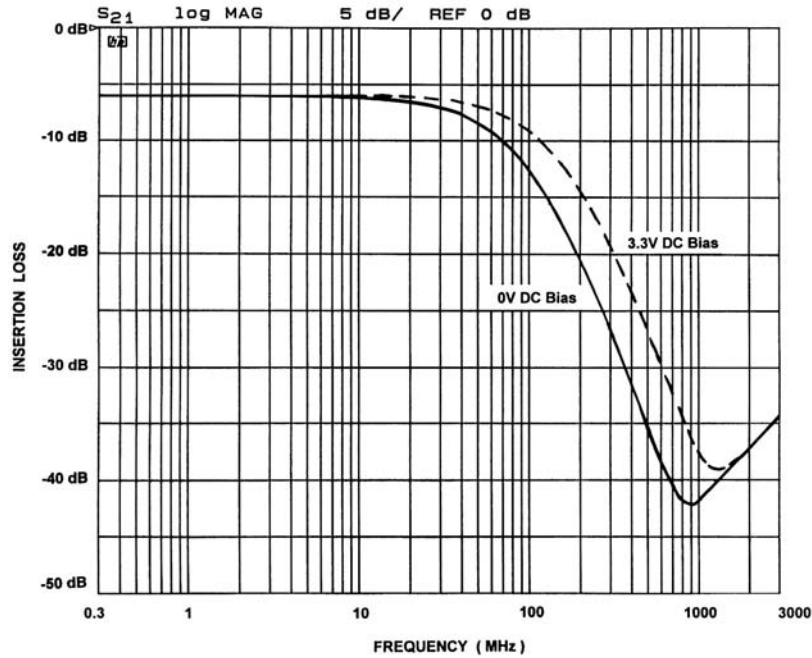

Figure 7. Comparison of Filter Response Curves for CM1400-03 with DC Bias

Performance Information (cont'd)

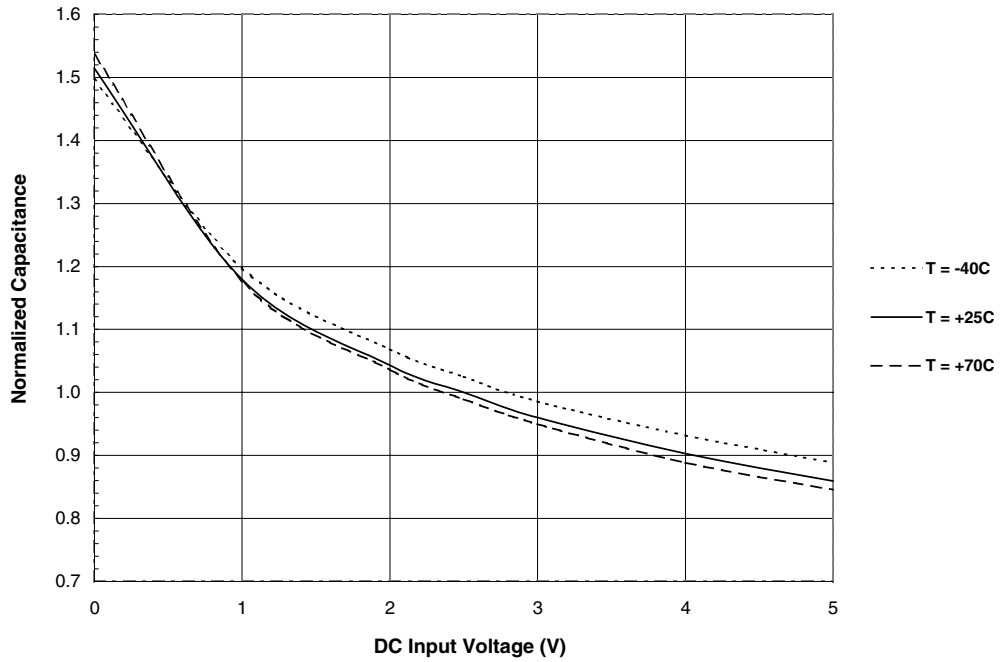

Figure 8. Filter Capacitance vs. Input Voltage over Temperature (normalized to capacitance at 2.5VDC and 25°C)

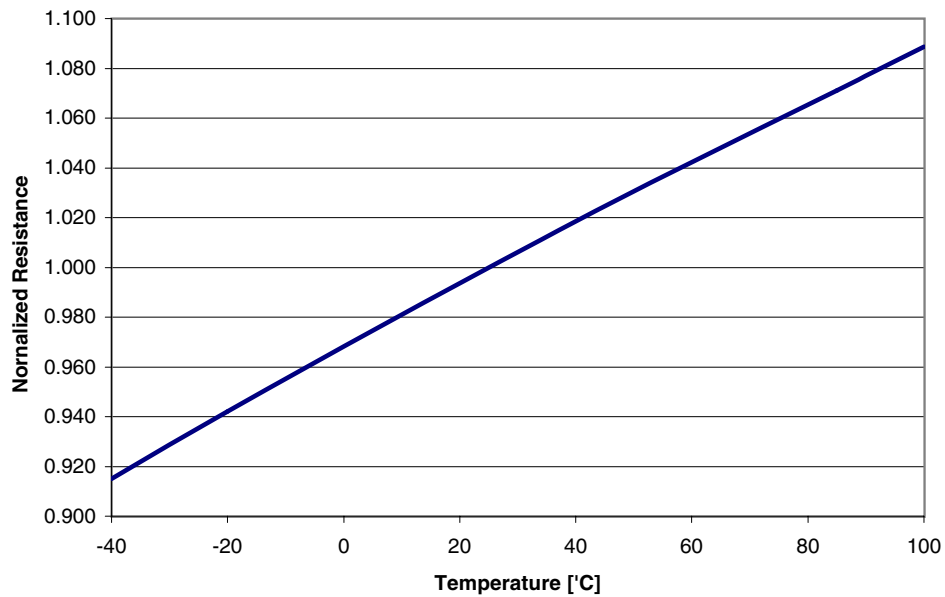

Figure 9. Resistance vs. Temperature (normalized to resistance at 25°C)

Application Information

Refer to Application Note AP-217, "The Chip Scale Package", for a detailed description of Chip Scale Packages offered by California Micro Devices.

PRINTED CIRCUIT BOARD RECOMMENDATIONS

| PARAMETER | VALUE |
|--|------------------------------|
| Pad Size on PCB | 0.275mm |
| Pad Shape | Round |
| Pad Definition | Non-Solder Mask defined pads |
| Solder Mask Opening | 0.325mm Round |
| Solder Stencil Thickness | 0.125mm - 0.150mm |
| Solder Stencil Aperture Opening (laser cut, 5% tapered walls) | 0.330mm Round |
| Solder Flux Ratio | 50/50 by volume |
| Solder Paste Type | No Clean |
| Pad Protective Finish | OSP (Entek Cu Plus 106A) |
| Tolerance — Edge To Corner Ball | $\pm 50\mu\text{m}$ |
| Solder Ball Side Coplanarity | $\pm 20\mu\text{m}$ |
| Maximum Dwell Time Above Liquidous | 60 seconds |
| Maximum Soldering Temperature for Eutectic Devices using a Eutectic Solder Paste | 240°C |
| Maximum Soldering Temperature for Lead-free Devices using a Lead-free Solder Paste | 260°C |

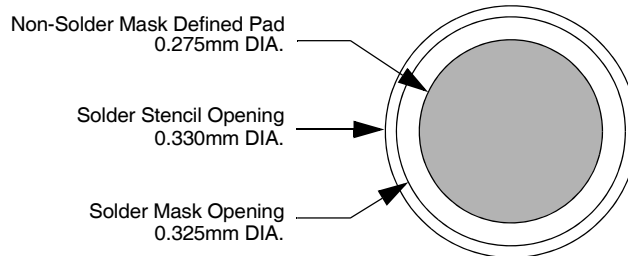

Figure 10. Recommended Non-Solder Mask Defined Pad Illustration

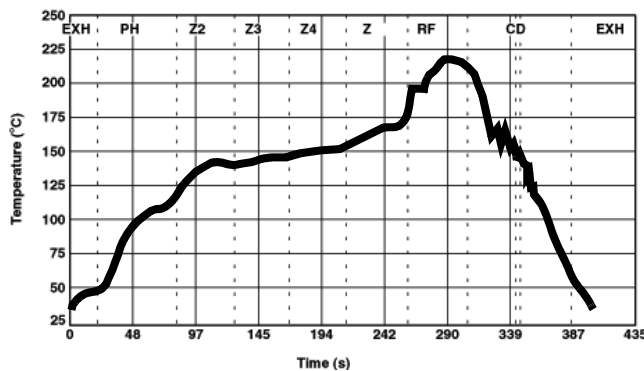

Figure 11. Eutectic (SnPb) Solder Ball Reflow Profile

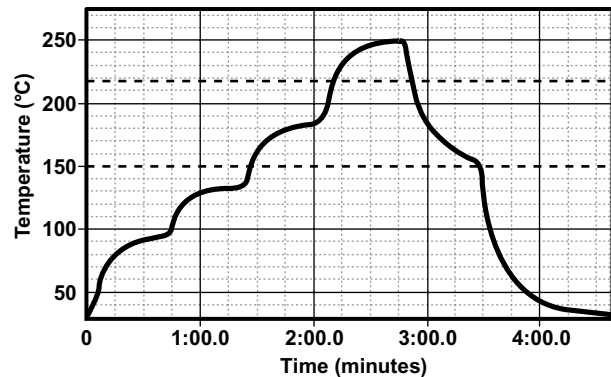

Figure 12. Lead-free (SnAgCu) Solder Ball Reflow Profile

Mechanical Details

CSP Mechanical Specifications

The CM1400-03 is supplied in a custom Chip Scale Package (CSP). Dimensions are presented below. For complete information on the CSP, see the California Micro Devices CSP Package Information document.

| PACKAGE DIMENSIONS | | | | | | |
|------------------------------------|-------------|-------|-------|--------|--------|--------|
| Package | Custom CSP | | | | | |
| Bumps | 15 | | | | | |
| Dim | Millimeters | | | Inches | | |
| | Min | Nom | Max | Min | Nom | Max |
| A1 | 2.915 | 2.960 | 3.005 | 0.1148 | 0.1165 | 0.1183 |
| A2 | 1.285 | 1.330 | 1.375 | 0.0506 | 0.0524 | 0.0541 |
| B1 | 0.495 | 0.500 | 0.505 | 0.0195 | 0.0197 | 0.0199 |
| B2 | 0.245 | 0.250 | 0.255 | 0.0096 | 0.0098 | 0.0100 |
| B3 | 0.430 | 0.435 | 0.440 | 0.0169 | 0.0171 | 0.0173 |
| B4 | 0.430 | 0.435 | 0.440 | 0.0169 | 0.0171 | 0.0173 |
| C1 | 0.180 | 0.230 | 0.280 | 0.0071 | 0.0091 | 0.0110 |
| C2 | 0.180 | 0.230 | 0.280 | 0.0071 | 0.0091 | 0.0110 |
| D1 | 0.575 | 0.644 | 0.714 | 0.0226 | 0.0254 | 0.0281 |
| D2 | 0.368 | 0.419 | 0.470 | 0.0145 | 0.0165 | 0.0185 |
| # per tape and reel | 3500 pieces | | | | | |
| Controlling dimension: millimeters | | | | | | |

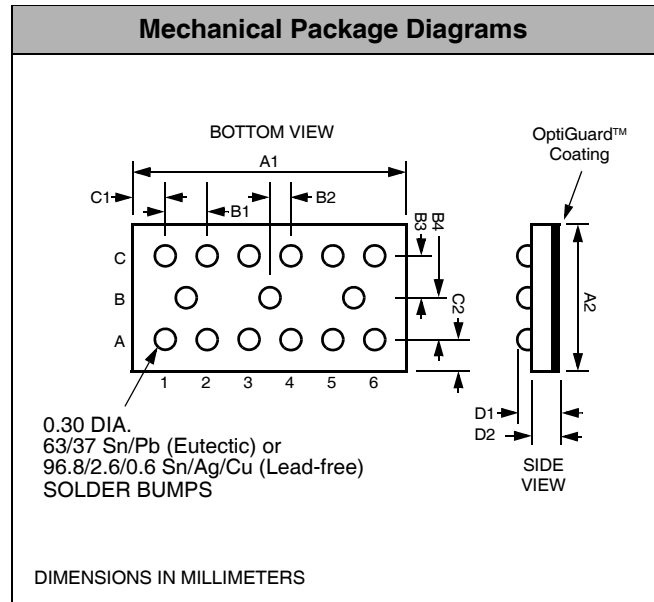

Package Dimensions for CM1400-03 Chip Scale Package

CSP Tape and Reel Specifications

| PART NUMBER | CHIP SIZE (mm) | POCKET SIZE (mm) $B_0 \times A_0 \times K_0$ | TAPE WIDTH W | REEL DIAMETER | QTY PER REEL | P_0 | P_1 |
|-------------|---------------------|---|-----------------|---------------|--------------|-------|-------|
| CM1400-03 | 2.96 X 1.33 X 0.644 | 3.10 X 1.45 X 0.74 | 8mm | 178mm (7") | 3500 | 4mm | 4mm |

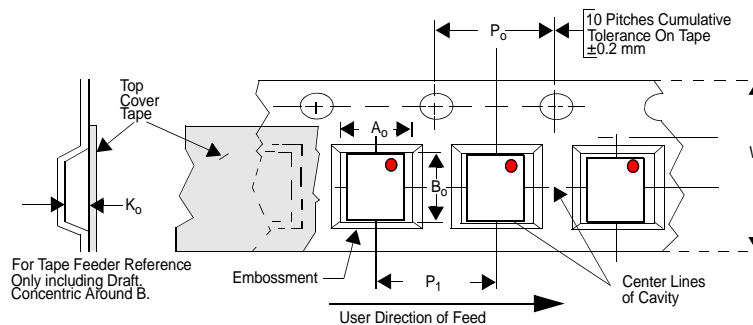

Figure 13. Tape and Reel Mechanical Data