

LOW LOSS SUPER HIGH SPEED RECTIFIER

Outline drawings, mm

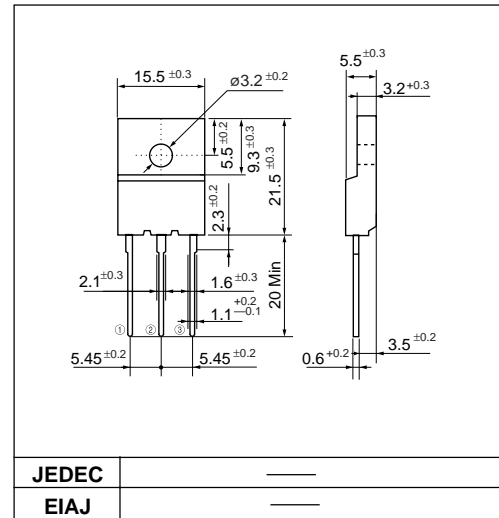

Features

- Insulated package by fully molding
- Low V_F
- Super high speed switching
- High reliability by planer design

Applications

- High speed power switching

Maximum ratings and characteristics

- Absolute maximum ratings

Item	Symbol	Conditions	Rating	Unit
Repetitive peak reverse voltage	V_{RRM}		400	V
Average output current	I_o	Rectangle wave, duty=1/2, $T_c=93^\circ\text{C}$	20*	A
Surge current	I_{FSM}	Sine wave 10ms	80	A
Operating junction temperature	T_j		-40 to +150	$^\circ\text{C}$
Storage temperature	T_{stg}		-40 to +150	$^\circ\text{C}$

*Average forward current of centertap full wave connection

- Electrical characteristics ($T_a=25^\circ\text{C}$ Unless otherwise specified)

Item	Symbol	Conditions	Max.	Unit
Forward voltage drop	V_{FM}	$I_{FM}=10\text{A}$	1.5	V
Reverse current	I_{RRM}	$V_R=V_{RRM}$	500	μA
Reverse recovery time	t_{rr}	$I_F=0.1\text{A}$, $I_R=0.2\text{A}$	50	ns
Thermal resistance	$R_{th(j-c)}$	Junction to case	2.0*	$^\circ\text{C/W}$

Connection diagram

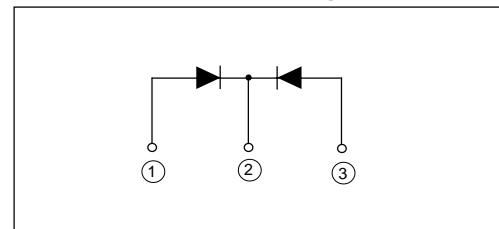

■ Characteristics

Forward characteristics

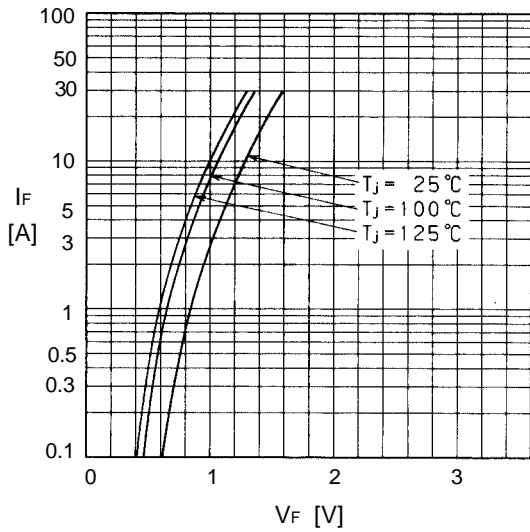

Reverse characteristics

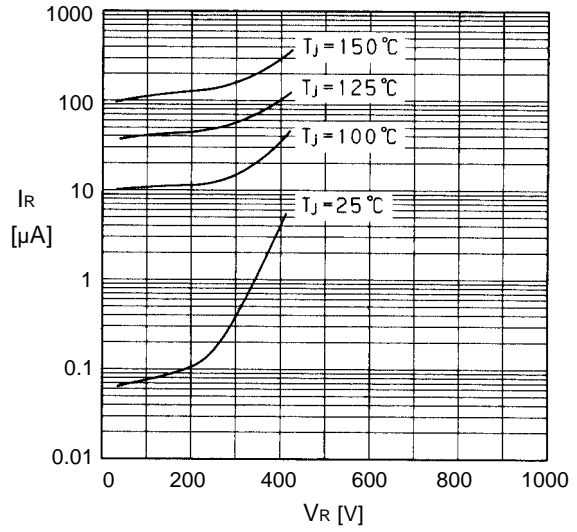

Forward power dissipation

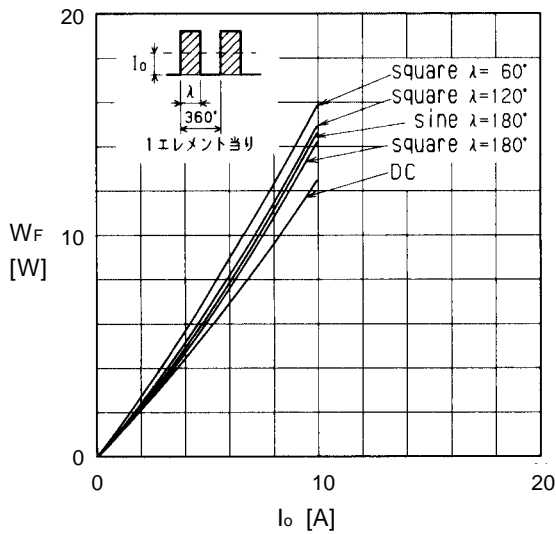

Reverse power dissipation

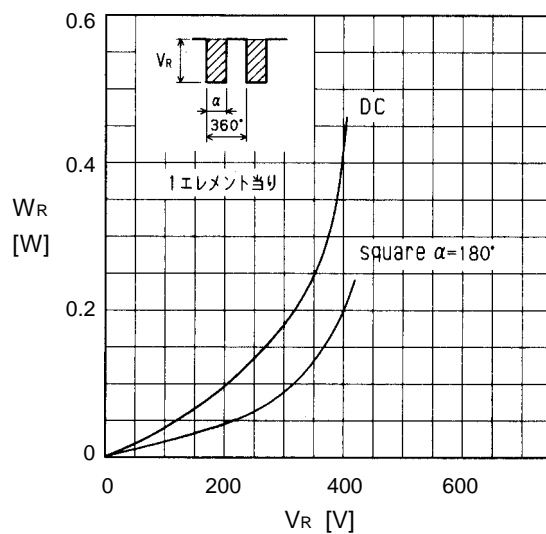

Output current-case temperature

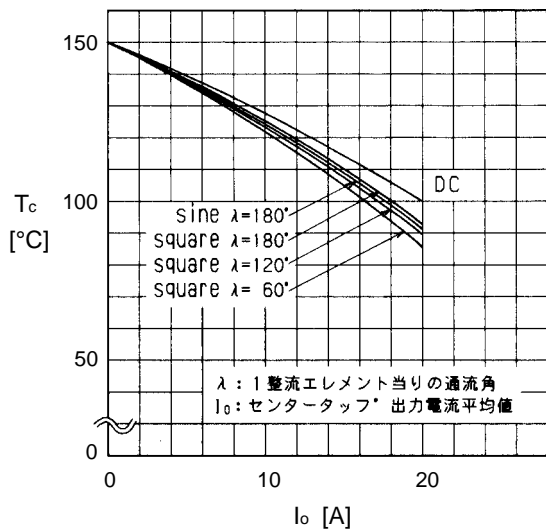

Junction capacitance characteristics

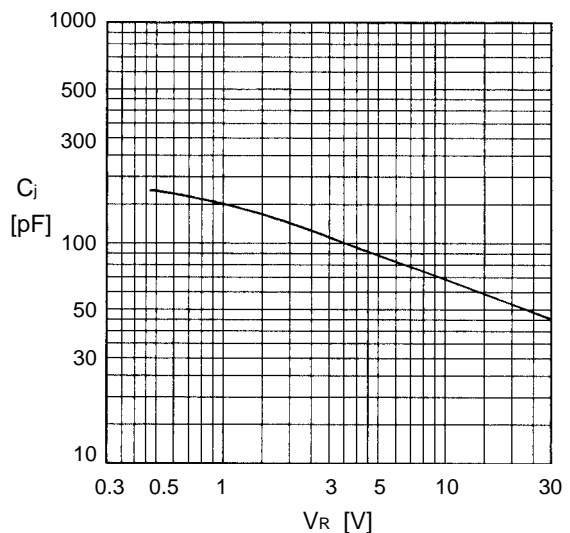

Surge capability

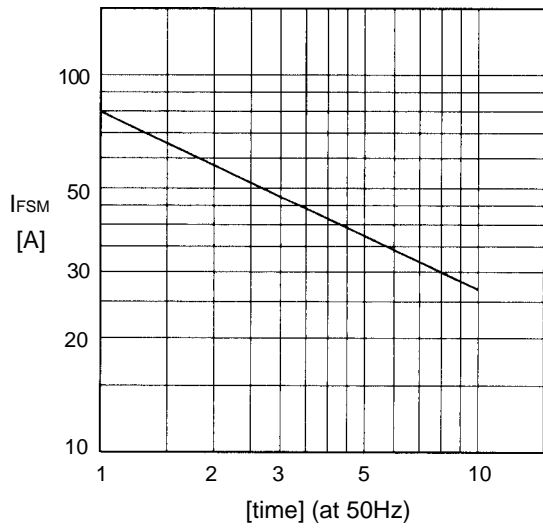

Transient thermal impedance

