

Features

1. High sensitivity.
2. TTL and LSTTL compatible output.
3. Operating supply voltage range.
(Vcc 4.5V to 17V)
4. Output form pull-up resistor built-in type.
5. Low output current dissipation.
(ICCL:MAX. 3.8mA)
6. High isolation voltage between input and output
(Viso:5000Vrms).
7. Available package : DIP/ SMD/ H. (For Package Dimension please refer to page 82)

Applications

1. Computer terminals.
2. High speed line receivers.
3. Interfaces with various data transmission equipment.
4. Switching regulators.

Outside Dimension : Unit (mm)

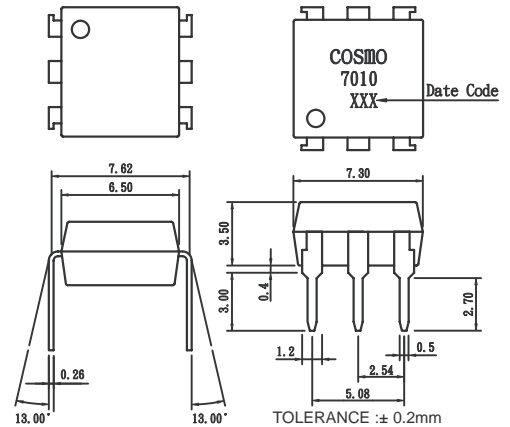

Schematic : Top View

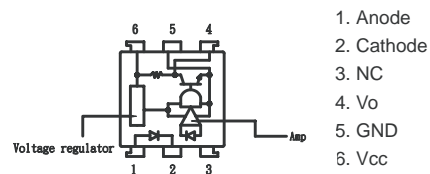

Absolute Maximum Ratings

(Ta=25°C)

Parameter		Symbol	Rating	Unit
Input	Forward current	IF	10	mA
	Peak forward current	IFM	1	V
	Reverse voltage	VR	6	V
	Power dissipation	PD	70	mW
Output	Supply voltage	VCC	-0.5 to 17	V
	Output current	IO	50	mA
	Power dissipation	PD	150	mW
Total power dissipation		Ptot	170	mW
Isolation voltage 1 minute		Viso	5000	Vrms
Operating temperature		Topr	-25 to +85	°C
Storage temperature		Tstg	-40 to +125	°C
Soldering temperature		Tsol	260	°C

Electro-optical Characteristics

(Ta=25°C)

Parameter		Symbol	Conditions	MIN.	TYP.	MAX.	Unit	
Input	Forward voltage	VF	IF =10mA	—	1.2	1.4	V	
	Peak forward voltage	VFM	IFM =0.5A	—	—	3.5	V	
	Reverse current	IR	VR =4V	—	—	10	uA	
	Terminal capacitance	Ct	V=0, f=1kHz	—	30	—	pF	
Output	Operating supply voltage	VCC		4.5	—	17	V	
	Low level output voltage	VOL	IOL =16mA, VCC =5V, IF =0	—	0.15	0.4	V	
	High level output voltage	VOH	VCC =5V, IF =4mA	3.5	—	—	V	
	Low level supply current	ICCL	VCC =5V, IF =0	—	1.7	3.8	mA	
	High level supply current	ICCH	VCC =5V, IF =1mA	—	0.7	2.2	mA	
Transfer characteristics	"High-Low" Threshold input current	IFHL	VCC =5V, RL =280ohm	0.1	0.4	—	mA	
	" Low-High " Threshold input current	IFLH	VCC =5V, RL =280ohm	—	0.5	1.0	mA	
	Hysteresis	IFHL /IFLH	VCC =5V, RL =280ohm	—	0.8	—	—	
	Isolation resistance	Riso	Ta =25°C, DC500V	5x10 ¹⁰	10 ¹¹	—	ohm	
	Response time	"High-Low" propagation delay time	tPHL	Ta=25°C, VCC=5V, IF =1mA, RL =280ohm	—	5	15	us
		" Low -High " propagation delay time	tPLH		—	3	9	
		Fall time	tf		—	0.05	0.5	
Rise time		tr	—		0.1	0.5		

Fig.1 Low Level Output Current vs. Ambient Temperature

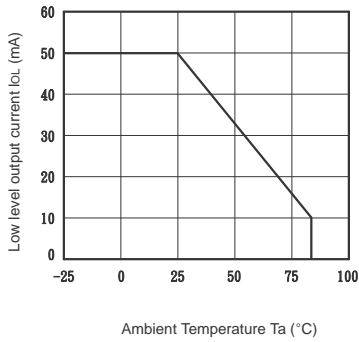

Fig.2 Power Dissipation vs. Ambient Temperature

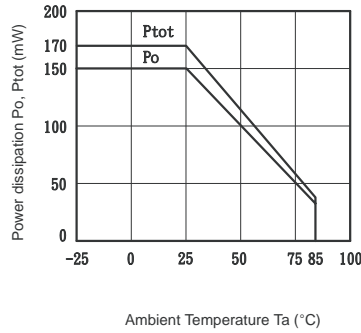

Fig.3 Rise Time, Fall Time vs. Load Resistance

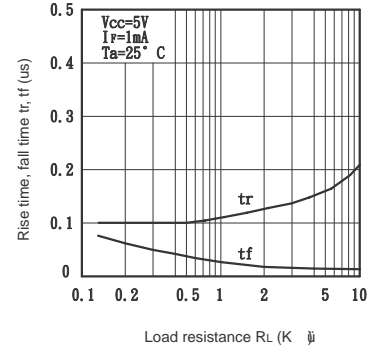

Fig.4 Forward Current vs. Forward Voltage

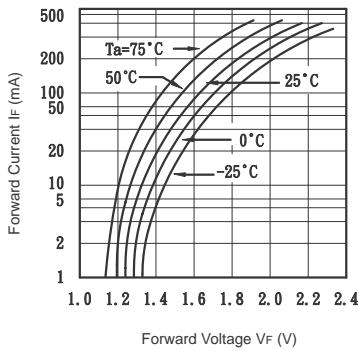

Fig.5 Supply Current vs. Ambient Temperature

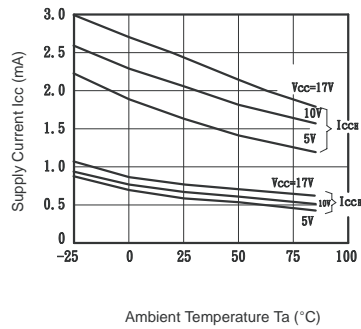

Fig.6 Low Level Output Voltage vs. Ambient Temperature

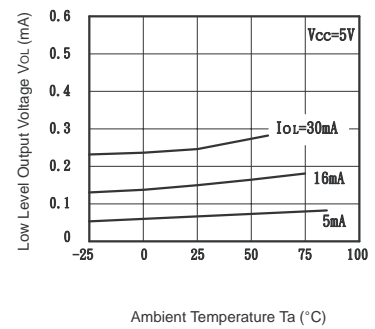

Fig.7 Propagation Delay Time vs. Forward Current

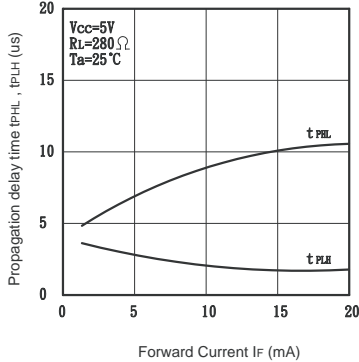

Fig.8 Low Level Output Voltage vs. Low Level Output Current

