

HIGH FIDELITY HEADPHONE AMPLIFIER

FEATURES

- 80 mW into 600 Ω From a ±12-V Supply at 0.00014% THD + N
- Current-Feedback Architecture
- Greater than 120 dB of Dynamic Range
- SNR of 120 dB
- Output Voltage Noise of 5 μVrms at Gain = 2 V/V
- Power Supply Range: ±5 V to ±15 V
- 1300 V/μs Slew Rate
- Differential Inputs
- Independent Power Supplies for Low Crosstalk
- Short Circuit and Thermal Protection

APPLICATIONS

- Professional Audio Equipment
- Mixing Boards
- Headphone Distribution Amplifiers
- Headphone Drivers
- Microphone Preamplifiers

DESCRIPTION

The TPA6120A2 is a high fidelity audio amplifier built on a current-feedback architecture. This high bandwidth, extremely low noise device is ideal for high performance equipment. The better than 120 dB of dynamic range exceeds the capabilities of the human ear, ensuring that nothing audible is lost due to the amplifier. The solid design and performance of the TPA6120A2 ensures that music, not the amplifier, is heard.

Three key features make current-feedback amplifiers outstanding for audio. The first feature is the high slew rate that prevents odd order distortion anomalies. The second feature is current-on-demand at the output that enables the amplifier to respond quickly and linearly when necessary without risk of output distortion. When large amounts of output power are suddenly needed, the amplifier can respond extremely quickly without raising the noise floor of the system and degrading the signal-to-noise ratio. The third feature is the gain-independent frequency response that allows the full bandwidth of the amplifier to be used over a wide range of gain settings. The excess loop gain does not deteriorate at a rate of 20 dB/decade.

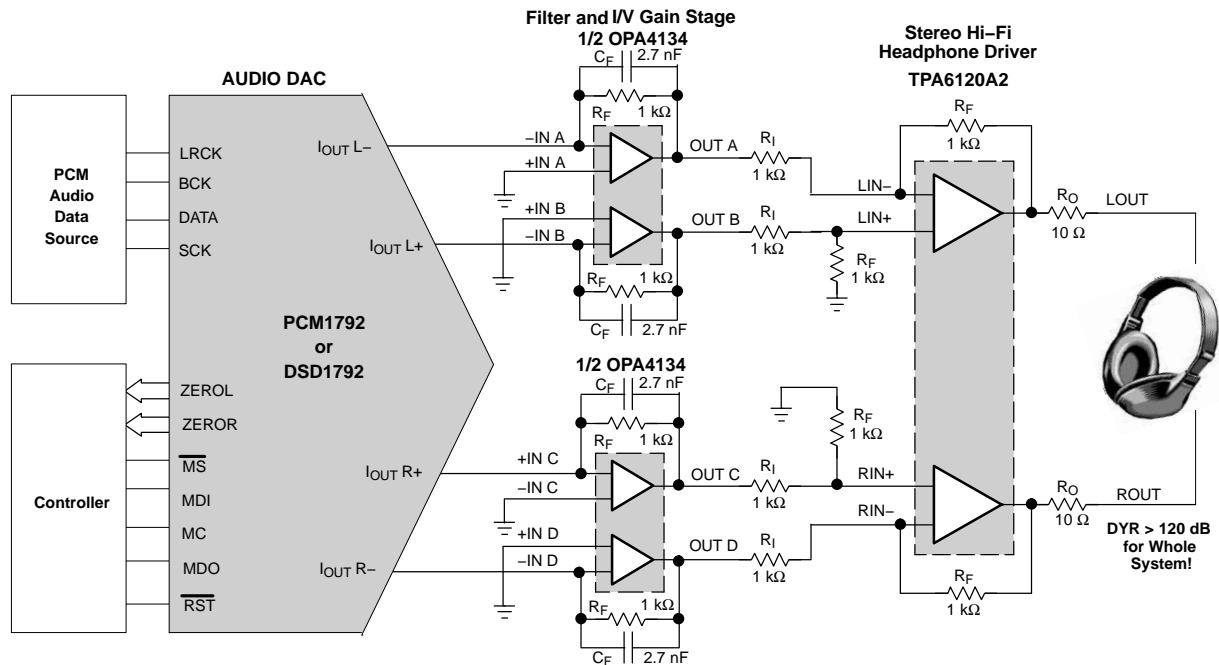

Please be aware that an important notice concerning availability, standard warranty, and use in critical applications of Texas Instruments semiconductor products and disclaimers thereto appears at the end of this data sheet.

PowerPAD is a trademark of Texas Instruments.



These devices have limited built-in ESD protection. The leads should be shorted together or the device placed in conductive foam during storage or handling to prevent electrostatic damage.

ABSOLUTE MAXIMUM RATINGS

over operating free-air temperature range (unless otherwise noted) ⁽¹⁾

	TPA6120A2
Supply voltage, V_{CC+} to V_{CC-}	33 V
Input voltage, V_I ⁽²⁾	$\pm V_{CC}$
Differential input voltage, V_{ID}	6 V
Minimum load impedance	8 Ω
Continuous total power dissipation	See Dissipation Rating Table
Operating free-air temperature range, T_A	- 40°C to 85°C
Operating junction temperature range, T_J ⁽³⁾	- 40°C to 150°C
Storage temperature range, T_{stg}	- 40°C to 125°C
Lead temperature 1,6 mm (1/16 inch) from case for 10 seconds	235°C

- (1) Stresses beyond those listed under “absolute maximum ratings” may cause permanent damage to the device. These are stress ratings only, and functional operation of the device at these or any other conditions beyond those indicated under “recommended operating conditions” is not implied. Exposure to absolute–maximum–rated conditions for extended periods may affect device reliability.
- (2) When the TPA6120A2 is powered down, the input source voltage must be kept below 600-mV peak.
- (3) The TPA6120A2 incorporates an exposed PowerPAD on the underside of the chip. This acts as a heatsink and must be connected to a thermally dissipating plane for proper power dissipation. Failure to do so may result in exceeding the maximum junction temperature that could permanently damage the device. See TI Technical Brief SLMA002 for more information about utilizing the PowerPAD thermally enhanced package.

DISSIPATION RATING TABLE

PACKAGE	θ_{JA} ⁽¹⁾ (°C/W)	θ_{JC} (°C/W)	$T_A = 25^\circ\text{C}$ POWER RATING
DWP	44.4	33.8	2.8 W

- (1) The PowerPAD must be soldered to a thermal land on the printed-circuit board. See the PowerPAD Thermally Enhanced Package application note (SLMA002)

AVAILABLE OPTIONS

T_A	PACKAGE	PART NUMBER	SYMBOL
-40°C to 85°C	DWP ⁽¹⁾	TPA6120A2DWP	6120A2

- (1) The DWP package is available taped and reeled. To order a taped and reeled part, add the suffix R to the part number (e.g., TPA6120A2DWPR).

RECOMMENDED OPERATING CONDITIONS

		MIN	MAX	UNIT
Supply voltage, V_{CC+} and V_{CC-}	Split Supply	± 5	± 15	V
	Single Supply	10	30	
Load impedance	$V_{CC} = \pm 5 \text{ V or } \pm 15 \text{ V}$	16		Ω
Operating free-air temperature, T_A		-40	85	°C

ELECTRICAL CHARACTERISTICS

over operating free-air temperature range (unless otherwise noted)

PARAMETER		TEST CONDITIONS	MIN	TYP	MAX	UNIT
$ V_{IO} $	Input offset voltage (measured differentially)	$V_{CC} = \pm 5\text{ V}$ or $\pm 15\text{ V}$		2	5	mV
PSRR	Power supply rejection ratio	$V_{CC} = 2.5\text{ V}$ to 5.5 V		75		dB
V_{IC}	Common mode input voltage	$V_{CC} = \pm 5\text{ V}$	± 3.6	± 3.7		V
		$V_{CC} = \pm 15\text{ V}$	± 13.4	± 13.5		
I_{CC}	Supply current (each channel)	$V_{CC} = \pm 5\text{ V}$		11.5	13	mA
		$V_{CC} = \pm 15\text{ V}$			15	
I_O	Output current (per channel)	$V_{CC} = \pm 5\text{ V}$ to $\pm 15\text{ V}$		700		mA
	Input offset voltage drift	$V_{CC} = \pm 5\text{ V}$ or $\pm 15\text{ V}$		20		$\mu\text{V}/^\circ\text{C}$
r_i	Input resistance			300		k Ω
r_o	Output resistance	Open Loop		13		Ω
V_O	Output voltage swing	$V_{CC} = \pm 15\text{ V}$, $R_L = 25\ \Omega$	11.8 to -11.5	12.5 to -12.2		V

OPERATING CHARACTERISTICS⁽¹⁾

T_A = 25°C, R_L = 25 Ω, Gain = 2 V/V (unless otherwise noted)

PARAMETER		TEST CONDITIONS	MIN	TYP	MAX	UNIT
IMD	Intermodulation distortion (SMPTE)	SMTPE ratio = 4:1, Gain = 2 V/V, IM frequency = 60 Hz High frequency = 7 kHz	V _{CC} = ±12 V to ±15 V, R _L = 32 Ω, V _I = 1 V _{PP}	0.00014%		
			V _{CC} = ±12 V to ±15 V, R _L = 64 Ω, V _I = 1 V _{PP}	0.000095%		
THD+N	Total harmonic distortion plus noise	P _O = 100 mW, R _L = 32 Ω f = 1 kHz	V _{CC} = ±12 V	0.00055%		
			V _{CC} = ±15 V	0.00060%		
		P _O = 100 mW, R _L = 64 Ω f = 1 kHz	V _{CC} = ±12 V	0.00038%		
			V _{CC} = ±15 V	0.00029%		
		V _{CC} = ±12 V, Gain = 3 V/V R _L = 600 Ω, f = 1 kHz	P _O = 80 mW	0.00014%		
			P _O = 40 mW	0.000065%		
V _{CC} = ±15 V, Gain = 3 V/V R _L = 600 Ω, f = 1 kHz	P _O = 125 mW	0.00012%				
	P _O = 62.5 mW	0.000061%				
	V _{CC} = ±12 V, Gain = 3 V/V	V _O = 15 V _{PP} , R _L = 10 kΩ f = 1 kHz	0.000024%			
		V _{CC} = ±15 V, Gain = 3 V/V	0.000021%			
k _{SVR}	Supply voltage rejection ratio	R _L = 32 Ω f = 10 Hz to 22 kHz V _(RIPPLE) = 1 V _{PP}	V _{CC} = ±12 V	-80		dB
			V _{CC} = ±15 V	-83		
		R _L = 64 Ω f = 10 Hz to 22 kHz V _(RIPPLE) = 1 V _{PP}	V _{CC} = ±12 V	-76		
			V _{CC} = ±15 V	-79		
CMRR	Common mode rejection ratio (differential)	V _{CC} = ±5 V or ±15 V	100		dB	
SR	Slew rate	V _{CC} = ±15 V, Gain = 5 V/V, V _O = 20 V _{PP}	1300		V/μs	
		V _{CC} = ±5 V, Gain = 2 V/V, V _O = 5 V _{PP}	900			
V _n	Output noise voltage	V _{CC} = ±12 V to ±15 V R _L = 32 Ω to 64 Ω f = 1 kHz	Gain = 2 V/V	5		μVrms
			Gain = 100 V/V	50		
SNR	Signal-to-noise ratio	V _{CC} = ±12 V to ±15 V R _L = 32 Ω to 64 Ω f = 1 kHz	Gain = 2 V/V	125		dB
			Gain = 100 V/V	104		
Dynamic range		R _L = 32 Ω, f = 1 kHz	V _{CC} = ±12 V	123		dB
			V _{CC} = ±15 V	125		
		R _L = 64 Ω, f = 1 kHz	V _{CC} = ±12 V	124		
			V _{CC} = ±15 V	126		
Crosstalk	V _{CC} = ±12 V to ±15 V R _L = 32 Ω to 64 Ω f = 1 kHz	V _I = 1 V _{RMS} R _F = 1 kΩ	-90		dB	

(1) For IMD, THD+N, k_{SVR}, and crosstalk, the bandwidth of the measurement instruments was set to 80 kHz.

DEVICE INFORMATION

Thermally Enhanced SOIC (DWP)
 PowerPAD™ Package
 Top View

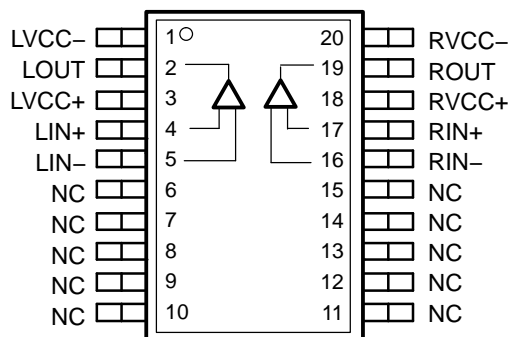

NC – No internal connection

TERMINAL FUNCTIONS

PIN NAME	PIN NUMBER	I/O	DESCRIPTION
LVCC-	1	I	Left channel negative power supply – must be kept at the same potential as RVCC-.
LOUT	2	O	Left channel output
LVCC+	3	I	Left channel positive power supply
LIN+	4	I	Left channel positive input
LIN-	5	I	Left channel negative input
NC	6,7,8,9,10,11,12,13,14,15	-	Not internally connected
RIN-	16	I	Right channel negative input
RIN+	17	I	Right channel positive input
RVCC+	18	I	Right channel positive power supply
ROUT	19	O	Right channel output
RVCC-	20	I	Right channel negative power supply - must be kept at the same potential as LVCC-.
Thermal Pad	-	-	Connect to ground. The thermal pad must be soldered down in all applications to properly secure device on the PCB.

TYPICAL CHARACTERISTICS

Table of Graphs

		FIGURE
Total harmonic distortion + noise	vs Frequency	1, 2, 3, 4
	vs Output voltage	5
	vs Output power	6, 7, 8
Power dissipation	vs Output power	9
Supply voltage rejection ratio	vs Frequency	10, 11
Intermodulation distortion	vs High frequency	12
	vs IM Amplitude	13
Crosstalk	vs Frequency	14
Signal-to-noise ratio	vs Gain	15, 16
Slew rate	vs Output step	17, 18
Small and large signal frequency response		19, 20
400-mV step response		21
10-V step response		22
20-V step response		23

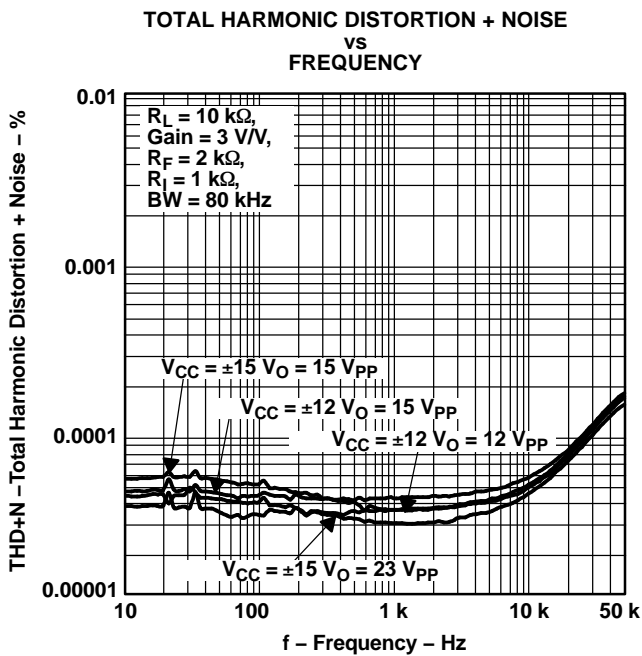

Figure 1.

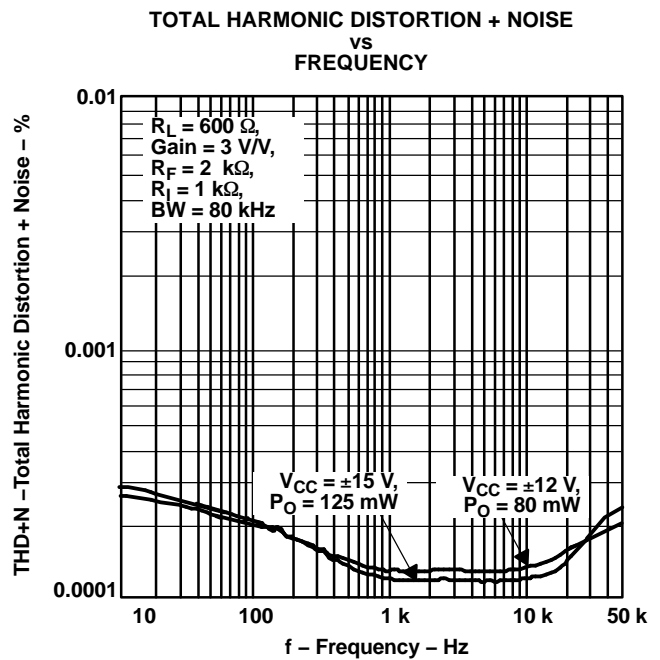

Figure 2.

TYPICAL CHARACTERISTICS (continued)

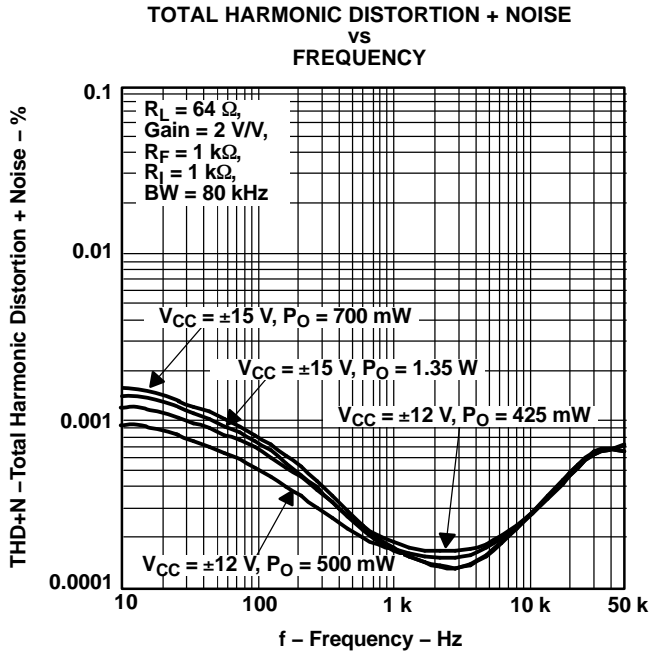

Figure 3.

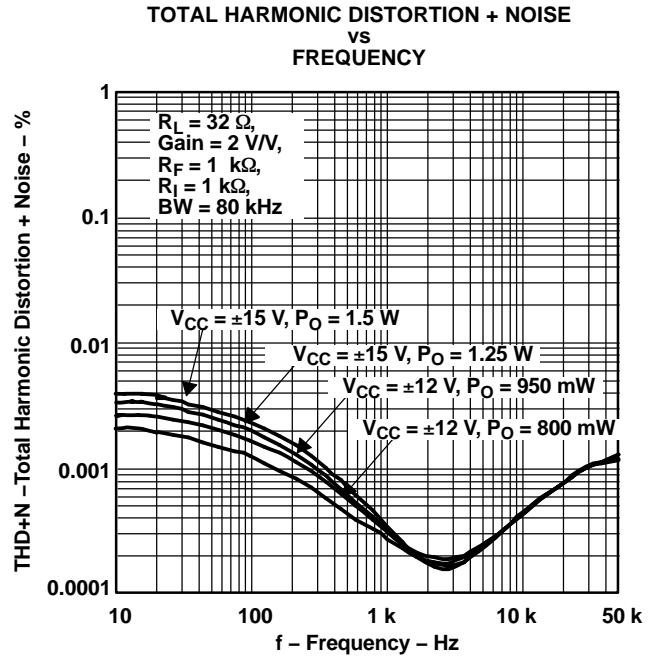

Figure 4.

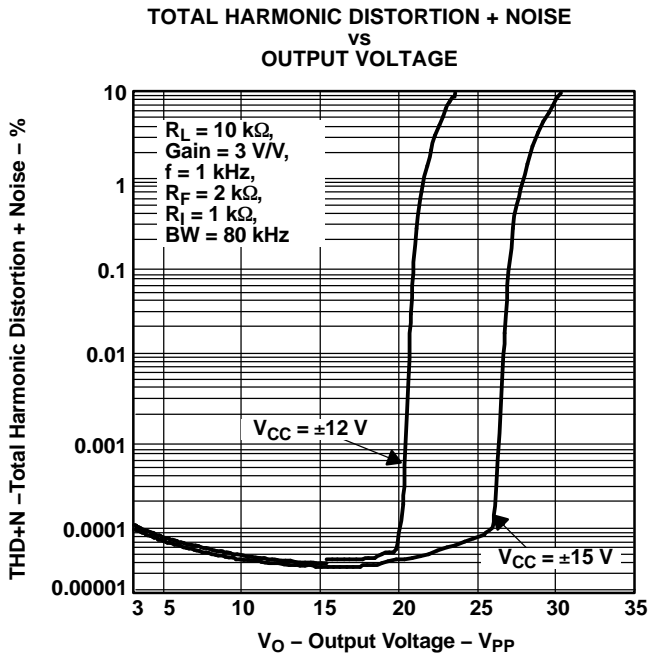

Figure 5.

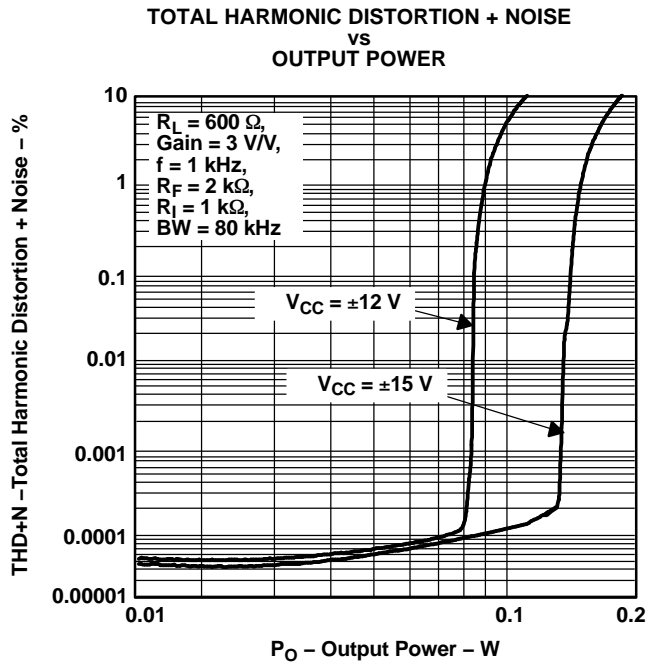

Figure 6.

TYPICAL CHARACTERISTICS (continued)

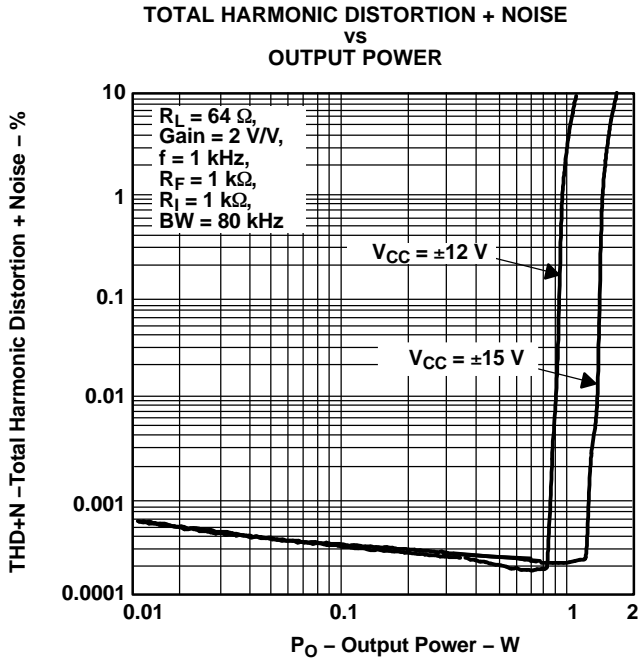

Figure 7.

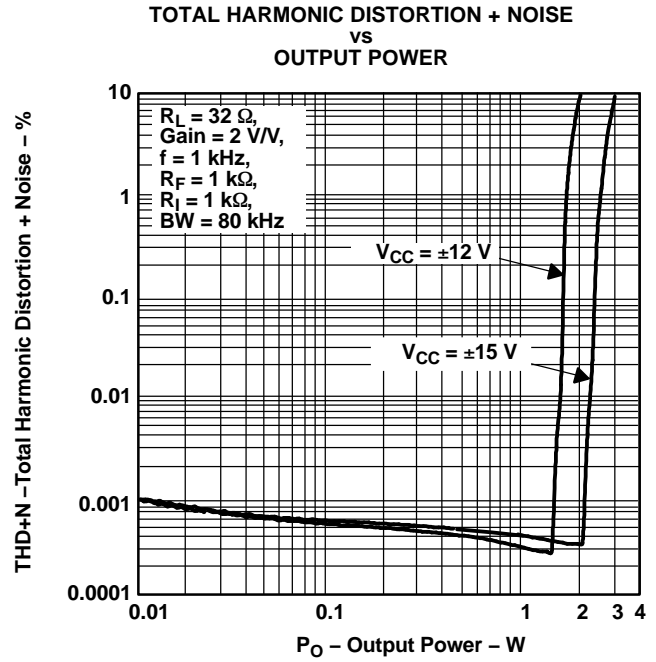

Figure 8.

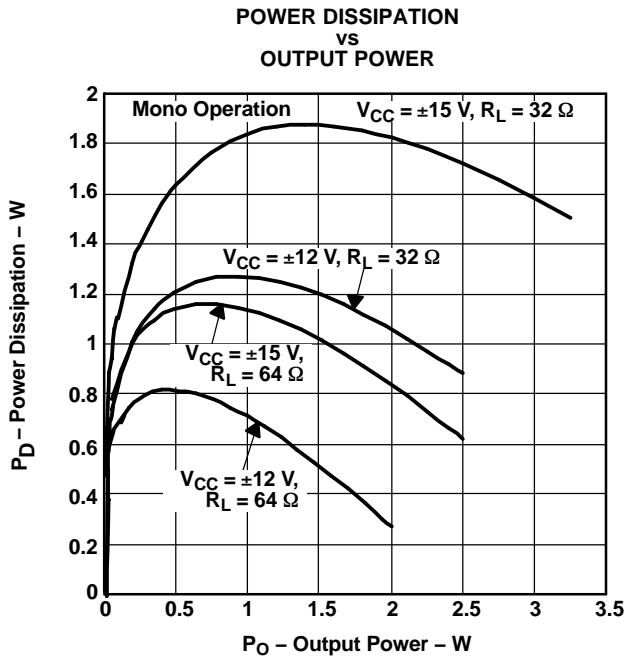

Figure 9.

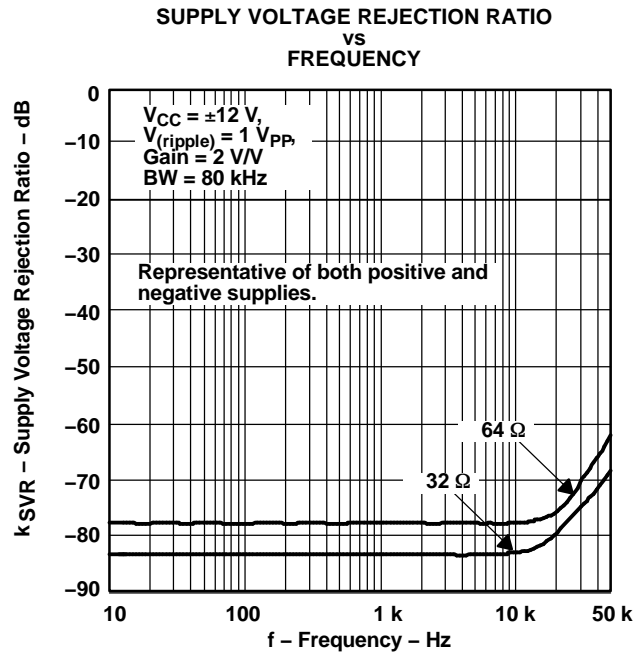

Figure 10.

TYPICAL CHARACTERISTICS (continued)

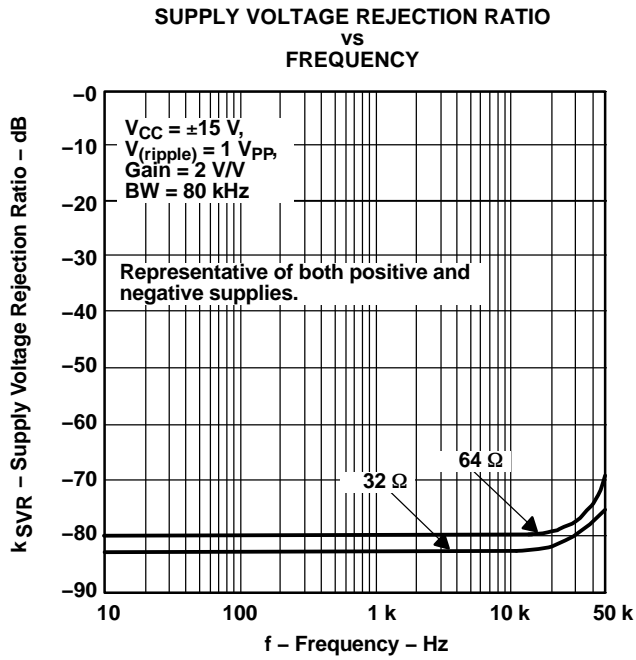

Figure 11.

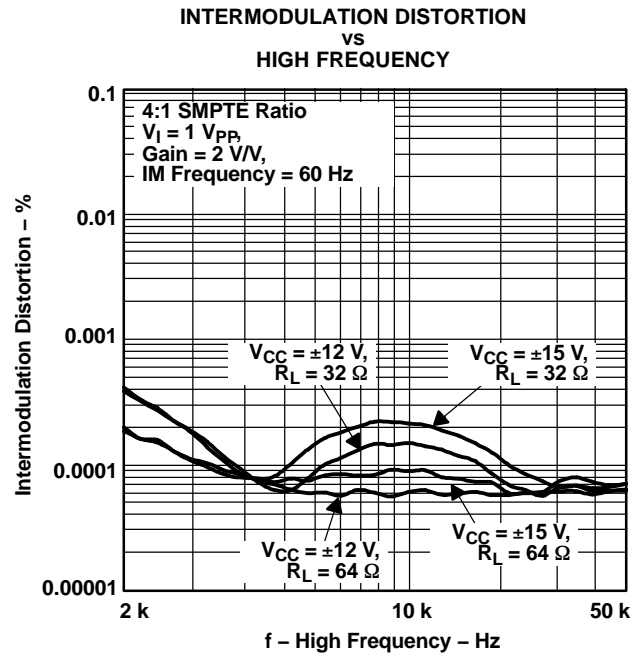

Figure 12.

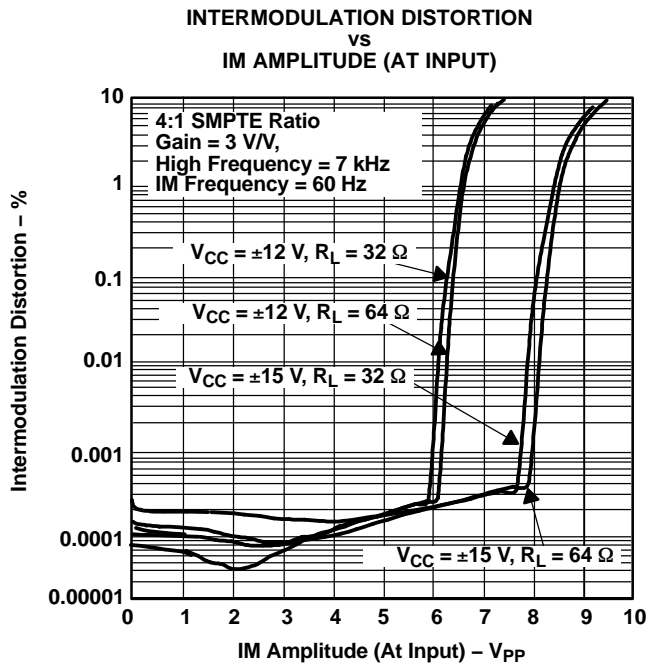

Figure 13.

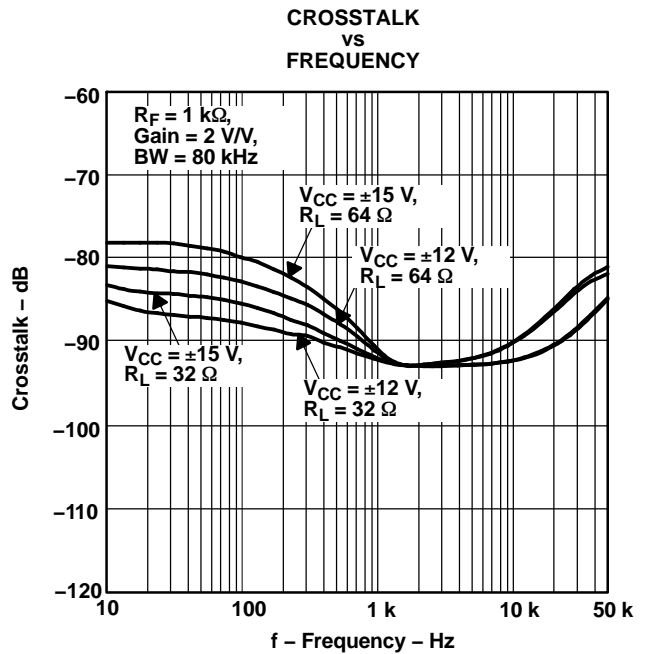

Figure 14.

TYPICAL CHARACTERISTICS (continued)

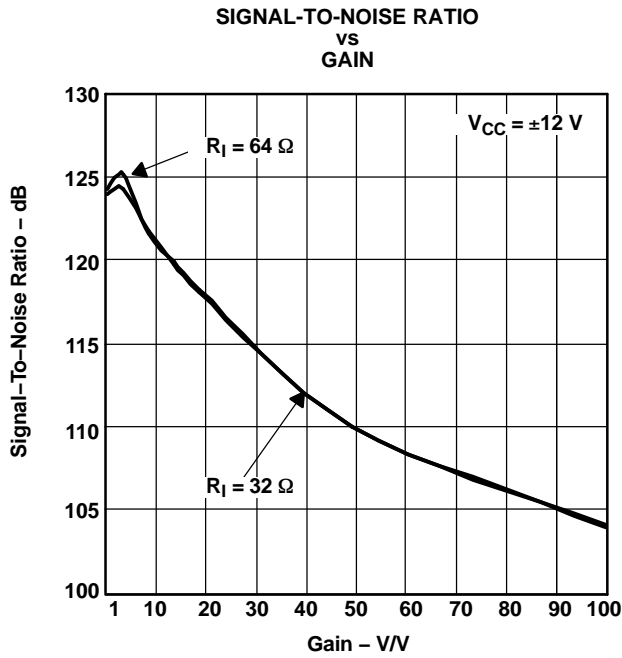

Figure 15.

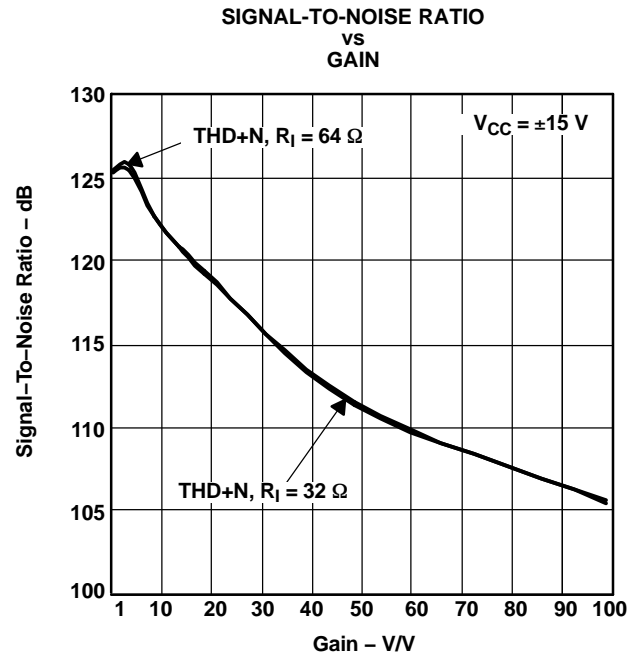

Figure 16.

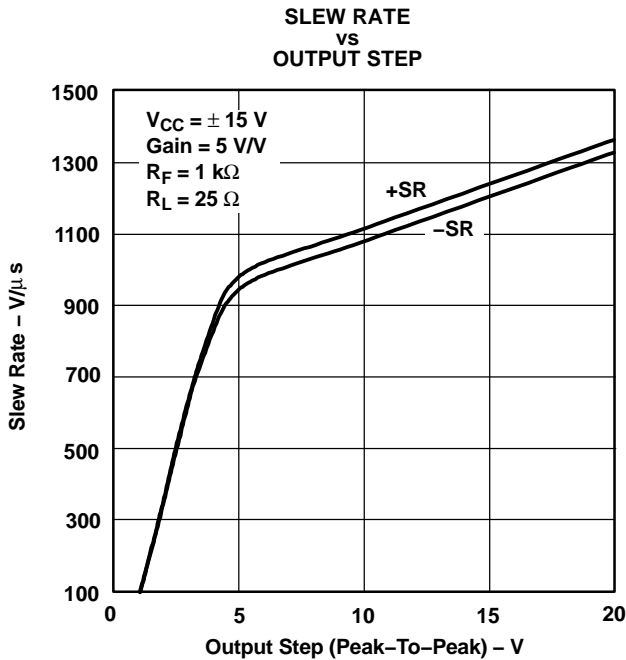

Figure 17.

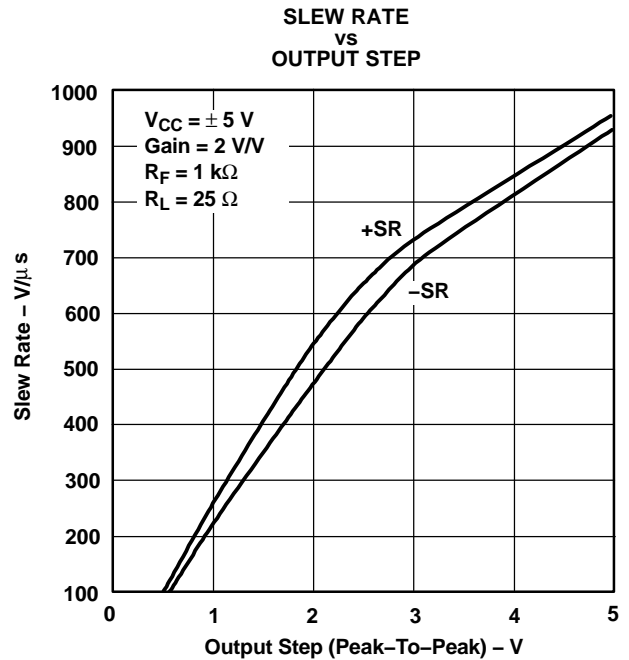

Figure 18.

TYPICAL CHARACTERISTICS (continued)

SMALL AND LARGE SIGNAL FREQUENCY RESPONSE

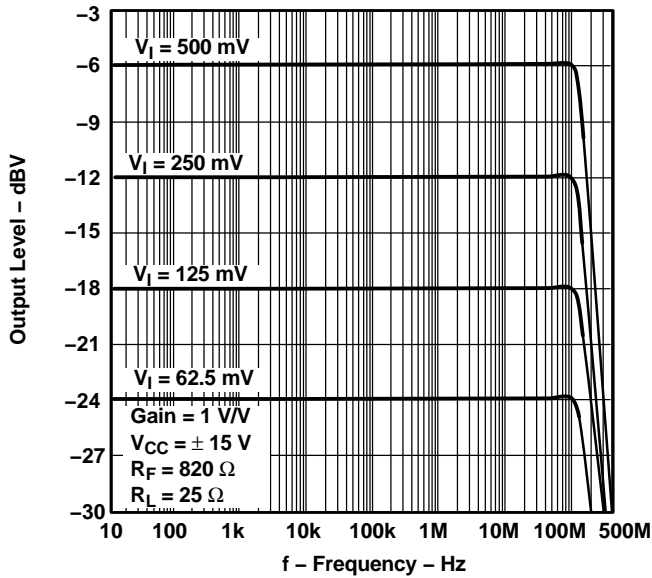

Figure 19.

SMALL AND LARGE SIGNAL FREQUENCY RESPONSE

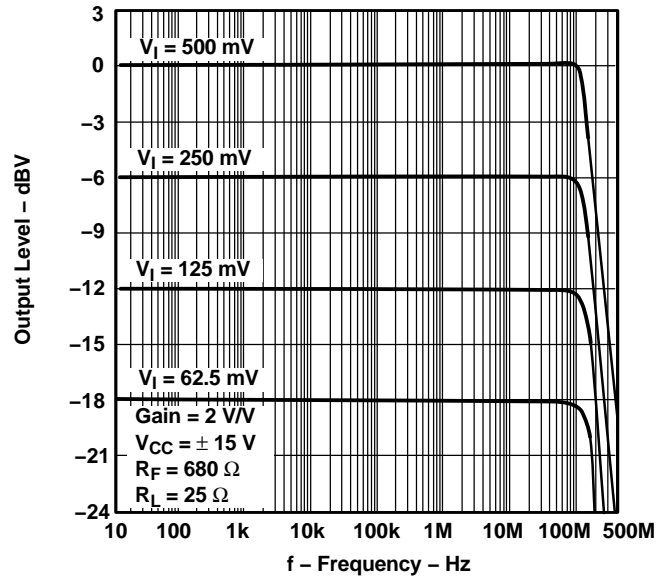

Figure 20.

400-mV STEP RESPONSE

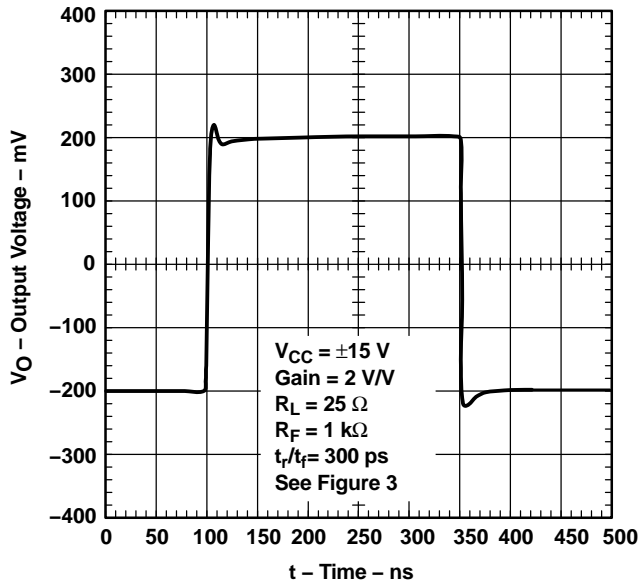

Figure 21.

10-V STEP RESPONSE

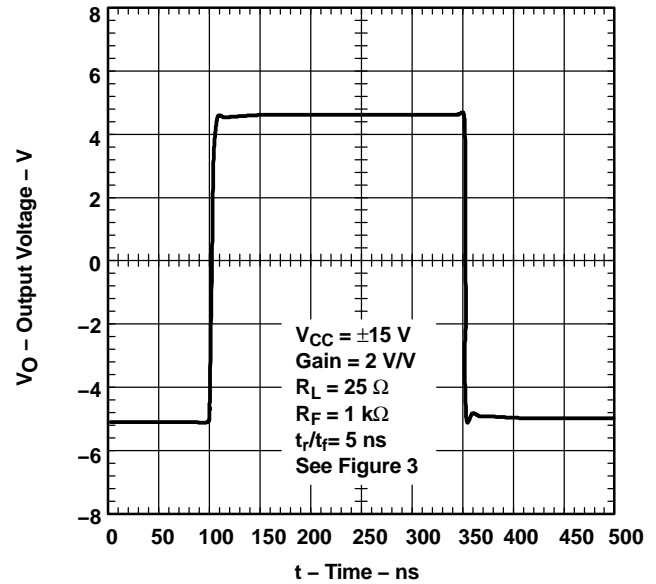
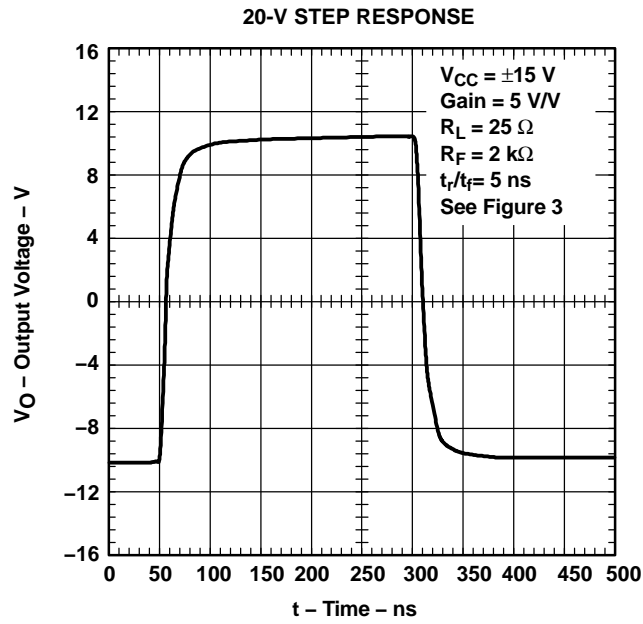

Figure 22.

TYPICAL CHARACTERISTICS (continued)



APPLICATION INFORMATION

Current-Feedback Amplifiers

The TPA6120A2 is a current-feedback amplifier with differential inputs and single-ended outputs. Current-feedback results in low voltage noise, high open-loop gain throughout a large frequency range, and low distortion. It can be used in a similar fashion as voltage-feedback amplifiers. The low distortion of the TPA6120A2 results in a signal-to-noise ratio of 120 dB as well as a dynamic range of 120 dB.

Independent Power Supplies

The TPA6120A2 consists of two independent high-fidelity amplifiers. Each amplifier has its own voltage supply. This allows the user to leave one of the amplifiers off, saving power, and reducing the heat generated. It also reduces crosstalk.

Although the power supplies are independent, there are some limitations. When both amplifiers are used, the same voltage must be applied to each amplifier. For example, if the left channel amplifier is connected to a $\pm 12\text{-V}$ supply, the right channel amplifier must also be connected to a $\pm 12\text{-V}$ supply. If it is connected to a different supply voltage, the device may not operate properly and consistently.

When the use of only one amplifier is preferred, it must be the left amplifier. The voltage supply to the left amplifier is also responsible for internal start-up and bias circuitry of the device. Regardless of whether one or both amplifiers are used, the V_{CC-} pins of both amplifiers must always be at the same potential.

To power down the right channel amplifier, disconnect the V_{CC+} pin from the power source.

The two independent power supplies can be tied together on the board to receive their power from the same source.

Power Supply Decoupling

As with any design, proper power supply decoupling is essential. It prevents noise from entering the device via the power traces and provides the extra power the device can sometimes require in a rapid fashion. This prevents the device from being momentarily current starved. Both of these functions serve to reduce distortion, leaving a clean, uninterrupted signal at the output.

Bulk decoupling capacitors should be used where the main power is brought to the board. Smaller capacitors should be placed as close as possible to the actual power pins of the device. Because the TPA6120A2 has four power pins, use four surface mount capacitors. Both types of capacitors should be low ESR.

Resistor Values

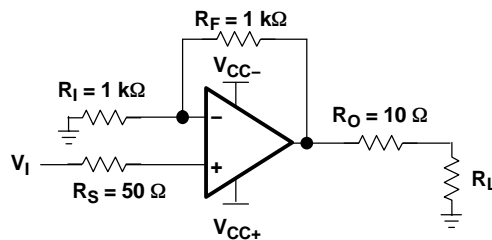

Figure 24. Single-Ended Input With a Noninverting Gain of 2 V/V

In the most basic configuration (see Figure 24), four resistors must be considered, not including the load impedance. The feedback and input resistors, R_F and R_I , respectively, determine the closed-loop gain of the amplifier. R_O is a series output resistor designed to protect the amplifier from any capacitance on the output path, including board and load capacitance. R_S is a series input resistor. Because the TPA6120A2 is a current-feedback amplifier, take care when choosing the feedback resistor.

APPLICATION INFORMATION (continued)

The value of the feedback resistor should be chosen by using Figure 27 through Figure 32 as guidelines. The gain can then be set by adjusting the input resistor. The smaller the feedback resistor, the less noise is introduced into the system. However, smaller values move the dominant pole to higher and higher frequencies, making the device more susceptible to oscillations. Higher feedback resistor values add more noise to the system, but pull the dominant pole down to lower frequencies, making the device more stable. Higher impedance loads tend to make the device more unstable. One way to combat this problem is to increase the value of the feedback resistor. It is not recommended that the feedback resistor exceed a value of 10 k Ω . The typical value for the feedback resistor for the TPA6120A2 is 1 k Ω . In some cases, where a high-impedance load is used along with a relatively large gain and a capacitive load, it may be necessary to increase the value of the feedback resistor from 1 k Ω to 2 k Ω , thus adding more stability to the system. Another method to deal with oscillations is to increase the size of R_O .

CAUTION:

Do not place a capacitor in the feedback path. Doing so can cause oscillations.

Capacitance at the outputs can cause oscillations. Capacitance from some sources, such as layout, can be minimized. Other sources, such as those from the load (e.g., the inherent capacitance in a pair of headphones), cannot be easily minimized. In this case, adjustments to R_O and/or R_F may be necessary.

The series output resistor should be kept at a minimum of 10 Ω . It is small enough so that the effect on the load is minimal, but large enough to provide the protection necessary such that the output of the amplifier sees little capacitance. The value can be increased to provide further isolation, up to 100 Ω .

The series resistor, R_S , should be used for two reasons:

1. It prevents the positive input pin from being exposed to capacitance from the line and source.
2. It prevents the source from seeing the input capacitance of the TPA6120A2.

The 50- Ω resistor was chosen because it provides ample protection without interfering in any noticeable way with the signal. Not shown is another 50- Ω resistor that can be placed on the source side of R_S to ground. In that capacity, it serves as an impedance match to any 50- Ω source.

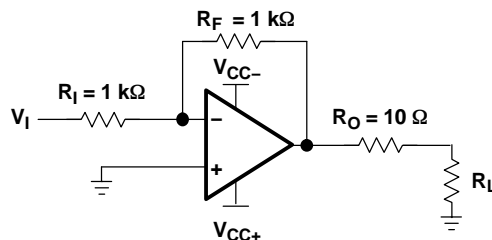

Figure 25. Single-Ended Input With a Noninverting Gain of -1 V/V

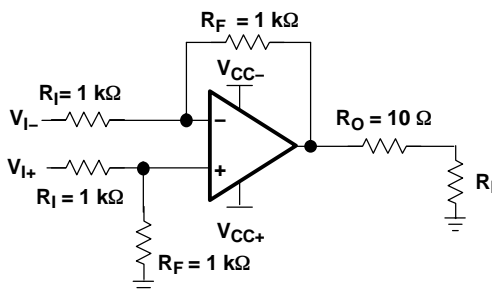

Figure 26. Differential Input With a Noninverting Gain of 2 V/V

Figure 26 shows the TPA6120A2 connected with differential inputs. Differential inputs are useful because they take the greatest advantage of the device's high CMRR. The two feedback resistor values must be kept the same, as do the input resistor values.

APPLICATION INFORMATION (continued)

Special note regarding mono operation:

- If both amplifiers are powered on, but only one channel is to be used, the unused amplifier **MUST** have a feedback resistor from the output to the negative input. Additionally, the positive input should be grounded as close to the pin as possible. Terminate the output as close to the output pin as possible with a 25- Ω load to ground.
- These measures should be followed to prevent the unused amplifier from oscillating. If it oscillates, and the power pins of both amplifiers are tied together, the performance of the amplifier could be seriously degraded.

Checking for Oscillations and Instability

Checking the stability of the amplifier setup is recommended. High frequency oscillations in the megahertz region can cause undesirable effects in the audio band.

Sometimes, the oscillations can be quite clear. An unexpectedly large draw from the power supply may be an indication of oscillations. These oscillations can be seen with an oscilloscope. However, if the oscillations are not obvious, or there is a chance that the system is stable but close to the edge, placing a scope probe with 10 pF of capacitance can make the oscillations worse, or actually cause them to start.

A network analyzer can be used to determine the inherent stability of a system. An output vs frequency curve generated by a network analyzer can be a good indicator of stability. At high frequencies, the curve shows whether a system is oscillating, close to oscillation, or stable. Looking at Figure 27 through Figure 32, several different phenomena occur. In one scenario, the system is stable because the high frequency rolloff is smooth and has no peaking. Increasing R_F decreases the frequency at which this rolloff occurs (see the Resistor Values section). Another scenario shows some peaking at high frequency. If the peaking is 2 dB, the amplifier is stable as there is still 45 degrees of phase margin. As the peaking increases, the phase margin shrinks, the amplifier and the system, move closer to instability. The same system that has a 2-dB peak has an increased peak when a capacitor is added to the output. This indicates the system is either on the verge of oscillation or is oscillating, and corrective action is required.

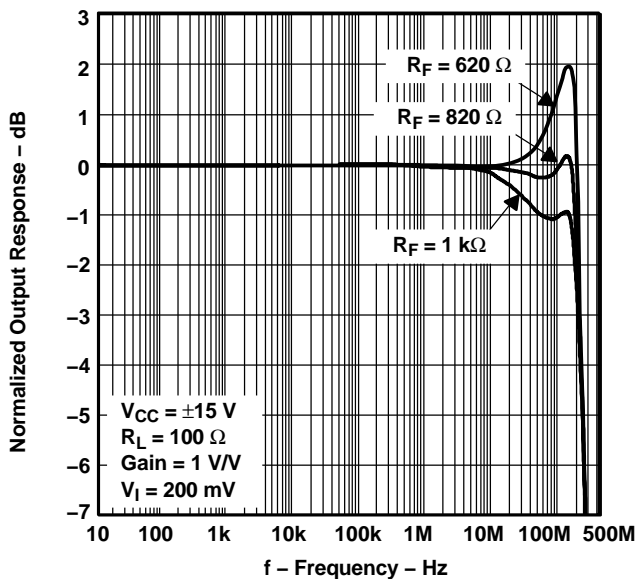

Figure 27. Normalized Output Response vs Frequency

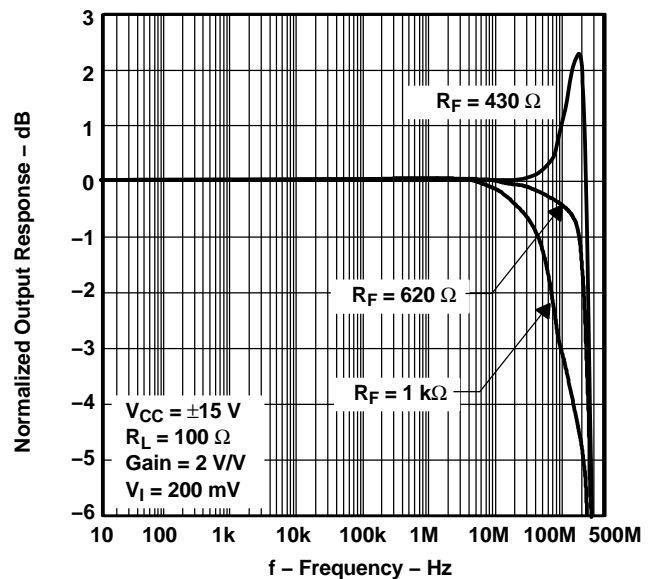

Figure 28. Normalized Output Response vs Frequency

APPLICATION INFORMATION (continued)

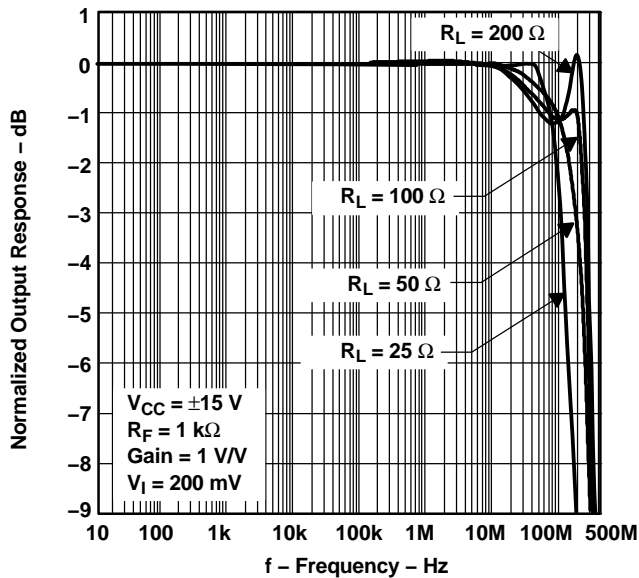

Figure 29. Normalized Output Response vs Frequency

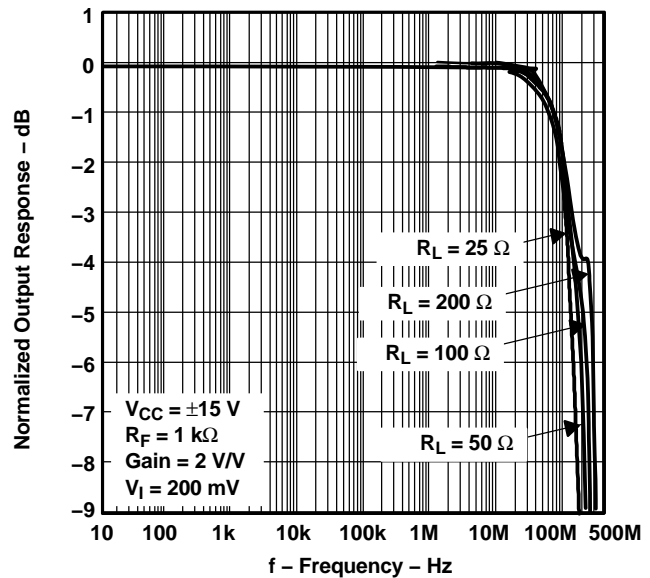

Figure 30. Normalized Output Response vs Frequency

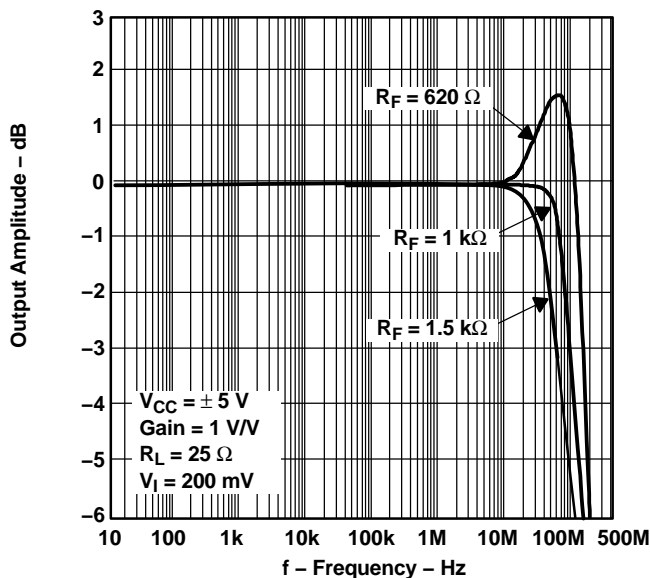

Figure 31. Output Amplitude vs Frequency

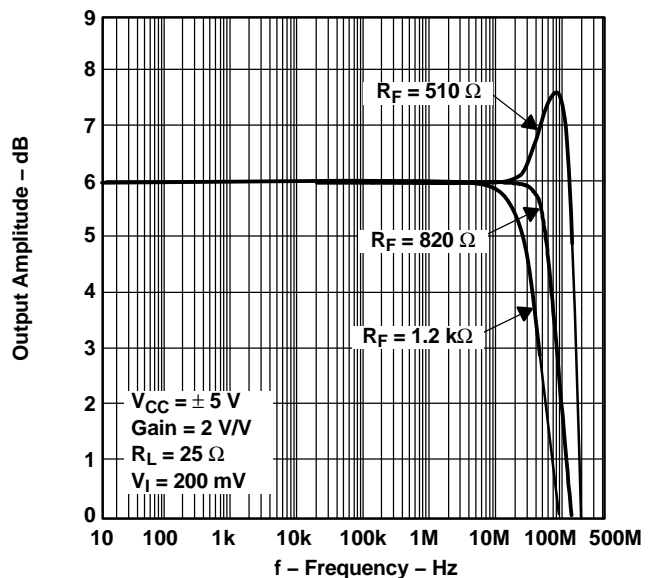

Figure 32. Output Amplitude vs Frequency

PCB Layout

Proper board layout is crucial to getting the maximum performance out of the TPA6120A2.

A ground plane should be used on the board to provide a low inductive ground connection. Having a ground plane underneath traces adds capacitance, so care must be taken when laying out the ground plane on the underside of the board (assuming a 2-layer board). The ground plane is necessary on the bottom for thermal reasons. However, certain areas of the ground plane should be left unfilled. The area underneath the device where the PowerPAD is soldered down should remain, but there should be no ground plane underneath any of the input and output pins. This places capacitance directly on those pins and leads to oscillation problems. The underside ground plane should remain unfilled until it crosses the device side of the input resistors and the output series resistor. Thermal reliefs should be avoided if possible because of the inductance they introduce.

APPLICATION INFORMATION (continued)

Despite the removal of the ground plane in critical areas, stray capacitance can still make its way onto the sensitive outputs and inputs. Place components as close as possible to the pins and reduce trace lengths. See Figure 33 and Figure 34. It is important for the feedback resistor to be extremely close to the pins, as well as the series output resistor. The input resistor should also be placed close to the pin. If the amplifier is to be driven in a noninverting configuration, ground the input close to the device so the current has a short, straight path to the PowerPAD (gnd).

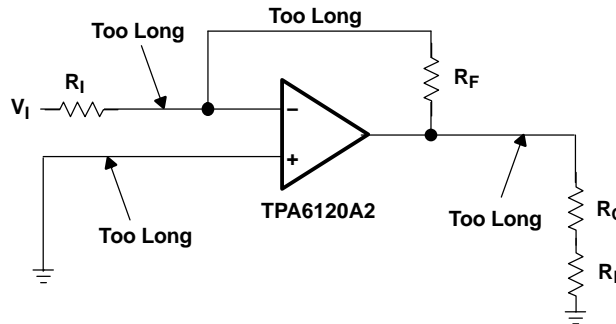

Figure 33. Layout That Can Cause Oscillation

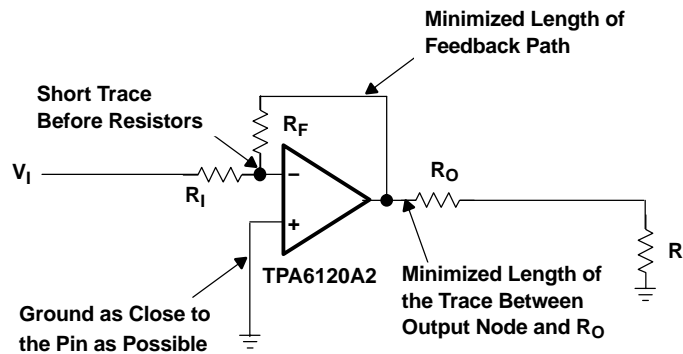

Figure 34. Layout Designed To Reduce Capacitance On Critical Nodes

Thermal Considerations

Amplifiers can generate quite a bit of heat. Linear amplifiers, as opposed to Class-D amplifiers, are extremely inefficient, and heat dissipation can be a problem. There is no one to one relationship between output power and heat dissipation, so the following equations must be used:

$$\text{Efficiency of an amplifier} = \frac{P_L}{P_{SUP}} \tag{1}$$

Where

$$P_L = \frac{V_{LRMS}^2}{R_L}, \text{ and } V_{LRMS} = \frac{V_P}{\sqrt{2}}, \text{ therefore, } P_L = \frac{V_P^2}{2R_L} \text{ per channel} \tag{2}$$

$$P_{SUP} = V_{CC} I_{CCavg} + V_{CC} I_{CC(q)} \tag{3}$$

$$I_{CCavg} = \frac{1}{\pi} \int_0^{\frac{\pi}{2}} \frac{V_P}{R_L} \sin(t) dt = -\frac{V_P}{\pi R_L} [\cos(t)]_0^{\frac{\pi}{2}} = \frac{V_P}{\pi R_L} \tag{4}$$

Where

APPLICATION INFORMATION (continued)

$$V_P = \sqrt{2 P_L R_L} \tag{5}$$

Therefore,

$$P_{SUP} = \frac{V_{CC} V_P}{\pi R_L} + V_{CC} I_{CC(q)} \tag{6}$$

- P_L = Power delivered to load (per channel)
- P_{SUP} = Power drawn from power supply
- V_{LRMS} = RMS voltage on the load
- R_L = Load resistance
- V_P = Peak voltage on the load
- I_{CCavg} = Average current drawn from the power supply
- $I_{CC(q)}$ = Quiescent current (per channel)
- V_{CC} = Power supply voltage (total supply voltage = 30 V if running on a ± 15 -V power supply)
- η = Efficiency of a SE amplifier

For stereo operation, the efficiency does not change because both P_L and P_{SUP} are doubled. This effects the amount of power dissipated by the package in the form of heat.

A simple formula for calculating the power dissipated, P_{DISS} , is shown in Equation 7:

$$P_{DISS} = (1 - \eta) P_{SUP} \tag{7}$$

In stereo operation, P_{SUP} is twice the quantity that is present in mono operation.

The maximum ambient temperature, T_A , depends on the heat-sinking ability of the system. θ_{JA} for a 20-pin DWP, whose thermal pad is properly soldered down, is shown in the dissipation rating table.

$$T_A \text{ Max} = T_J \text{ Max} - \theta_{JA} P_{DISS} \tag{8}$$

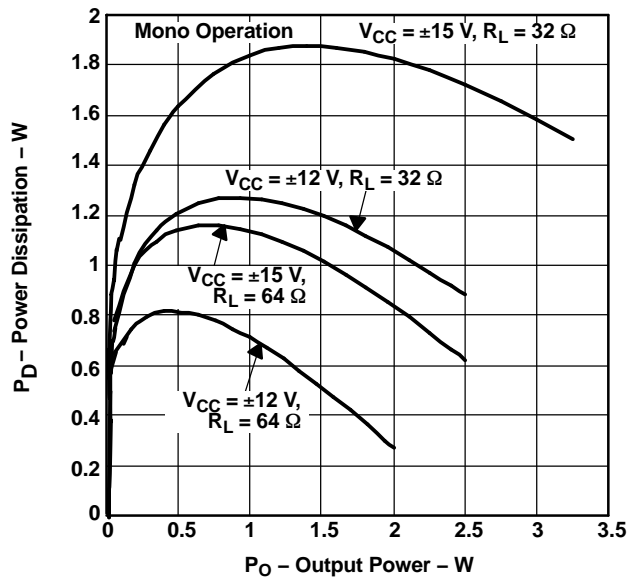

Figure 35. Power Dissipation vs Output Power

Application Circuit

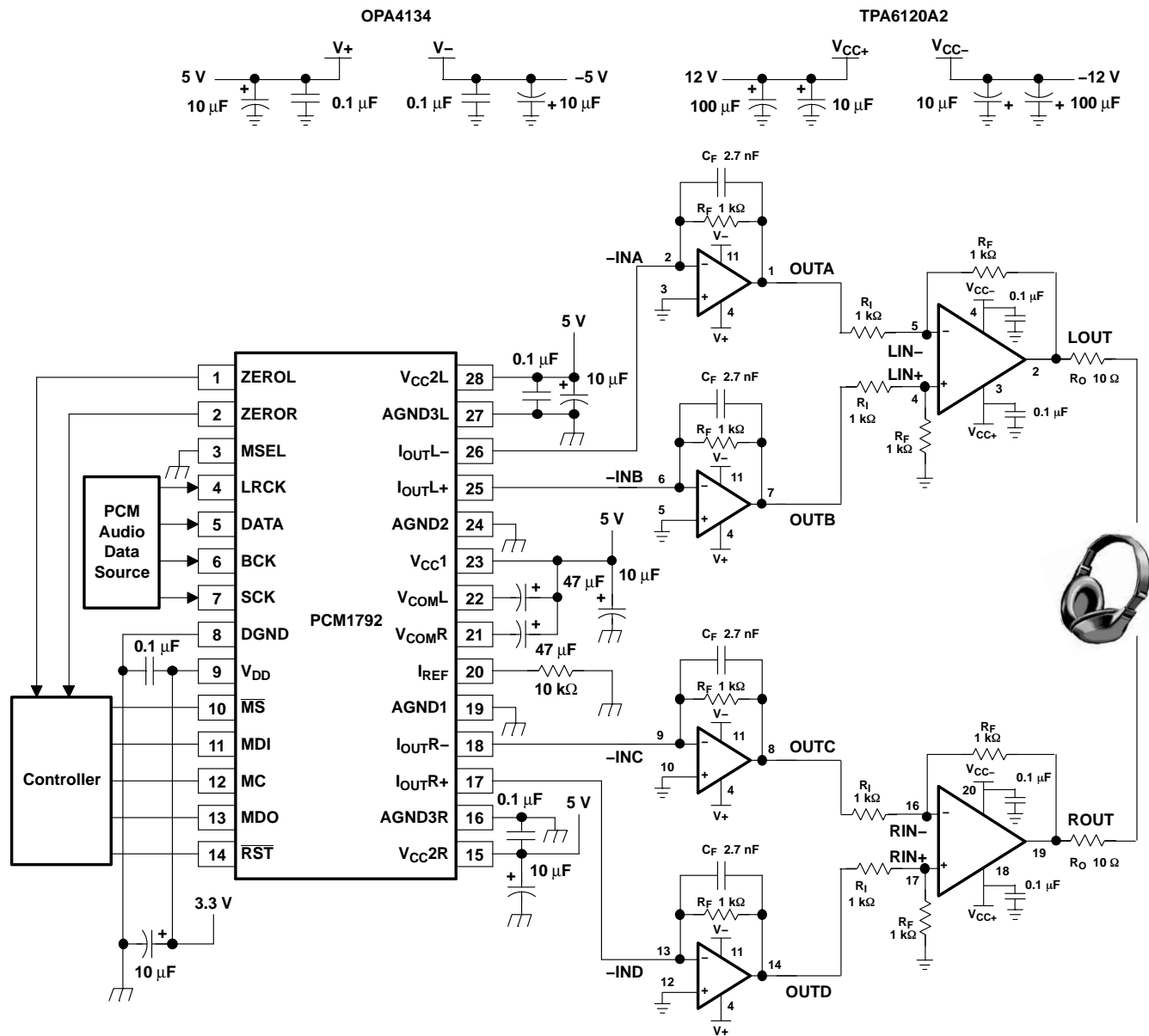

Figure 36. Typical Application Circuit

In many applications, the audio source is digital. It must go through a digital-to-analog converter (DAC) so that traditional analog amplifiers can drive the speakers or headphones.

Figure 36 shows a complete circuit schematic for such a system. The digital audio is fed into a high performance DAC. The PCM1792, a Burr-Brown product from TI, is a 24-bit, stereo DAC.

The output of the PCM1792 is current, not voltage, so the OPA4134 is used to convert the current input to a voltage output. The OPA4134, a Burr-Brown product from TI, is a low-noise, high-speed, high-performance operational amplifier. C_F and R_F are used to set the cutoff frequency of the filter. The RC combination in Figure 36 has a cutoff frequency of 59 kHz. All four amplifiers of the OPA4134 are used so the TPA6120A2 can be driven differentially.

The output of the OPA4134 goes into the TPA6120A2. The TPA6120A2 is configured for use with differential inputs, stereo use, and a gain of 2V/V. Note that the 0.1- μ F capacitors are placed at every supply pin of the TPA6120A2, as well as the 10- Ω series output resistor.

Each output goes to one channel of a pair of stereo headphones, where the listener enjoys crisp, clean, virtually noise free music with a dynamic range greater than the human ear is capable of detecting.

DWP (R-PDSO-G20)

PowerPAD™ PLASTIC SMALL-OUTLINE PACKAGE

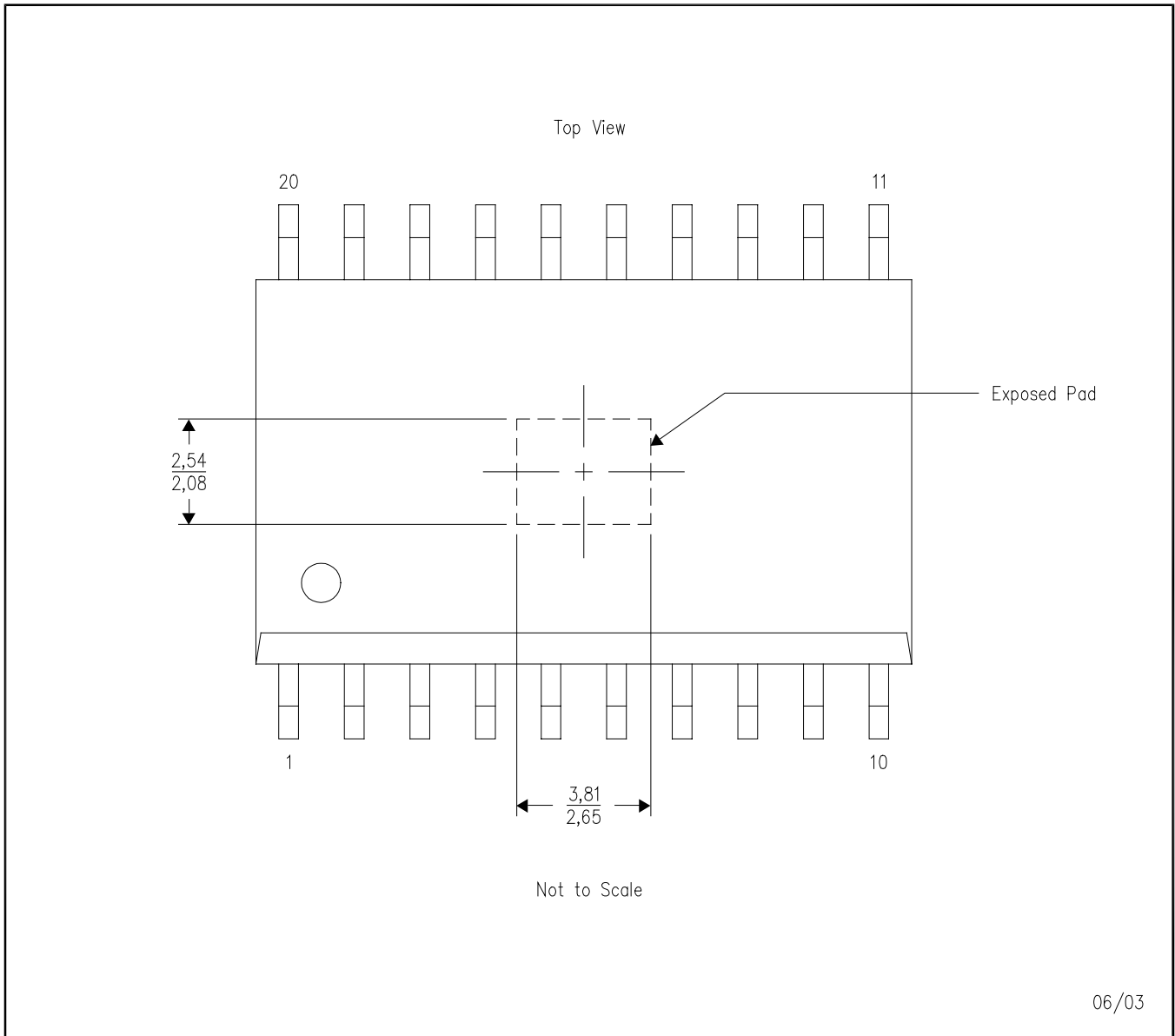

- NOTES:
- A. All linear dimensions are in millimeters.
 - B. This drawing is subject to change without notice.
 - C. For additional information on the PowerPAD™ package and how to take advantage of its heat dissipating abilities, refer to Technical Brief, **PowerPAD Thermally Enhanced Package**, Texas Instruments Literature No. SLMA002 and Application Brief, **PowerPAD Made Easy**, Texas Instruments Literature No. SLMA004. Both documents are available at www.ti.com.

PowerPAD is a trademark of Texas Instruments

MECHANICAL DATA

DWP (R-PDSO-G20)

PowerPAD™ PLASTIC SMALL-OUTLINE PACKAGE

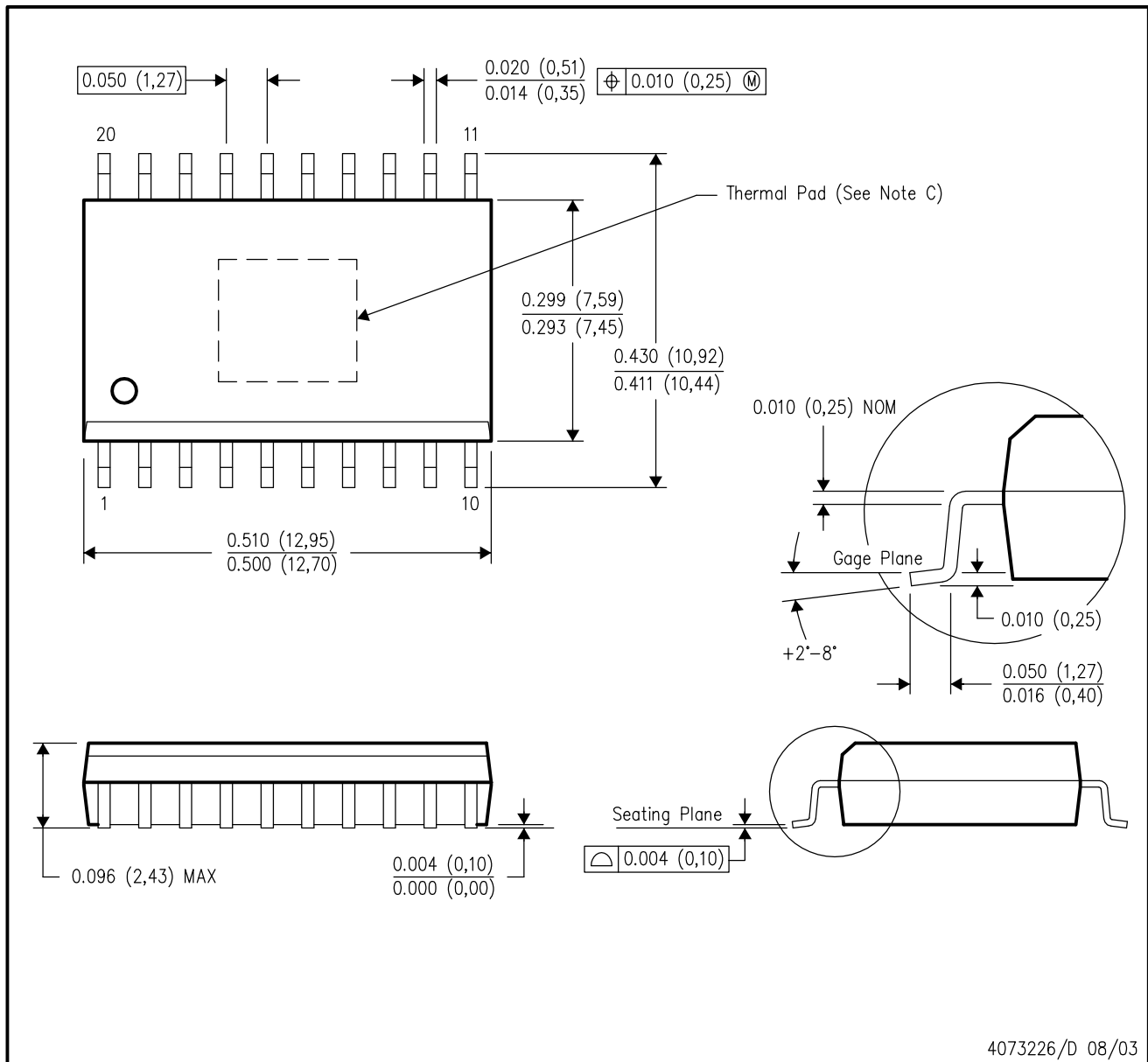

- NOTES:
- All linear dimensions are in inches (millimeters).
 - This drawing is subject to change without notice.
 - This package is designed to be soldered to a thermal pad on the board. Refer to Technical Brief, PowerPad Thermally Enhanced Package, Texas Instruments Literature No. SLMA002 for information regarding recommended board layout. This document is available at www.ti.com <<http://www.ti.com>>.

PowerPAD is a trademark of Texas Instruments.

MECHANICAL DATA

DWP (R-PDSO-G**)

PowerPAD™ PLASTIC SMALL-OUTLINE PACKAGE

20 PINS SHOWN

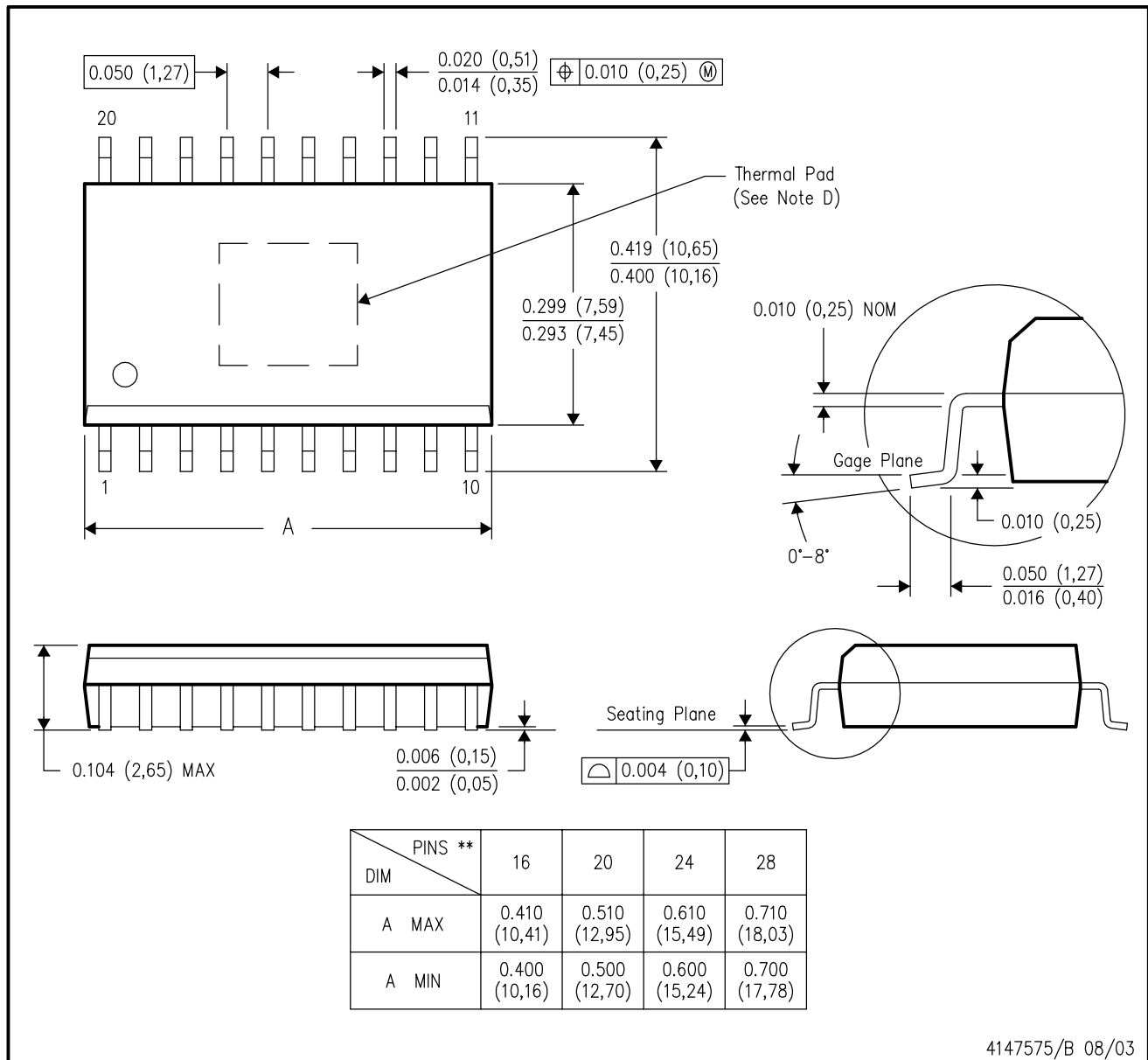

- NOTES:
- All linear dimensions are in inches (millimeters).
 - This drawing is subject to change without notice.
 - Body dimensions do not include mold flash or protrusion not to exceed 0.006 (0,15).
 - This package is designed to be soldered to a thermal pad on the board. Refer to Technical Brief, PowerPad Thermally Enhanced Package, Texas Instruments Literature No. SLMA002 for information regarding recommended board layout. This document is available at www.ti.com <<http://www.ti.com>>.

PowerPAD is a trademark of Texas Instruments.

IMPORTANT NOTICE

Texas Instruments Incorporated and its subsidiaries (TI) reserve the right to make corrections, modifications, enhancements, improvements, and other changes to its products and services at any time and to discontinue any product or service without notice. Customers should obtain the latest relevant information before placing orders and should verify that such information is current and complete. All products are sold subject to TI's terms and conditions of sale supplied at the time of order acknowledgment.

TI warrants performance of its hardware products to the specifications applicable at the time of sale in accordance with TI's standard warranty. Testing and other quality control techniques are used to the extent TI deems necessary to support this warranty. Except where mandated by government requirements, testing of all parameters of each product is not necessarily performed.

TI assumes no liability for applications assistance or customer product design. Customers are responsible for their products and applications using TI components. To minimize the risks associated with customer products and applications, customers should provide adequate design and operating safeguards.

TI does not warrant or represent that any license, either express or implied, is granted under any TI patent right, copyright, mask work right, or other TI intellectual property right relating to any combination, machine, or process in which TI products or services are used. Information published by TI regarding third-party products or services does not constitute a license from TI to use such products or services or a warranty or endorsement thereof. Use of such information may require a license from a third party under the patents or other intellectual property of the third party, or a license from TI under the patents or other intellectual property of TI.

Reproduction of information in TI data books or data sheets is permissible only if reproduction is without alteration and is accompanied by all associated warranties, conditions, limitations, and notices. Reproduction of this information with alteration is an unfair and deceptive business practice. TI is not responsible or liable for such altered documentation.

Resale of TI products or services with statements different from or beyond the parameters stated by TI for that product or service voids all express and any implied warranties for the associated TI product or service and is an unfair and deceptive business practice. TI is not responsible or liable for any such statements.

Following are URLs where you can obtain information on other Texas Instruments products and application solutions:

Products		Applications	
Amplifiers	amplifier.ti.com	Audio	www.ti.com/audio
Data Converters	dataconverter.ti.com	Automotive	www.ti.com/automotive
DSP	dsp.ti.com	Broadband	www.ti.com/broadband
Interface	interface.ti.com	Digital Control	www.ti.com/digitalcontrol
Logic	logic.ti.com	Military	www.ti.com/military
Power Mgmt	power.ti.com	Optical Networking	www.ti.com/opticalnetwork
Microcontrollers	microcontroller.ti.com	Security	www.ti.com/security
		Telephony	www.ti.com/telephony
		Video & Imaging	www.ti.com/video
		Wireless	www.ti.com/wireless

Mailing Address: Texas Instruments
Post Office Box 655303 Dallas, Texas 75265