

AK 502/.. DS - 5,0 - V - grey

**2-12 poles, Spacing 5,0 mm
insert required no. of poles ..**

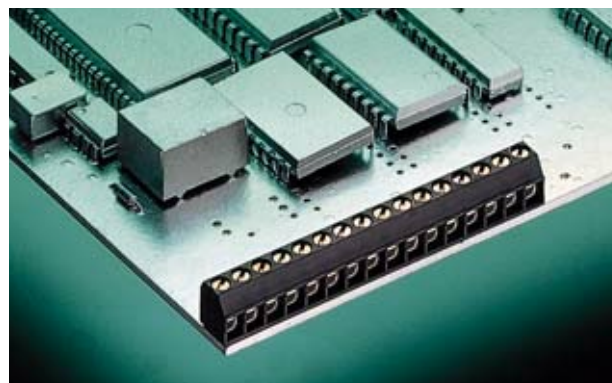
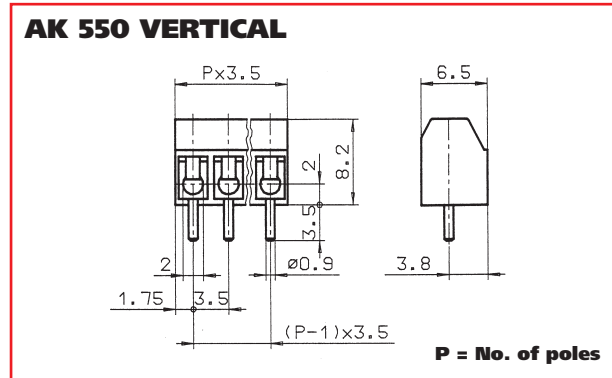

AK 550/.. DS - 3,5 - V - grey

**2-16 poles, Spacing 3,5 mm
insert required no. of poles ..**

Ratings: * Approval pending

	UL 1059	CSA 22.2 No. 158	EN 60998
Rated Voltage	300 V	300 V	250 V
Rated Current	15 A	15 A	17,5 A (T60)
Wire Size	AWG 22-14	AWG 22-14	1,5 mm ²
Test Voltage			2,0 kV
Rated Torque / Screw Size			0,4 Nm/M2,6
Max. Rated Cross Section			
Single Wired (solid)			1,5 mm ²
Stranded Wire (flexible)			1,0 mm ²
Stranded wire with Ferrules			0,75 mm ²

Dimensions

Spacing	5,0 mm
PCB Hole Diameter	1,3 mm
Stripped Length	6,0 mm
Materials	
Insulating Material	PA
Flammability Class	UL94 V-0
Temperature Range	-30°C/+105°C
Terminal Block	CuZn
Wire Guard	CuSn
Colour	
grey	RAL 7016

Ratings:

	UL 1059	CSA 22.2 No. 158	EN 60998
Rated Voltage	125 V	150 V	130 V
Rated Current	6 A	6 A	13,5 A (T60)
Wire Size	AWG 28-16	AWG 28-16	1,0 mm ²
Test Voltage			2,0 kV
Rated Torque / Screw Size			0,4 Nm/M2
Max. Rated Cross Section			
Single Wired (solid)			1,5 mm ²
Stranded Wire (flexible)			1,0 mm ²
Stranded wire with Ferrules			0,75 mm ²

Dimensions

Spacing	3,5 mm
PCB Hole Diameter	1,2 mm
Stripped Length	5,5 mm
Materials	
Insulating Material	PA
Flammability Class	UL94 V-0
Temperature Range	-30°C/+105°C
Terminal Block	CuZn
Wire Guard	CuSn
Colour	
grey	RAL 7016

AK 550 HORIZONTAL

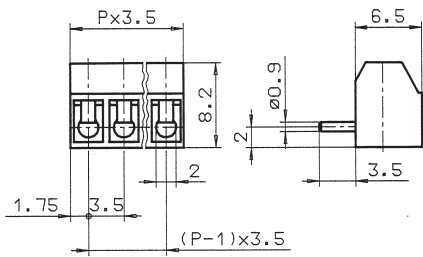

P = No. of poles

AK 550 VERTICAL

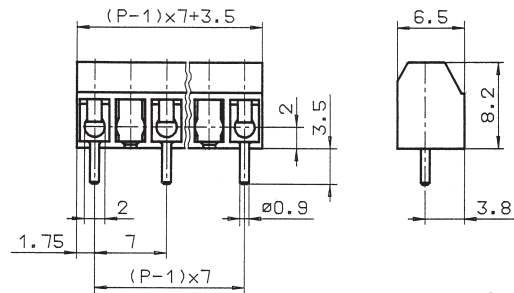

P = No. of poles

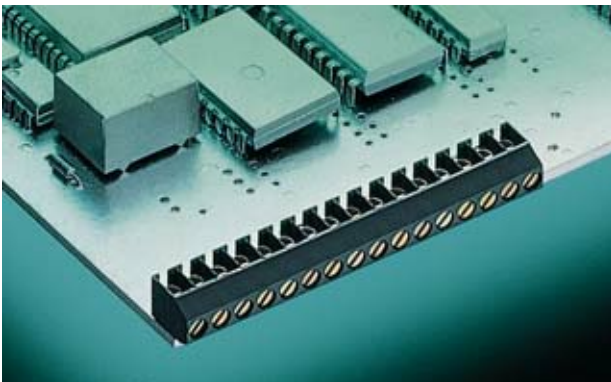

AK 550/.. DS - 3,5 - H - grey

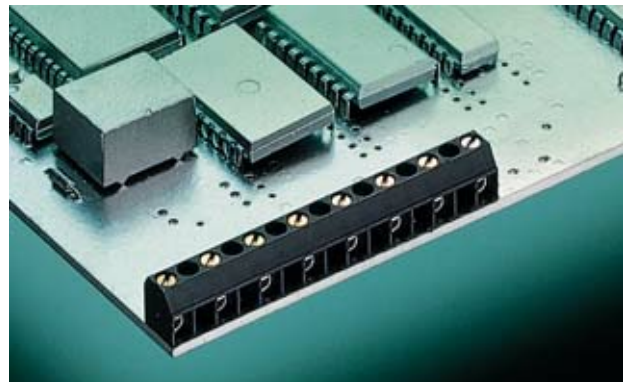

**2-16 poles, Spacing 3,5 mm
insert required no. of poles ..**



AK 550/.. DS - 7,0 - V - grey

**2-8 poles, Spacing 7,0 mm
insert required no. of poles ..**

Ratings:

			
	UL 1059	CSA 22.2 No. 158	EN 60998
Rated Voltage	125 V	150 V	130 V
Rated Current	6 A	6 A	13,5 A (T60)
Wire Size	AWG 28-16	AWG 28-16	1,0 mm ²
Test Voltage			2,0 kV
Rated Torque / Screw Size			0,4 Nm/M2
Max. Rated Cross Section			
Single Wired (solid)			1,5 mm ²
Stranded Wire (flexible)			1,0 mm ²
Stranded wire with Ferrules			0,75 mm ²



Dimensions

Spacing	3,5 mm
PCB Hole Diameter	1,2 mm
Stripped Length	5,5 mm

Materials

Insulating Material	PA
Flammability Class	UL94 V-0
Temperature Range	-30°C/+105°C
Terminal Block	CuZn
Wire Guard	CuSn
Colour	grey
	RAL 7016

Ratings:

			
	UL 1059	CSA 22.2 No. 158	EN 60998
Rated Voltage	300 V	300 V	450 V
Rated Current	6 A	6 A	13,5 A (T60)
Wire Size	AWG 28-16	AWG 28-16	1,0 mm ²
Test Voltage			3,0 kV
Rated Torque / Screw Size			0,4 Nm/M2
Max. Rated Cross Section			
Single Wired (solid)			1,5 mm ²
Stranded Wire (flexible)			1,0 mm ²
Stranded wire with Ferrules			0,75 mm ²

Dimensions

Spacing	7,0 mm
PCB Hole Diameter	1,2 mm
Stripped Length	5,5 mm

Materials

Insulating Material	PA
Flammability Class	UL94 V-0
Temperature Range	-30°C/+105°C
Terminal Block	CuZn
Wire Guard	CuSn
Colour	grey
	RAL 7016

AK 550 HORIZONTAL

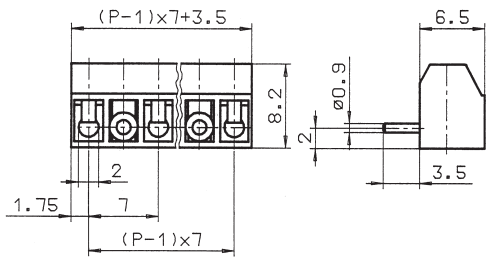

P = No. of poles



AK 550/.. DS - 7,0 - H - grey

**2-8 poles, Spacing 7,0 mm
insert required no. of poles ..**

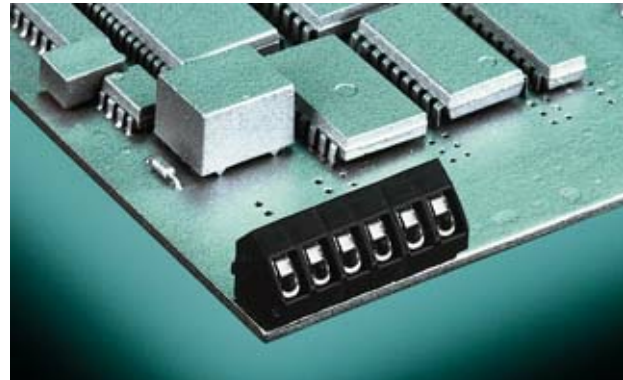
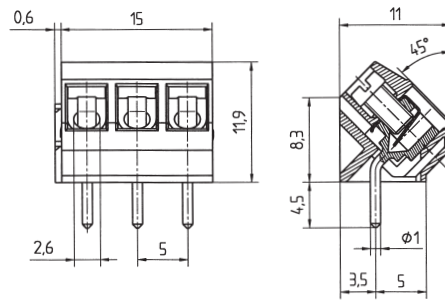

AK 590



AK 590/.. DS- 5,0 - grey

**2-12 poles, Spacing 5,0 mm
insert required no. of poles ..**

Ratings:

			
	UL 1059	CSA 22.2 No. 158	EN 60998
Rated Voltage	300 V	300 V	450 V
Rated Current	6 A	6 A	13,5 A (T60)
Wire Size	AWG 28-16	AWG 28-16	1,0 mm ²
Test Voltage			3,0 kV
Rated Torque / Screw Size			0,4 Nm/M2
Max. Rated Cross Section			
Single Wired (solid)			1,5 mm ²
Stranded Wire (flexible)			1,0 mm ²
Stranded wire with Ferrules			0,75 mm ²



Dimensions

Spacing	7,0 mm
PCB Hole Diameter	1,2 mm
Stripped Length	5,5 mm

Materials

Insulating Material	PA
Flammability Class	UL94 V-0
Temperature Range	-30°C/+105°C
Terminal Block	CuZn
Wire Guard	CuSn
Colour	grey
	RAL 7016

Ratings:

			
	UL 1059	CSA 22.2 No. 158	EN 60998
Rated Voltage	300 V	300 V	250 V
Rated Current	15 A	15 A	17,5 A (T60)
Wire Size	AWG 22-14	AWG 22-14	1,5 mm ²
Test Voltage			2,0 kV
Rated Torque / Screw Size			0,4 Nm/M2,6
Max. Rated Cross Section			
Single Wired (solid)			1,5 mm ²
Stranded Wire (flexible)			1,0 mm ²
Stranded wire with Ferrules			0,75 mm ²

Dimensions

Spacing	5,0 mm
PCB Hole Diameter	1,3 mm
Stripped Length	6,0 mm

Materials

Insulating Material	PA
Flammability Class	UL94 V-0
Temperature Range	-30°C/+105°C
Terminal Block	CuZn
Wire Guard	stainless steel
Colour	grey
	RAL 7016