

DATA SHEET

SA58603

High precision operational amplifier,
comparator, and voltage reference

Product data
Supersedes data of 2001 Oct 03

2002 Nov 13

High precision operational amplifier, comparator, and voltage reference

SA58603

GENERAL DESCRIPTION

The SA58603 is comprised of a low voltage, high precision dual operational amplifier, a comparator, and a reference voltage source. The input offset voltage is typically 100 μV with a very low temperature drift of $\pm 1 \mu\text{V}/^\circ\text{C}$. The SA58603 supply current is typically 100 μA per amplifier and it operates from 1.8 V to 6 V single supply.

Having single power supply capability, low current consumption, low offset voltage, low input offset current and low input bias current, the SA58603 is ideal for battery-powered applications and amplification of very small signals. It is excellent for precision amplifiers in gas burners and gas pilot water heaters which use thermal couple heat sensors.

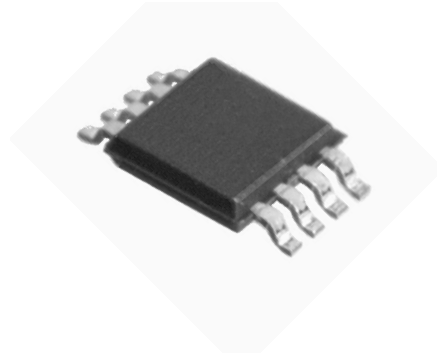

FEATURES

General

- Functionality to 1.8 V typical
- Low supply current: 100 μA per amplifier (typical)

Amplifier section

- Very low input offset voltage: 100 μV (typical)
- Very low input offset drift: $\pm 1 \mu\text{V}/^\circ\text{C}$ (typical)
- Low input offset current: 1 nA (typical)
- Input bias current: 50 nA (typical)
- Open loop gain: 100 dB (typical)
- Common mode input includes ground

Comparator section

- Input offset voltage: $\pm 1.0 \text{ mV}$ (typical)
- Low input offset voltage drift (-40 to $+85 \text{ }^\circ\text{C}$): $\pm 10 \mu\text{V}$ (typical)
- Input bias current: 25 nA (typical)
- Output sink current: 5 mA (minimum)

Reference voltage section

- Reference voltage: $1.27 \text{ V} \pm 50 \text{ mV}$
- Reference voltage temperature characteristics: $\pm 100 \text{ ppm}/^\circ\text{C}$ (typical)
- Output current: 0.3 mA (minimum)

APPLICATIONS

- Gas burners
- Gas water heaters
- Tankless gas water heaters

SIMPLIFIED DEVICE DIAGRAM

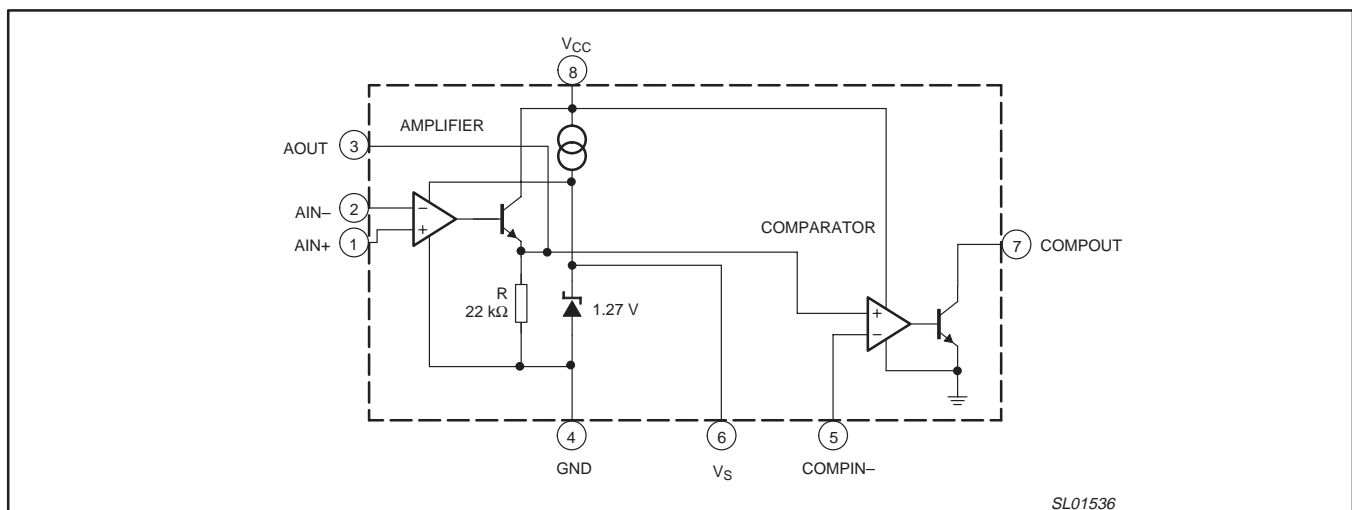

Figure 1. Simplified device diagram.

High precision operational amplifier, comparator, and voltage reference

SA58603

ORDERING INFORMATION

TYPE NUMBER	PACKAGE		TEMPERATURE RANGE
	NAME	DESCRIPTION	
SA58603D	SO8	plastic small outline package; 8 leads; body width 3.9 mm	-40 to +85 °C

PIN CONFIGURATION

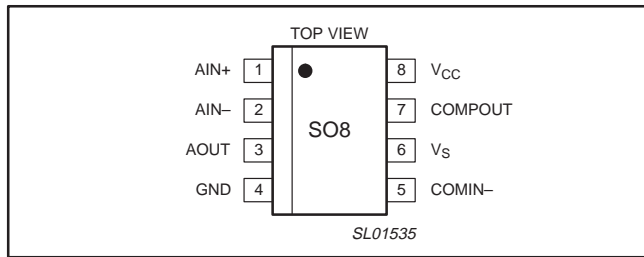

Figure 2. Pin configuration.

PIN DESCRIPTION

PIN	SYMBOL	DESCRIPTION
1	AIN+	Non-inverting input of Op Amp. This is a PNP amplifier with the reference voltage as its supply voltage.
2	AIN-	Inverting input of Op Amp. This is a PNP amplifier with the reference voltage as its supply voltage.
3	AOUT	Output of Op Amp. This is a NPN emitter follower output with a 22 kΩ internal on-chip pull-down resistor. Its supply voltage is V _{CC} .
4	GND	Ground.
5	COMPIN-	Inverting input of Comparator. This is a PNP amplifier with V _{CC} as its positive supply voltage.
6	V _S	Reference voltage output. The output reference is typically 1.27 V. The output reference is derived from the series combination of a NPN transistor (configured as a diode with the base shorted to the collector) and a 120 kΩ resistor.
7	COMPOUT	Output of Comparator. It is an open collector output stage which requires an external pull-up resistor.
8	V _{CC}	Positive supply. Its operating range is 1.8 to 6.0 V.

High precision operational amplifier, comparator, and voltage reference

SA58603

EQUIVALENT CIRCUITS

PIN NUMBER	PIN NAME	INTERNAL EQUIVALENT CIRCUIT	PIN NUMBER	PIN NAME	INTERNAL EQUIVALENT CIRCUIT
1	AIN+		5	COMPIN-	
2	AIN-		6	V_S	
3	AOUT		7	COMPOUT	
4	GND		8	V_CC	

MAXIMUM RATINGS

SYMBOL	PARAMETER	MIN.	MAX.	UNIT
V _{CC}	Single supply voltage	-0.3	+10	V
V _{IN}	Input voltage	-0.3	+10	V
T _{stg}	Storage temperature	-40	+125	°C
T _{amb}	Operating temperature	-40	+85	°C
P	Power dissipation	-	300	mW

High precision operational amplifier, comparator, and voltage reference

SA58603

ELECTRICAL CHARACTERISTICS

$V_{CC} = 3.0\text{ V}$, $V_{IN} = 0\text{ V}$, and $T_{amb} = 25\text{ °C}$, unless otherwise specified.

SYMBOL	PARAMETER	CONDITIONS	MIN.	TYP.	MAX.	UNIT
I_{CC}	Supply current		–	0.1	0.15	mA
I_{OVS}	Reference voltage output current		0.3	–	–	mA
V_S	Reference voltage		1.22	1.27	1.32	V
ΔV_S	Reference voltage temperature drift		–	± 100	–	ppm/°C
PSRR	Power supply rejection ratio	$f = 100\text{ Hz}$	50	60	–	dB
V_{CC}	Power supply voltage operating range		1.8	3.0	6.0	V
Amplifier section (note 1)						
V_{INA}	Input voltage range		–0.2	–	0.3	V
V_{IOA}	Input offset voltage		–	± 0.1	± 0.35	mV
$\Delta V_{IO}/\Delta T$	Input offset voltage temperature drift	$T_{amb} = -20\text{ to }+75\text{ °C}$	–	± 1	± 3	$\mu\text{V}/\text{°C}$
I_{IOA}	Input offset current		–	1	10	nA
$I_{i(\text{bias})A}$	Input bias current		–	50	150	nA
$G_{V(\text{ol})A}$	Open-loop voltage gain		80	100	–	dB
I_{OA}	Output current	$V_{IN} = 10\text{ mV}$; $V_O = 0.5\text{ V}$	0.5	–	–	mA
V_{OA}	Output voltage swing	$V_{IN} = -5\text{ to }+25\text{ mV}$; $R_L = 10\text{ k}\Omega$	0.01	–	$V_{CC} - 1.0$	V
Comparator section (note 2)						
V_{IOC}	Input offset voltage	$V_{IN} = -5\text{ mV}$	–	± 1.0	± 3.5	mV
$\Delta V_{IOC}/\Delta T$	Input offset voltage temperature drift	$V_{IN} = -5\text{ mV}$	–	± 10	± 30	$\mu\text{V}/\text{°C}$
$I_{i(\text{bias})C}$	Input bias current	$V_{IN} = -5\text{ mV}$	–	25	75	nA
$I_{O(\text{sink})}$	Output sink current	$V_{IN} = 10\text{ mV}$; $V_O = 0.4\text{ V}$	5	–	–	mA
I_{LO}	Output leakage current	$V_O = V_{CC} + 1\text{ V}$	–	–	0.2	μA
V_{SAT}	Output saturation voltage	$V_{IN} = 10\text{ mV}$; $I_{O(\text{sink})} = 5\text{ mA}$	–	200	400	mV

NOTES:

1. Amplifier output is emitter follower with an on-chip 22 k Ω pull-down resistor.
2. Comparator output is open collector; it requires an external pull-up resistor. See application section on how to determine this resistor.

High precision operational amplifier, comparator, and voltage reference

SA58603

TYPICAL CHARACTERIZATION CURVES

$T_{amb} = 25\text{ }^{\circ}\text{C}$, $V_{CC} = 3\text{ V}$, $V_{IN} = 0\text{ V}$, unless otherwise specified.

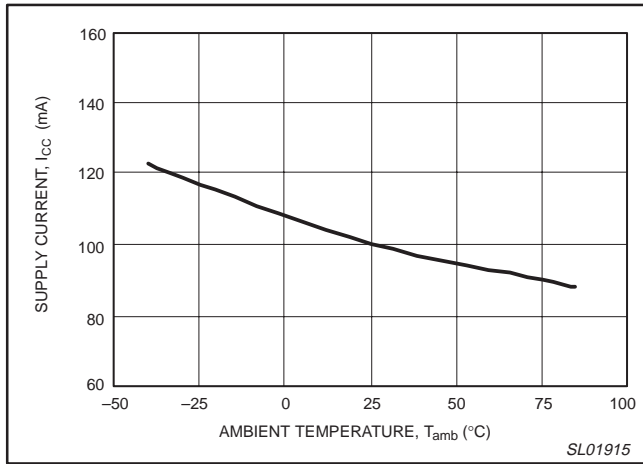

Figure 3. Supply current versus ambient temperature.

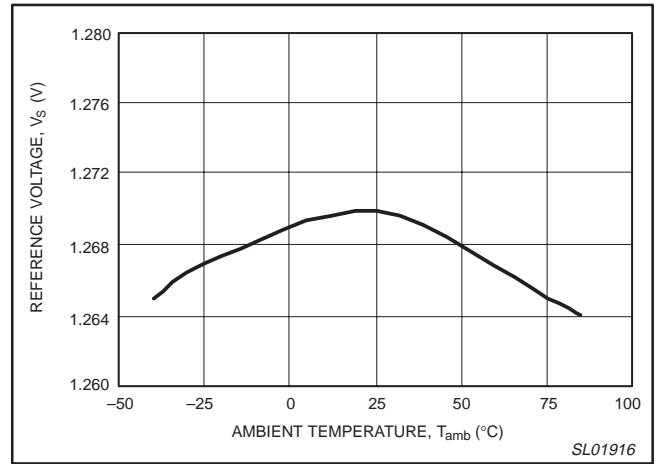

Figure 4. Reference voltage versus ambient temperature.

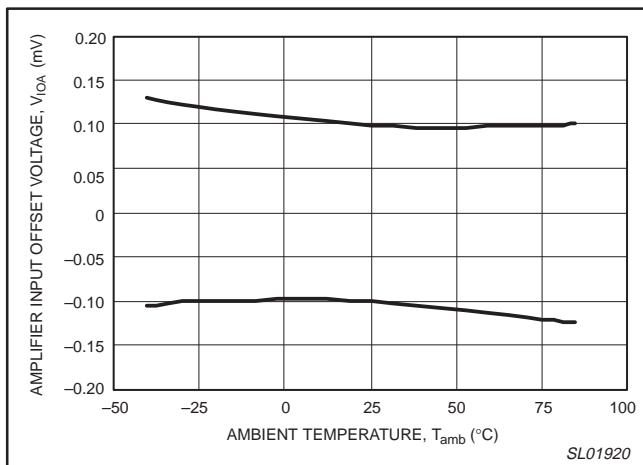

Figure 5. Amplifier input offset voltage versus ambient temperature.

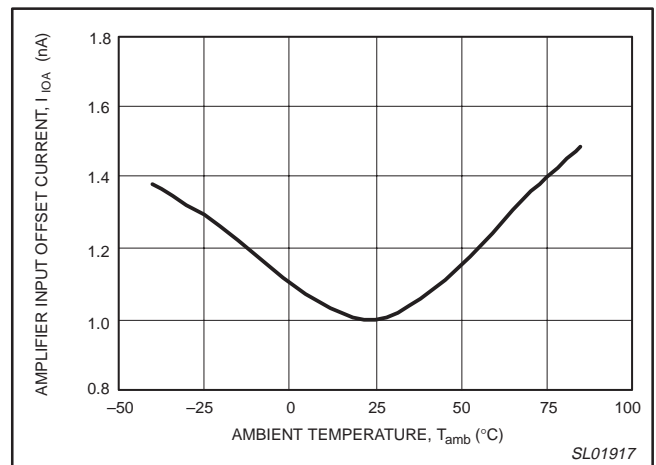

Figure 6. Amplifier input offset current versus ambient temperature.

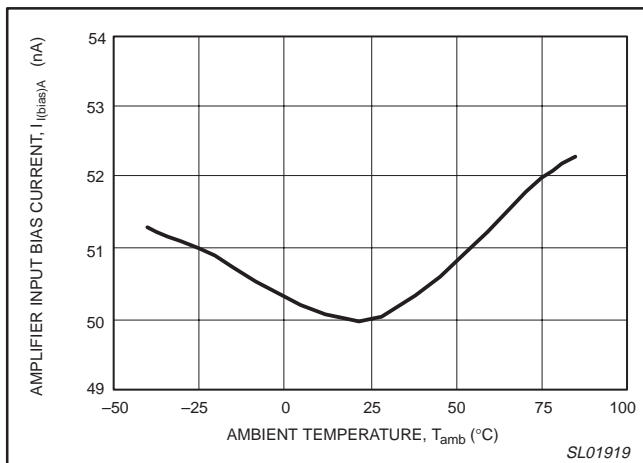

Figure 7. Amplifier input bias current versus ambient temperature.

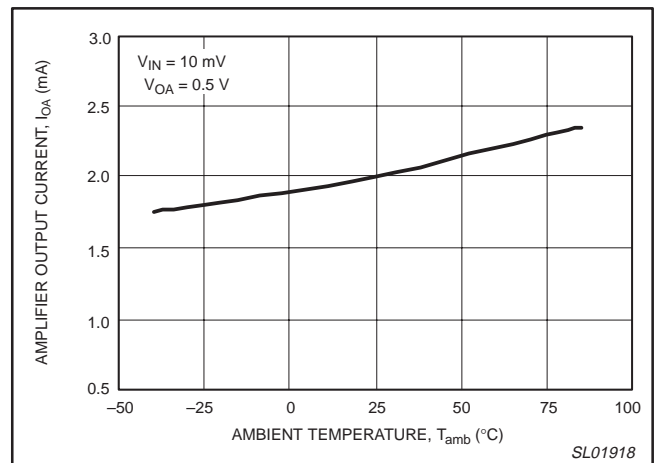

Figure 8. Amplifier output current versus ambient temperature.

High precision operational amplifier, comparator, and voltage reference

SA58603

TYPICAL CHARACTERIZATION CURVES (continued)

$T_{amb} = 25\text{ }^{\circ}\text{C}$, $V_{CC} = 3\text{ V}$, $V_{IN} = 0\text{ V}$, unless otherwise specified.

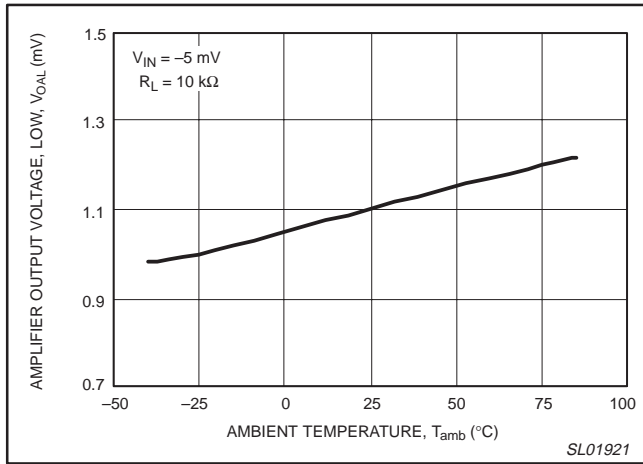

Figure 9. Amplifier output voltage, LOW versus ambient temperature.

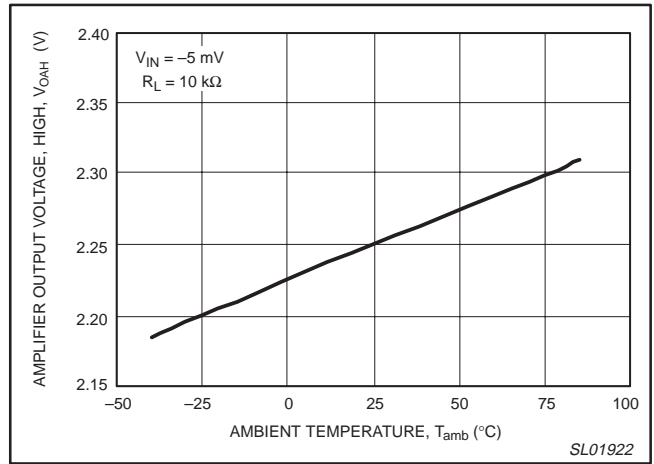

Figure 10. Amplifier output voltage, HIGH versus ambient temperature.

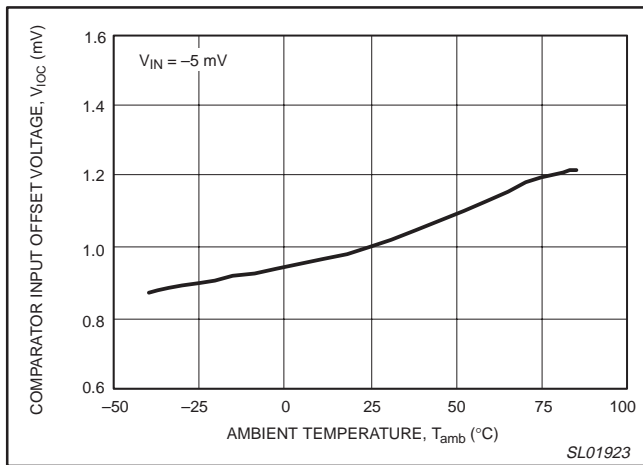

Figure 11. Comparator input offset voltage versus ambient temperature.

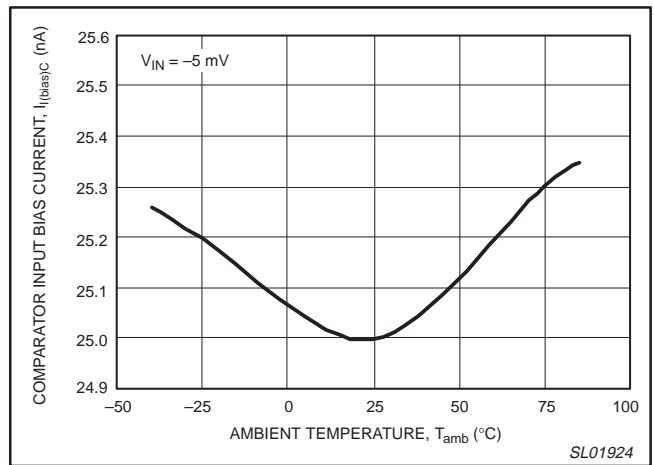

Figure 12. Comparator bias current versus ambient temperature.

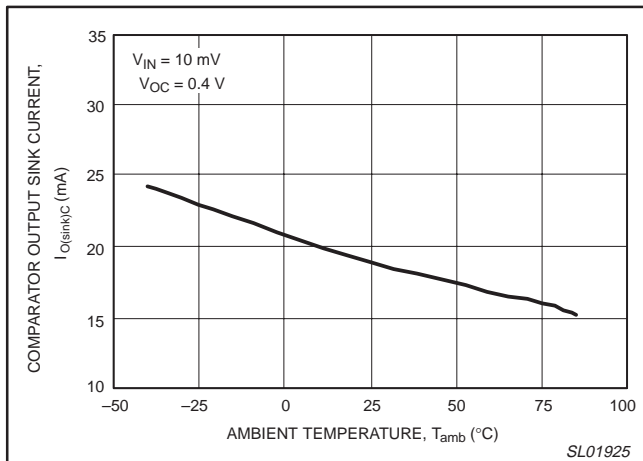

Figure 13. Comparator output sink current versus ambient temperature.

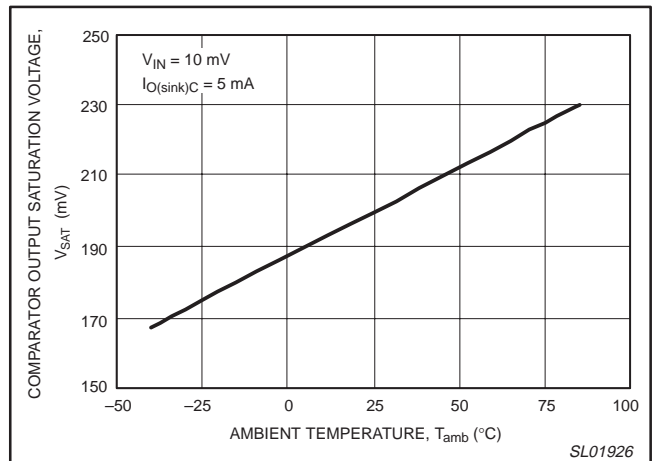

Figure 14. Comparator output saturation voltage versus ambient temperature.

High precision operational amplifier, comparator, and voltage reference

SA58603

TYPICAL CHARACTERIZATION CURVES (continued)

$T_{amb} = 25\text{ }^{\circ}\text{C}$, $V_{CC} = 3\text{ V}$, $V_{IN} = 0\text{ V}$, unless otherwise specified.

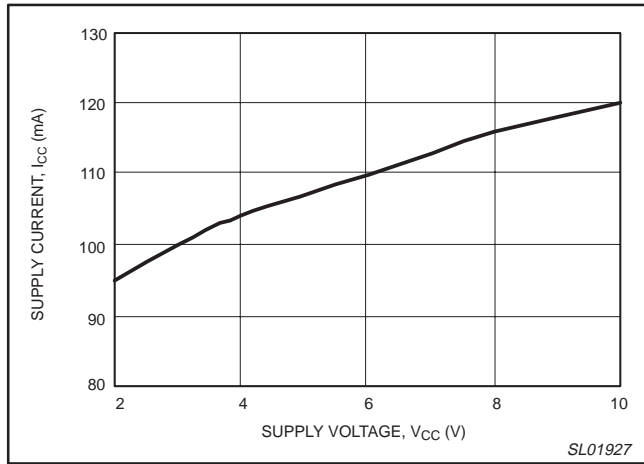

Figure 15. Supply current versus supply voltage.

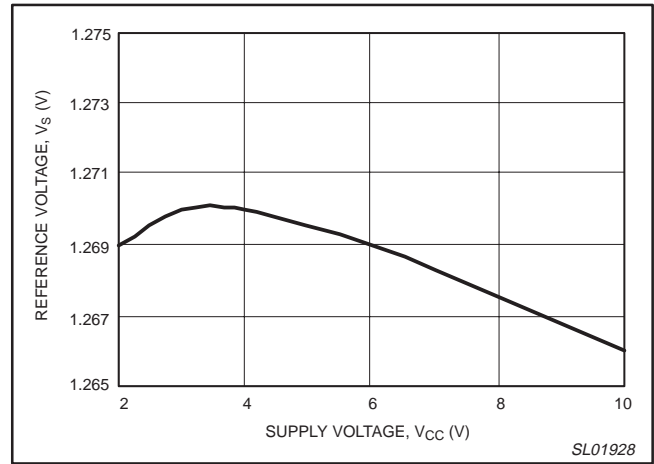

Figure 16. Reference voltage versus supply voltage.

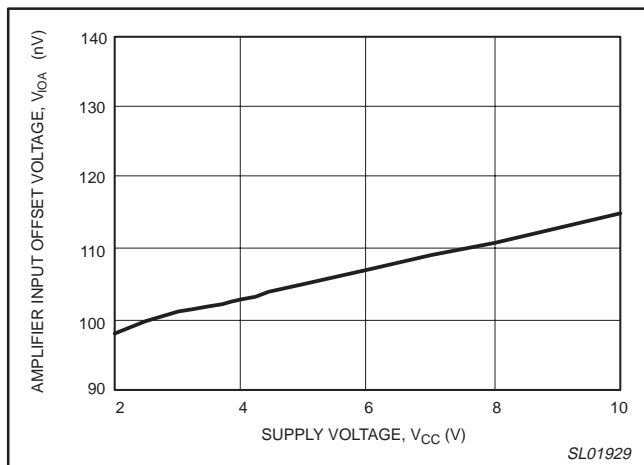

Figure 17. Amplifier input offset voltage versus supply voltage.

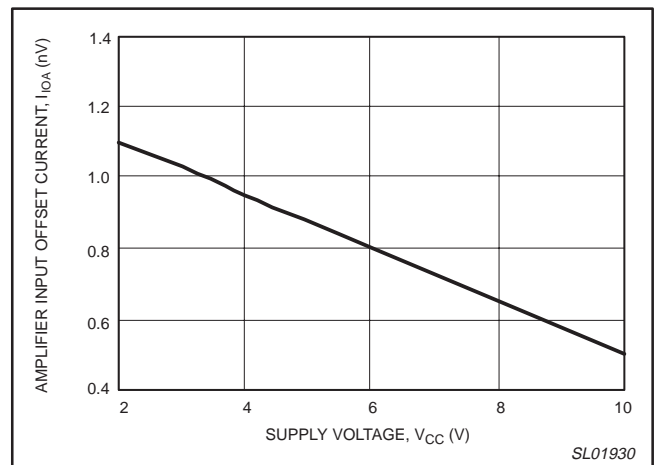

Figure 18. Amplifier input offset current versus supply voltage.

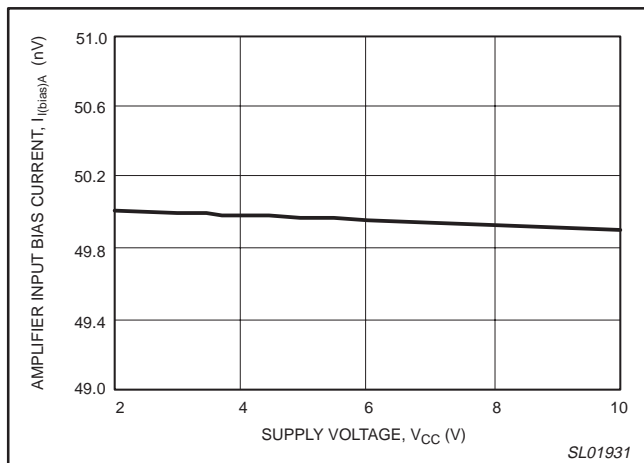

Figure 19. Amplifier input bias current versus supply voltage.

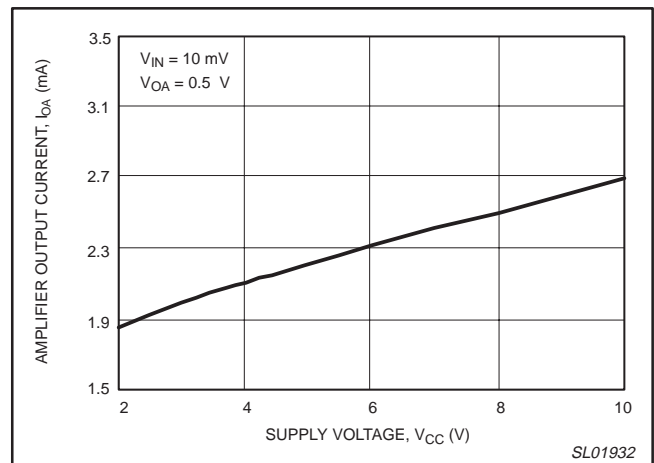

Figure 20. Amplifier output current versus supply voltage.

High precision operational amplifier, comparator, and voltage reference

SA58603

TYPICAL CHARACTERIZATION CURVES (continued)

$T_{amb} = 25\text{ }^{\circ}\text{C}$, $V_{CC} = 3\text{ V}$, $V_{IN} = 0\text{ V}$, unless otherwise specified.

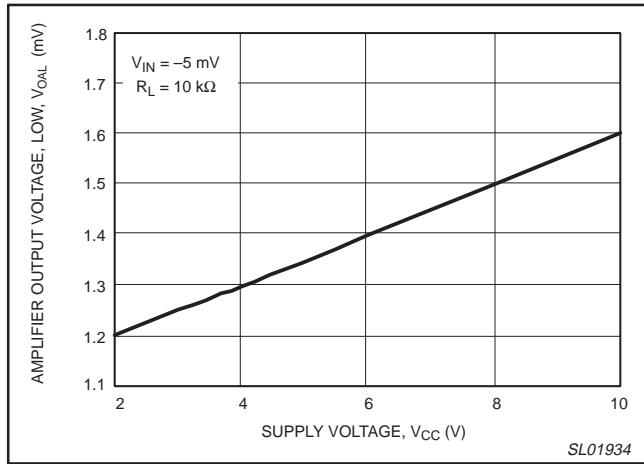

Figure 21. Amplifier output voltage, LOW versus supply voltage.

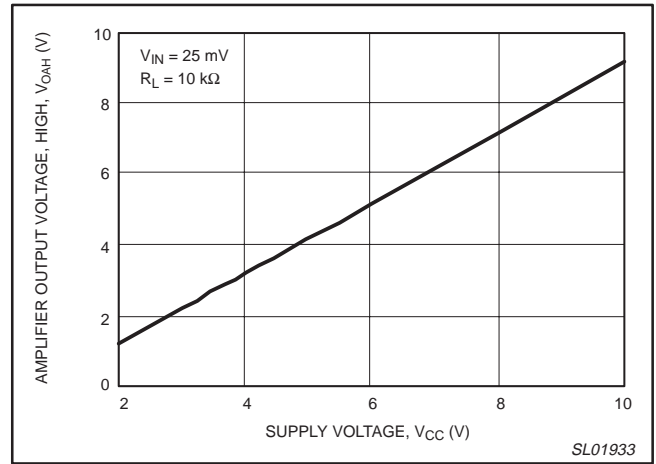

Figure 22. Amplifier output voltage, HIGH versus supply voltage.

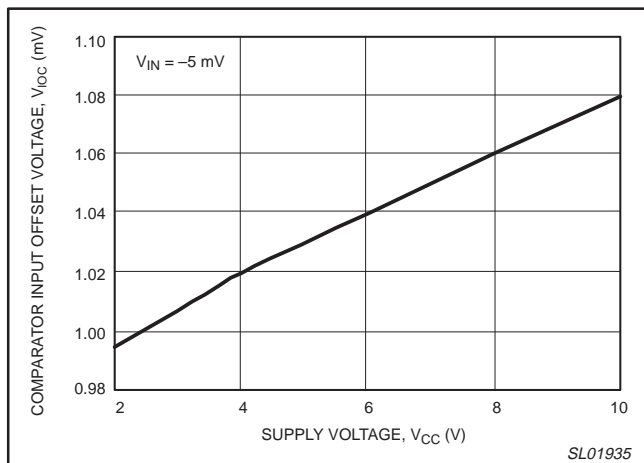

Figure 23. Comparator input offset voltage versus supply voltage.

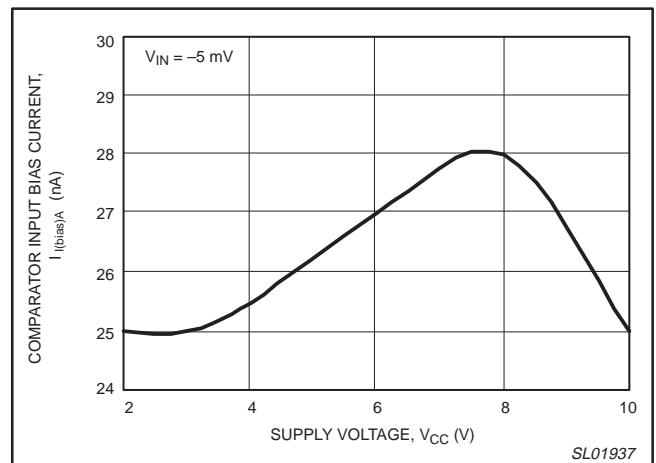

Figure 24. Comparator bias current versus supply voltage.

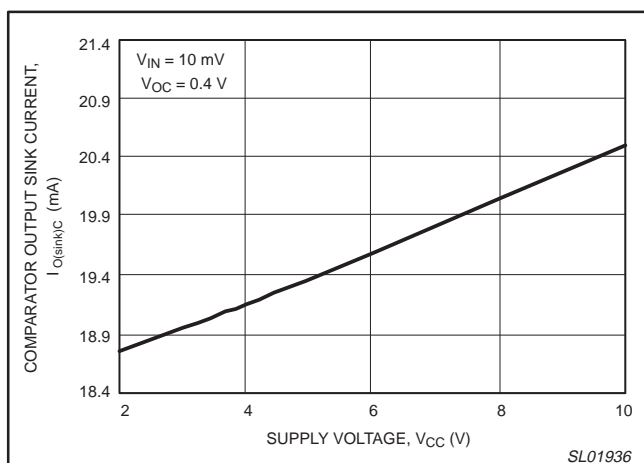

Figure 25. Comparator output sink current versus supply voltage.

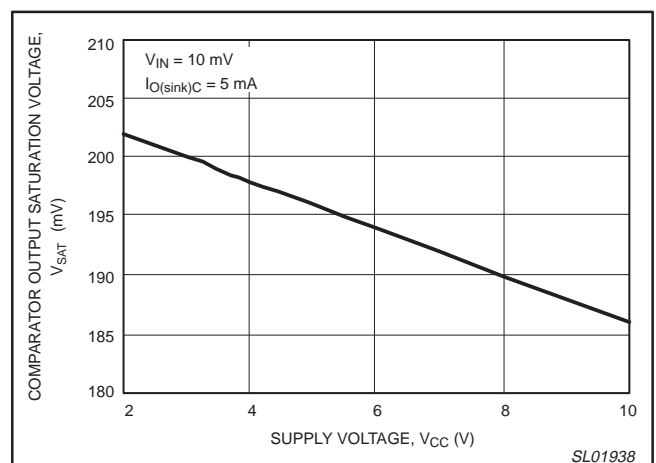

Figure 26. Comparator output saturation voltage versus supply voltage.

High precision operational amplifier, comparator, and voltage reference

SA58603

TYPICAL CHARACTERIZATION CURVES (continued)

$T_{amb} = 25\text{ }^{\circ}\text{C}$, $V_{CC} = 3\text{ V}$, $V_{IN} = 0\text{ V}$, unless otherwise specified.

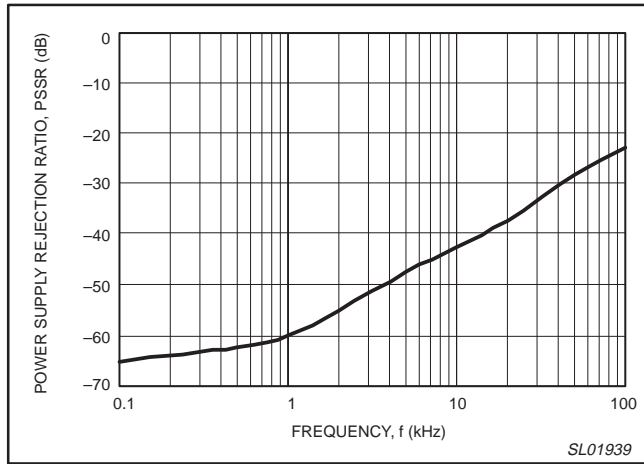

Figure 27. Power supply rejection ratio versus frequency.

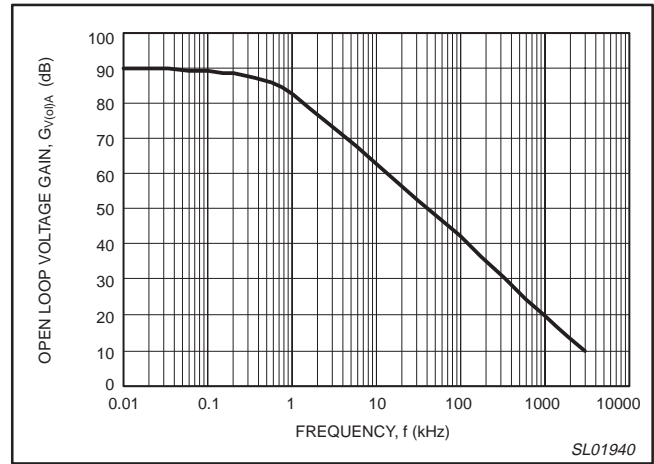

Figure 28. Amplifier open loop gain versus frequency.

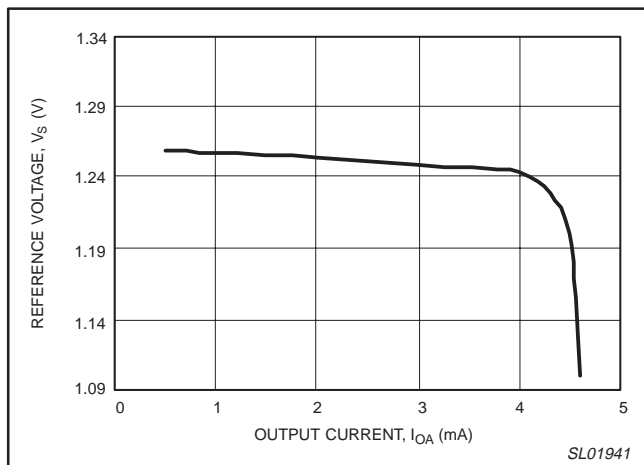

Figure 29. Reference voltage versus output current.

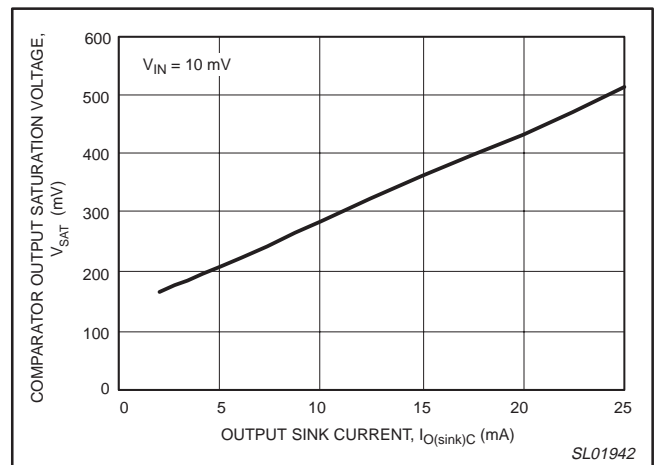

Figure 30. Comparator output saturation voltage versus sink current.

High precision operational amplifier, comparator, and voltage reference

SA58603

APPLICATION INFORMATION

Typical gas pilot detection circuit

Figure 31 shows a typical application of the SA58603 in which the input amplifier is driven by a thermocouple heated by the pilot flame in a water heater or gas burner. The circuit comparator may be programmed to detect when the pilot is out. The IC is operated from a single voltage supply making it capable of battery backup with loss of AC power. It may be operated from a one-cell Lithium battery or two alkaline cells. 10 nF bypass capacitors are placed from V_{CC} and reference voltage output (pin 6) to ground to filter power supply noise and interference from external noise sources.

Selecting external components

Gain

Recommended amplifier gain is 40 dB. The gain is set by the combination of R1, R2, and R3 as shown in the following equations:

$$A_v = \frac{(R3 + R2)}{R3}; A_v \text{ (dB)} = 20 \log (A_v); R3 = R1 \parallel R2$$

For a gain of 40 dB, $A_v = 100 \text{ V/V}$;
if $R2 = 1 \text{ k}\Omega$, then $99 \times R3 = 1 \text{ k}\Omega$; $R3 = 10.1 \Omega$.

$$R3 = \frac{R1 \times R2}{(R1 + R2)}; R3 \times R1 + R3 \times R2 = R1 \times R2;$$

$$R3 \times R2 = R1 (R2 - R3)$$

$$\text{Thus } R1 = \frac{R3 \times R2}{(R2 - R3)} = 10.2 \Omega$$

Comparator output pull-up resistor

The comparator output pull-up resistor is determined by the following formula:

$$R = \frac{(V_{CC} - V_{SAT(max)})}{I_{O(sink)(min)}}$$

where $V_{SAT(max)} = 400 \text{ mV}$, and $I_{O(sink)(min)} = 5 \text{ mA}$.

Comparator threshold voltage

The comparator threshold voltage is determined by R4 and R5. They form a voltage divider from the reference voltage output (V_S, Pin 6) to ground. In the application example, V_{COMP}, the comparator input (COMPIN-, Pin 5) is connected to the junction of R4 and R5. The input level is calculated by following relationship:

$$V_{COMP} = 1.27V \times \frac{R5}{(R4 + R5)}$$

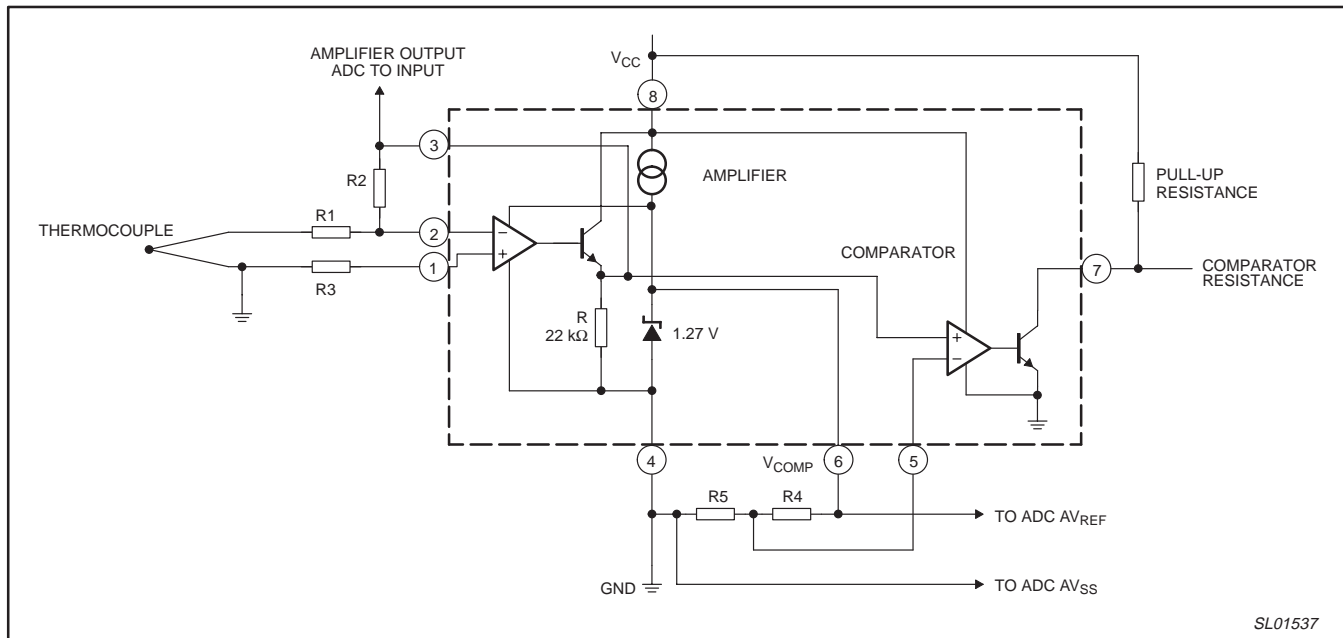

Figure 31. Typical flame detection circuit.

High precision operational amplifier, comparator, and voltage reference

SA58603

PACKING METHOD

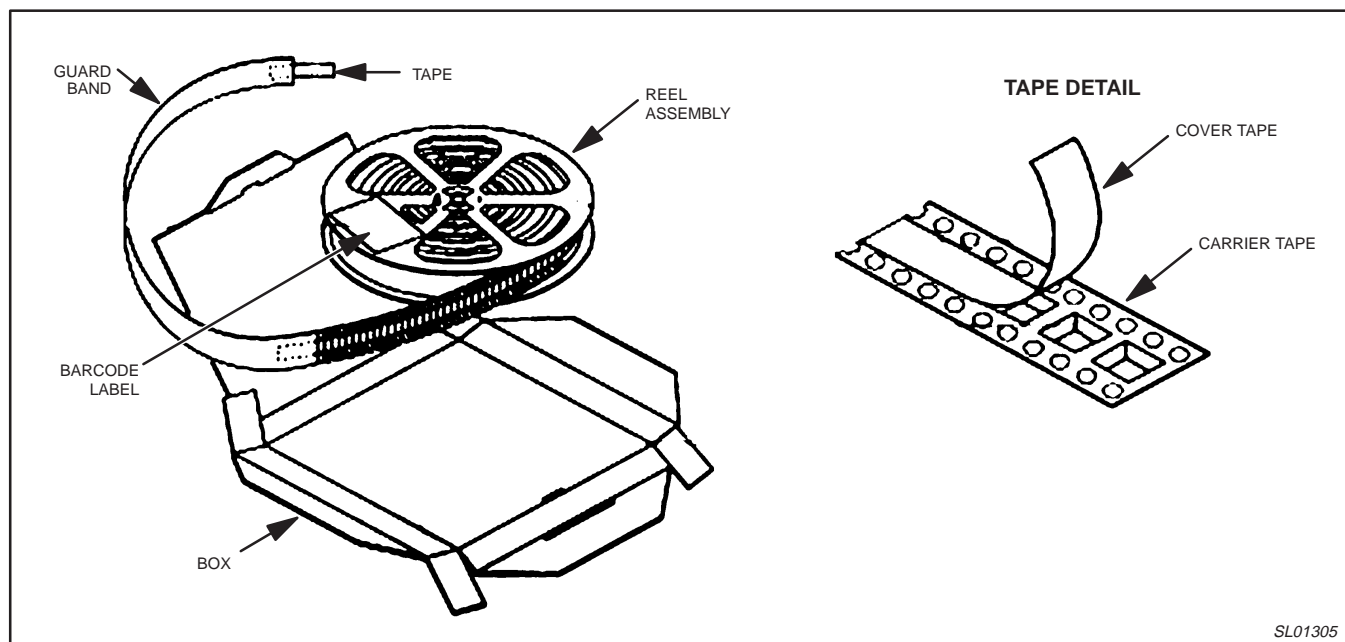
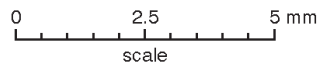
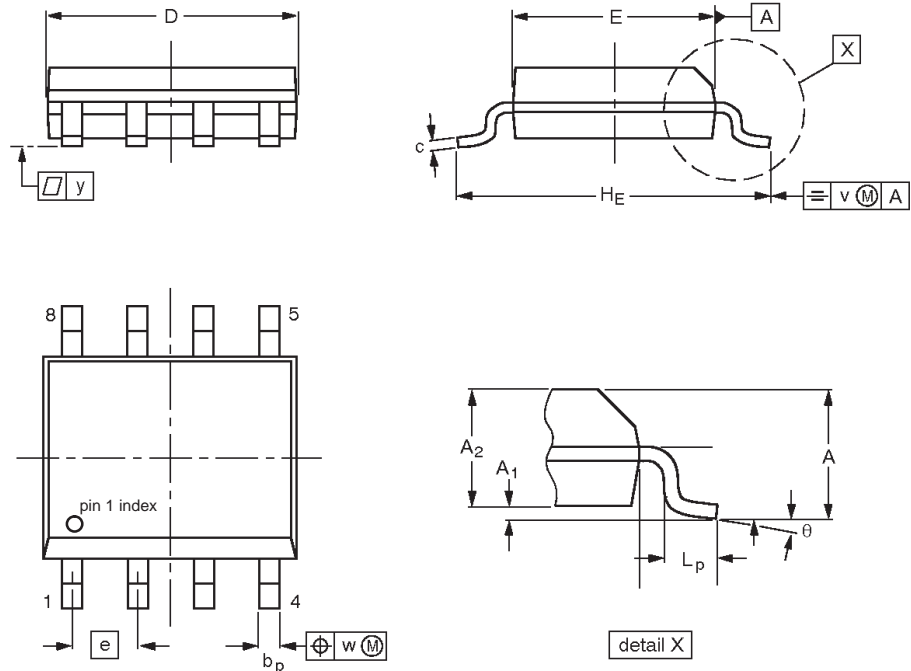

Figure 32. Tape and reel packing method.

High precision operational amplifier, comparator, and voltage reference

SA58603

SO8: plastic small outline package; 8 leads; body width 3.9 mm



DIMENSIONS (inch dimensions are derived from the original mm dimensions)

UNIT	A max.	A ₁	A ₂	B ₂	b _p	c	D ⁽¹⁾	E ⁽²⁾	e	H _E	L _p	y	θ
mm	1.73	0.25 0.10	1.45 1.25	4.95 4.80	0.51 0.33	0.25 0.19	4.95 4.80	4.0 3.8	1.27	6.2 5.8	1.27 0.38	0.076	8° 0°
inches	0.068	0.010 0.004	0.057 0.049	0.189 0.195	0.013 0.020	0.0100 0.0075	0.20 0.19	0.16 0.15	0.050	0.244 0.228	0.050 0.015	0.003	

Notes

1. Plastic or metal protrusions of 0.15 mm maximum per side are not included.
2. Plastic or metal protrusions of 0.25 mm maximum per side are not included.

OUTLINE VERSION	REFERENCES		
	IEC	JEDEC	EIAJ
SO8	076E03	MS-012	

**High precision operational amplifier,
comparator, and voltage reference**

SA58603

REVISION HISTORY

Rev	Date	Description
_2	20021113	Product data; second version (9397 750 10671). Supersedes SA58603_1 of 2001 Oct 03 (9397 750 08955). Engineering Change Notice 853–2289 29151 (date: 20021105). Modifications: <ul style="list-style-type: none">• Add “Typical characterization curves” section.
_1	20011003	Product data; initial version (9397 750 08955). Engineering Change Notice 853–2289 27197 (date: 20011003).

High precision operational amplifier, comparator, and voltage reference

SA58603

Data sheet status

Level	Data sheet status ^[1]	Product status ^{[2] [3]}	Definitions
I	Objective data	Development	This data sheet contains data from the objective specification for product development. Philips Semiconductors reserves the right to change the specification in any manner without notice.
II	Preliminary data	Qualification	This data sheet contains data from the preliminary specification. Supplementary data will be published at a later date. Philips Semiconductors reserves the right to change the specification without notice, in order to improve the design and supply the best possible product.
III	Product data	Production	This data sheet contains data from the product specification. Philips Semiconductors reserves the right to make changes at any time in order to improve the design, manufacturing and supply. Relevant changes will be communicated via a Customer Product/Process Change Notification (CPCN).

[1] Please consult the most recently issued data sheet before initiating or completing a design.

[2] The product status of the device(s) described in this data sheet may have changed since this data sheet was published. The latest information is available on the Internet at URL <http://www.semiconductors.philips.com>.

[3] For data sheets describing multiple type numbers, the highest-level product status determines the data sheet status.

Definitions

Short-form specification — The data in a short-form specification is extracted from a full data sheet with the same type number and title. For detailed information see the relevant data sheet or data handbook.

Limiting values definition — Limiting values given are in accordance with the Absolute Maximum Rating System (IEC 60134). Stress above one or more of the limiting values may cause permanent damage to the device. These are stress ratings only and operation of the device at these or at any other conditions above those given in the Characteristics sections of the specification is not implied. Exposure to limiting values for extended periods may affect device reliability.

Application information — Applications that are described herein for any of these products are for illustrative purposes only. Philips Semiconductors make no representation or warranty that such applications will be suitable for the specified use without further testing or modification.

Disclaimers

Life support — These products are not designed for use in life support appliances, devices, or systems where malfunction of these products can reasonably be expected to result in personal injury. Philips Semiconductors customers using or selling these products for use in such applications do so at their own risk and agree to fully indemnify Philips Semiconductors for any damages resulting from such application.

Right to make changes — Philips Semiconductors reserves the right to make changes in the products—including circuits, standard cells, and/or software—described or contained herein in order to improve design and/or performance. When the product is in full production (status 'Production'), relevant changes will be communicated via a Customer Product/Process Change Notification (CPCN). Philips Semiconductors assumes no responsibility or liability for the use of any of these products, conveys no license or title under any patent, copyright, or mask work right to these products, and makes no representations or warranties that these products are free from patent, copyright, or mask work right infringement, unless otherwise specified.

Contact information

For additional information please visit
<http://www.semiconductors.philips.com>. Fax: +31 40 27 24825

© Koninklijke Philips Electronics N.V. 2002
All rights reserved. Printed in U.S.A.

Date of release: 11-02

For sales offices addresses send e-mail to:
sales.addresses@www.semiconductors.philips.com

Document order number:

9397 750 10671

Let's make things better.