

## DESCRIPTION

MORB51 Series are red LED lamp with 5mm diameter epoxy package.

MRB51C is red chip with red transparent lens.

MB51D is red chip with red diffused lens.

MRB51T is red chip with clear transparent lens.

MRB51W is red chip with clear diffused lens.

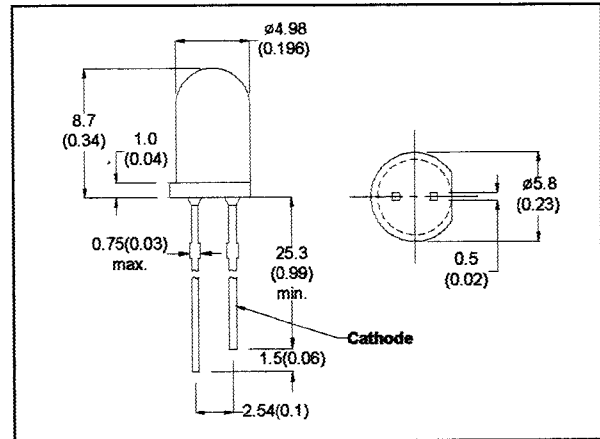

- All Dimension in mm (inch)
- No Scale
- Tol : +/- 0.3mm

## ABSOLUTE MAXIMUM RATINGS

Power Dissipation @ Ta=25°C	80mW
Forward Current, DC (IF)	40mA
Reverse Voltage	5V
Operating & Storage Temperature Range	-55 to +100°C
Lead Soldering Temperature (1/16" from body)	260°C for 5 sec.

## ELECTRO-OPTICAL CHARACTERISTICS (Ta=25°C)

PARAMETER	SYMBOL	MRB51C	MRB51D	MRB51T	MRB51W	UNIT	CONDITIONS
Forward Voltage	MAX	VF	2.0	2.0	2.0	V	IF=20mA
Reverse Breakdown Voltage	MIN	BVR	5	5	5	V	IR=100 μA
Luminous Intensity	MIN	IV	8	3	8	mcd	IF=20mA
	TYP		12	4.5	12	mcd	
Peak Wavelength	TYP	λp	660	660	660	nm	IF=20mA
Spectral Line Half Width	TYP	Δλ	20	20	20	nm	IF=20mA

MRB51D

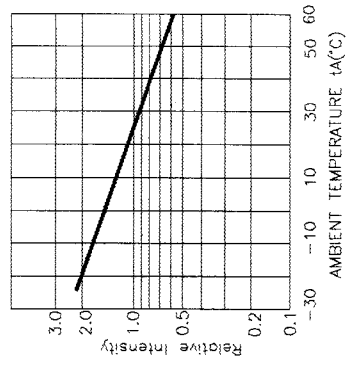
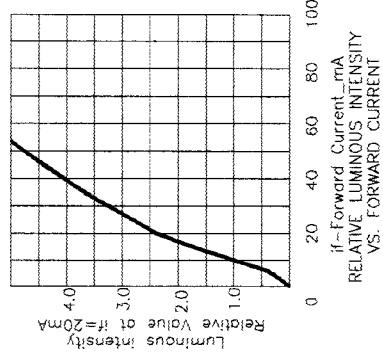
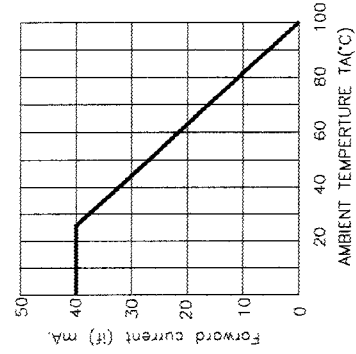
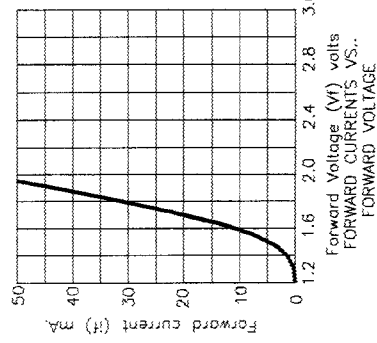
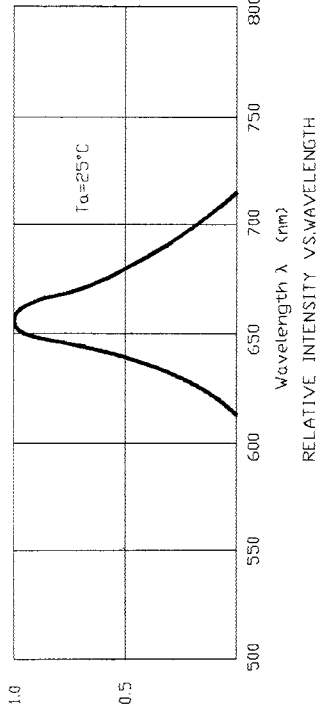
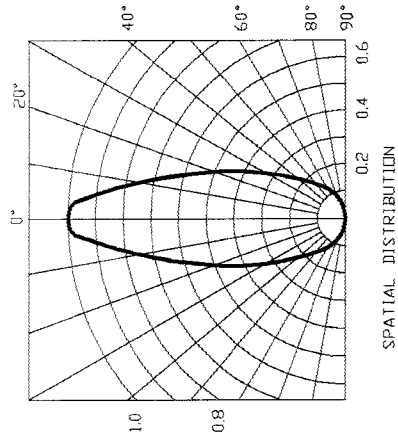

Rev. A