



# LA1862M

## Single-chip Tuner System for Car Stereo

### Overview

The LA1862M is a single-chip car stereo FM IF/NC/MPX tuner IC which offers improved IF stability and S-meter characteristics, compared with the LA1861M.

The LA1862M makes the design of high-performance FM tuners at low cost easy.

### Functions

- IF amplifier
- Peak detector
- AF preamplifier
- AFC output
- S-meter driver
- Soft mute circuit
- IF buffer output
- Noise canceller
- Adjustment-free VCO
- Pilot signal canceller
- SNC High-cut control (HCC)

### Features

- Pin compatible with the LA1861M
- Improved I/O S-meter characteristics
- Excellent sound quality at low input levels
- Easy adjustment of muting characteristics
- Because this device has a 36-pin flat package, it requires few external components and offers excellent cost performance.

### Specifications

#### Maximum Ratings at $T_a = 25^\circ\text{C}$

Parameter	Symbol	Conditions	Ratings	Unit
Maximum supply voltage	$V_{CC}$ max	Pin 8	10	V
Allowable power dissipation	$P_d$ max	$T_a = 25^\circ\text{C}$	720	mW
Input voltage	$V_{IN}$ IF	Pin 36-35 (IF input)	$\pm 0.7$	Vp-p
	$V_{IN}$ MPX	Pin 26 (NC-MPX input)	1.0	Vrms
Input current	$I_L$ max	Pin 25 (stereo lamp drive current)	20	mA
Output current	$I_{SD}$ max	Pin 5 (SD output)	1.0	mA
Operating temperature	$T_{opr}$		-30 to +80	$^\circ\text{C}$
Storage temperature	$T_{stg}$		-40 to +150	$^\circ\text{C}$

### Package Dimensions

unit : mm

#### 3129-MFP36S

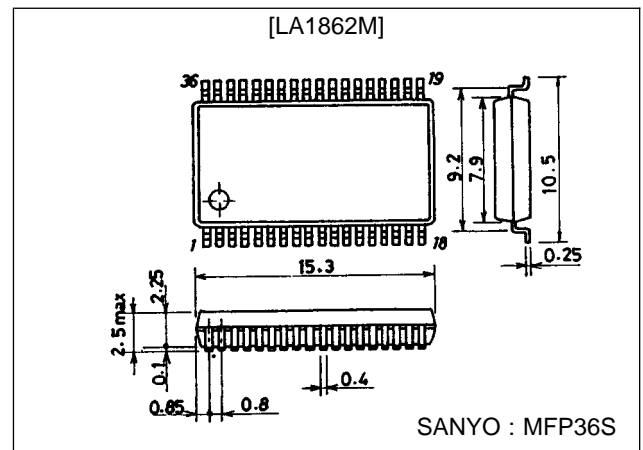

## LA1862M

### Operating Conditions at Ta = 25°C

Parameter	Symbol	Conditions	Ratings	Unit
Recommended supply voltage	V <sub>CC</sub>		8.5	V
Operating supply voltage range	V <sub>CC op</sub>		7.5 to 10	V

### Operating Characteristics at Ta = 25°C, V<sub>CC</sub> = 8.5 V, f = 10.7 MHz, unless otherwise noted SW-1 is off.

Parameter	Symbol	Conditions	min	typ	max	Unit
Quiescent current	I <sub>CCO</sub>	No input signal		45	70	mA
Current drain	I <sub>CC-100</sub>	V <sub>IN</sub> = 100 dBμ		47	72	mA
Demodulator output voltage	V <sub>O</sub>	V <sub>IN</sub> = 100 dBμ, f = 1 kHz, 100% modulation, pin 15 output	225	350	495	mVrms
Total harmonic distortion	THD 1	Mono, V <sub>IN</sub> = 100 dBμ, f = 1 kHz, 100% modulation, pin 15 output		0.3	1.2	%
	THD 2	Stereo (L + R), V <sub>IN</sub> = 100 dBμ, f = 1 kHz, 100% modulation, pin 15 output		0.3	1.2	%
Signal-to-noise ratio	S/N	V <sub>IN</sub> = 100 dBμ, f = 1 kHz, 100% modulation	64	71		dB
Input limiting voltage	V <sub>IN lim</sub>	V <sub>IN</sub> = 100 dBμ reference, 3 dB audio output attenuation, IF input level, soft muting ON	32	41	50	dBμ
Muting attenuation (1)	Mute Att	V <sub>5</sub> = 5 V, V <sub>IN</sub> = 100 dBμ, f = 1 kHz, 100% modulation	21	25	29	dB
Muting attenuation (2)	Mute Att	V <sub>5</sub> = 2 V, V <sub>IN</sub> = 100 dBμ, f = 1 kHz, 100% modulation	5	10	15	dB
Muting bandwidth	BW <sub>Mute</sub>	V <sub>IN</sub> = 100 dBμ, V <sub>5</sub> = 2 V	135	200	305	kHz
AM rejection ratio	AMR	V <sub>IN</sub> = 100 dBμ, 400 Hz, 100% modulated FM carrier. 1 kHz, 30% modulated AM interference signal	47	60		dB
Muting drive output voltage	V <sub>5-0</sub>	No input signal	3.5	4.7		V
	V <sub>5-100</sub>	V <sub>IN</sub> = 100 dBμ		0	0.3	
S-meter output voltage	V <sub>1-0</sub>	No input signal		0.1	0.5	V
	V <sub>1-50</sub>	V <sub>IN</sub> = 50 dBμ	1.1	1.9	2.7	V
	V <sub>1-100</sub>	V <sub>IN</sub> = 100 dBμ	5.4	6.4	7.4	V
IF COUNT output sensitivity		IF input level at IF COUNT ON. SW-1 is ON.	44	53	62	dBμ
IF buffer output voltage	V <sub>IF-ON</sub>	V <sub>IN</sub> = 100 dBμ. SW-1 is ON.	200	300	480	mVrms
Input impedance	Z <sub>in</sub>	f = 1 kHz		20		kΩ
Output noise voltage	V <sub>NO</sub>	Pin 26 connected to ground		27		μV
Gate time	t <sub>gate</sub>	V <sub>IN</sub> = 100 mVp-p, 1 μs pulsewidth, f = 1 kHz	13	23	35	μs
Noise sensitivity	SN	V <sub>IN</sub> = 1 μs pulsewidth, f = 1 kHz			35	mVp-o
Channel separation	Sep	f = 1 kHz, 90% L+R signal modulation. 10% pilot signal modulation, IHF bandpass filter.	36	50		dB
Stereo indicator threshold level		Pilot signal level when the LED turns ON.	1.0	2.5	5.0	%
Stereo indicator hysteresis	hy	LED ON level - LED OFF level		3.2	6.5	dB
Capture range	C.R	CR =   (f - 456)/456 x 100		±1.2		%
SCA rejection ratio	SCA rej	90% L + R signal modulation. 10% pilot signal modulation. 67 kHz, 10% modulated SCA signal		75		dB
SNC output attenuation	Att <sub>SNC</sub>	V <sub>14</sub> = 0.6 V, 90% L - R signal modulation. 10% pilot signal modulation	-12.0	-7.5	-3.0	dB
SNC output voltage	V <sub>Osub</sub>	V <sub>14</sub> = 0.1 V, 90% L - R signal modulation. 10% pilot signal modulation			5	mV
High-out control attenuation	Att <sub>HCC1</sub>	V <sub>13</sub> = 0.6 V, 90% L + R signal modulation. 10% pilot signal modulation	-15	-5	0	dB
	Att <sub>HCC2</sub>	V = 1.1 V, 90% L + R signal modulation. 10% pilot signal modulation	-2.0		0	dB
Ripple rejection	R <sub>r</sub>	f = 50 Hz, V = 100 mVrms		27		dB
Channel balance	CB	Pin 15 output - pin 16 output		0	1.5	dB
Pilot signal attenuation		Left channel adjusted and measured DIN audio filter. See Note.	15	22		dB
Stereo indicator LED current		Minimum stereo drive current	1.0			mA
Pin 25 saturation voltage		I <sub>L</sub> = 10 mA		1.0		V

Note: When a filter is not specified, connect an IHF bandpass filter to the MPX outputs.

# LA1862M

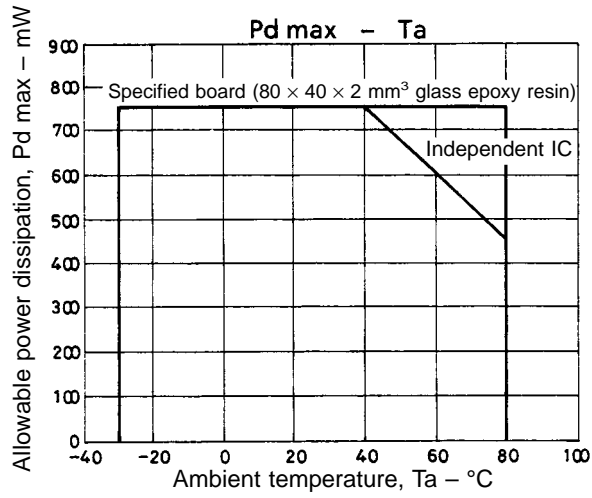

## Test Circuit

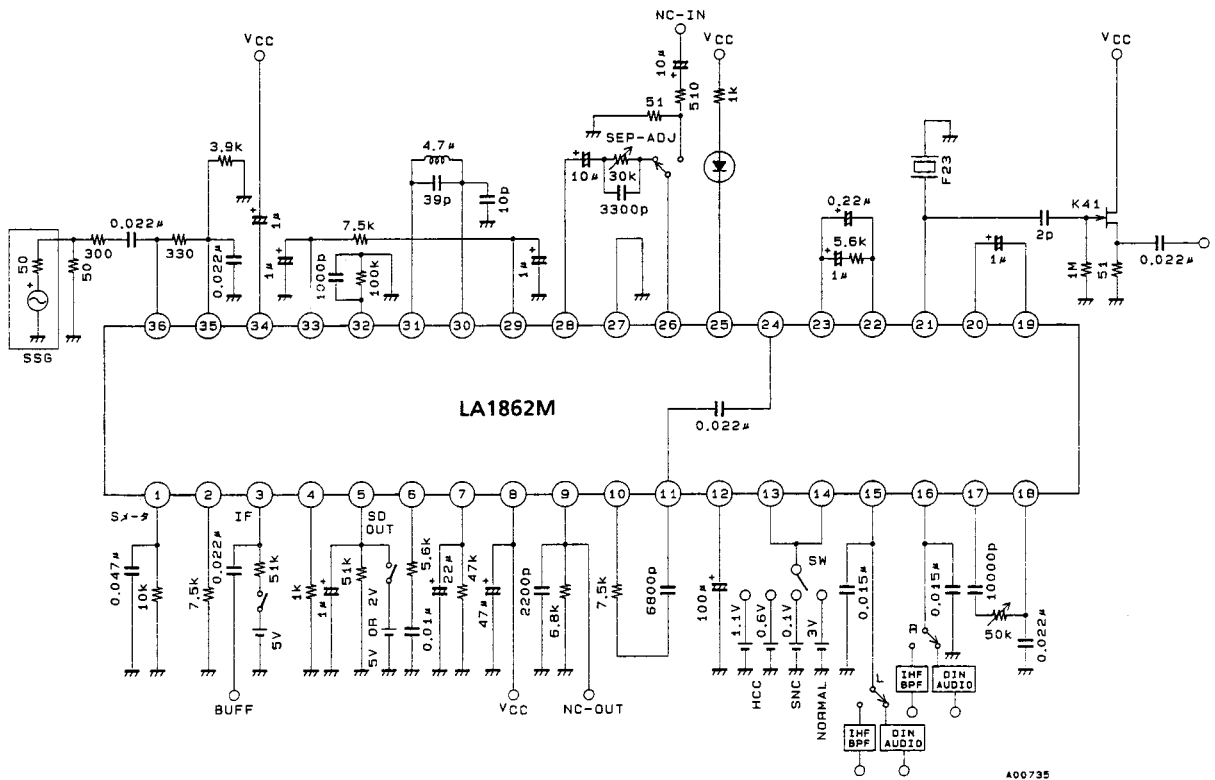

Unit (resistance: Ω, capacitance: F)

## LA1862M

### Pin Description

Pin No.	Description
1	S-meter output
2	IF buffer sensitivity control
3	IF buffer output
4	Muting threshold control
5	Muting drive control output
6	Noise sensitivity control
7	Noise AGC sensitivity control
8	Supply voltage ( $V_{CC}$ )
9	Gate time control output
10	Peak hold network connection
11	Lowpass filter output
12	High-cut attenuation control
13	High-cut control input
14	SNC control input
15	MPX left-channel audio output
16	MPX right-channel audio output
17	Pilot cancel signal input
18	Pilot cancel signal output
19	Pilot detector capacitor connection 1
20	Pilot detector capacitor connection 2
21	External VCO (F23) connection
22	Phase detector network connection 1
23	Phase detector network connection 2
24	PLL input
25	Stereo indicator LED driver output
26	Noise canceller input
27	Ground
28	Audio muting amplifier output (AF output)
29	AFC output
30	Peak detector input
31	IF signal output
32	Muting attenuation control
33	Voltage reference output
34	Pilot signal canceller detector
35	IF input
36	IF bypass input

Sample Application Circuit

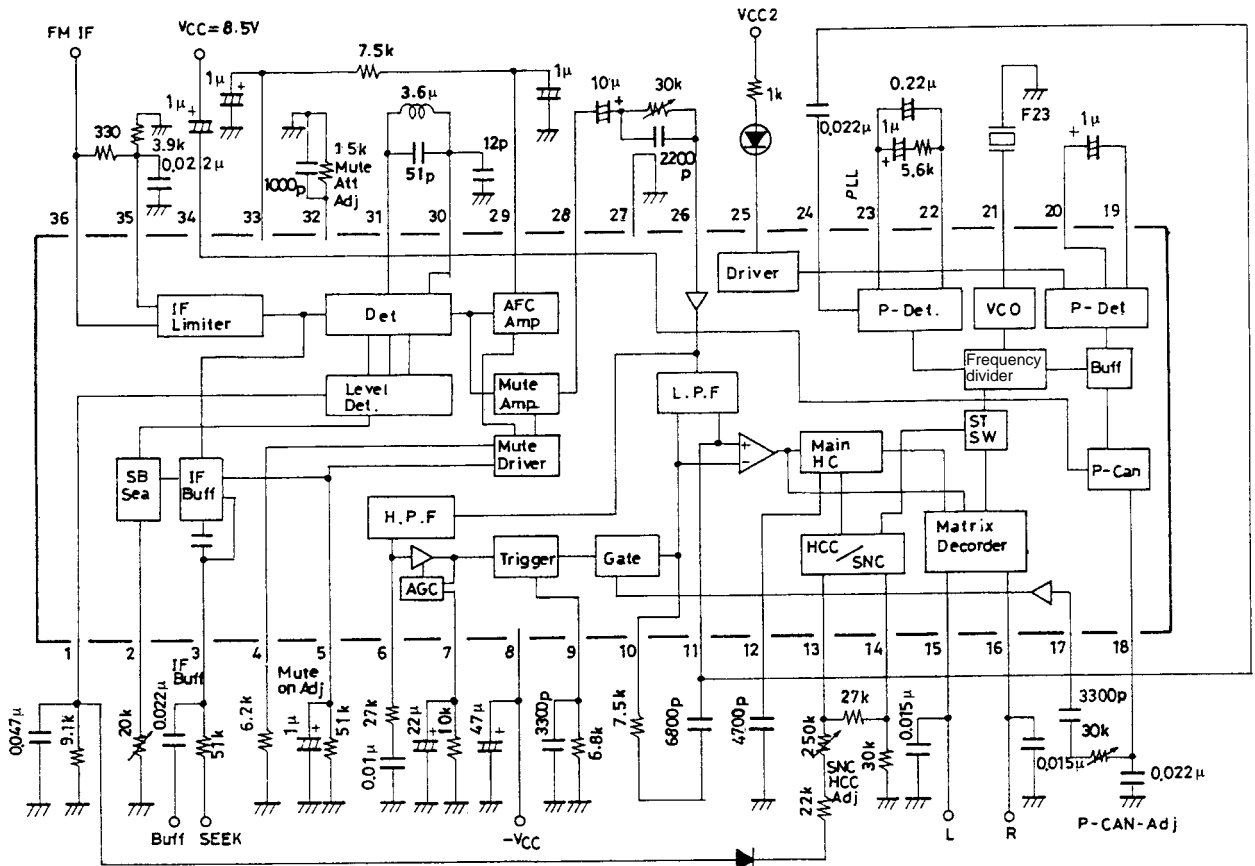

Unit (resistance: Ω, capacitance: F)

PCB Pattern

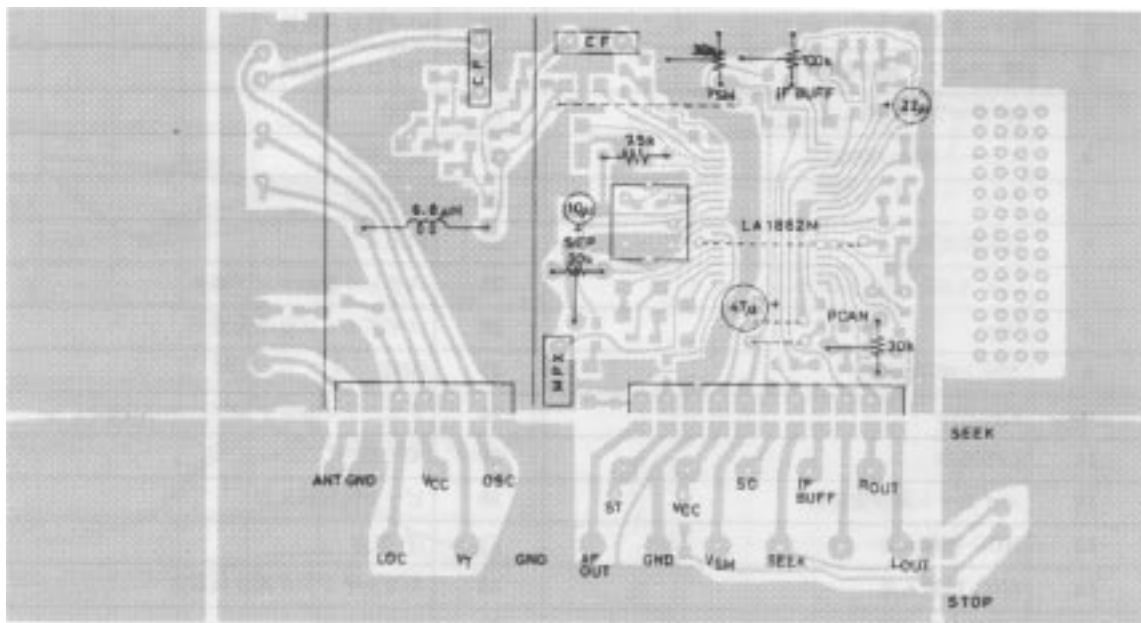

Unit (resistance: Ω, capacitance: F)

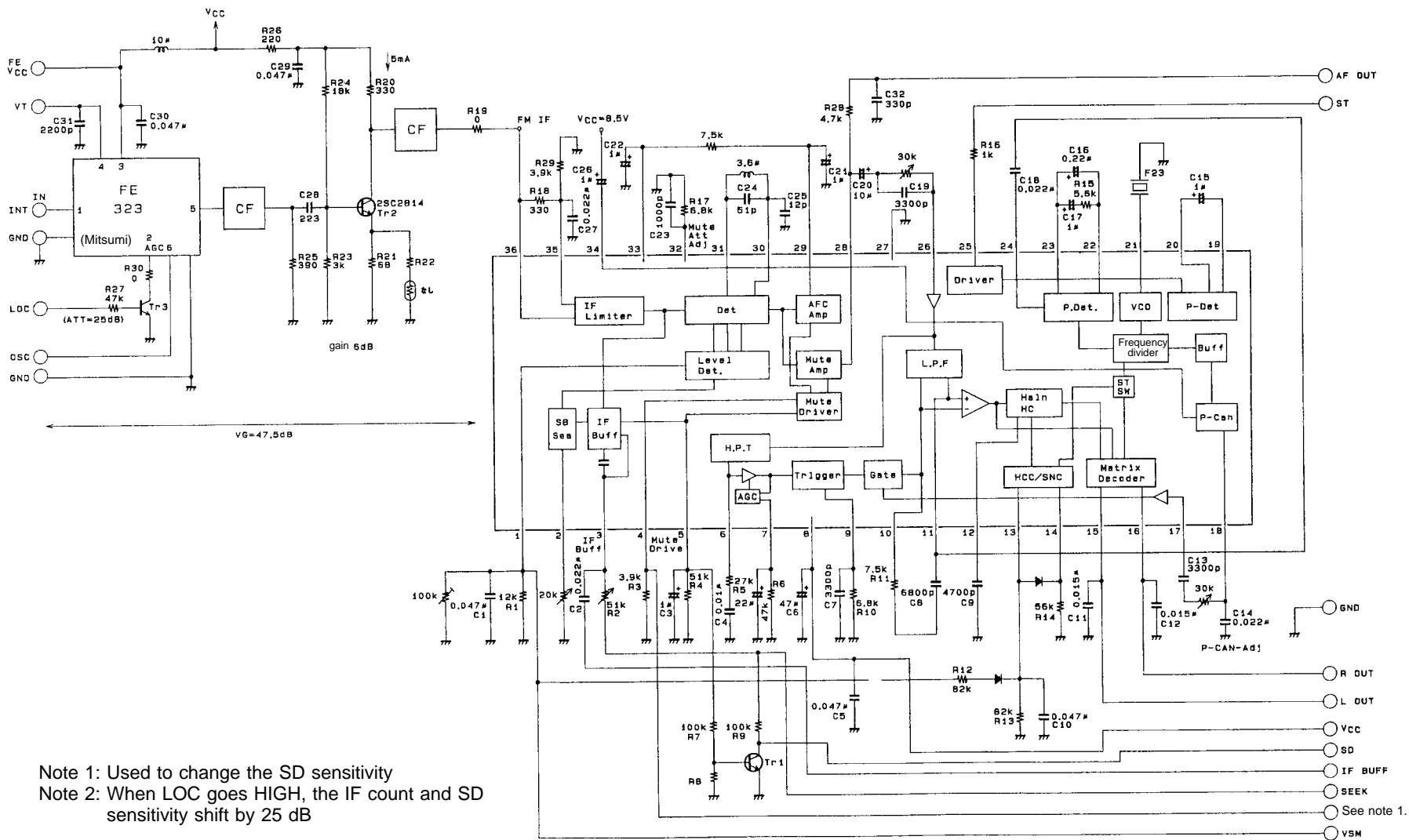

Note 1: Used to change the SD sensitivity  
 Note 2: When LOC goes HIGH, the IF count and SD sensitivity shift by 25 dB

400736

Unit (resistance: Ω, capacitance: F)

# LA1862M

## Pin Functions

Pin No.	Function	Equivalent circuit	Remarks
1	S-meter output		Current-drive waveform S-meter circuit
2	IF buffer ON adjust		
3	IF buffer output		Control signal: SEEK when HIGH ( $V_{DD}$ ) STOP when LOW (GND) Pin 3 should be left open if not using the IF count
4	Mute adjust		

Continued on next page.

# LA1862M

Continued from preceding page.

Pin No.	Function	Equivalent circuit	Remarks
5	Mute drive		
6	Noise sensitivity adjust		
7	Noise AGC		
9	Gate time adjust		<p>Pin 9 voltage 1.4V</p>
10	Memory circuit		
11	LPF output		
17	Pilot cancel signal input		

Continued on next page.



# LA1862M

Continued from preceding page.

Pin No.	Function	Equivalent circuit	Remarks
12	High-cut capacitive coupling		High-cut frequency set pin
13	HCC control input		
14	SNC control input		
15	MPX outputs		Output R = 3.3 kΩ Load R built-in
16			

Continued on next page.

# LA1862M

Continued from preceding page.

Pin No.	Function	Equivalent circuit	Remarks
18	Pilot cancel signal output		
34	Pilot cancel signal detector		
19	Pilot detectors		
20			
21	VCO		
22	Phase detectors		
23			

Continued on next page.

# LA1862M

Continued from preceding page.

Pin No.	Function	Equivalent circuit	Remarks
24	PLL input		
25	ST indicator		ST indicator Mono when HIGH and stereo when LOW
26	Noise canceller input		
28	Muting circuit output		pin 28: Output impedance 50 Ω
32	Muting attenuation adjust		

Continued on next page.

# LA1862M

Continued from preceding page.

Pin No.	Function	Equivalent circuit	Remarks
29	AFC output		
30	Peak detector input		
31	Constant voltage output		
33	Constant voltage circuit		
35	IF input		
36	IF bypass		

**IF Block**

**Obtaining Stable Characteristics**

1. Pin 36 is the IF input; pin 35, the IF bypass. Connect a 330 Ω resistor between them for ceramic filter matching.
2. Position the capacitor between the IF bypass (pin 35) and the ground pattern so as to maximize AM rejection.
3. Provide separate ground pattern islands for the IF input and detection circuits, as sharing the same island reduces stability.
4. Position the IF input and detector coil as far apart as possible, as proximity reduces stability and introduces beat noise in the output.

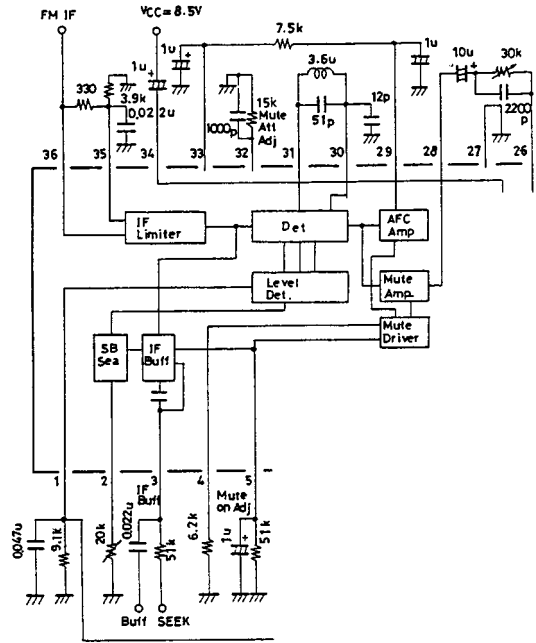

Unit (resistance: Ω, capacitance: F)

**S-meter Output  $V_{SM}$**

1. Pin 1 is the field strength indicator (or “S-meter”) output. Its current-driven circuit uses an external resistance to adjust the slopes of the I/O characteristics curves.
2. The S-meter output is internally connected to the soft muting and IF buffer blocks for use as a control signal for the soft muting drive and IF count buffer.
3. The point at which the input produces an S-meter output depends on the front end (FE) and interstage amplifier gains.
4. Too large a front end gain produces floating S-meter output even when there is no input. Either use a smaller load resistance on pin 1 or reduce the front end gain so that the output with no load does not exceed 0.5 V.
5. The S-meter output circuit has a dynamic range of approximately 80 dB, but this is limited by the front end noise component and broadband AGC circuit.

**Soft Muting**

1. The soft muting circuit operates in response to the S-meter output voltage. The amount of muting is related to the pin 5 output voltage.
2. There are two mechanisms for adjusting the soft muting I/O characteristic curve:
  - a. Start point for muting: Resistance attached to pin 4
  - b. Attenuation for muting: Resistance attached to pin 32

\*Note that the resistance attached to pin 1 also affects the curve.
3. The soft muting circuit automatically varies the amount of muting in response to the IF input. In the absence of front end broadband AGC effects, the time constant of the RC circuit between pins 1 and 5 determines the response.

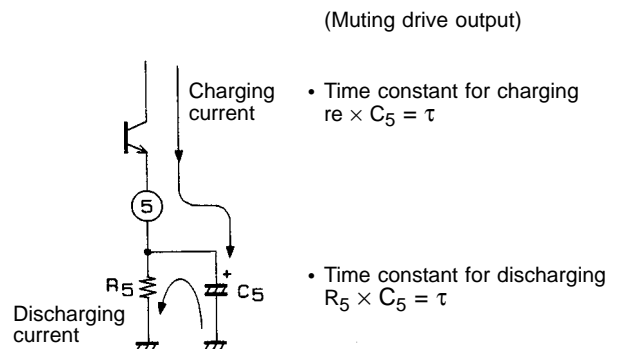

A01170

**Band Muting**

1. Band muting uses the detector’s S-curve. The band-width depends on the resistance between pins 29 and 33. Select this value to match the needs of the destination market.
2. Keep in mind that changing the detector coil or tuning capacity Q changes the slope of the S-curve and hence the bandwidth.
3. The attenuation muting depends on the resistance connected to pin 32.
4. The muting transient response depends on the resistance between pins 29 and 33, the capacitance at pin 29, and the time constant for the RC circuit at pin 5.

**Detector**

1. This IC uses a peak differential detector.
2. To adjust the detector coil, use the built-in automatic frequency circuit (AFC) and rotate the coil core until the voltage drop between pins 29 and 33 is 0 V.
3. Zeroing the AFC and minimizing the total harmonic distortion requires adjusting the capacitance between pin 30 and ground. Note that stray circuit board capacitance can affect this capacitance value.
4. The level of demodulation that is output depends on the inductance of the coil between pins 30 and 31, tuning capacity Q and the capacitor size. Note that although raising Q increases the slope of the S-curve and thus the demodulation output, it does so at the risk of increasing distortion.
5. If the destination market is Europe, increasing the slope of the S-curve helps reduce interference from neighboring channels.

**IF Count Buffer**

1. Pin 3 is the IF count buffer output. To activate the IF count circuit, apply a 5 V input to pin 3 through a 51 kΩ resistor.
2. The resistor connected to pin 2 determines the IF count buffer output sensitivity (seek stop sensitivity).
3. Leave pins 2 and 3 open if the IF count buffer is not used.
4. The largest time constant among those for the following pins determines the transient response characteristic of the IF count buffer.

Pin 1: the S-meter output, pin 4: the start of muting, pin 5: the muting drive output and pin 29: the AFC output.

IF count system block diagram

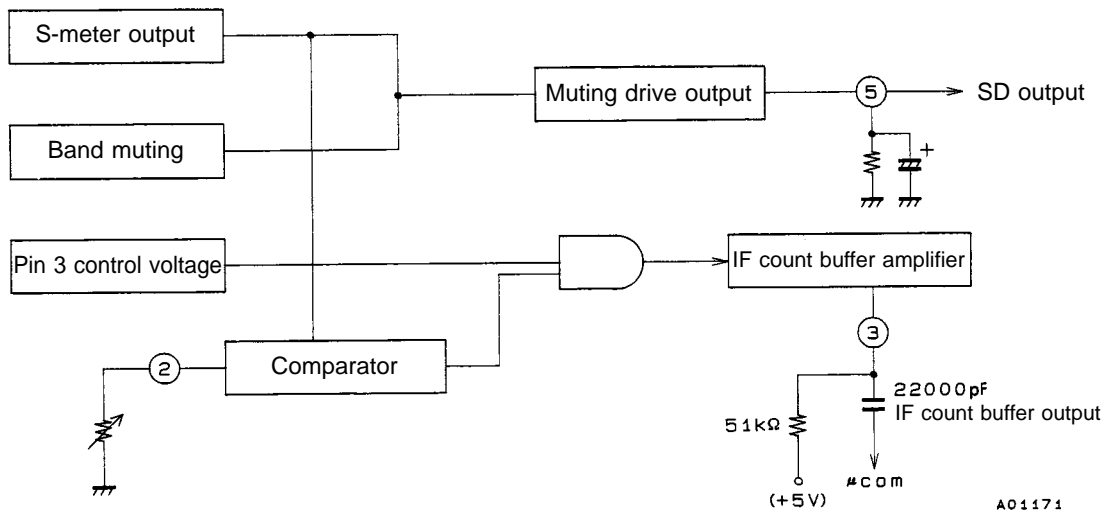

The logical AND of the S-meter output and pin 3 control voltage generates the output 10.7 MHz IF count signal.

**SD Output**

1. To obtain SD output, attach an external NPN transistor to pin 5 as shown in the following figure.
2. The resistor connected between the base and ground is for adjusting the SD sensitivity.
3. The transient response characteristic of the resulting SD circuit on pin 5 is, like that for the IF count buffer, determined by the time constants for pins 1, 4, 5 and 29. Raising the seek speed requires decreasing the time constants. Decreasing them too far, however, reduces muting transient response and risks introducing beat noise and other distortion.

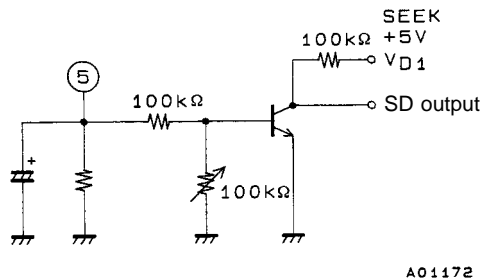

4. The following figure illustrates one possible circuit design using both the IF count buffer and the SD output circuit.

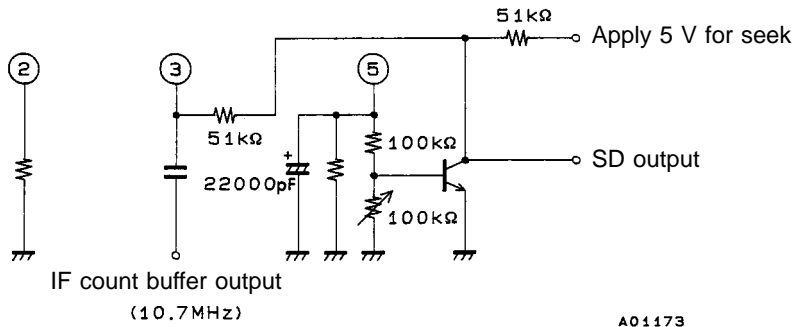

**Noise Canceller Block**

1. The resistor and capacitor connected to pin 6 determine the noise canceller sensitivity.
2. The resistor and capacitor connected to pin 7 determine the noise AGC.
3. Pin 9 is the gate trigger output. The resistor and capacitor connected to pin 9 determine the length of time that the gate is open.
4. The resistor and capacitor connected to pins 10 and 11 are for holding the input signal level when the noise canceller gate operates. The storage time depends on the time that the gate is open. The time constant for the RC circuit on pins 10 and 11 must, therefore, be such that the output retention signal level does not drop during this interval.

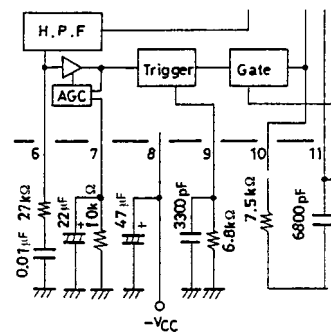

Noise canceller input waveform

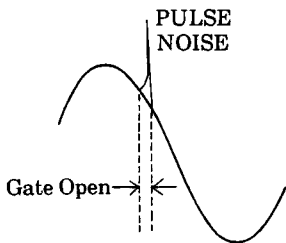

Noise canceller output waveform

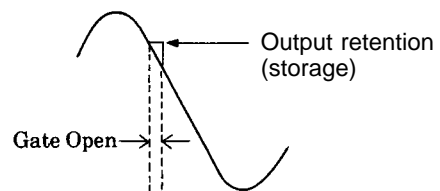

5. Pin 26 is the noise canceller input. An appropriate input level is 250 mVrms for 100% dev and fm = 1 kHz. Excessive input can exceed the noise canceller dynamic range, increasing the THD. Insufficient input, on the other hand, lowers the signal-to-noise ratio and reduces pilot lamp sensitivity.





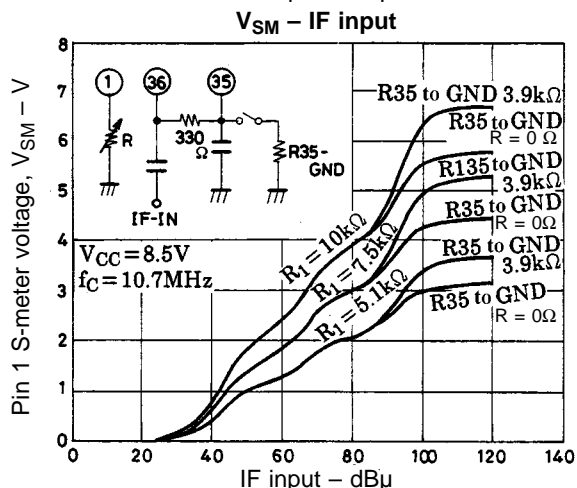
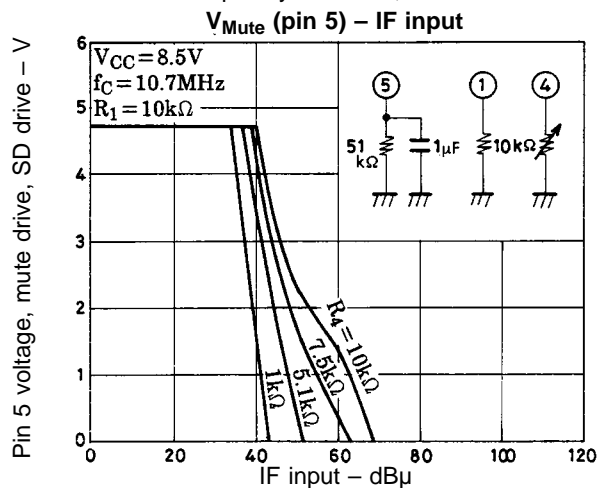
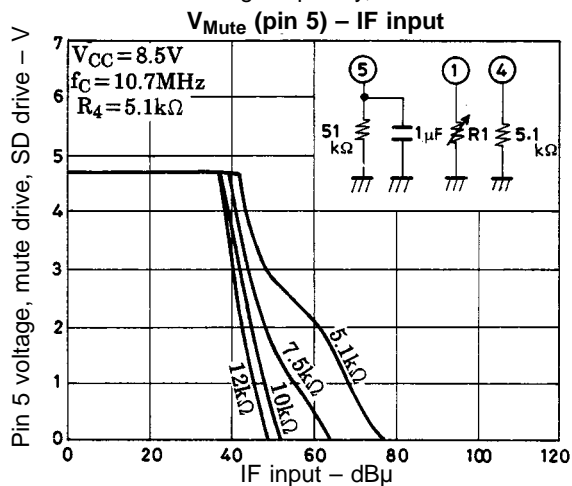
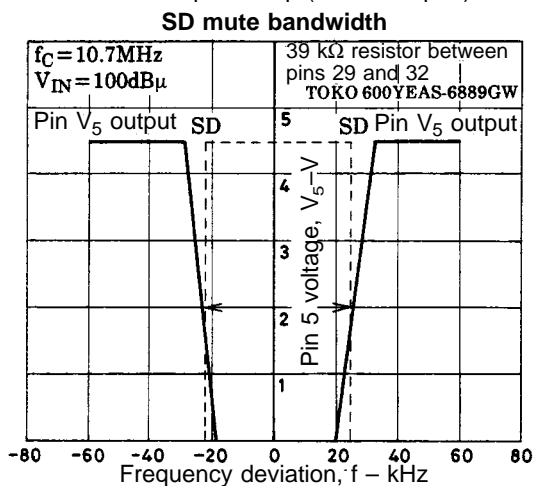
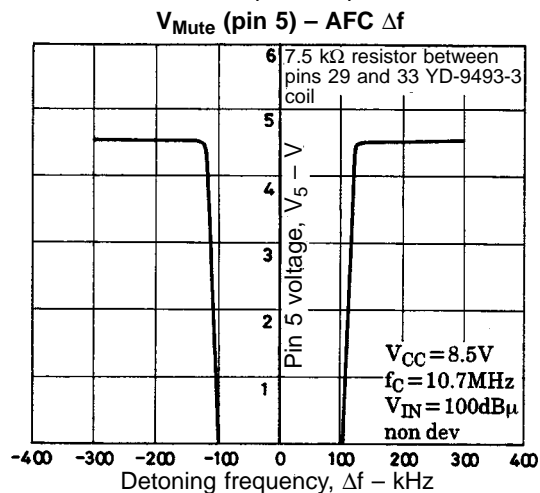
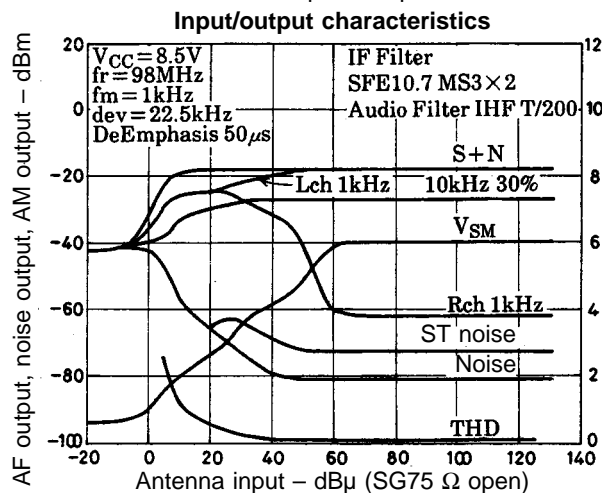
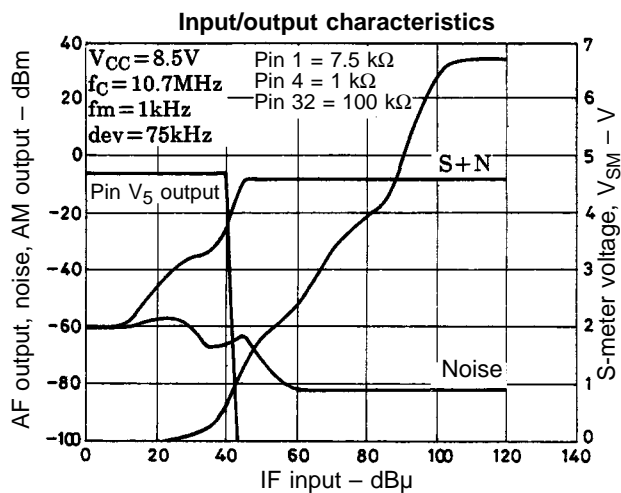
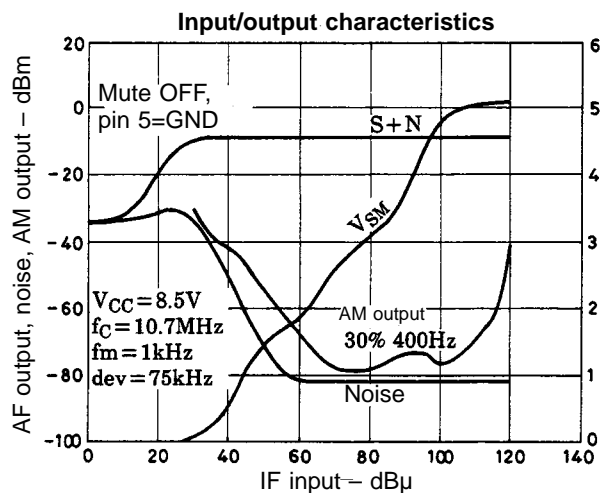

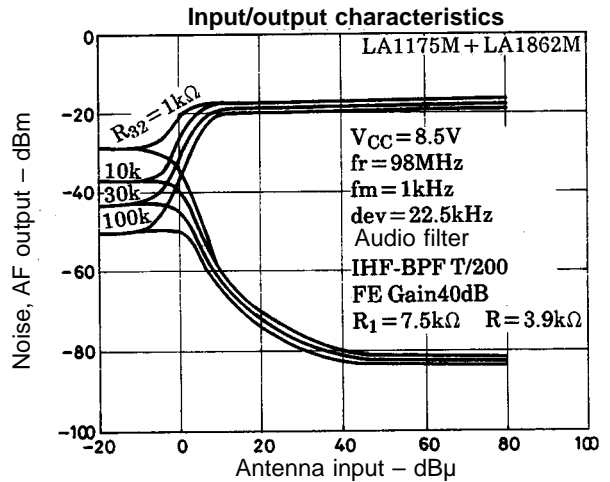
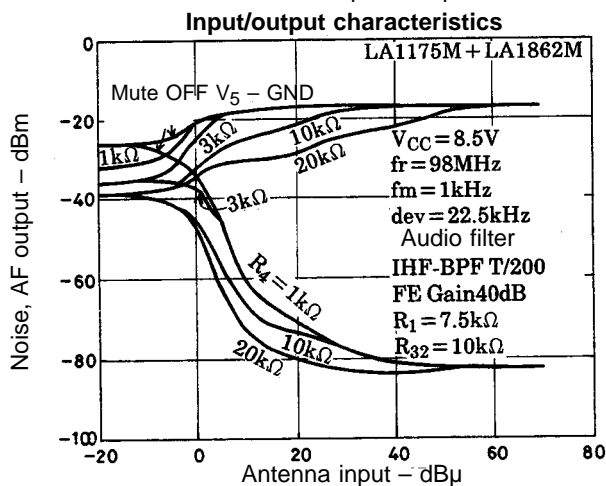
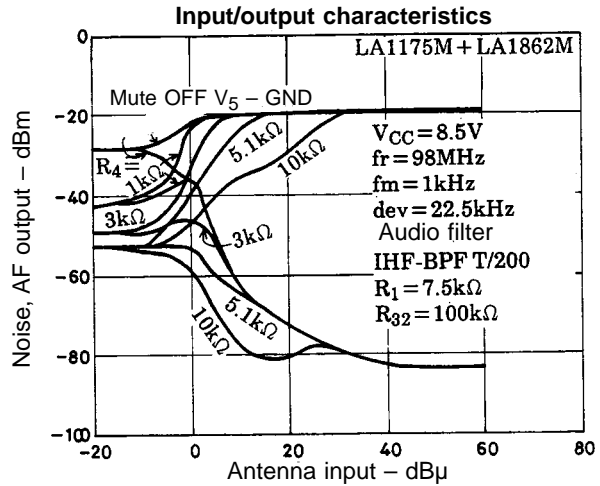
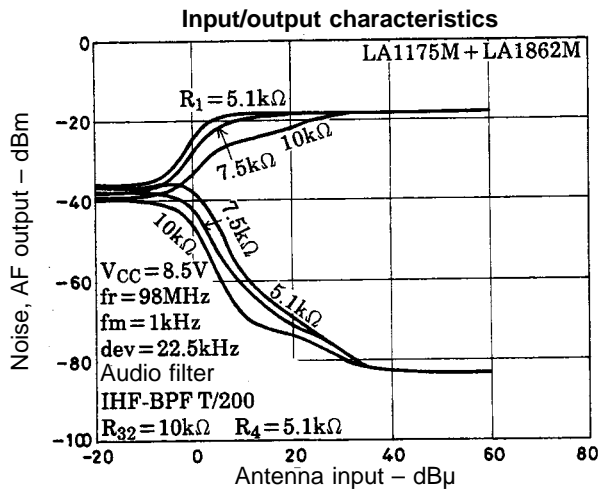
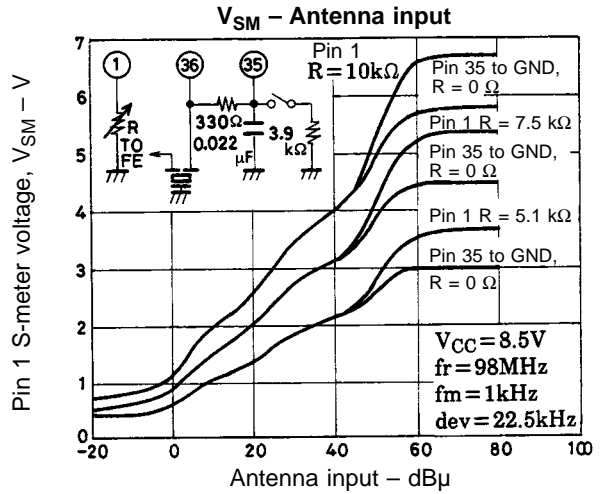
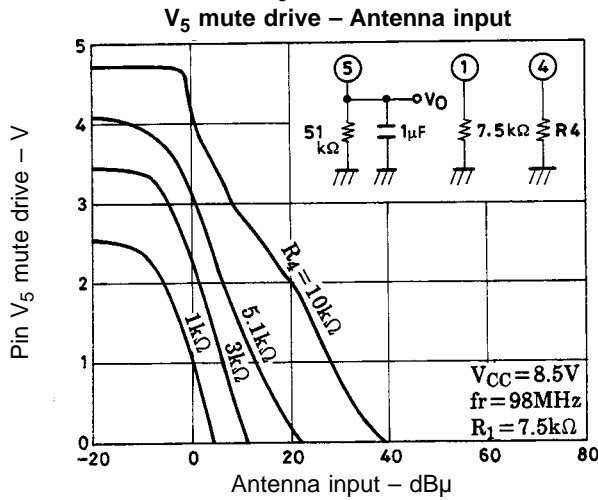
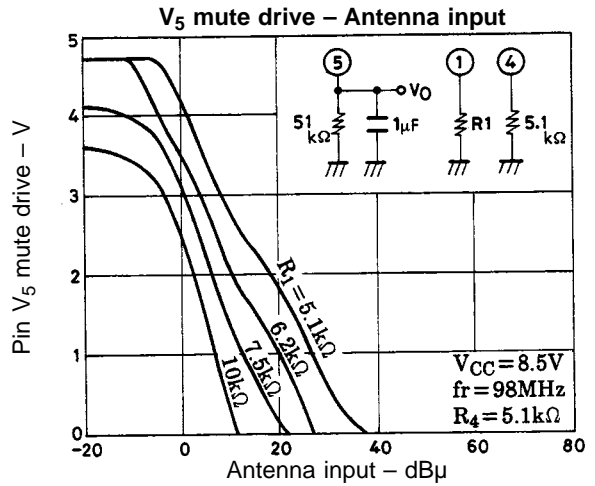
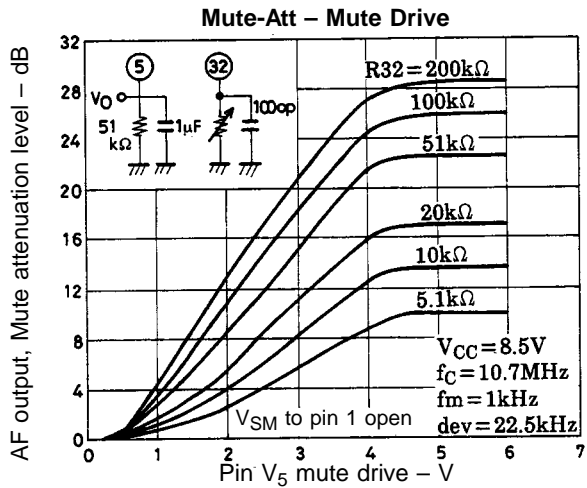

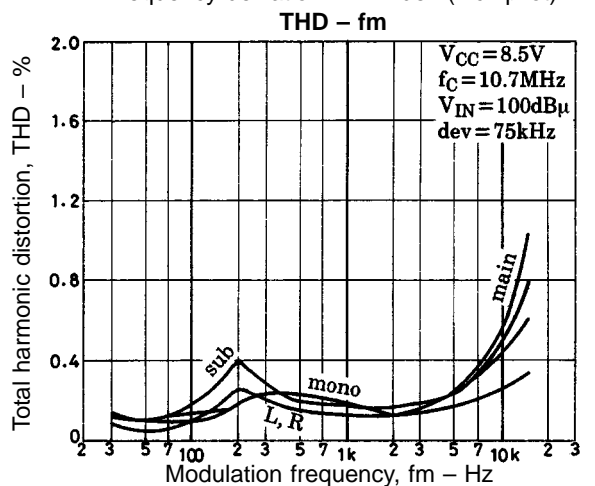
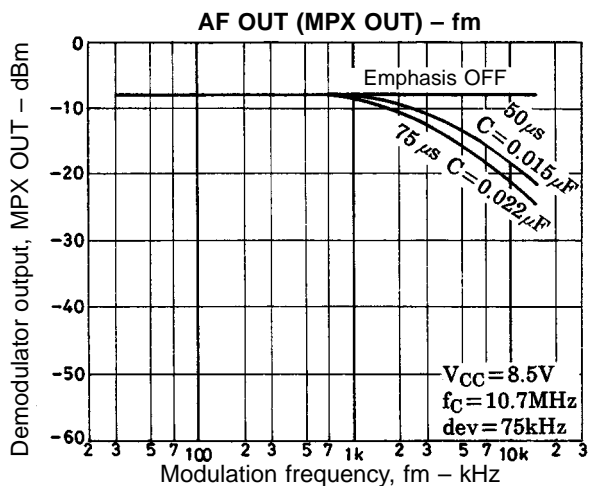
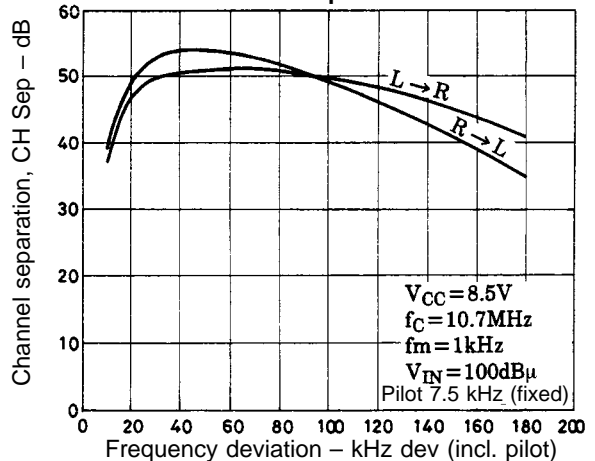
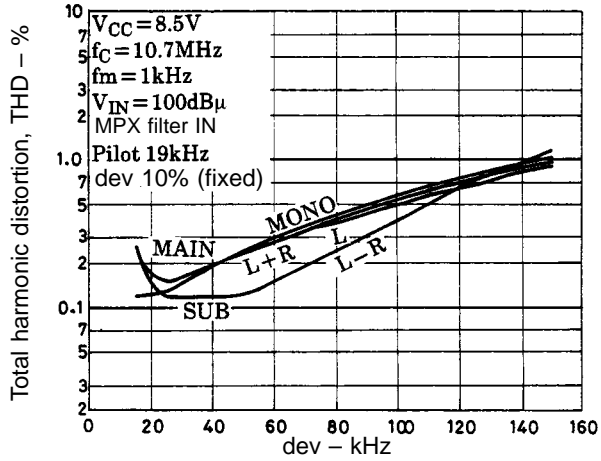
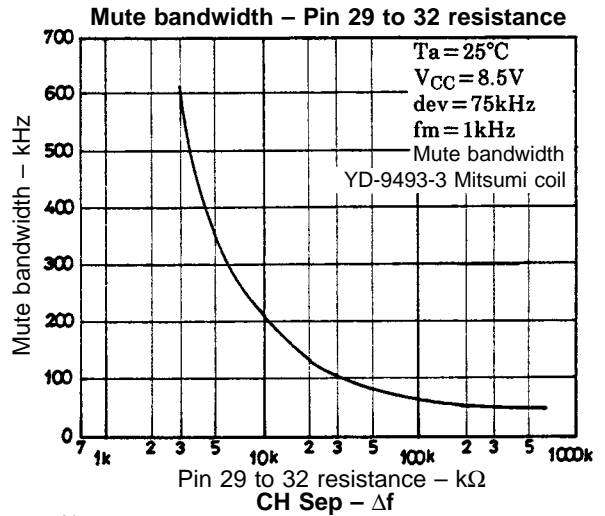
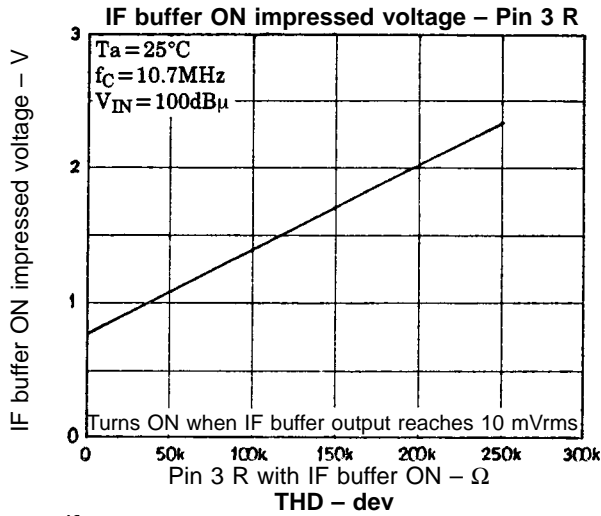
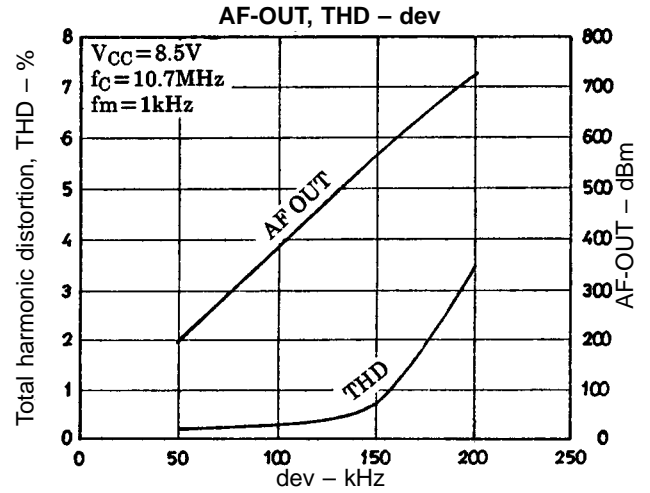
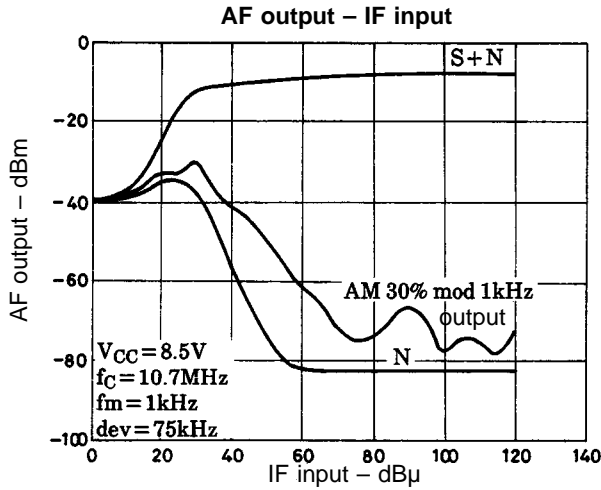

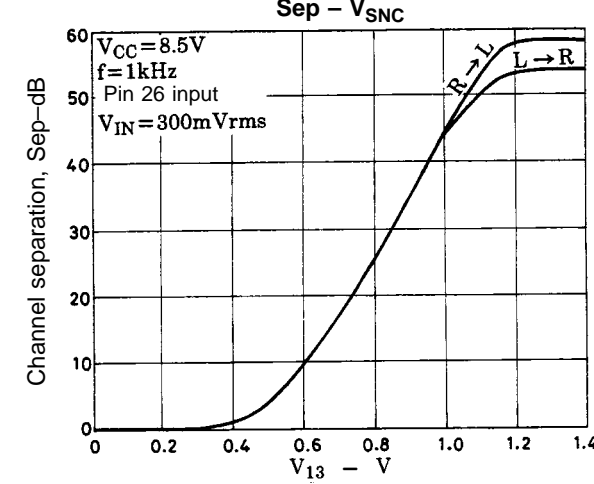
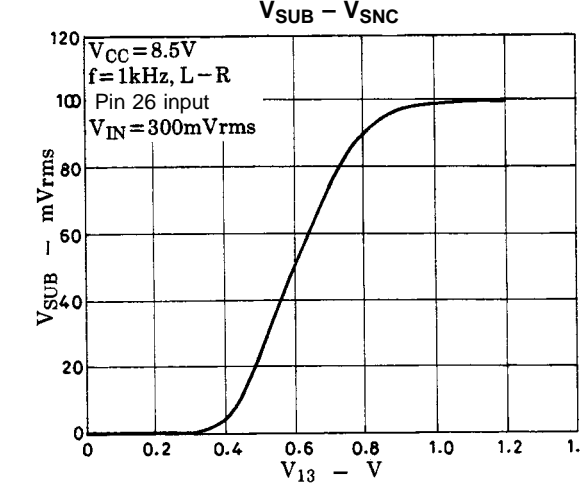
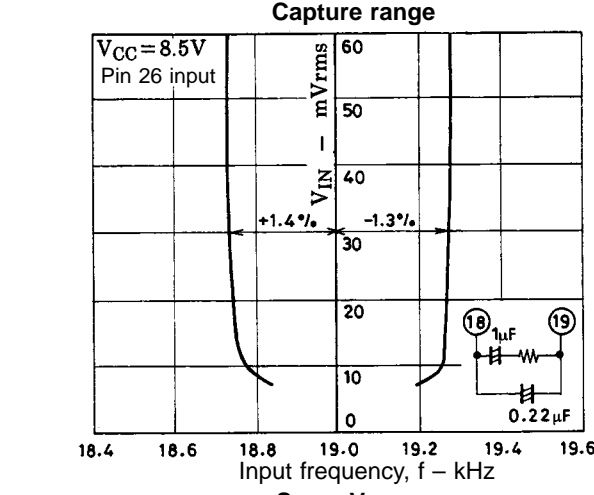
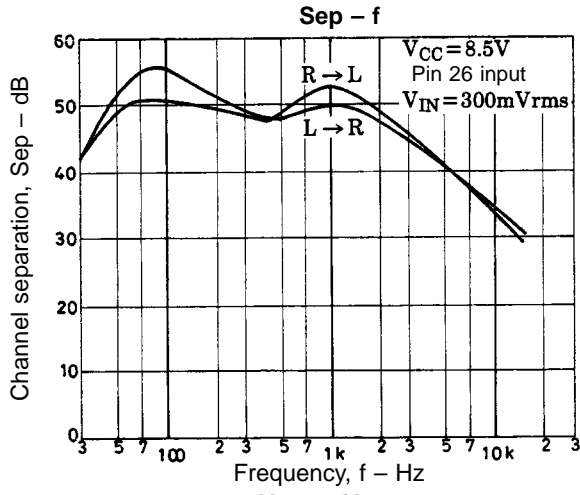
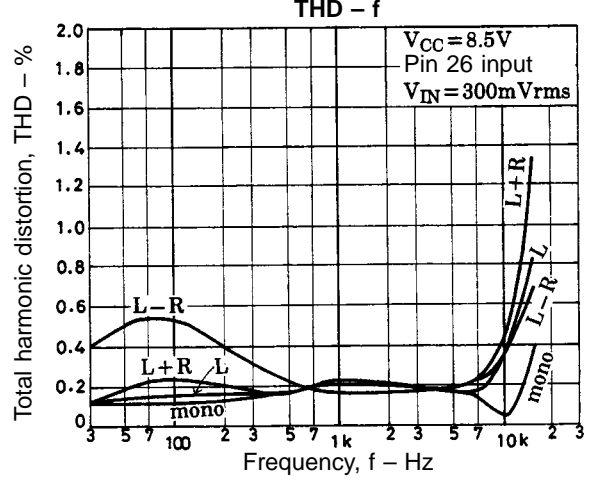
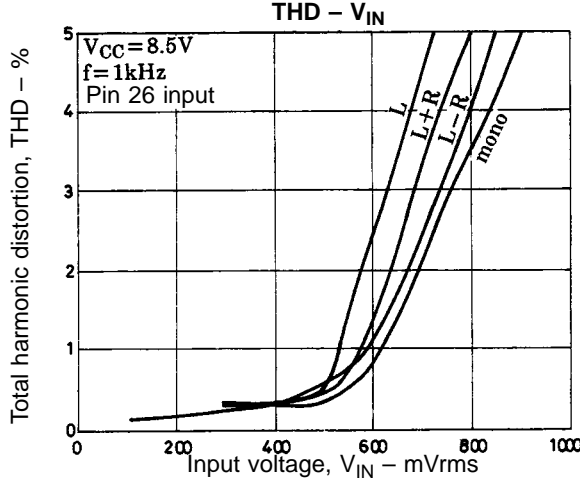
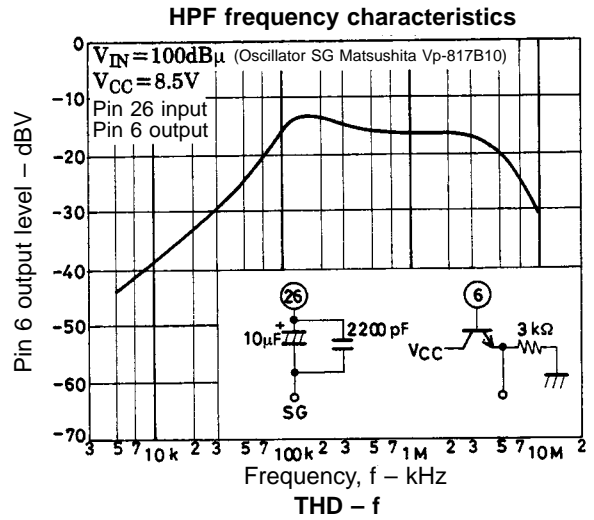
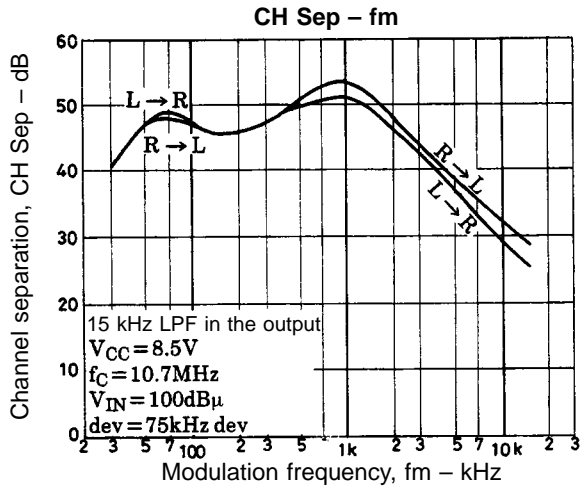

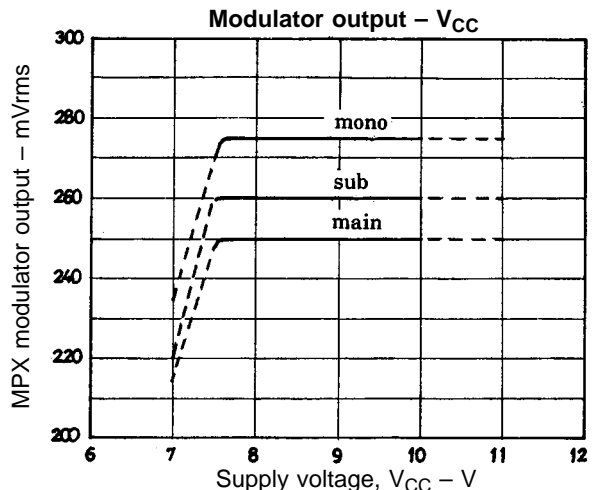
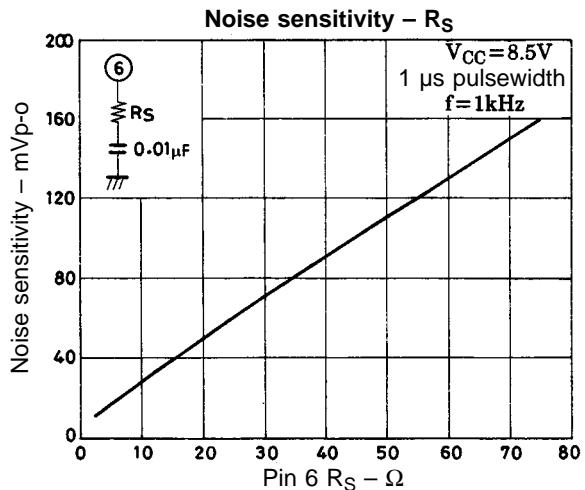
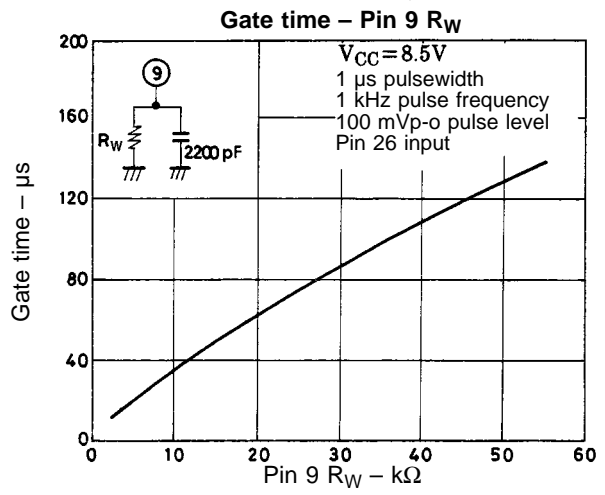
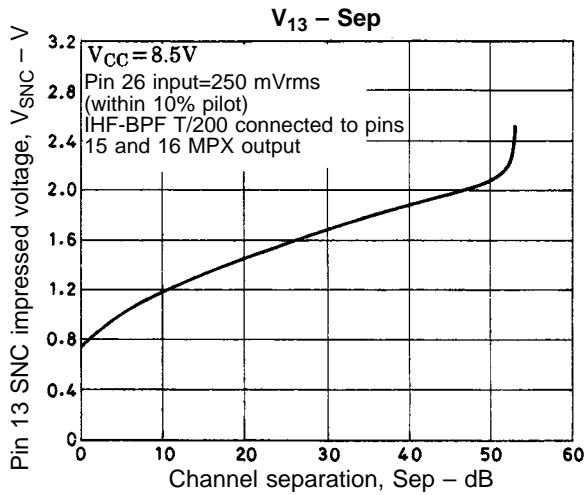
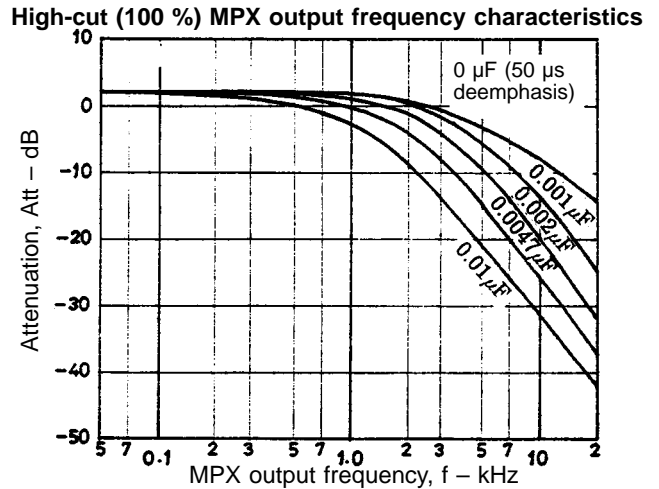
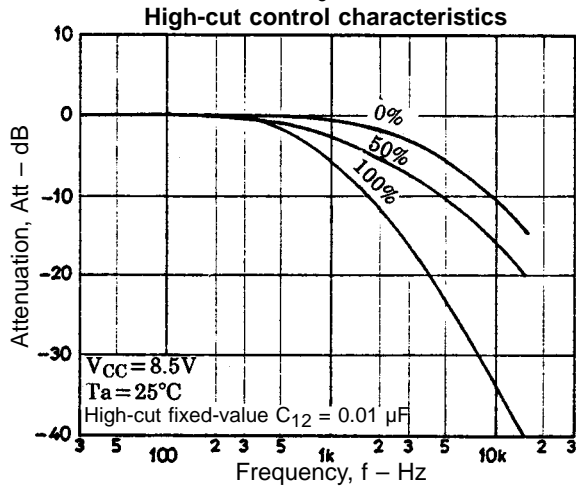
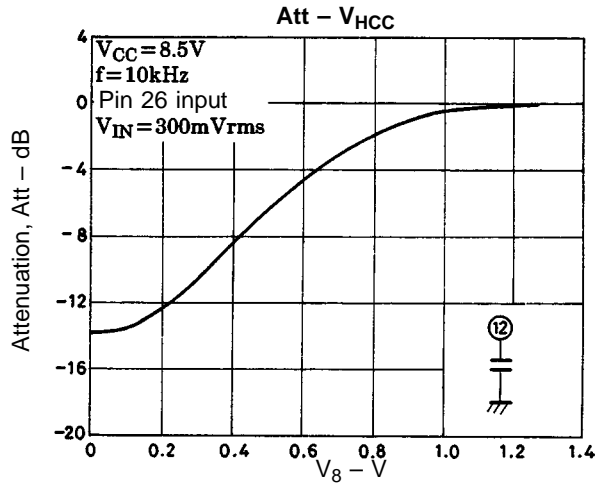
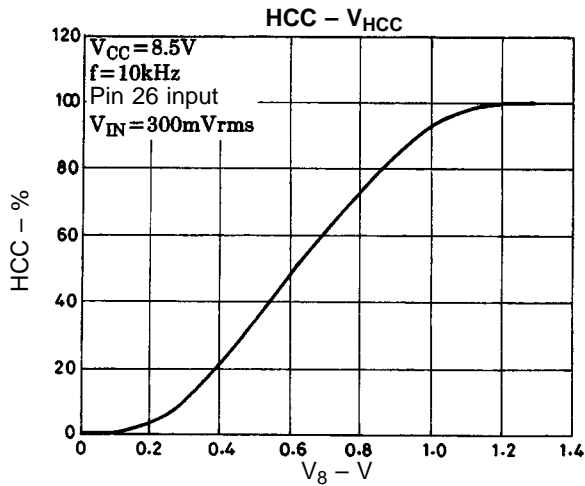

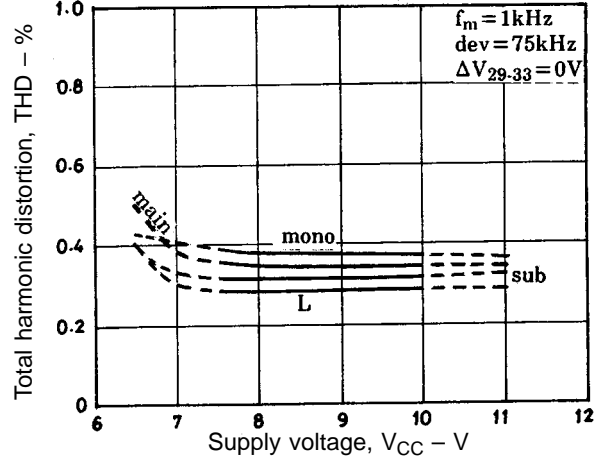
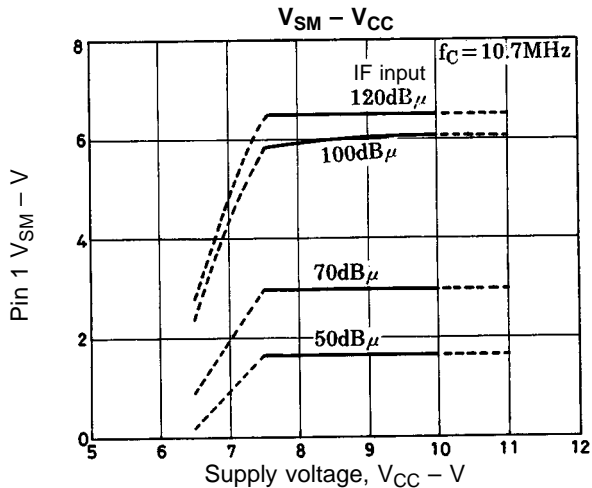
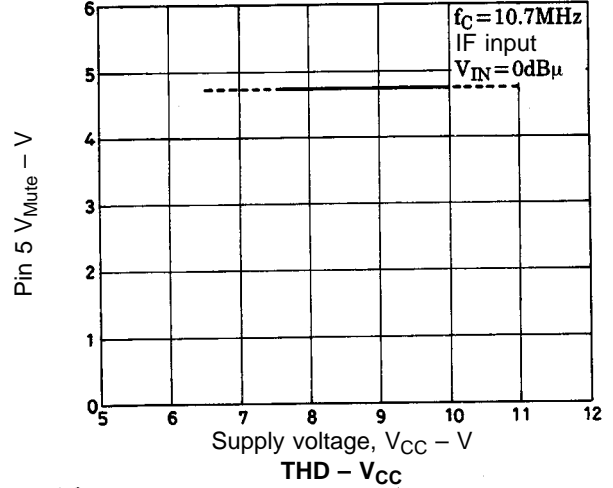
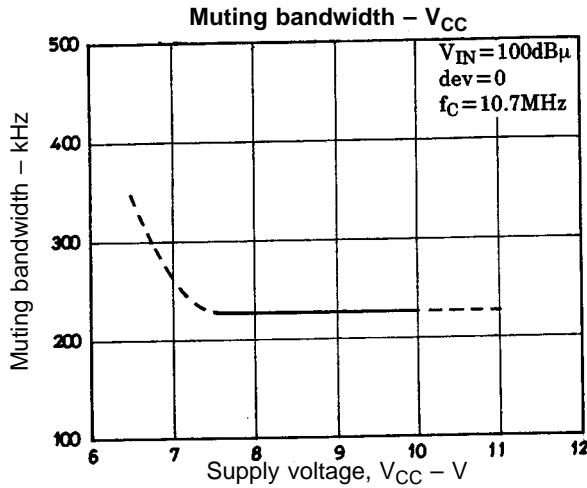
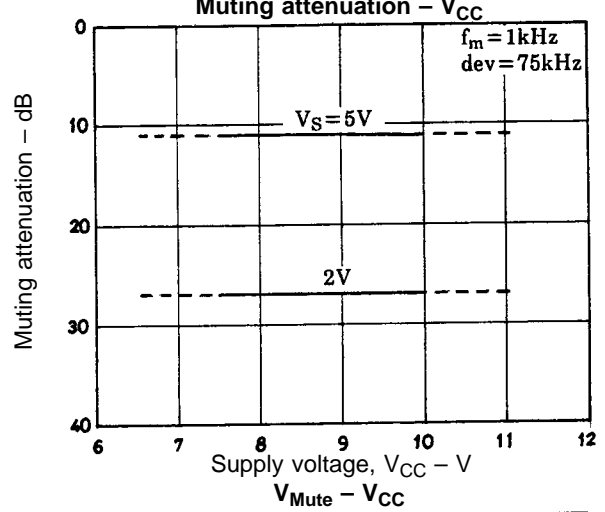
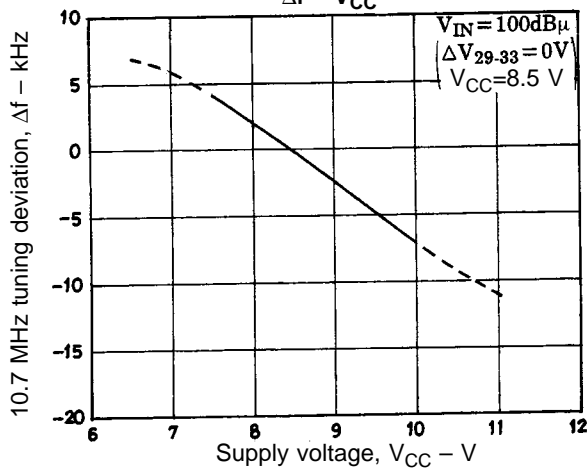
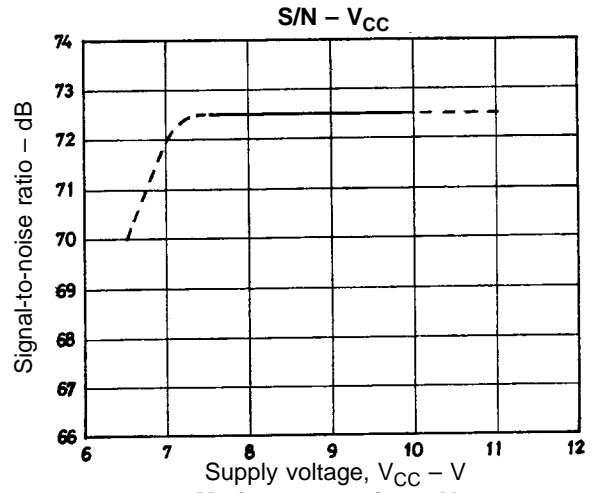
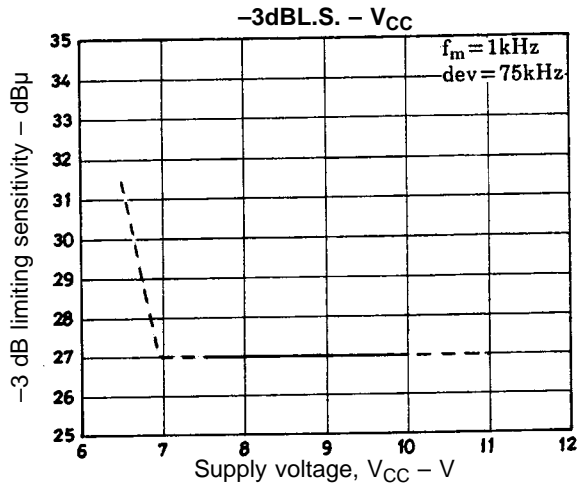

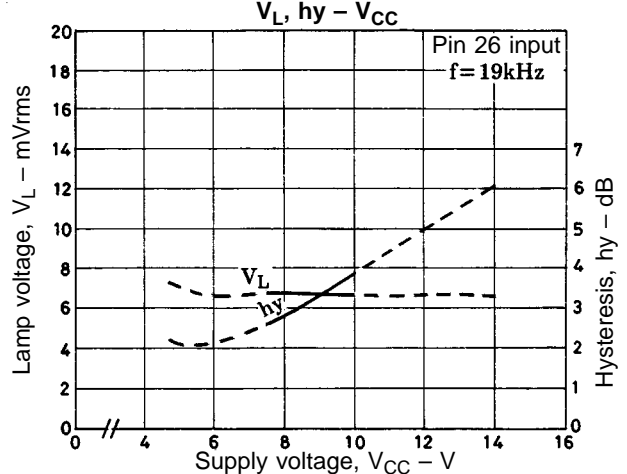
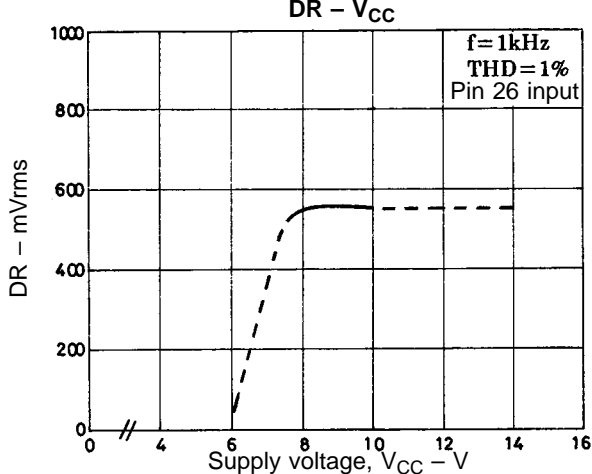
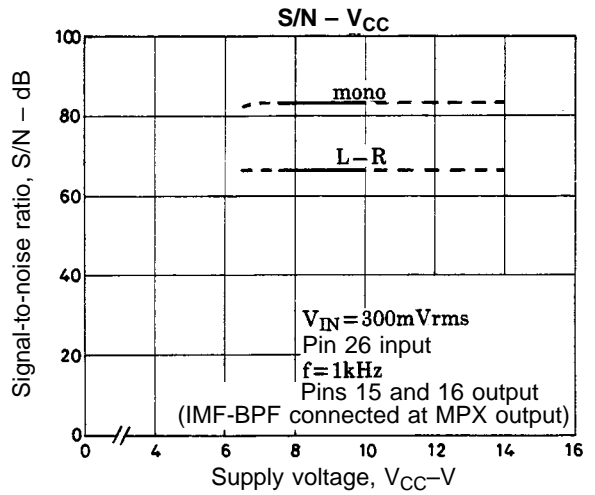
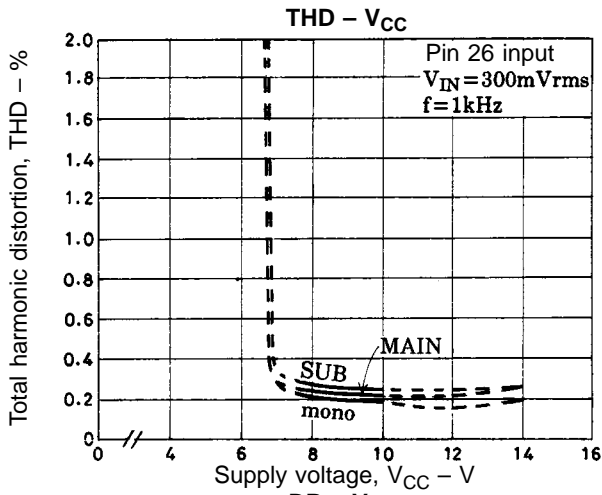
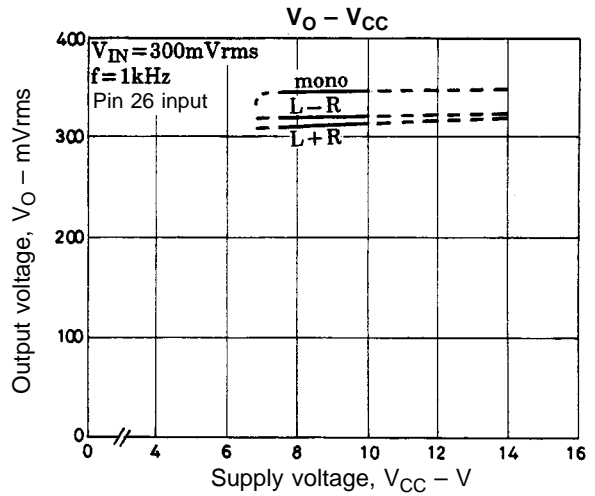
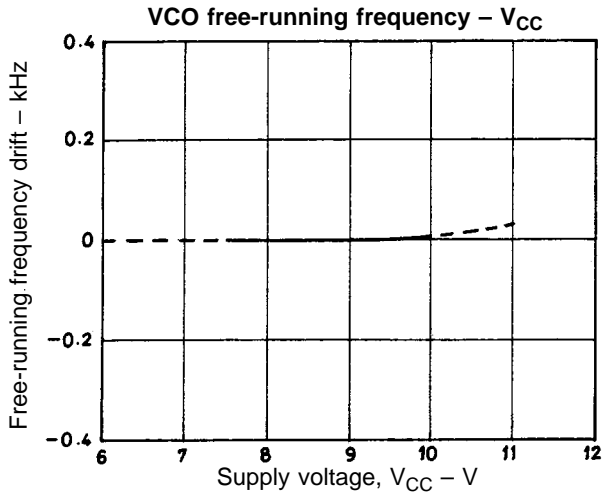
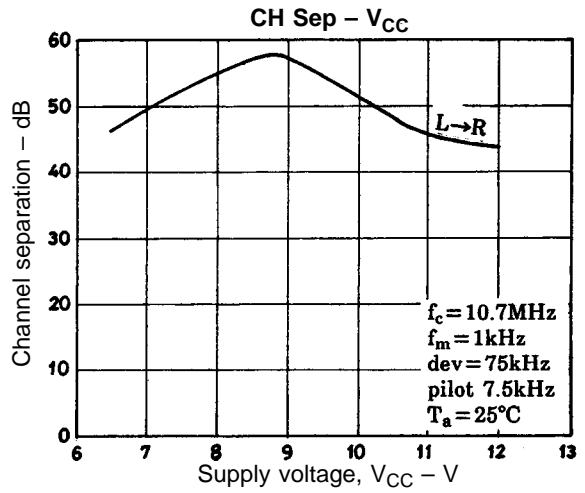
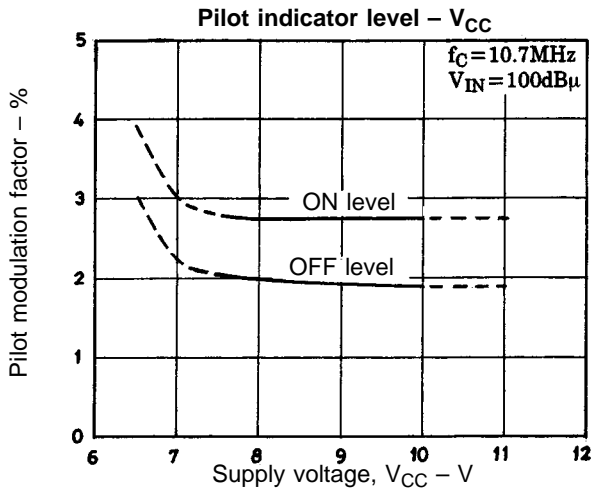

# LA1862M

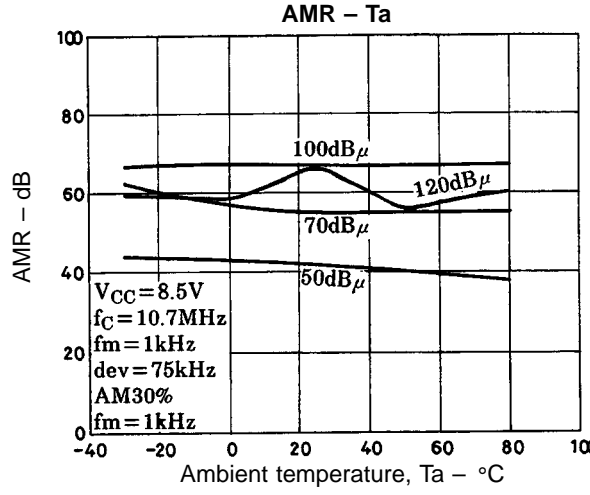
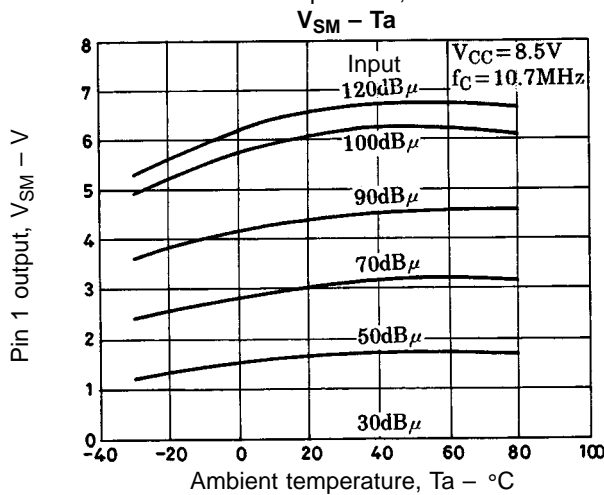
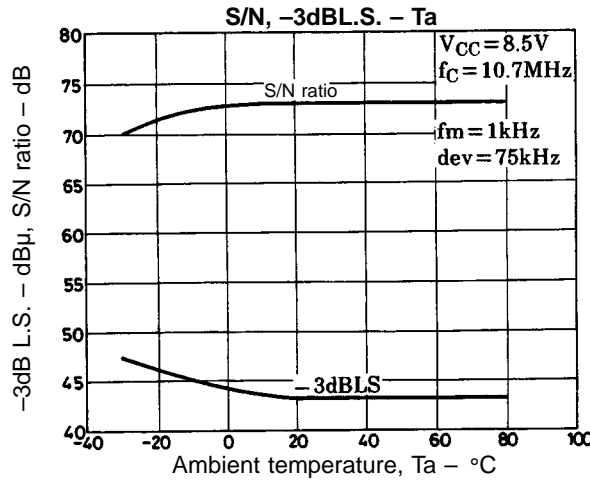
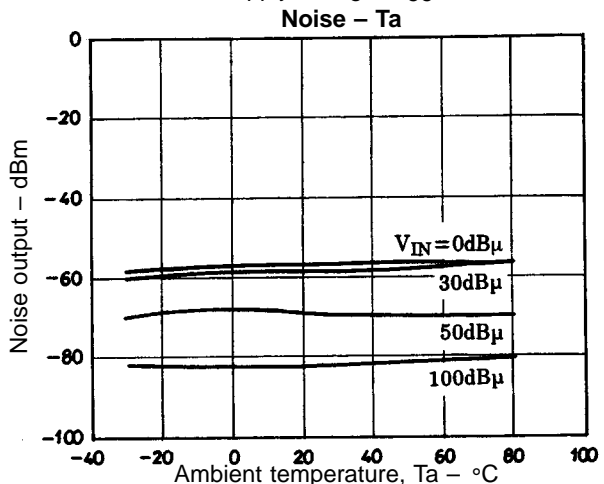
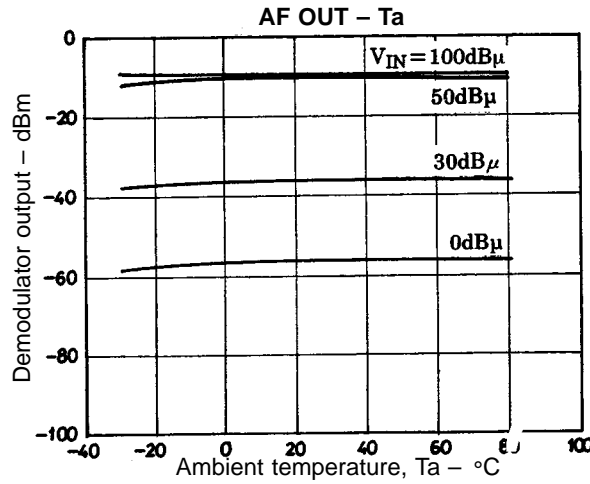
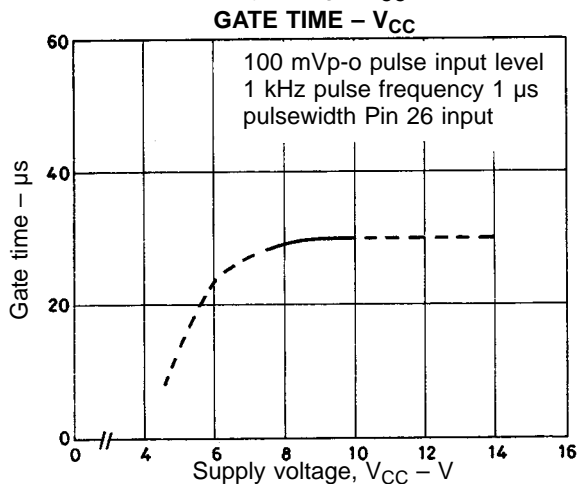
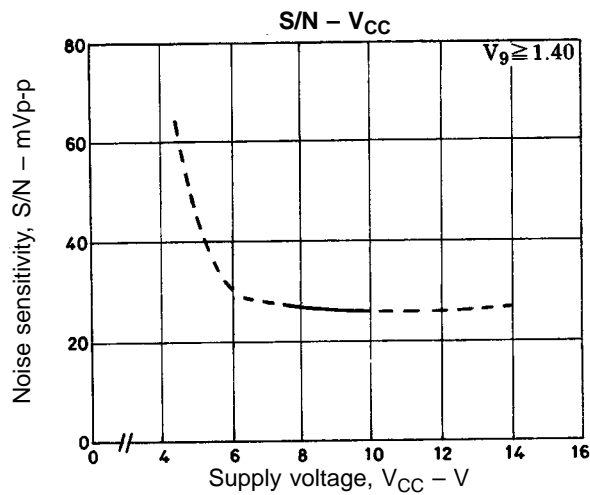
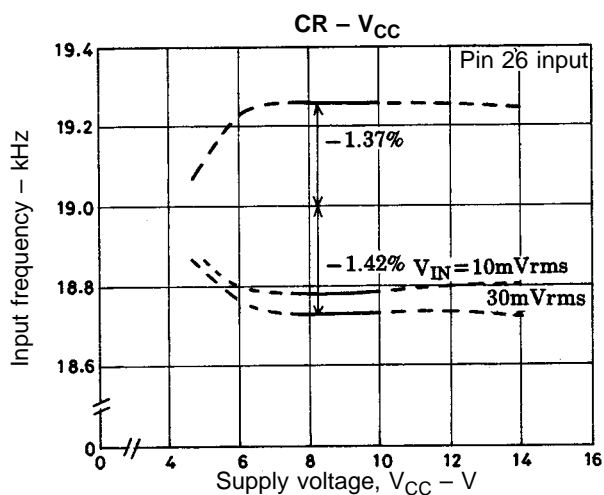



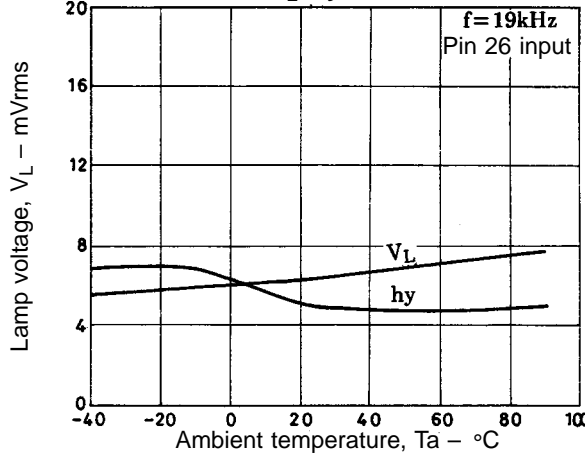
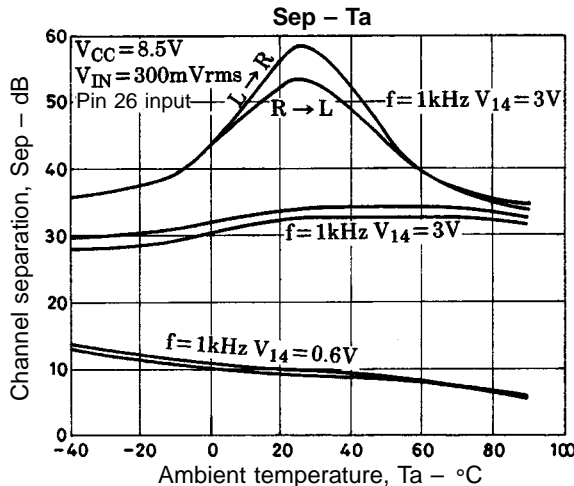
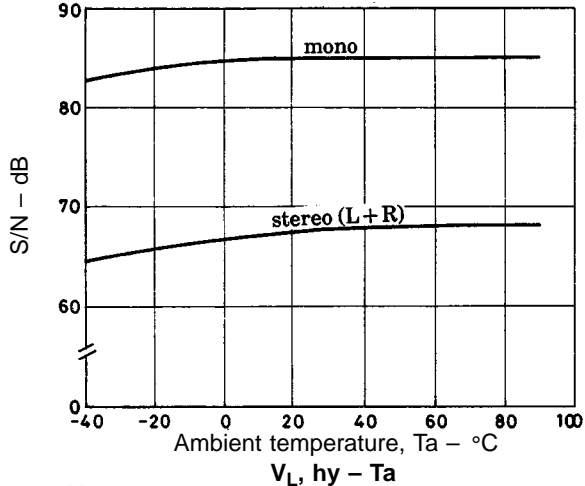
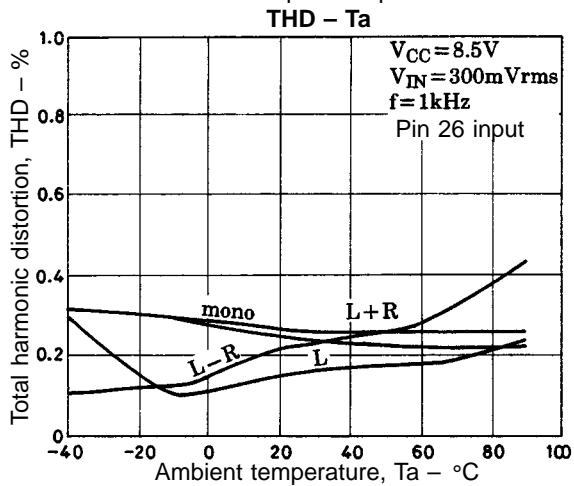
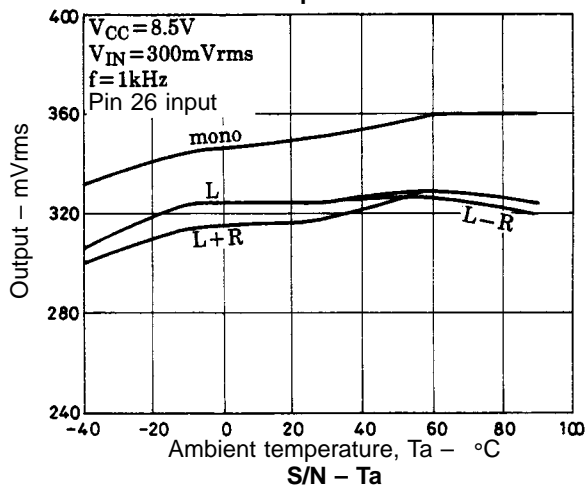
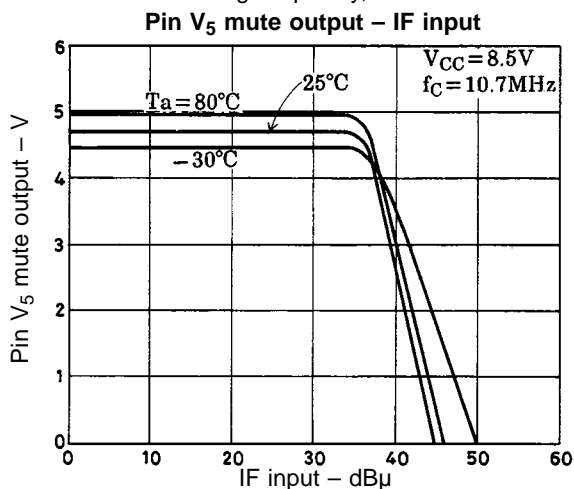
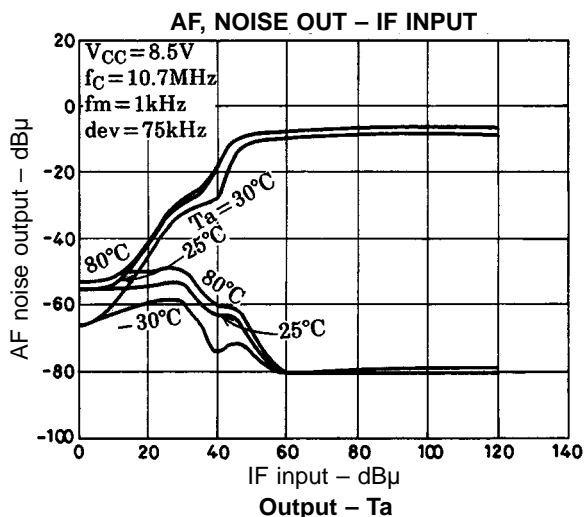
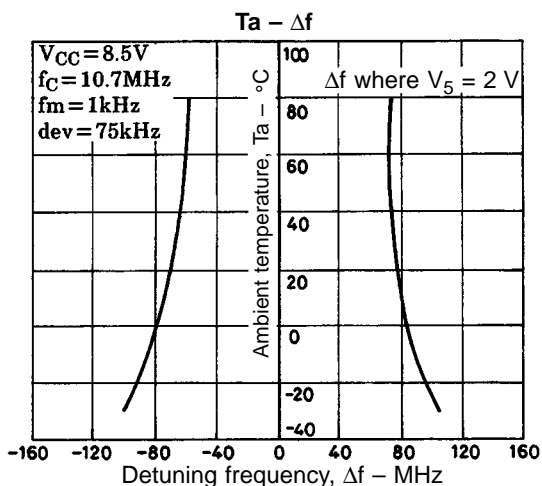

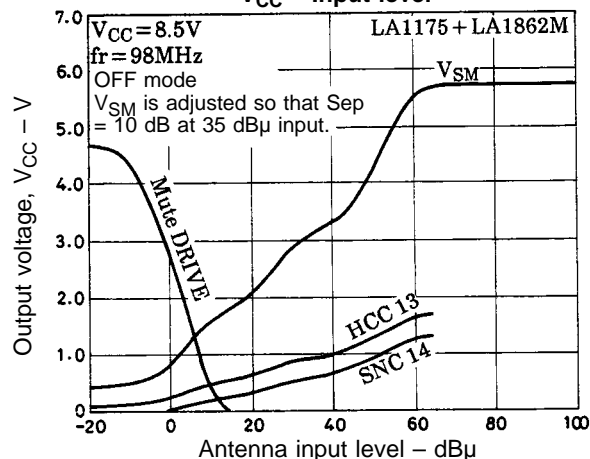
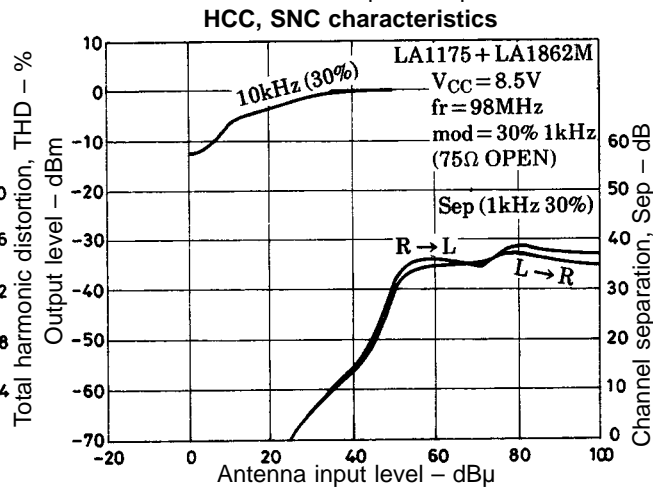
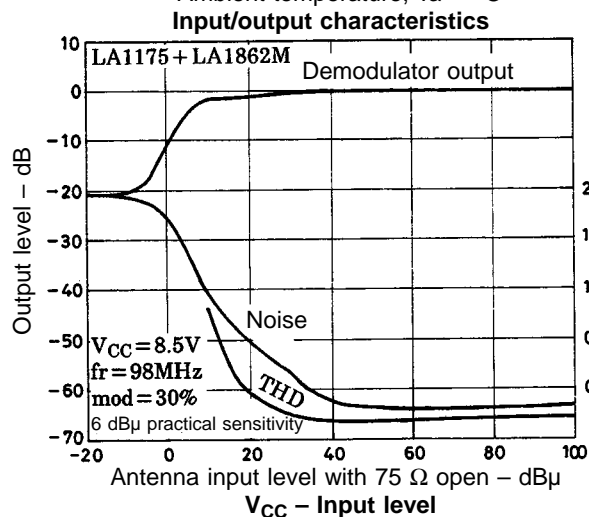
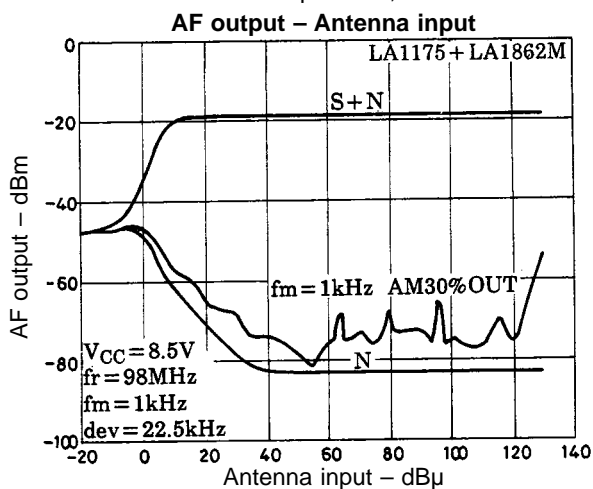
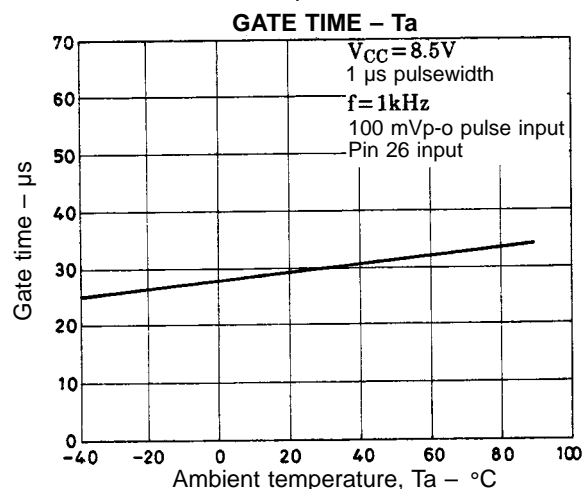
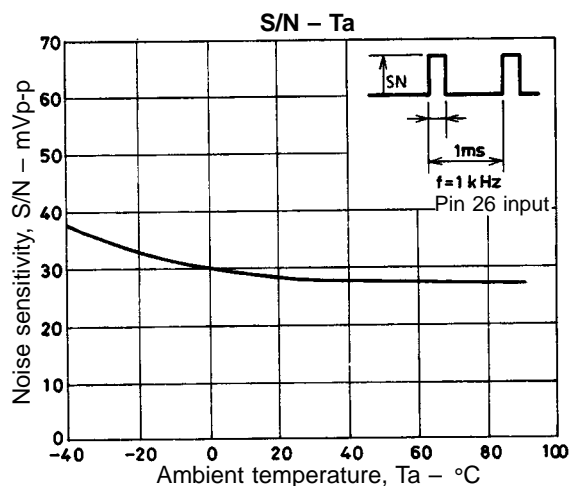
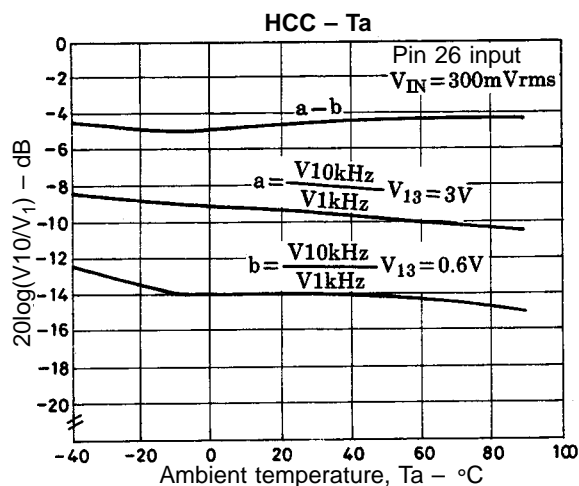

- No products described or contained herein are intended for use in surgical implants, life-support systems, aerospace equipment, nuclear power control systems, vehicles, disaster/crime-prevention equipment and the like, the failure of which may directly or indirectly cause injury, death or property loss.
- Anyone purchasing any products described or contained herein for an above-mentioned use shall:
  - ① Accept full responsibility and indemnify and defend SANYO ELECTRIC CO., LTD., its affiliates, subsidiaries and distributors and all their officers and employees, jointly and severally, against any and all claims and litigation and all damages, cost and expenses associated with such use:
  - ② Not impose any responsibility for any fault or negligence which may be cited in any such claim or litigation on SANYO ELECTRIC CO., LTD., its affiliates, subsidiaries and distributors or any of their officers and employees jointly or severally.
- Information (including circuit diagrams and circuit parameters) herein is for example only; it is not guaranteed for volume production. SANYO believes information herein is accurate and reliable, but no guarantees are made or implied regarding its use or any infringements of intellectual property rights or other rights of third parties.

This catalog provides information as of June, 1998. Specifications and information herein are subject to change without notice.