

ENHANCED, LOW-INPUT VOLTAGE-MODE SYNCHRONOUS BUCK CONTROLLER

FEATURES

- Operating Input Voltage 2.25 V to 5.5 V
- Output Voltage as Low as 0.7 V
- 1% Internal 0.7 V Reference
- Predictive Gate Drive™ N-Channel MOSFET Drivers for Higher Efficiency
- Externally Adjustable Soft-Start and Short Circuit Current Limit
- Programmable Fixed-Frequency 100 KHz-to-1 MHz Voltage-Mode Control
- Source-Only Current or Source/Sink Current
- Quick Response Output Transient Comparators with Power Good Indication Provide Output Status
- 16-Pin PowerPAD™ Package

APPLICATIONS

- Networking Equipment
- Telecom Equipment
- Base Stations
- Servers
- DSP Power

DESCRIPTION

The TPS4002x family of dc-to-dc controllers are designed for non-isolated synchronous buck regulators, providing enhanced operation and design flexibility through user programmability.

The TPS4002x utilizes a proprietary Predictive Gate Drive™ technology to minimize the diode conduction losses associated with the high-side and synchronous rectifier N-channel MOSFET transistors. The integrated charge pump with boost circuit provides a regulated 5-V gate drive for both the high side and synchronous rectifier N-channel MOSFETs. The use of the Predictive Gate Drive™ technology and charge pump/boost circuits combine to provide a highly efficient, smaller and less expensive converter.

Design flexibility is provided through user programmability of such functions as: operating frequency, short circuit current detection thresholds, soft-start ramp time, and external synchronization frequency. The operating frequency is programmable using a single resistor over a frequency range of 100 kHz to 1 MHz. Higher operating frequencies yield smaller component values for a given converter power level as well as faster loop closure.

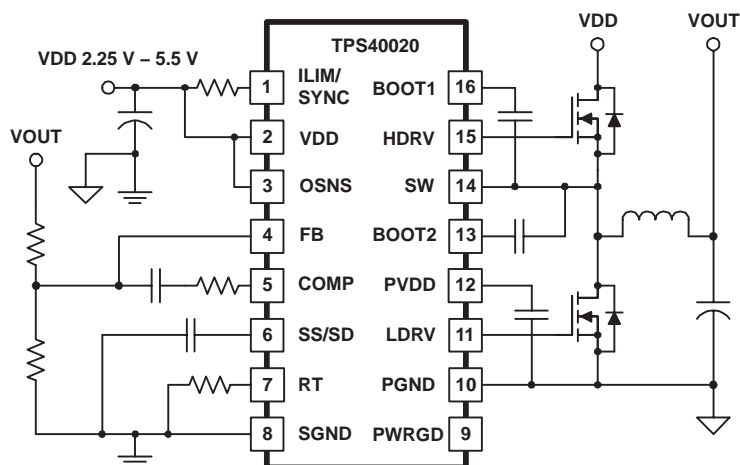

UDG-02094



Please be aware that an important notice concerning availability, standard warranty, and use in critical applications of Texas Instruments semiconductor products and disclaimers thereto appears at the end of this data sheet.

PowerPAD™ and Predictive Gate Drive™ are trademarks of Texas Instruments.

DESCRIPTION (CONTINUED)

The short circuit current detection is programmable through a single resistor, allowing the short circuit current limit detection threshold to be easily tailored to accommodate different size ($R_{DS(on)}$) MOSFETs. The short circuit current function provides pulse-by-pulse current limiting during soft-start and short term transient conditions as well as a fault counter to handle longer duration short circuit current conditions. If a fault is detected the controller shuts down for a period of time determined by six (6) consecutive soft-start cycles. The controller automatically retries the output every seventh (7th) soft-start cycle.

In addition to determining the off time during a fault condition, the soft-start ramp provides a closed loop controlled ramp of the converter output during startup. Programmability allows the ramp rate to be adjusted for a wide variety of output L-C component values.

The output voltage transient comparators provide a quick response, first strike, approach to output voltage transients. The output voltage is sensed through a resistor divider at the OSNS pin. If an overvoltage condition is detected the HDRV gate drive is shut-off and the LDRV gate drive is turned on until the output is returned to regulation. Similarly, if an output undervoltage condition is sensed the HDRV gate drive goes to 95% duty cycle to pump the output back up quickly. In either case, the PowerGood open drain output pulls low to indicate an output voltage out of regulation condition. The PowerGood output can be daisy-chained to the SS/SD pin or enable pin of other controllers or converters for output voltage sequencing. The transient comparators can be disabled by simply tying the OSNS pin to VDD.

The TPS4002x can be externally synchronized through the ILIM/SYNC pin up to $1.5\times$ the free-running frequency. This allows multiple controllers to be synchronized to eliminate EMI concerns due to input beat frequencies between controllers.

INTERNAL BLOCK DIAGRAM

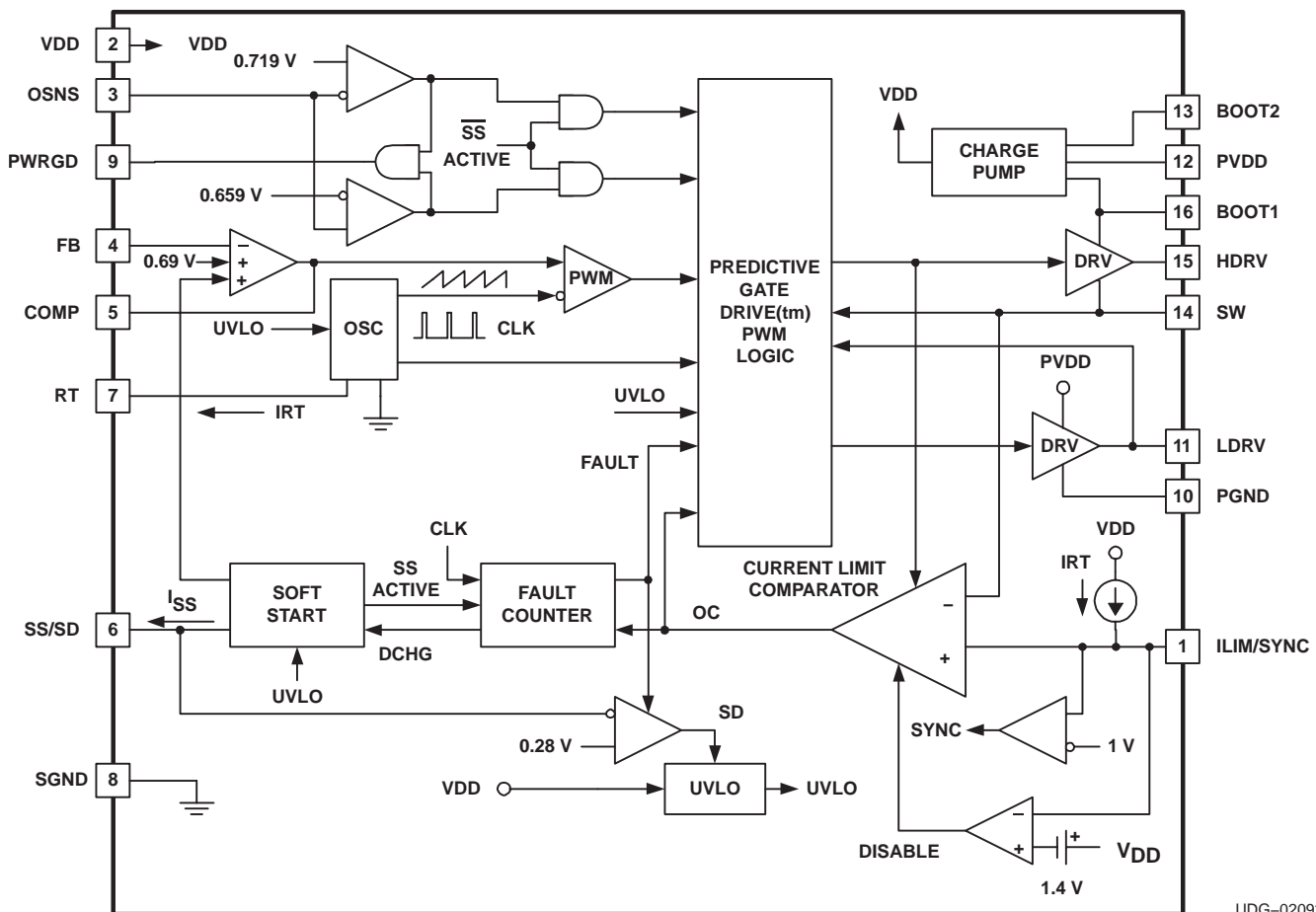

UDG-02092



These devices have limited built-in ESD protection. The leads should be shorted together or the device placed in conductive foam during storage or handling to prevent electrostatic damage to the MOS gates.

ORDERING INFORMATION

T _A	LOAD CURRENT ⁽¹⁾	PACKAGE	PART NUMBER
–40°C to 85°C	SOURCE	Plastic HTSSOP (PWP) ⁽²⁾	TPS40020PWP
	SOURCE/SINK	Plastic HTSSOP (PWP) ⁽²⁾	TPS40021PWP

(1) See page 7 for explanation.

(2) The PWP package is also available taped and reeled. Add an R suffix to the device type (i.e., TPS40020PWPR). See the application section of the data sheet for PowerPAD drawing and layout information.

ABSOLUTE MAXIMUM RATINGS

over operating free-air temperature range unless otherwise noted⁽⁴⁾

		TPS4002X	UNIT
Input voltage range, V _{IN}	SS/SD, VDD, PVDD, OSNS	–0.3 to 6	V
	BOOT2, BOOT1	V _{SW} + 6	
	SW	–3.0 to 10.5	
	SWT (SW transient < 50 ns)	–5	
	FB, ILIM	–0.3 to 6.0	
Output voltage range, V _{OUT}	COMP, PWRGD, RT	–0.3 to 6	
Sink current, I _S	PWRGD	10	mA
Operating virtual junction temperature range, T _J		–40 to 125	°C
Storage temperature, T _{stg}		–55 to 150	
Lead temperature 1,6 mm (1/16 inch) from case for 10 seconds		260	

(4) Stresses beyond those listed under “absolute maximum ratings” may cause permanent damage to the device. These are stress ratings only, and functional operation of the device at these or any other conditions beyond those indicated under “recommended operating conditions” is not implied. Exposure to absolute-maximum-rated conditions for extended periods may affect device reliability.

RECOMMENDED OPERATING CONDITIONS

	MIN	NOM	MAX	UNIT
Input voltage, V _{IN}	2.25		5.5	V
Operating junction temperature, T _J	–40		85	°C

PWP PACKAGE⁽⁵⁾⁽⁶⁾
(TOP VIEW)

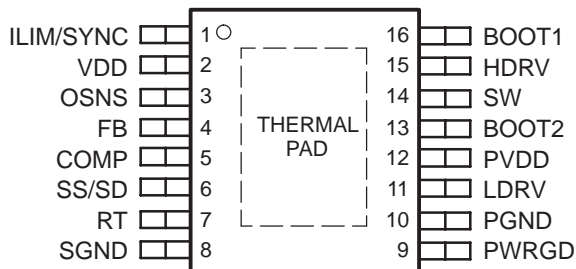

(5) For more information on the PWP package, refer to TI Technical Brief, Literature No. SLMA002.

(6) PowerPAD™ heat slug must be connected to SGND (Pin 8), or electrically isolated from all other pins.

ELECTRICAL CHARACTERISTICS

T_J = -40°C to 85°C, T_J = T_A, V_{DD} = 5.0 V (unless otherwise noted)

PARAMETER		TEST CONDITIONS	MIN	TYP	MAX	UNIT
INPUT SUPPLY						
V _{DD}	Input voltage range, VDD		2.25		5.50	V
V _{PVDD}	PVDD pin voltage	V _{DD} = 3.3 V		4.9	5.2	
I _{DD}	Switching current	500 kHz, No load on HDRV, LDRV		3.5	5.0	mA
	Quiescent current	FB = 0.8 V		2.0	3.0	
	Shutdown current	SS/SD = 0 V, Outputs OFF		0.38	1.00	
V _{UVLO}	Minimum on-voltage		1.95	2.05	2.15	V
	Hysteresis		80	130	200	mV
OSCILLATOR						
f _{OSC}	Accuracy	2.25 V ≤ V _{DD} ≤ 5.00 V, R _T = 69.8 kΩ	425	500	575	kHz
		2.25 V ≤ V _{DD} ≤ 5.00 V, R _T = 34.8 kΩ	800	950	1100	
V _{RAMP}	Ramp voltage	V _{PEAK} - V _{VAL}	0.80	0.93	1.07	V
V _{VAL}	Ramp valley voltage		0.24	0.31	0.41	
PWM						
d _{MAX}	Maximum duty cycle	V _{OSNS} = V _{DD} , R _T = 34.8 kΩ, V _{DD} = 3.3 V, FB = 0 V	85%	94%		
		V _{OSNS} = V _{DD} , R _T = 70 kΩ, V _{DD} = 5.0 V, FB = 0 V	90%	95%		
d _{MIN}	Minimum duty cycle				0%	
t _{MIN}	Minimum HDRV on-time ⁽²⁾			250		ns
ERROR AMPLIFIER						
V _{FB}	Feedback input voltage	-40°C ≤ T _A ≤ 85°C, 2.25V ≤ V _{DD} ≤ 5.00V	0.685	0.690	0.697	V
I _{BIAS}	Input bias current			30	130	nA
V _{OH}	High-level output voltage	I _{OH} = 0.5 mA, V _{FB} = GND	2.0	2.5		V
V _{OL}	Low-level output voltage	I _{OL} = 0.5 mA, V _{FB} = V _{DD}		0.08	0.15	
I _{OH}	High-level output source current	V _{FB} = GND	3	7		mA
I _{OL}	Low-level output sink current	V _{FB} = V _{DD}	3	8		
GBW	Gain bandwidth ⁽¹⁾		5	10		MHz
AOL	Open loop gain ⁽¹⁾		55	85		dB
CURRENT LIMIT						
I _{SINK}	Current limit sink current	2.25 V ≤ V _{DD} ≤ 5.00 V, R _T = 69.8 kΩ	165	190	215	μA
V _{OS}	Current limit offset voltage		-20	0	20	mV
t _{ON}	Minimum HDRV on-time in overcurrent	V _{DD} = 3.3 V		200	300	ns
t _{ON}	Switch leading-edge blanking pulse time ⁽¹⁾			140		
t _{SS}	Soft-start cycles			6		cycles
V _{ILIM}	Current limit input voltage range		2		V _{DD}	V
SOFT START						
I _{SS}	Soft-start source current	Outputs = OFF	2.0	3.3	5.4	μA

(1) Ensured by design. Not production tested.

(2) Operation below the minimum on-time could result in overlap of the HDRV and LDRV outputs.

ELECTRICAL CHARACTERISTICS (continued)

$T_J = -40^{\circ}\text{C}$ to 85°C , $T_J = T_A$, $V_{DD} = 5.0\text{ V}$ (unless otherwise noted)

PARAMETER		TEST CONDITIONS	MIN	TYP	MAX	UNIT
SHUTDOWN						
V_{SD}	Shutdown threshold voltage		0.22	0.26	0.29	V
V_{EN}	Device enable threshold voltage		0.25	0.28	0.32	
OUTPUT DRIVER						
R_{HDHI}	High-side driver pull-up resistance	$V_{(BOOT1)} - V_{(SW)} = 3.3\text{ V}$, $I_{SOURCE} = 100\text{ mA}$	1.0	2.5	5.0	Ω
R_{HDLO}	High-side driver pull-down resistance	$V_{(BOOT1)} - V_{(SW)} = 3.3\text{ V}$, $I_{SINK} = 100\text{ mA}$	0.8	1.5	3.0	
R_{LDHI}	Low-side driver pull-up resistance	$PVDD = 3.3\text{ V}$, $I_{SOURCE} = 100\text{ mA}$	1.0	2.5	5.0	
R_{LDLO}	Low-side driver pull-down resistance	$PVDD = 3.3\text{ V}$, $I_{SINK} = 100\text{ mA}$	0.45	0.80	1.50	
t_{LRISE}	Low-side driver rise time	$C_{LOAD} = 1\text{ nF}$		15	35	ns
t_{LFALL}	Low-side driver fall time			10	25	
t_{HRISE}	High-side driver rise time			15	35	
t_{HFALL}	High-side driver fall time			10	25	
THERMAL SHUTDOWN						
T_{SD}	Shutdown temperature ⁽¹⁾			165		$^{\circ}\text{C}$
	Hysteresis ⁽¹⁾			15		
CHARGE PUMP						
R_{VB2}	$R_{DS(on)}$ VDD to BOOT2	$V_{DD} = 5.0\text{ V}$, $I_{SOURCE} = 10\text{ mA}$	2.8	6.6	10.4	Ω
R_{B2P}	$R_{DS(on)}$ BOOT2 to PVDD	$V_{DD} = 5.0\text{ V}$, $I_{SOURCE} = 10\text{ mA}$	2.8	5.6	8.4	
R_{PB1}	$R_{DS(on)}$ PVDD to BOOT1	$V_{DD} = 5.0\text{ V}$, $I_{SOURCE} = 10\text{ mA}$	2.9	5.9	8.9	
POWER GOOD						
V_{PGD}	Pull-down voltage	$V_{OSNS} = 0.8\text{ V}$, $I_{PWRGD} = 0.5\text{ mA}$, $V_{DD} = 3.3\text{ V}$	50	90	140	mV
t_{ONHPL}	Output sense high to power good low delay time	$0.7\text{ V} \leq V_{OSNS} \leq 0.8\text{ V}$, $I_{PWRGD} = 0.5\text{ mA}$, $V_{DD} = 3.3\text{ V}$	6	10	14	μs
t_{ONLPL}	Output sense low to power good low delay time	$0.6\text{ V} \leq V_{OSNS} \leq 0.7\text{ V}$, $I_{PWRGD} = 0.5\text{ mA}$, $V_{DD} = 3.3\text{ V}$	6	10	14	
t_{SDHPH}	Shutdown high to power good high delay time	$V_{OSNS} = 0.7\text{ V}$, $I_{PWRGD} = 0.5\text{ mA}$, $V_{DD} = 3.3\text{ V}$, $0.0\text{ V} \leq V_{SS/SD} \leq 0.4\text{ V}$	2	4	6	
t_{SDLPL}	Shutdown low to power good low delay time	$V_{OSNS} = 0.7\text{ V}$, $I_{PWRGD} = 0.5\text{ mA}$, $V_{DD} = 3.3\text{ V}$, $0.0\text{ V} \leq V_{SS/SD} \leq 0.4\text{ V}$	0.5	1.5	3.0	
t_{ONHPH}	Output sense high to nominal to power good high delay time	$0.7\text{ V} \leq V_{OSNS} \leq 0.8\text{ V}$, $I_{PWRGD} = 0.5\text{ mA}$, $V_{DD} = 3.3\text{ V}$	140	500	1000	ns
t_{ONLPH}	Output sense low to nominal to power good high delay time	$0.6\text{ V} \leq V_{OSNS} \leq 0.7\text{ V}$, $I_{PWRGD} = 0.5\text{ mA}$, $V_{DD} = 3.3\text{ V}$	140	500	1000	
TRANSIENT COMPARATORS						
V_{OV}	Overvoltage output threshold voltage	Referenced to V_{FB}	23	29	35	mV
	Hysteresis		8	15	22	
V_{UV}	Undervoltage output threshold voltage		-37	-31	-25	
	Hysteresis		8	15	22	
V_{DIS}	OSNS minimum disable voltage	Referenced to V_{DD}	0.5			V

(1) Ensured by design. Not production tested.

ELECTRICAL CHARACTERISTICS (continued)

T_J = -40°C to 85°C, T_J = T_A, V_{DD} = 5.0 V (unless otherwise noted)

PARAMETER		TEST CONDITIONS	MIN	TYP	MAX	UNIT	
SYNCHRONIZATION							
V _{ENSY}	Synchronization enable low threshold voltage				0.7	V	
V _{BLNK}	Synchronization current limit enable threshold voltage	Referenced to VDD	-0.7				
t _{MIN}	Minimum synchronization input pulse width			35	50	ns	
PREDICTIVE DELAY							
V _{SWP}	Sense voltage to modulate delay			-200		mV	
t _{LDHD}	Maximum delay modulation	LDRV OFF-to-HDRV ON	40	65	90	ns	
	Counter delay/bit time	LDRV OFF-to-HDRV ON	2.5	4.5	6.2		
t _{HDLD}	Maximum delay modulation	HDRV OFF-to-LDRV ON	55	80	105		
	Counter delay/bit time	HDRV OFF-to-LDRV ON	2.2	5.0	6.5		
RECTIFIER ZERO CURRENT COMPARATOR							
V _{SW}	Sense voltage to turn off rectifier MOSFET	TPS40020	LDRV output = OFF	-5	-2.5	2	mV
t _{ZBLNK}	Zero current blanking time ⁽¹⁾			150		ns	

(1) Ensured by design. Not production tested.

TERMINAL FUNCTIONS

TERMINAL NAME	NO.	I/O	DESCRIPTION
BOOT1	16	I	This pin provides a bootstrapped supply for the high side FET driver, enabling the gate of the high side FET to be driven above the input supply rail. Connect a capacitor from this pin to the SW pin.
BOOT2	13	I	This pin provides a secondary bootstrapping necessary for generation of PVDD. Connect a capacitor from this pin to SW.
COMP	5	O	Output of the error amplifier. Refer to <i>Electrical Characteristics</i> table for loading constraints.
FB	4	I	Inverting input of the error amplifier. In normal operation, V _{FB} is equal to the internal reference level of 690 mV.
HDRV	15	O	The gate drive output for the high side N-channel MOSFET switch is bootstrapped to near PVDD for good enhancement of the high-side switch. The HDRV switches from BOOT1 to SW.
ILIM/SYNC	1	I	The current limit pin is used to set the current limit threshold. A current sink from this pin to GND sets the threshold voltage for output short circuit current across a resistor connected to VDD. Synchronization is accomplished by pulling I _{MAX} to less than 1 V for a period greater than the minimum pulse width and then releasing. An open collector or drain device should be used. These pulses must be of higher frequency than the free running frequency of the local oscillator.
LDRV	11	O	Gate drive output for the low-side synchronous rectifier N-channel MOSFET. LDRV switches from PVDD to PGND.
OSNS	3	O	The output sense pin is connected to a resistor divider from V _{OUT} to GND (identical to the main feedback loop) and is used to sense power good condition and provides reference for the transient comparators.
PGND	10	O	Power (high-current) ground used by LDRV.
PWRGD	9	-	Power good. This is an open-drain output which connects to the supply via an external resistor.
PVDD	12	O	This pin is the regulated output of the charge-pump and provides the supply voltage for the LDRV driver stage. PVDD also drives the bootstrap circuit which generates the voltage on BOOT1.
RT	7	I	External pin for programming the oscillator frequency. Connected a resistor between this pin and GND.
SGND	8	-	Signal ground
SS/SD	6	I	The soft-start/shutdown pin provides user programmable soft-start timing and shutdown capability for the controller.
SW	14	I	This pin, used for overcurrent, zero-current, and in the anti-cross conduction sensing is connected to the switched node on the converter. Output short circuit is detected by sensing the voltage at this pin with respect to VDD while the high-side switch is on. Zero current is detected by sensing the pin voltage with respect to ground when the low-side rectifier MOSFET is on.
VDD	2	I	Power input for the device. Maximum voltage is 5.5 V. De-coupling of this pin is required.

APPLICATION INFORMATION

The TPS4002x series of devices are low-input voltage, synchronous, voltage mode-buck controllers. A typical application circuit is shown in Figure 1. These controllers are designed to allow construction of high-performance dc-to-dc converters with input voltages from 2.25 V to 5.5 V, and output voltages as low as 690 mV. Using a top side N-channel MOSFET for the primary buck switch results in lower switch resistance for a given gate charge.

The device controls the delays from main switch off to rectifier turn on and from rectifier turn off to main switch turn on in a way that minimizes diode losses (both conduction and recovery) in the synchronous rectifier. The reduction in these losses is significant and can mean that for a given converter power level, smaller FETs can be used, or that heat sinking can be reduced or even eliminated.

The TPS40021 is the controller of choice for most general purpose synchronous buck designs, operating in two quadrant mode (i.e. source or sink current) full time. This choice provides the best performance for output voltage load transient response over the widest load current range.

The TPS40020 operates in single quadrant mode (source current only) full time, allowing the paralleling of converters. Single quadrant operation ensures one converter does not pull current from a paralleled converter. A converter using one of these controllers emulates a non-synchronous buck converter at light loads. When current in the output inductor attempts to reverse, an internal zero-current detection circuit turns OFF the synchronous rectifier and causes the current flow in the inductor to become discontinuous. At average load currents greater than the peak amplitude of the inductor ripple current, the converter returns to operation as a synchronous buck converter to maximize efficiency.

The controller provides for a coarse short circuit current-limit function that provides pulse-by-pulse current limiting, as well as integrates short circuit current pulses to determine the existence of a persistent fault state at the converter output. If a fault is detected, the converter shuts down for a period of time (determined by six soft-start cycles) and then restarts. The current-limit threshold is adjustable with a single resistor connected from VDD to the ILIM/SYNC pin. This overcurrent function is designed to protect against catastrophic faults only, and cannot be guaranteed to protect against all overcurrent conditions.

The controller implements a closed-loop soft start function. Startup ramp time is set by a single external capacitor connected to the SS/SD pin. The SS/SD pin also doubles as a shutdown function.

VOLTAGE REFERENCE

The bandgap cell is designed with a trimmed, curvature corrected (< 1%) 0.69-V output, allowing output voltages as low as 690 mV to be obtained.

Oscillator

The ramp waveform is a saw-tooth form at the PWM frequency with a peak voltage of 1.25 V, and a valley of 0.3 V. The PWM duty cycle is limited to a maximum of 97%, allowing the bootstrap and charge pump capacitors to charge during every cycle.

APPLICATION INFORMATION

Bootstrap/Charge Pump

The TPS4002X series includes a charge pump to boost the drive voltage to the power MOSFET's to higher levels when the input supply is low. A capacitor connected from PVDD to PGND is the storage cap for the pump. A capacitor connected from SW to BOOT2 gets charged every switching cycle while LDRV is high and its charge is dumped on the PVDD capacitor when HDRV goes high. An internal switch disables the charge pump when the voltage on PVDD reaches approximately 4.8 V and enables pumping when PVDD falls to approximately 4.6 V. The high-side driver uses the capacitor from SW to BOOT1 as its power supply. When SW is low, this capacitor charges from the PVDD capacitor. When the SW pin goes high, this capacitor provides above-rail drive for the high-side N-channel FET.

PVDD, BOOT1 and BOOT2 are pre-charged to the VDD voltage during a shutdown condition. For low-input voltage converters, utilizing higher gate threshold voltage MOSFETs, it may be necessary to add a Schottky diode from VDD (anode) to BOOT1 to guarantee sufficient voltage for initial start up. Once switching starts the charge pump reverses bias on the Schottky diode.

When operating the TPS40020 under no load or extremely light-load conditions the controller will be operating in discontinuous Mode (DCM); reverse current is prevented from flowing in the synchronous rectifier. In DCM the on times for both the HDRV and LDRV pulses can become too narrow to provide adequate charging of PVDD and BOOT1 outputs, causing their voltages to collapse. Insufficient PVDD and BOOT1 voltages prevent the external MOSFETs from becoming fully enhanced, causing loss of converter output regulation. Schottky diodes from VIN (anode) to PVDD, and VIN (anode) to BOOT1, as well as a pre-load can be added to maintain PVDD and BOOT1 at voltage levels sufficient enough to fully enhance the external MOSFETs. The amount of pre-load typically ranges from 50 mA to 100 mA depending on operating conditions and external MOSFET selection.

Drivers

The HDRV and LDRV MOSFET drivers are capable of driving gate-to-source voltages up to 5.0 V. Using appropriate MOSFETs, a 25-A converter can be achieved. The LDRV driver switches between VDD and ground, while the HDRV driver is referenced to SW and switches between BOOT1 and SW. The maximum voltage between BOOT1 and SW is 5.0 V when PVDD is in regulation.

APPLICATION INFORMATION

UDG-03031

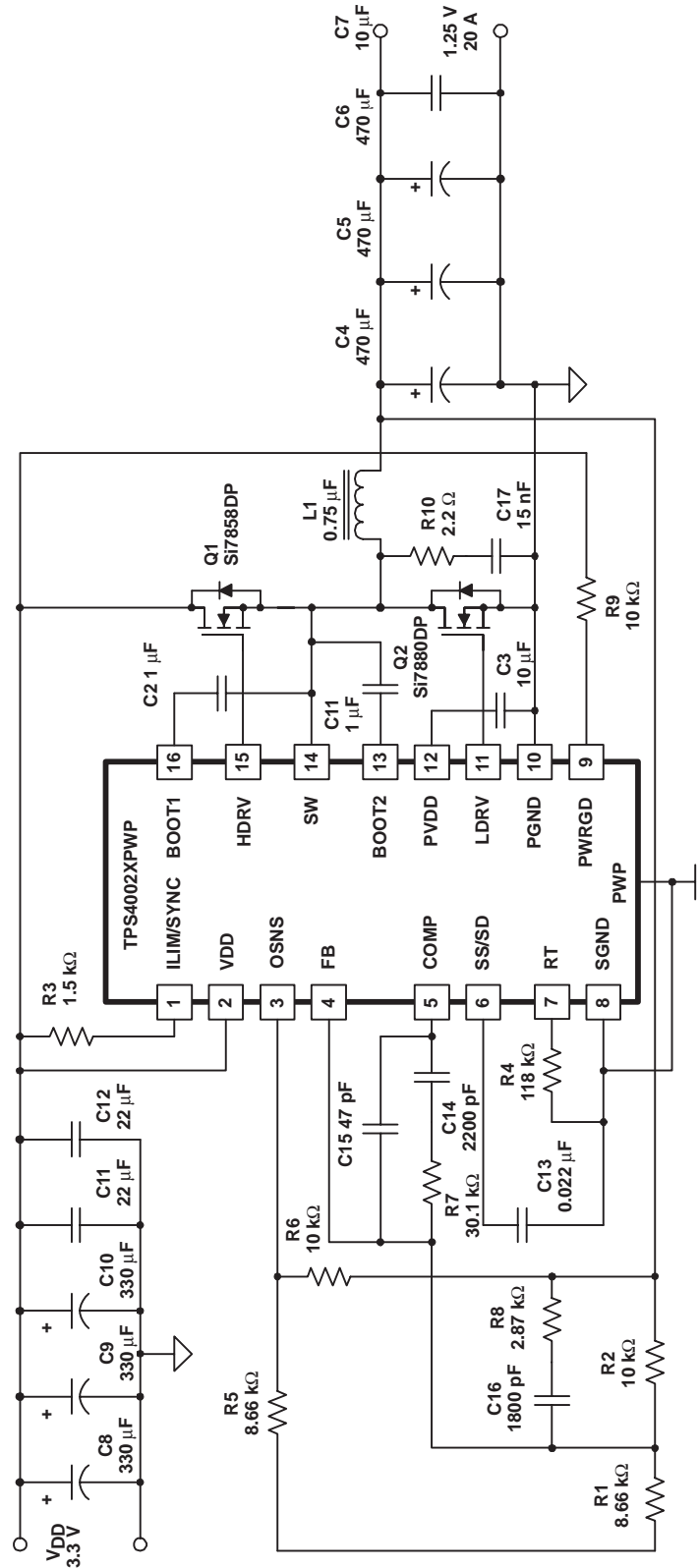
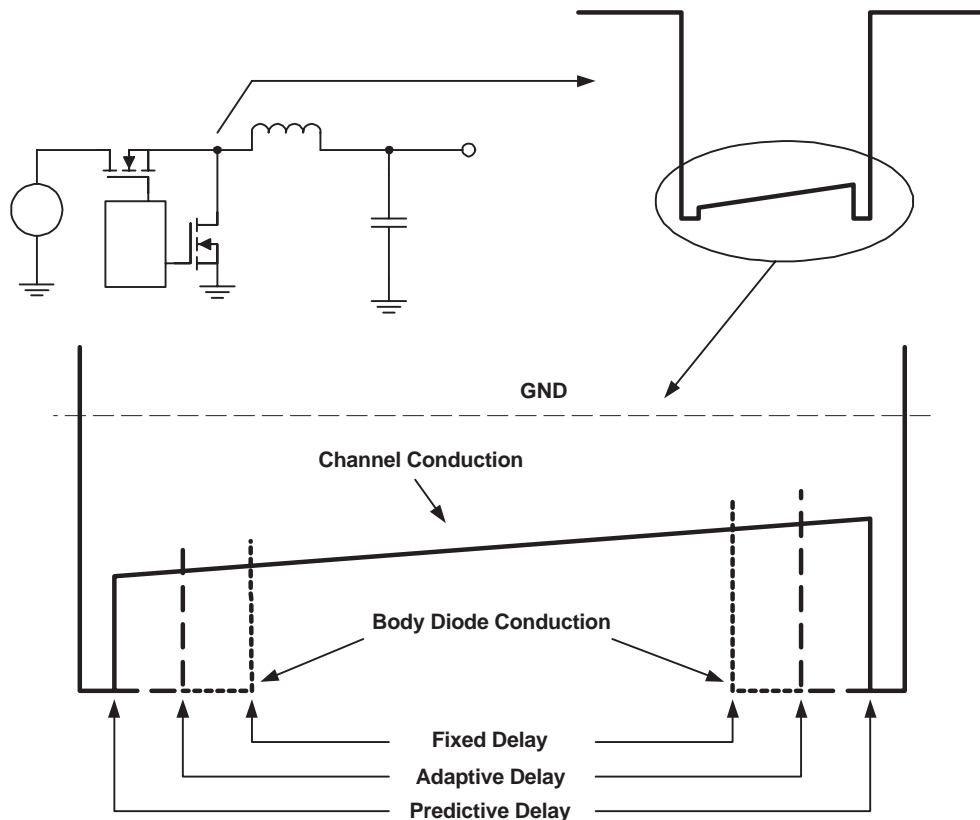

Figure 1. Typical Application

APPLICATION INFORMATION

Synchronous Rectification and Predictive Delay

In a normal buck converter, when the main switch turns off, current is flowing to the load in the inductor. This current cannot be stopped immediately without using infinite voltage. To give this current a path to flow and maintain voltage levels at a safe level, a rectifier or catch device is used. This device can be either a plain diode, or it can be a controlled active device if a control signal is available to drive it. The TPS4002X provides a signal to drive an N-channel MOSFET as a rectifier. This control signal is carefully coordinated with the drive signal for the main switch so that there is absolute minimum dead time from the time that the rectifier FET turns off and the main switch turns on, and minimum delay from when the main switch turns off and the rectifier FET turns on. This TI-patented function, predictive delay, uses information from the current switching cycle to adjust the delays that are used for the next cycle. Figure 2 shows the switch-node voltage waveform for a synchronously rectified buck converter. Illustrated are the relative effects of a fixed delay drive scheme (constant, pre-set delays for the turnoff to turn on intervals), an adaptive delay drive scheme (variable delays based upon voltages sensed on the current switching cycle) and the predictive delay drive scheme. Note that the longer the time spent in diode conduction during the rectifier conduction period, the lower the efficiency. Also, not shown in the figure, is the fact that the predictive delay circuit can actually prevent the body diode from becoming forward biased at all while at the same time avoiding cross conduction or shoot through. This results in a significant power savings when the main FET turns on. There is no reverse recovery loss in the body diode of the rectifier FET.



UDG-01144

Figure 2. Switch Node Waveforms for Synchronous Buck Converter

APPLICATION INFORMATION

Output Short Circuit Protection

Output short circuit protection in the TPS4002x is sensed by looking at the voltage across the main FET while it is on. If the voltage exceeds a pre-set threshold, the current pulse is terminated, and a counter inside the device is incremented. If this counter fills up, a fault condition is declared and the chip disables switching for a period of time and then attempts to restart the converter with a full soft-start cycle. The more detailed explanation follows.

In each switching cycle, a comparator looks at the voltage across the top side FET while it is on. If the voltage across that FET exceeds a programmable threshold voltage, then the current switching pulse is terminated and a 3-bit counter (eight counts) is incremented by one count. If during the switching cycle the top side FET voltage does not exceed a preset threshold, then this counter is decremented by one count. (The counter does not wrap around from seven to zero or from zero to seven). If the counter reaches a full count of seven, the device declares that a fault condition exists at the output of the converter. In this state, switching stops and the soft-start capacitor is discharged. The counter is decremented by one by the soft start cap discharge. When the soft-start capacitor is fully discharged, the discharge circuit is turned off and the cap is allowed to charge up at the nominal charging rate. When the soft-start capacitor reaches approximately 1.3 V, it is discharged again and the overcurrent counter is decremented by one count. The capacitor is charged and discharged, and the counter decremented until the count reaches zero (a total of six times). When this happens, the outputs are again enabled as the soft-start capacitor generates a reference ramp for the converter to follow while attempting to restart. During this soft-start interval (whether or not the controller is attempting to do a fault recovery or starting for the first time), pulse-by-pulse current limiting is in effect, but overcurrent pulses are not counted to declare a fault until the soft-start cycle has been completed. It is possible to have a supply try to bring up a short circuit for the duration of the soft-start period plus seven switching cycles. Power stage designs should take this into account if it makes a difference thermally. Figure 3 shows the details of the overcurrent operation.

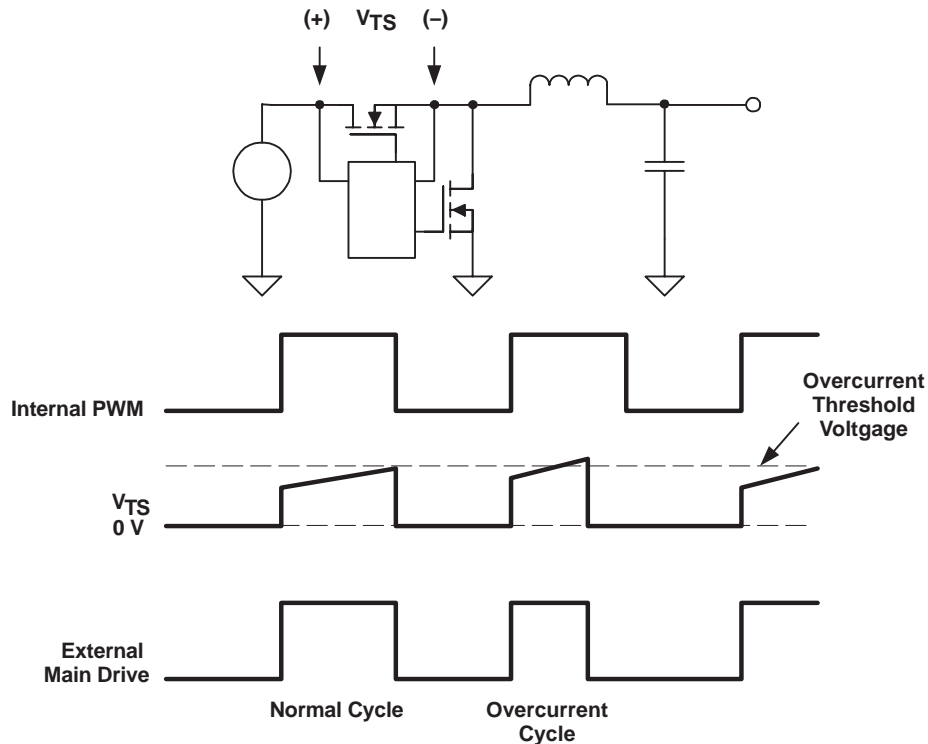

UDG-03029

Figure 3. Switch Node Waveforms for Synchronous Buck Converter

APPLICATION INFORMATION

Figure 4 shows the behavior of key signals during initial startup, during a fault and a successfully fault recovery. At time t_0 , power is applied to the converter. The voltage on the soft-start capacitor (V_{CSS}) begins to ramp up. At t_1 , the soft-start period is over and the converter is regulating its output at the desired voltage level. From t_0 to t_1 , pulse-by-pulse current limiting was in effect, and from t_1 onward, overcurrent pulses are counted for purposes of determining if a fault exists. At t_2 , a heavy overload is applied to the converter. This overload is in excess of the overcurrent threshold, the converter starts limiting current and the output voltage falls to some level depending on the overload applied. During the period from t_2 to t_3 , the counter is counting overcurrent pulses and at time t_3 reaches a full count of 7. The soft-start capacitor is then discharged, the outputs are disabled, the counter decremented, and a fault condition is declared.

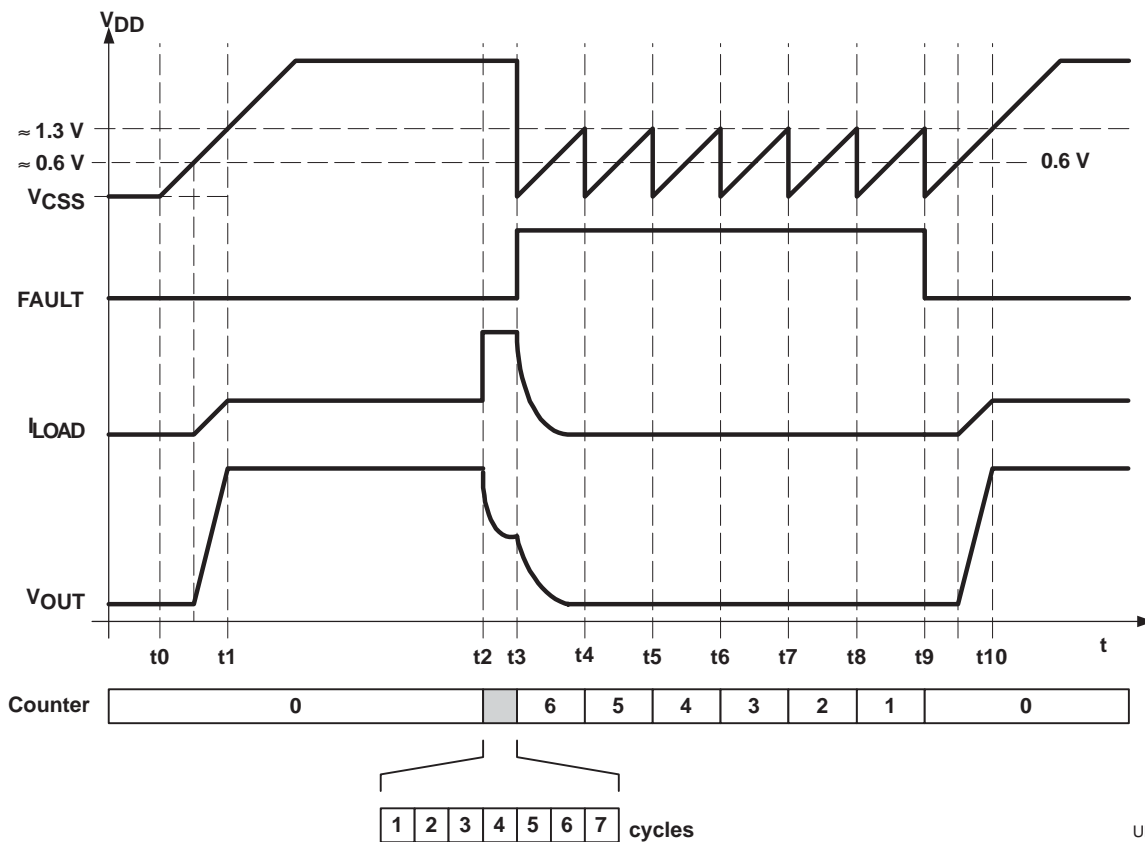

UDG-03187

Figure 4. Overcurrent/Fault Waveforms

When the soft-start capacitor is fully discharged, it begins charging again at the same rate that it does on startup, with a nominal 3- μ A current source. As the capacitor voltage reaches full charge, it is discharged again and the counter is decremented by one count. These transitions occur at t_3 through t_9 . At t_9 , the counter has been decremented to zero. Now the fault logic is cleared, the outputs are enabled and the converter attempts to restart with a full soft-start cycle. The converter comes into regulation at t_{10} .

The internal SS signal is a diode drop below V_{CSS} . When V_{CSS} reaches one diode drop above ground, ($\approx 0.6V$) the output (V_{OUT}) begins its soft-start ramp.

APPLICATION INFORMATION

Setting the Short Circuit Current Limit Threshold

Connecting a resistor from VDD to ILIM sets the current limit. A current sink in the chip causes a voltage drop across the resistor connected to ILIM. This voltage drop is the short circuit current threshold for the part. The current that the ILIM pin sinks is dependent on the value of the resistor connected to RT and is given by:

$$I_{ILIM} = 19.0 \times \frac{0.69 \text{ V}}{R_T} \quad (1)$$

The tolerance of the current sink is too loose to do an accurate current limit. The main purpose is for hard fault protection of the power switches. Given the tolerance of the ILIM sink current, and the $R_{DS(on)}$ range for a MOSFET, it is generally possible to apply a load that thermally damages the converter. This device is intended for embedded converters where load characteristics are defined and can be controlled. A small capacitor can be added between ILIM and VDD for filtering. However, capacitors should not be used if the synchronization function is to be used.

Soft-Start and Shutdown

The soft-start and shutdown functions are common to the SS/SD pin. The voltage at this pin is the controlling voltage sent to the error amplifier during startup. This reduces the transient current required to charge the output capacitor at startup, and allows for a smooth startup with no overshoot of the output voltage. A shutdown feature can be implemented as shown in Figure 5.

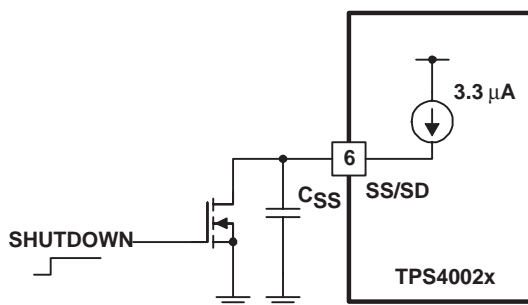

Figure 5. Shutdown Implementation

Switching Frequency

The switching frequency is programmed by a resistor from RT to SGND. Nominal switching frequency can be calculated by:

$$R_T \text{ (k}\Omega\text{)} = \frac{37.736 \times 10^3}{f_{OSC} \text{ (kHz)}} - 5.09 \text{ (k}\Omega\text{)} \quad (2)$$

APPLICATION INFORMATION

Synchronization

The TPS4002x can be synchronized to an external reference frequency higher than the free running oscillator frequency. The recommended method is to use a diode and a push pull drive signal as shown in Figure 6.

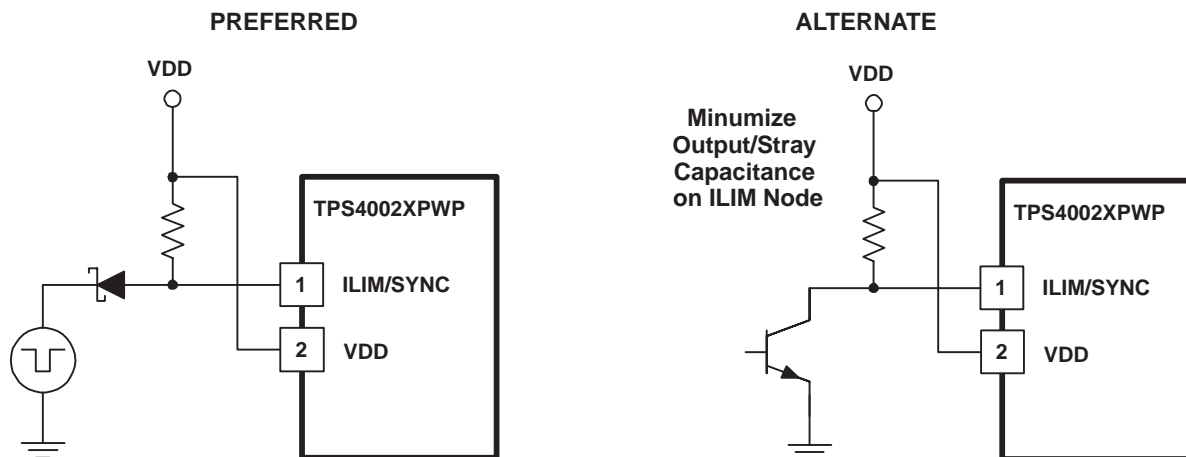

UDG-03032

Figure 6. Synchronization Methods

This design allows synchronization up to the maximum operating frequency of 1 MHz. For best results the nominal operating frequency of a converter that is to be synchronized should be kept as close as practicable to the synchronization frequency to avoid excessive noise induced pulse width jitter. A good target is to shoot for the free run frequency to be 80% of the synchronized frequency. This ensures that the synchronization source is the frequency determining element in the system and not to adversely affect noise immunity.

Other methods of implementing the synchronization function include using an open collector or open drain output device directly, or discreet devices to pull the ILIM/SYNC pin down. These do work but performance can suffer at high frequency because the ILIM/SYNC pin must rise to $(V_{DD} - 1.0 \text{ V})$ before the next switching cycle begins. Any time that this requires is directly subtracted from the maximum pulse width available and should be considered when choosing devices to drive ILIM/SYNC. Consequently, the lowest output capacitance devices work best.

During a synchronization cycle, the current sink on the ILIM/SYNC pin becomes disabled when ILIM/SYNC is pulled below 1.0 V. The ILIM/SYNC current sink remains disabled until ILIM/SYNC reaches $(V_{DD} - 1.0 \text{ V})$ This removes the load on the ILIM/SYNC pin to allow the voltage to slew rapidly depending on the ILIM resistor and any stray capacitance on the pin. To maximize this slew rate, minimize stray capacitance on this pin.

APPLICATION INFORMATION

Transient Comparators and Power Good

The TPS4002x makes use of a separate pin, OSNS, to monitor output voltage for these two functions. In normal operation, OSNS is connected to the output via a resistor divider. It is important to make this divider the same ratio as the divider for the feedback network so that in normal operation the voltage at OSNS is the same as the voltage at FB, 0.69 V nominal.

The PWRGD pin is an open drain output that is pulled low when the voltage at OSNS falls outside $0.69\text{ V} \pm 4.6\%$ (approximately). A delay has been purposely built into the PWRGD pin pulling low in response to an out of band voltage on OSNS, to minimize the need for filtering the signal in the event of a noise glitch causing a brief out of band OSNS voltage. The PWRGD signal returns to high when the OSNS signal returns to approximately $\pm 1\%$ of nominal ($0.69\text{ V} \pm 1\%$).

The transient comparators override the conventional voltage control loop when the output voltage exceeds a $\pm 4.6\%$ window. If the output transition is high (i.e. load steps down from 90% load to 10% load) then the HDRV gate drive is terminated, 0% duty cycle, the LDRV gate drive is turned on to sink output current until V_{OUT} returns to within 1% of nominal. Conversely when V_{OUT} drops outside the window (i.e. step load increases from 10% load to 90% load) HDRV increases to maximum duty cycle until V_{OUT} returns to within 1% of nominal. (See Figure 7.)

During start-up, the transient comparators control the state of PWRGD as previously described. However, the operation of the gate drive outputs is not affected. (See Figure 8)

The transient comparators provide an improvement in load transient recovery time if used properly. In some situations, recovery time may be one half of the time required without transient comparators. Keep in mind that the transient comparator concept is a double-edged sword. While they provide improved transient recovery time, they can also lead to instability if incorrectly applied. For proper functionality, design a feedback loop for the converter that places the closed loop unity gain frequency at least five times higher than the 0 dB frequency of the output L-C filter. If not, the feedback loop cannot respond to the ring of the L-C on a transient event. The ring is likely to be large enough to disturb the transient comparators and the result is a power oscillator. Another helpful action is to ground the feedback loop divider and the OSNS divider at the SGND pin. Make sure both dividers measure the same physical location on the output bus. These help avoid problems with resistive drops at higher loads causing problems.

Connecting OSNS to VDD disables the transient comparators. This also disables the PWRGD function. Alternatively, OSNS and FB can be tied together. This connection allows a proper PWRGD at startup, though transient performance diminishes.

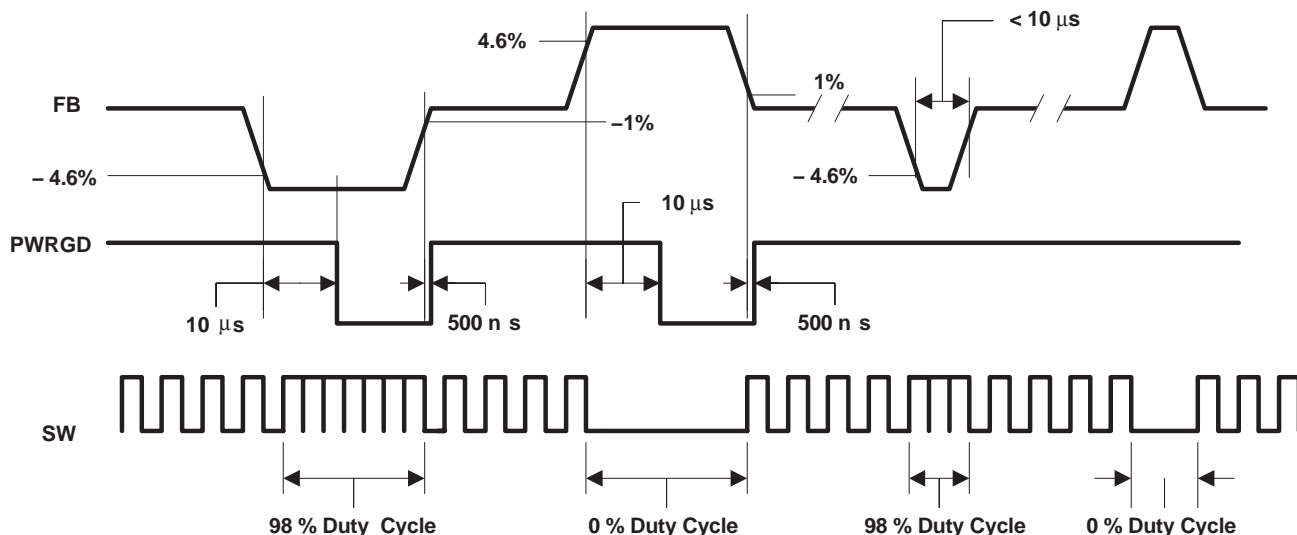

UDG-03181

Figure 7. Duty Cycle Waveforms

APPLICATION INFORMATION

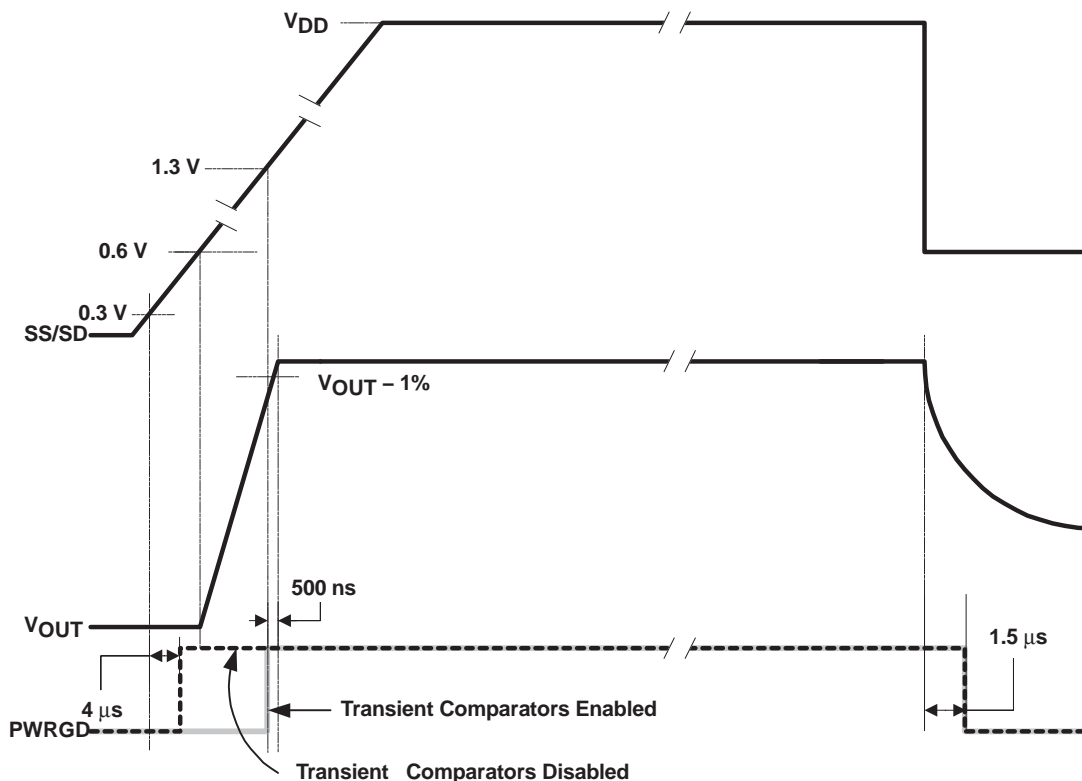

UDG-03181

Figure 8. Transient Comparator Waveforms

Layout Considerations

Successful operation of the TPS4002x family of controllers is dependent upon the proper converter layout and grounding techniques. High current returns for the SR MOSFET's source, input capacitance, output capacitance, PVDD capacitance, and input bypass capacitors (if applicable), should be kept on a single ground plane or wide trace connected to the PGND (pin10) through a short wide trace. Control components connected to signal ground, as well as the PowerPad thermal pad, should be connected to a single ground plane connected to SGND (Pin 8) through a short trace. SGND and PGND should be connected at a single point using a narrow trace.

Proper operation of Predictive Gate Drive™ technology and IZERO functions are dependent upon detecting low-voltage thresholds on the SW node. To ensure that the signal at the SW pin accurately represents the voltage at the main switching node, the connection from SW (pin 14) to the main switching node of the converter should be kept as short and wide as possible and should ideally be kept on the top level with the power components. If the SW trace must traverse multiple board layers between the TPS4002x and the main switching node, multiple vias should be used to minimize the trace impedance.

Gate drive outputs, LDRV and HDRV (pins 11 and 15, respectively) should be kept as short as possible to minimize inductances in the traces. If the gate drive outputs need to traverse multiple board layers multiple vias should be used.

Charge pump components, BOOT1, BOOT2, PVDD, and any input bypass capacitors (if required), should be kept as close as possible to their respective pins. Ceramic bypass capacitors should be used if the input capacitors are located more than a couple of inches away from the TPS4002X. If a bypass capacitor is not needed the trace from the input capacitors to VDD (pin2) should be kept as short and wide as possible to minimize trace impedance. If multiple board layers are traversed multiple vias should be used.

APPLICATION INFORMATION

Manufacturer's instructions should be followed for proper layout of the external MOSFETs. Thermal impedances given in the manufacturer's datasheets are for a given mounting technique with a specified surface area under the drain of the MOSFET. PowerPAD package information can be found in the APPLICATION INFORMATION section of this datasheet.

Refer to TPS40021 EVM-001 High Efficiency Synchronous Buck Converter with PWM Controller Evaluation Module (HPA009) User's Guide, (Literature No. sluu144A) for a typical board layout.

The PowerPAD package provides low thermal impedance for heat removal from the device. The PowerPAD derives its name and low thermal impedance from the large bonding pad on the bottom of the device. The circuit board must have an area of solder-tinned-copper underneath the package. The dimensions of this area depends on the size of the PowerPAD package. For a 16-pin TSSOP (PWP) package the area is 5 mm x 3.4 mm [3].

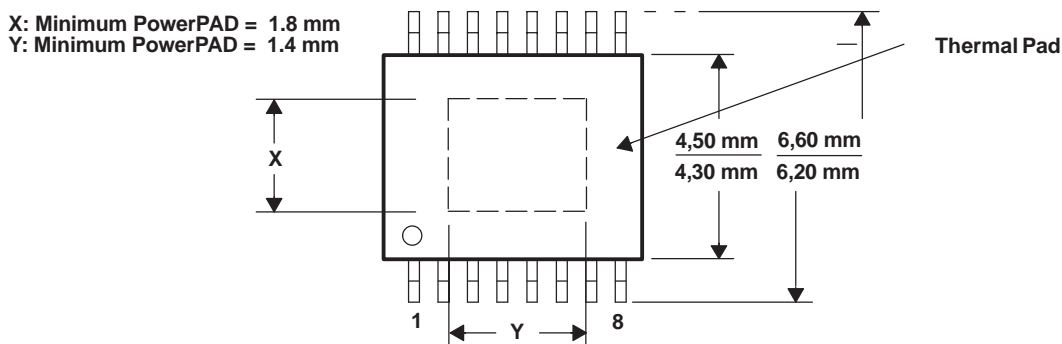

Figure 9. PowerPAD Dimensions

Thermal vias connect this area to internal or external copper planes and should have a drill diameter sufficiently small so that the via hole is effectively plugged when the barrel of the via is plated with copper. This plug is needed to prevent wicking the solder away from the interface between the package body and the solder-tinned area under the device during solder reflow. Drill diameters of 0.33 mm (13 mils) works well when 1-oz copper is plated at the surface of the board while simultaneously plating the barrel of the via. If the thermal vias are not plugged when the copper plating is performed, then a solder mask material should be used to cap the vias with a diameter equal to the via diameter of 0.1 mm minimum. This capping prevents the solder from being wicked through the thermal vias and potentially creating a solder void under the package. Refer to *PowerPAD Thermally Enhanced Package*^[3] for more information on the PowerPAD package.

TYPICAL CHARACTERISTICS

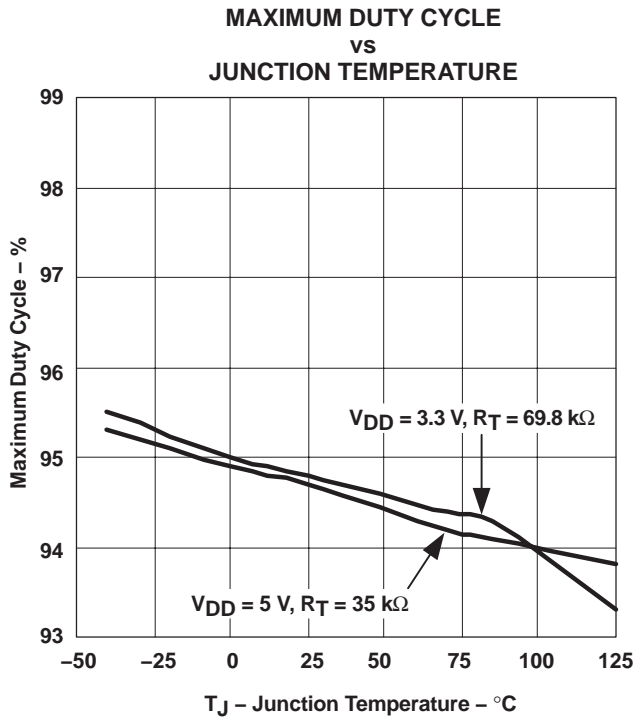

Figure 10

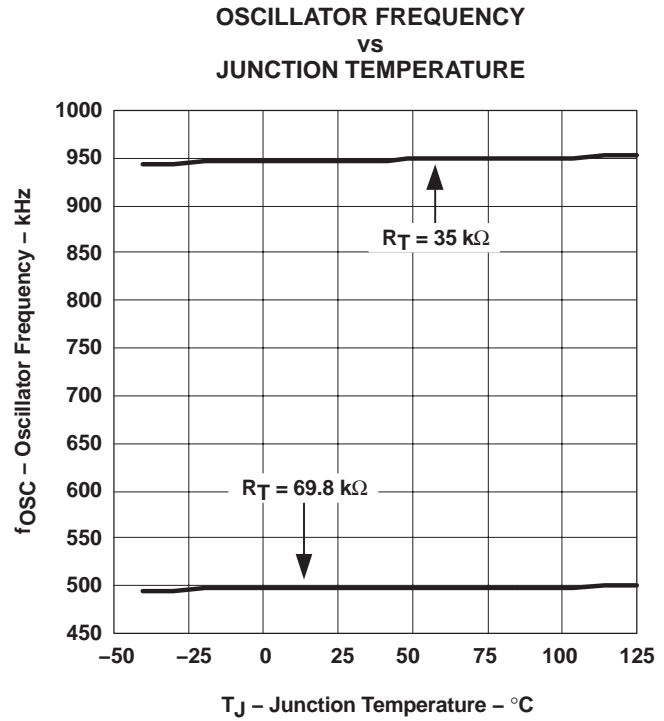

Figure 11

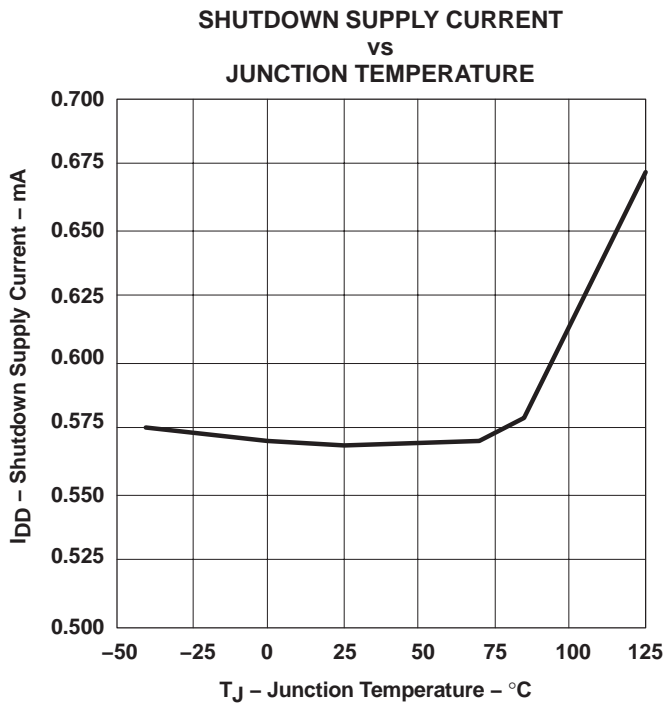

Figure 12

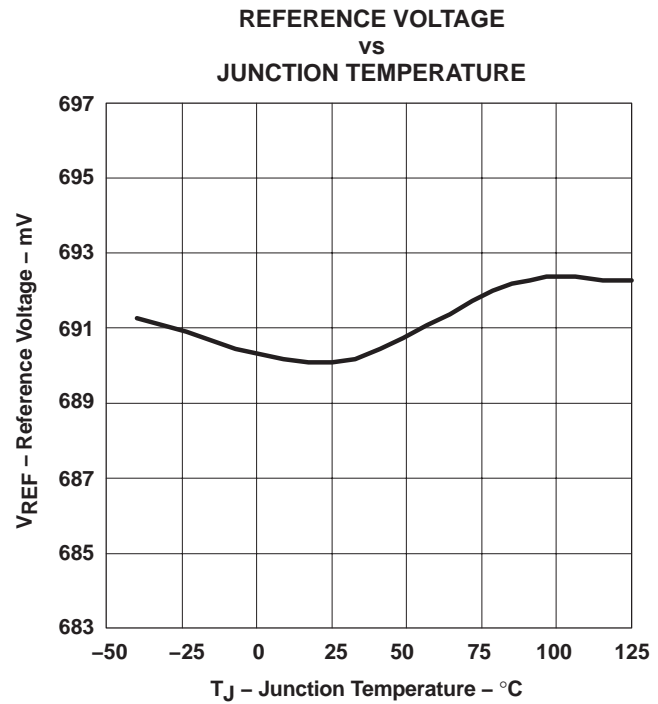

Figure 13

TYPICAL CHARACTERISTICS

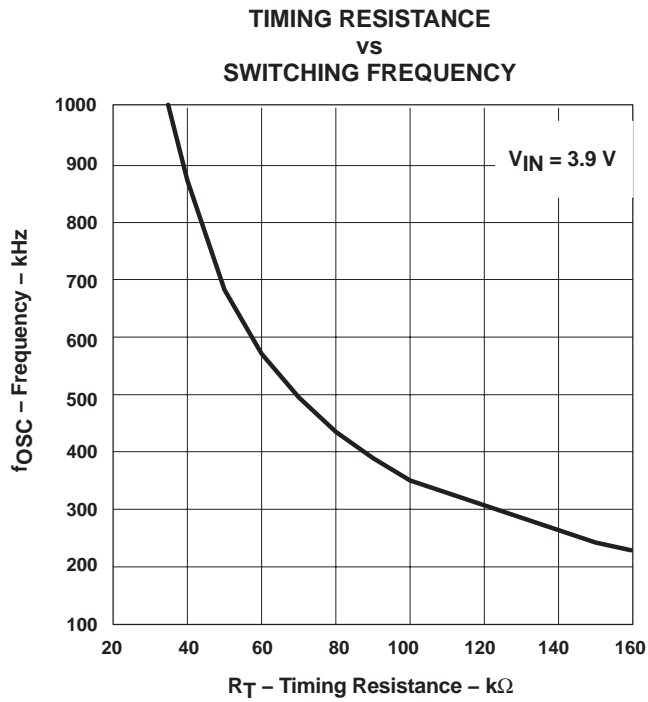

Figure 14

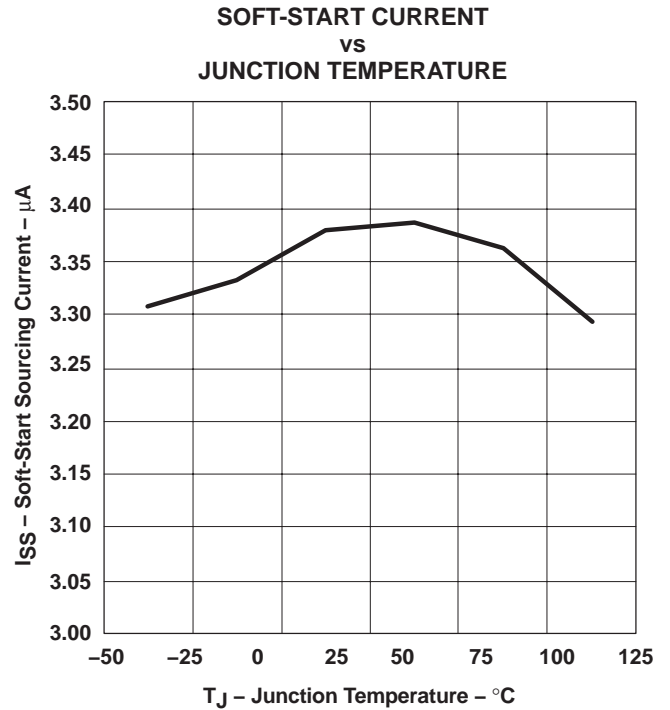

Figure 15

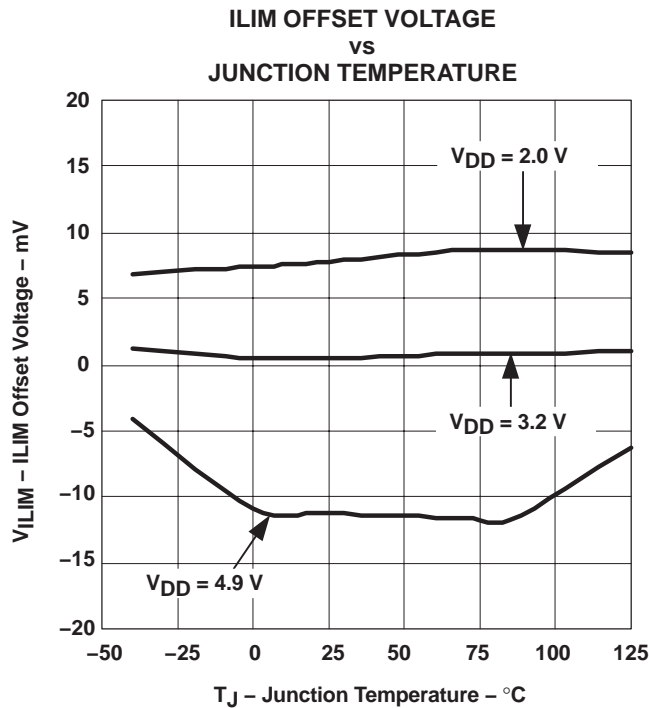

Figure 16

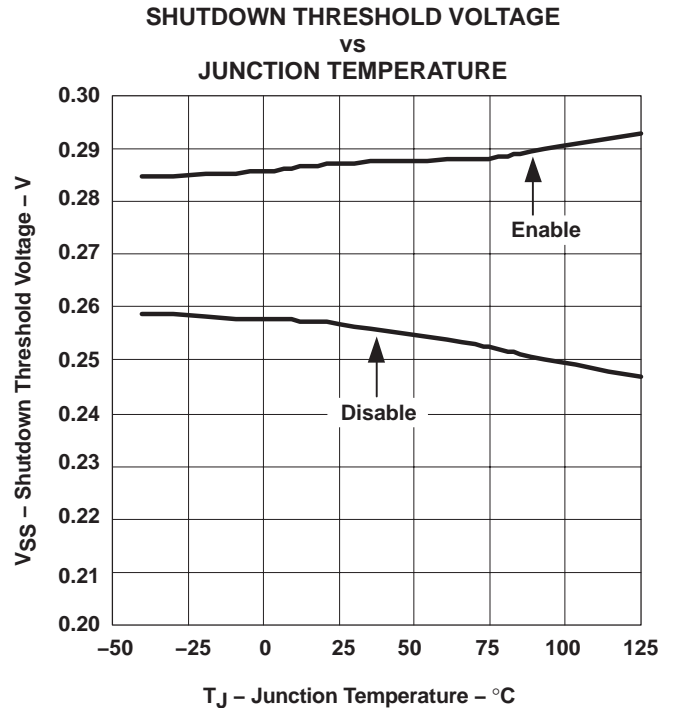

Figure 17

TYPICAL CHARACTERISTICS

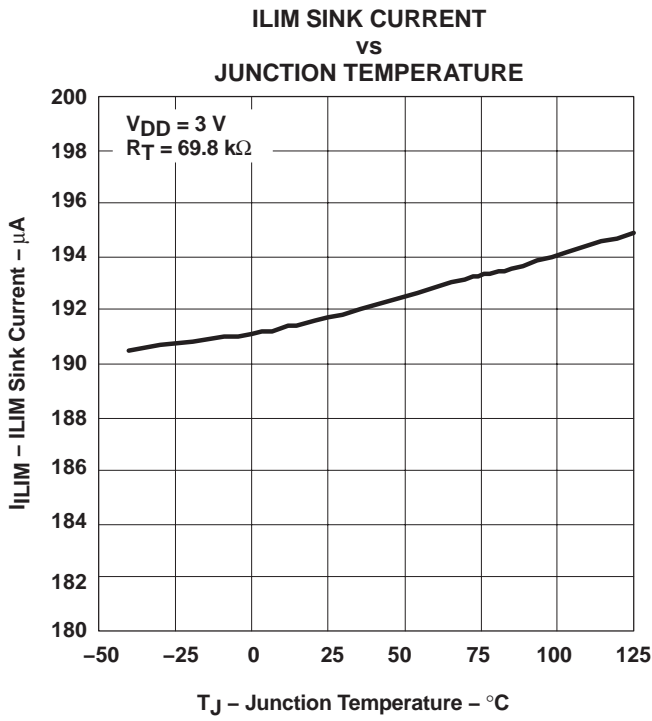

Figure 18

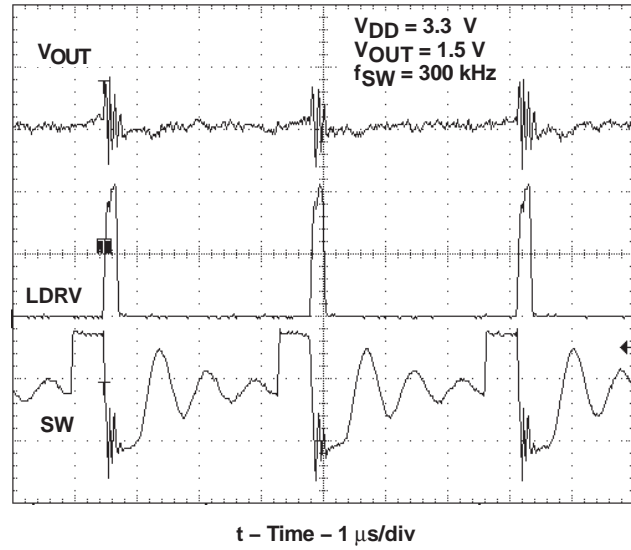

Figure 19. TPS40020 Discontinuous Mode (DCM)

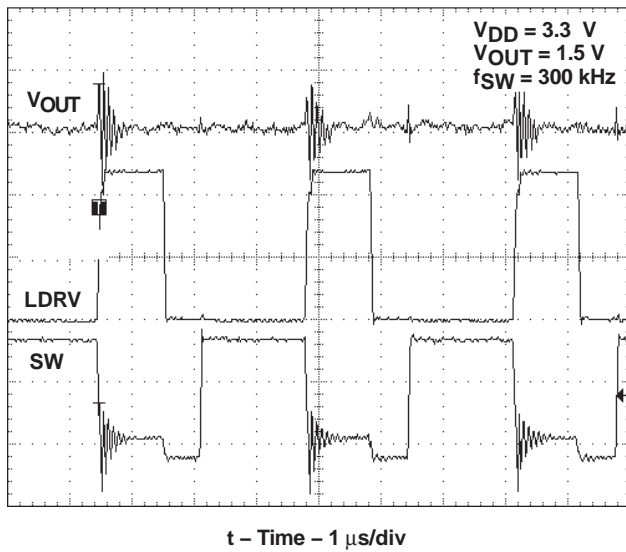

Figure 20. TPS40020 I_{ZERO} Detection - DCM

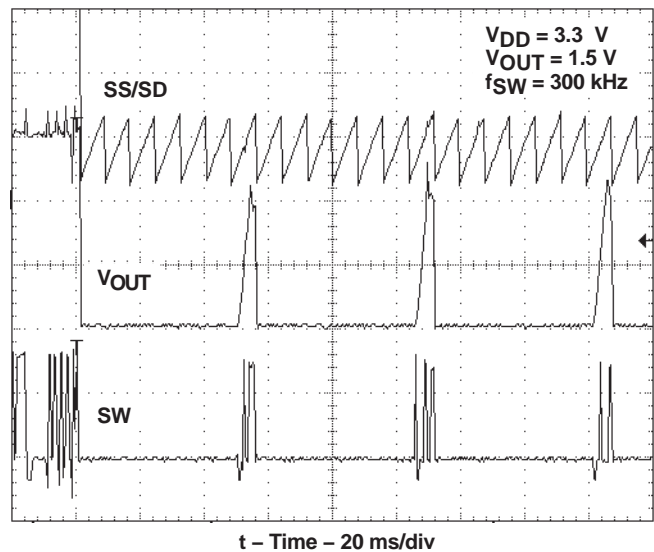
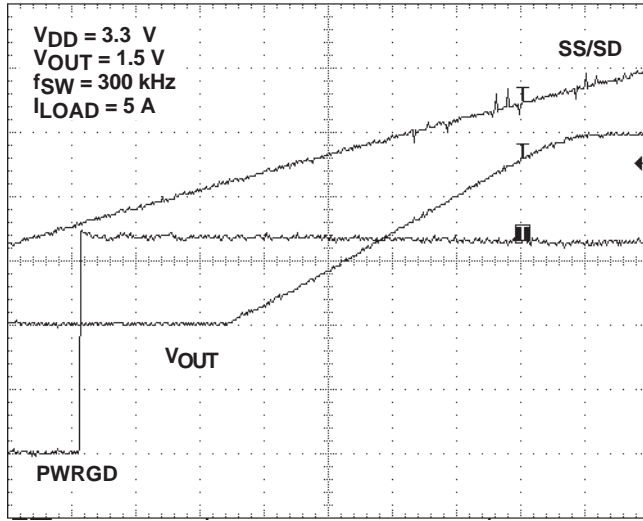

Figure 21. Output Current Fault Operation

TYPICAL CHARACTERISTICS



t – Time – 1 ms/div

Figure 22. Start-Up Operation Without Transient Comparators

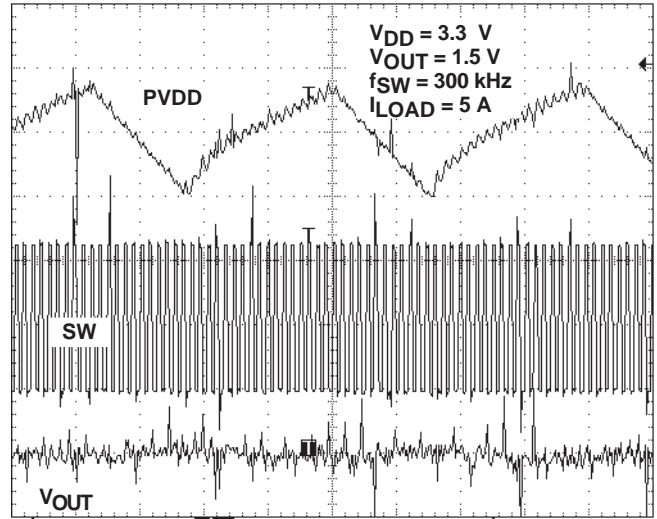

t – Time – 25 μ s/div

Figure 23. PVDD Hysteresis

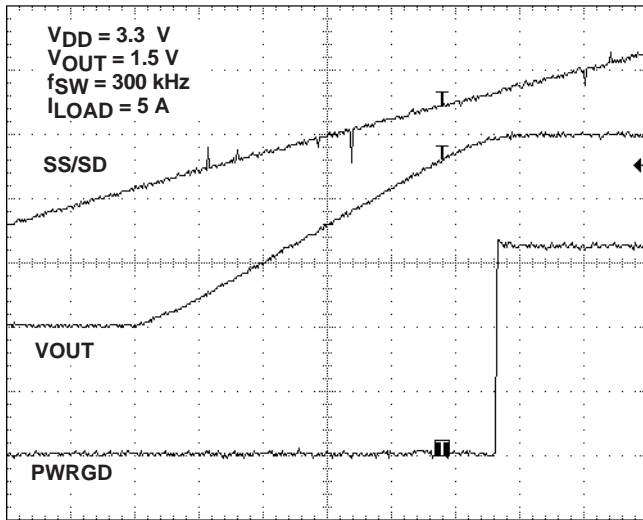

t – Time – 1 ms/div

Figure 24. Start-Up Operation With Transient Comparators

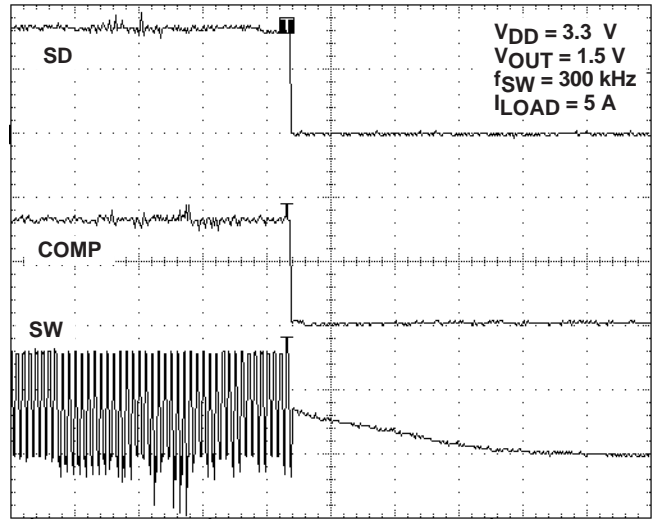

t – Time – 200 μ s/div

Figure 25. COMP Shutdown Operation

TYPICAL CHARACTERISTICS

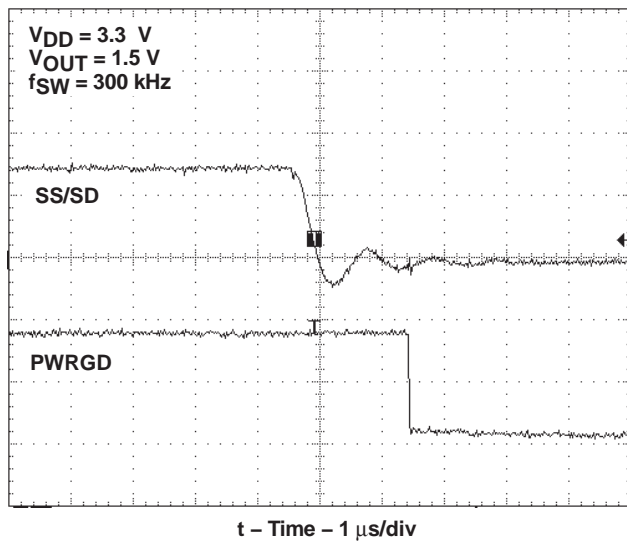

Figure 26. PWRGD Shutdown Operation

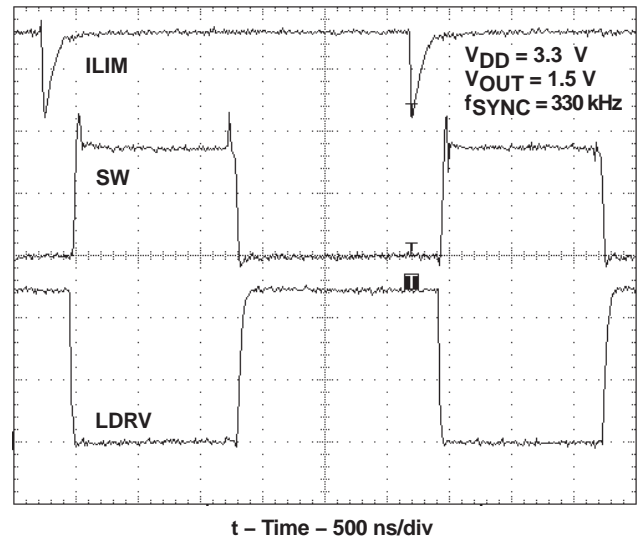

Figure 27. External Synchronization

REFERENCE DESIGN

This design used the TPS40020 PWM controller to facilitate a step-down application from 3.3-V to 1.5 V. (see Figure 29) Design specifications include:

- Input voltage: $2.5\text{ V} \leq V_{IN} \leq 5.0\text{ V}$
- Nominal voltage: 3.3 V
- Output voltage V_{OUT} : 1.5 V
- Output current I_{OUT} : 20 A
- Switching frequency: 300 kHz

DESIGN PROCEDURE

Setting the Frequency

Choosing the optimum switching frequency is complicated. The higher the frequency, the smaller the inductance and capacitance needed, so the smaller the size, but then the the switching losses are higher, the efficiency is poorer. For this evaluation module, 300 kHz is chosen for reasonable efficiency and size.

A resistor R_T , which is connected from pin 7 to ground, programs the oscillator frequency. The approximate operating frequency is calculated in equation (3)

$$R_T (\text{k}\Omega) = \frac{37.736 \times 10^3}{f_{OSC}(\text{kHz})} - 5.09 (\text{k}\Omega) \quad (3)$$

Using equation (2), R_T is calculated to be 120 k Ω and a 118-k Ω resistor is chosen for 300 kHz operation.

Inductance Value

The inductance value can be calculated by equation (2).

$$L_{(\text{min})} = \frac{V_{OUT}}{f \times I_{RIPPLE}} \times \left(1 - \frac{V_{OUT}}{V_{IN(\text{max})}} \right) \quad (4)$$

where I_{RIPPLE} is the ripple current flowing through the inductor, which affects the output voltage ripple and core losses.

Based on 20% ripple current and 300 kHz, the inductance value is calculated to 0.76 μH and a 0.75- μH inductor (part number is CDEP149-0R7) is chosen. The ESR of this inductor is 1.1 m Ω and the loss is 440 mW, which is approximately 1.5% of output power.

$$C_{OUT(\text{min})} = \frac{I_{RIPPLE}}{8 \times f \times V_{RIPPLE}} \quad (5)$$

$$ESR_{OUT} = \frac{V_{RIPPLE}}{I_{RIPPLE}} \quad (6)$$

With 1% output voltage ripple, the needed capacitance is at least 114 μF and its ESR should be less than 3.7 m Ω . Three 2-V, 470- μF , POSCAP capacitors from Sanyo are used. The ESR is 10 m Ω each.

The required input capacitance is calculated in equation (5). The calculated value is approximately 348 μF . Three 6.0-V, 330- μF POSCAP capacitors with 10 m Ω ESR are used to handle 10 A of RMS input current. Additionally, two ceramic capacitors are used to reduce the switching ripple current.

$$C_{IN(\text{min})} = I_{OUT(\text{max})} \times D_{(\text{max})} \times \frac{T_S}{V_{RIPPLE}} \quad (7)$$

REFERENCE DESIGN

Input and Output Capacitors

The output capacitance and its ESR needed are calculated in equations (5) and (6).

Compensation Design

Voltage-mode control is used in this evaluation module, using R2, R7, R8, C14, C15, and C16 to form a Type-III compensator network. The L-C frequency of the power stage is approximately 4.9-kHz and the ESR-zero is around 34 kHz. The overall crossover frequency, f_{0db} , is chosen at 43-kHz for reasonable transient response and stability. Two zeros f_{Z1} and f_{Z2} from the compensator are set at 2.4 kHz and 4 kHz. The two poles, f_{P1} and f_{P2} are set at 34 kHz and 115 kHz. The frequency of poles and zeros are defined by the following equations:

$$f_{Z1} = \frac{1}{2\pi \times R7 \times C14} \quad (8)$$

$$f_{Z2} = \frac{1}{2\pi \times R2 \times C11} \quad (\text{assuming } R2 \gg R8) \quad (9)$$

$$f_{P1} = \frac{1}{2\pi \times R8 \times C11} \quad (10)$$

$$f_{P2} = \frac{1}{2\pi \times R7 \times C12} \quad (\text{assuming } C14 \gg C12) \quad (11)$$

The transfer function for the compensator is calculated in equation (10).

$$A(s) = \frac{(1 + s \times C14 \times R7) \times [1 + s \times C11 \times (R2 + R3)]}{s \times R2 \times C14 \times \left[\left(1 + \frac{C12}{C14}\right) + s \times R7 \times C12 \right] \times (1 + s \times R8 \times C11)} \quad (12)$$

Figure 30 shows the close loop gain and phase. The overall crossover frequency is approximately 30 kHz. The phase margin is 57°.

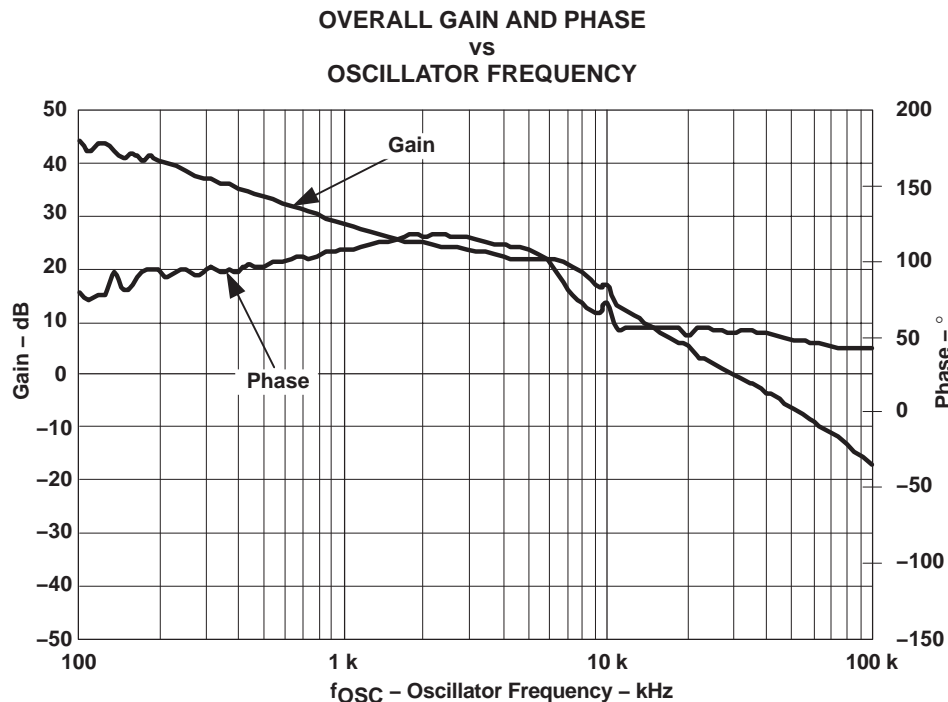

Figure 29.

REFERENCE DESIGN

MOSFETs and Diodes

For a 1.5-V output voltage, the lower the $R_{DS(on)}$ of the MOSFET, the higher the efficiency. Due to the high current and high conduction loss, the MOSFET should have very low conduction resistance ($R_{DS(on)}$) and thermal resistance. Si7858DP is chosen for its low $R_{DS(on)}$ (between 3 m Ω and 4 m Ω) and Power-Pak package.

Current Limiting

Resistor R3 sets the over current limit threshold. The $R_{DS(on)}$ of the upper MOSFET is used as a current sensor. The current limit is initialized at 40% above the maximum output current, $I_{OUT(max)}$, which is 28 A. Then R3 can be calculated in equation (11) and yields a value of 1.43 k Ω .

$$I_{LIM} = \left(20 \times \frac{V_{REF}}{R4} \right) = \left(20 \times \frac{0.7 \text{ V}}{118 \text{ k}\Omega} \right) = 118.6 \text{ } (\mu\text{A}) \quad (13)$$

$$R3 = \frac{K \times R_{DS(on)} \times I_{OUT}}{I_{LIM} (\mu\text{A})} = \frac{1.5 \times 4 (\mu\Omega) \times 28 \text{ A}}{118.6 (\mu\text{A})} = 1.43 \text{ (k}\Omega) \quad (14)$$

where

- $R_{DS(on)}$ is the on-resistor of Q1 (4 m Ω)
- Temperature coefficient, $K=1.5$
- $V_{REF}=0.7 \text{ V}$
- $R4=118 \text{ k}\Omega$

Voltage Sense Regulator

R1 and R2 operate as the output voltage divider. The internal reference voltage (V_{REF}) is 0.7 V. The relationship between the output voltage and divider is described in equation (8). Using a 10-k Ω resistor for R2 and 1.5-V output regulation, R1 is calculated as 8.66 k Ω .

$$\frac{V_{REF}}{R1} = \frac{V_{OUT}}{R1 + R2} = \frac{0.7 \text{ V}}{R1} = \frac{1.5 \text{ V}}{R1 + 10 \text{ k}\Omega} = 8.66 \text{ k}\Omega \quad (15)$$

Transient Comparator

The output voltage transient comparators provide a quick response, first strike, approach to output voltage transients. The output voltage is sensed through a resistor divider at the OSNS pin, using R5 and R6 shown in Figure 28. If an overvoltage condition is detected, the HDRV gate drive is shut off and the LDRV gate drive is turned on until the output is returned to regulation. Similarly, if an output undervoltage condition is sensed, the HDRV gate drive goes to 95% duty cycle to pump the output back up quickly. The voltage divider should be exactly the same as resistors R1 and R2 discussed previously. Resistor R5=8.66 k Ω and R6=10 k Ω in this evaluation module.

REFERENCE DESIGN

TEST RESULTS

Efficiency Curves

The tested efficiency at different loads and input voltages are shown in Figure 30. The maximum efficiency is as high as 93% at 1.5-V output. The efficiency is around 88% when the load current (I_{LOAD}) is 20 A.

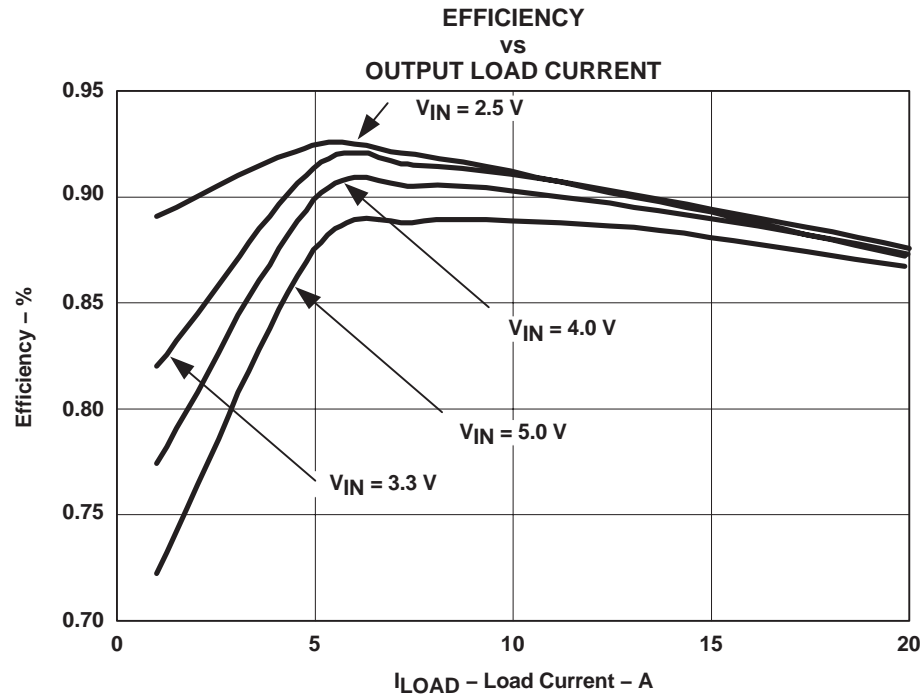
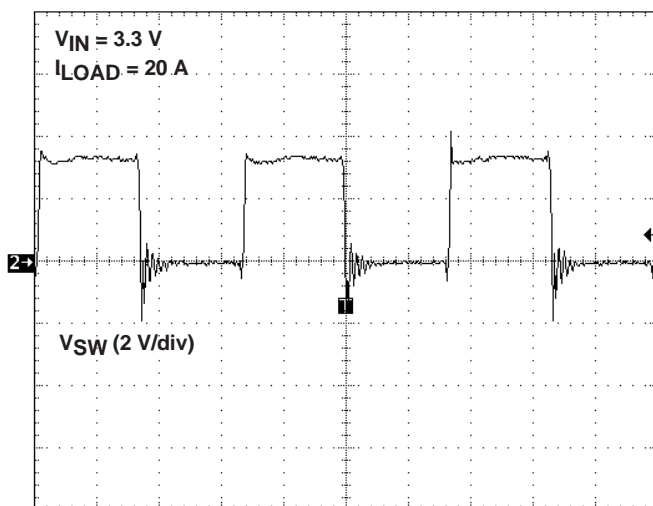

Figure 30.

Typical Operating Waveforms

Typical operating waveforms are shown in Figure 31 and 32.



t – Time – 1 μ s/div
Figure 31

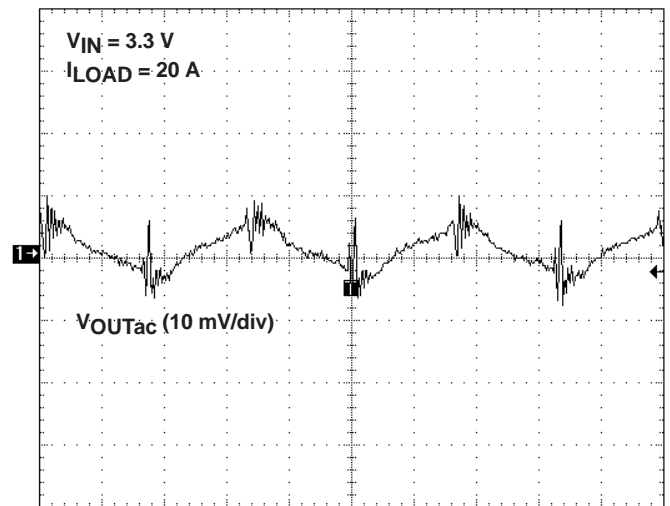

t – Time – 1 μ s/div
Figure 32

REFERENCE DESIGN

Transient Response and Output Ripple Voltage

The output ripple is about 15 mV_{P-P} at 20-A output. When the load changes from 4 A to 20 A, the overshooting voltage is about 35 mV.

Figures 33 and 34 show the transient waveform with and without the transient comparator. Using the transient comparator yields a settling time of 10- μ s faster than without.

The output ripple is about 15 mV_{P-P} at 20-A output which is shown in Figure 33. When the load changes from 0 A to 13 A, the overshoot voltage is approximately 80 mV, and the undershoot is approximately 60 mV as shown in Figure 35. When the transient comparator is triggered, the powergood (PWRGD) signal goes low.

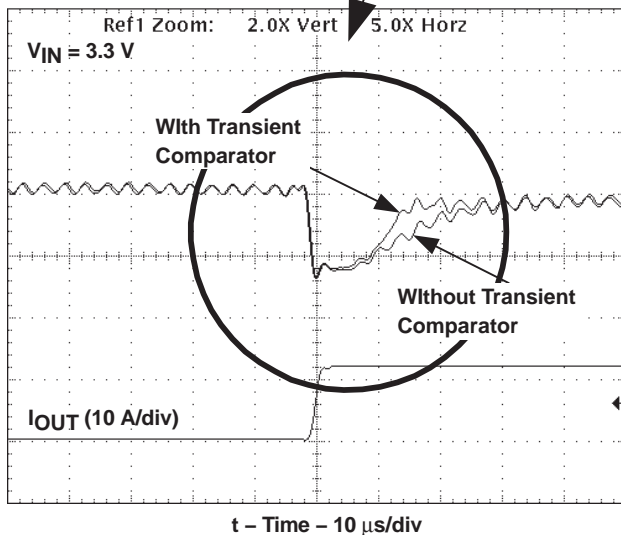
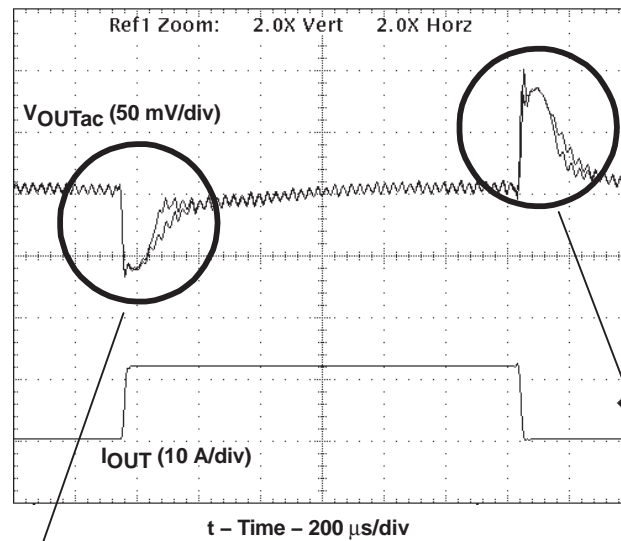

Figure 33. Transient Response Undershoot

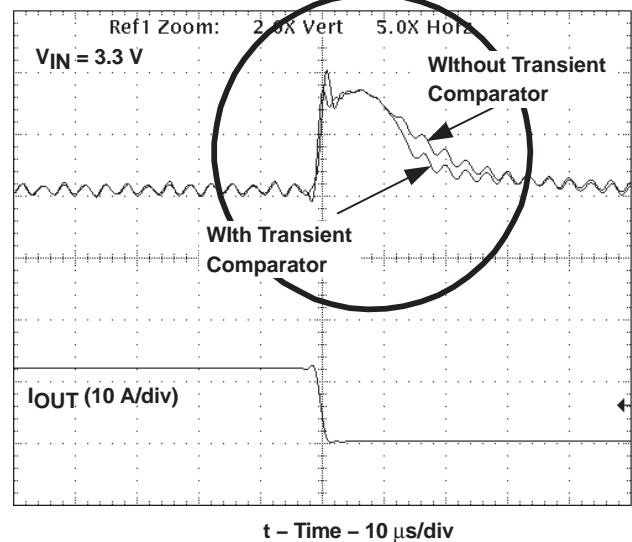

Figure 34. Transient Response Overshoot

REFERENCE DESIGN

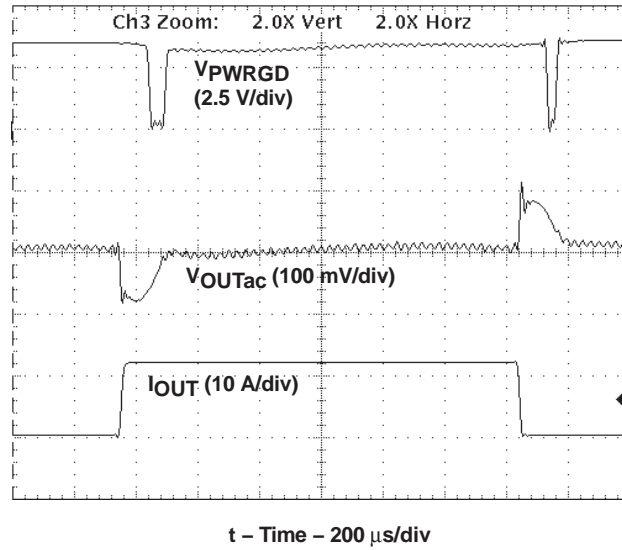

Figure 35. Transient Response

IMPORTANT NOTICE

Texas Instruments Incorporated and its subsidiaries (TI) reserve the right to make corrections, modifications, enhancements, improvements, and other changes to its products and services at any time and to discontinue any product or service without notice. Customers should obtain the latest relevant information before placing orders and should verify that such information is current and complete. All products are sold subject to TI's terms and conditions of sale supplied at the time of order acknowledgment.

TI warrants performance of its hardware products to the specifications applicable at the time of sale in accordance with TI's standard warranty. Testing and other quality control techniques are used to the extent TI deems necessary to support this warranty. Except where mandated by government requirements, testing of all parameters of each product is not necessarily performed.

TI assumes no liability for applications assistance or customer product design. Customers are responsible for their products and applications using TI components. To minimize the risks associated with customer products and applications, customers should provide adequate design and operating safeguards.

TI does not warrant or represent that any license, either express or implied, is granted under any TI patent right, copyright, mask work right, or other TI intellectual property right relating to any combination, machine, or process in which TI products or services are used. Information published by TI regarding third-party products or services does not constitute a license from TI to use such products or services or a warranty or endorsement thereof. Use of such information may require a license from a third party under the patents or other intellectual property of the third party, or a license from TI under the patents or other intellectual property of TI.

Reproduction of information in TI data books or data sheets is permissible only if reproduction is without alteration and is accompanied by all associated warranties, conditions, limitations, and notices. Reproduction of this information with alteration is an unfair and deceptive business practice. TI is not responsible or liable for such altered documentation.

Resale of TI products or services with statements different from or beyond the parameters stated by TI for that product or service voids all express and any implied warranties for the associated TI product or service and is an unfair and deceptive business practice. TI is not responsible or liable for any such statements.

Following are URLs where you can obtain information on other Texas Instruments products and application solutions:

Products		Applications	
Amplifiers	amplifier.ti.com	Audio	www.ti.com/audio
Data Converters	dataconverter.ti.com	Automotive	www.ti.com/automotive
DSP	dsp.ti.com	Broadband	www.ti.com/broadband
Interface	interface.ti.com	Digital Control	www.ti.com/digitalcontrol
Logic	logic.ti.com	Military	www.ti.com/military
Power Mgmt	power.ti.com	Optical Networking	www.ti.com/opticalnetwork
Microcontrollers	microcontroller.ti.com	Security	www.ti.com/security
		Telephony	www.ti.com/telephony
		Video & Imaging	www.ti.com/video
		Wireless	www.ti.com/wireless

Mailing Address: Texas Instruments
Post Office Box 655303 Dallas, Texas 75265