

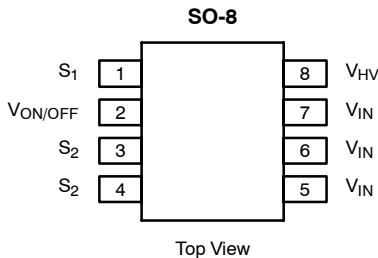

## Load Switch with Level-Shift

PRODUCT SUMMARY		
$V_{DS2}$ (V)	$r_{DS(on)}$ ( $\Omega$ )	$I_D$ (A)
30	0.024 @ $V_{GS2} = 10$ V	5.5
	0.035 @ $V_{GS2} = 4.5$ V	4.5



Ordering Information: Si4702DY  
Si4702DY-T1 (with Tape and Reel)

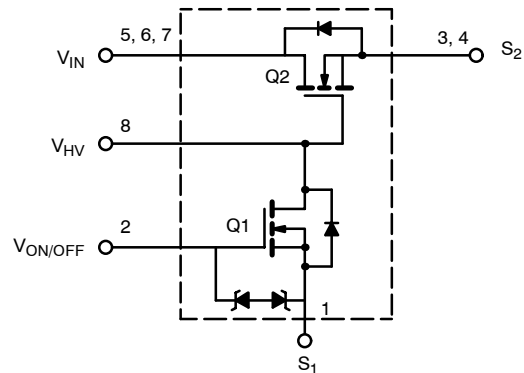

ABSOLUTE MAXIMUM RATINGS ( $T_A = 25^\circ\text{C}$ UNLESS OTHERWISE NOTED)				
Parameter	Symbol	Limit	Unit	
Input Voltage	$V_{IN}$	30	V	
Q2 Gate-Drive Voltage Referenced to S1 or S2	$V_{HV}$	20		
ON/OFF Voltage	$V_{ON/OFF}$	8		
Load Current	$I_L$	Continuous <sup>a</sup>	5.5	A
		Pulsed <sup>b</sup>	$\pm 20$	
Continuous Intrinsic Diode Conduction <sup>a</sup>	$I_S$	-1.15		
Maximum Power Dissipation <sup>a</sup>	$P_D$	1.25	W	
Operating Junction and Storage Temperature Range	$T_J, T_{stg}$	-55 to 150	$^\circ\text{C}$	
ESD Rating, MIL-STD-883D Human Body Model (100 pF, 1500 $\Omega$ )	ESD	3	kV	

THERMAL RESISTANCE RATINGS				
Parameter	Symbol	Typical	Maximum	Unit
Maximum Junction-to-Ambient (t = steady state) <sup>a</sup>	$R_{thJA}$	83	100	$^\circ\text{C/W}$
Maximum Junction-to-Foot (Q2)	$R_{thJC}$	25	30	

SPECIFICATIONS ( $T_J = 25^\circ\text{C}$ UNLESS OTHERWISE NOTED)						
Parameter	Symbol	Test Condition	Min	Typ	Max	Unit
<b>OFF Characteristics</b>						
Reverse Leakage Current	$I_{FL}$	$V_{IN} = 30$ V, $V_{ON/OFF} = 0$ V, $V_{HV} = 0$ V			1	$\mu\text{A}$
Diode Forward Voltage	$V_{SD}$	$I_S = -1.15$ A		0.7	1	V
<b>ON Characteristics</b>						
On-Resistance (Q2)	$r_{DS(on)}$	$V_{ON/OFF} = 0$ V, $I_D = 5.5$ A, $V_{HV} = 10$ V, $V_{S2} = 0$ V		0.019	0.024	$\Omega$
		$V_{ON/OFF} = 0$ V, $I_D = 4.5$ A, $V_{HV} = 4.5$ V, $V_{S2} = 0$ V		0.028	0.035	
On-State (Q2) Drain-Current	$I_{D(on)}$	$V_{IN} - V_{OUT} \leq 0.1$ V, $V_{IN} = 5$ V, $V_{ON/OFF} = 0$ V, $V_{HV} = 10$ V	15			A

Notes

- a. Surface Mounted on FR4 Board.
- b. Pulse test: pulse width  $\leq 300$   $\mu\text{s}$ , duty cycle  $\leq 2\%$ .



**TYPICAL CHARACTERISTICS (25°C UNLESS NOTED)**

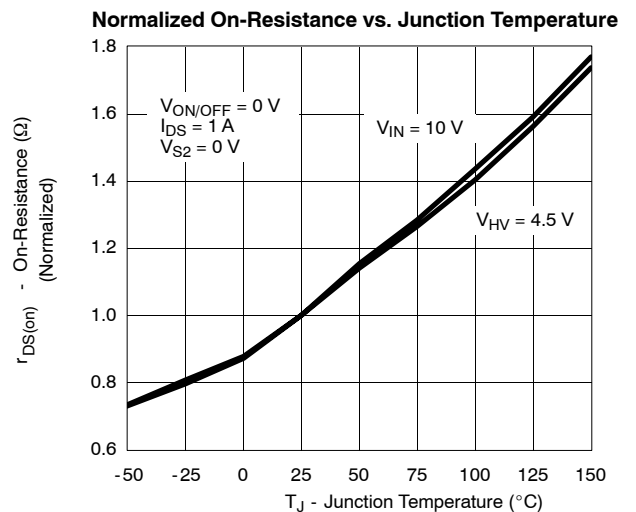
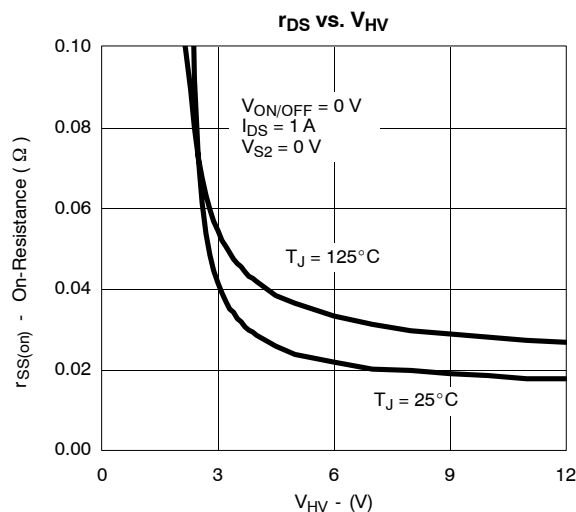
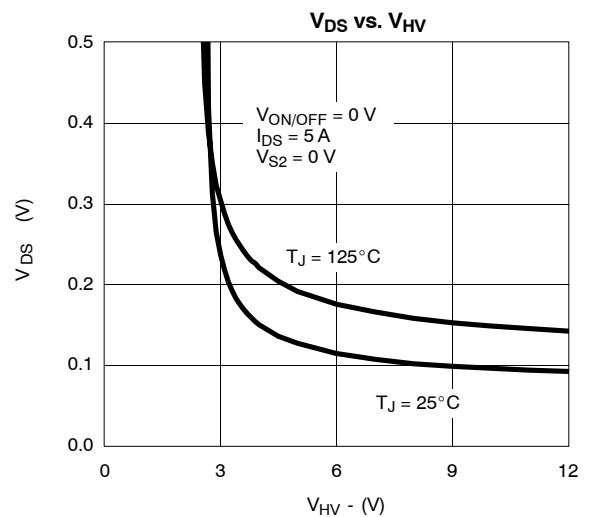
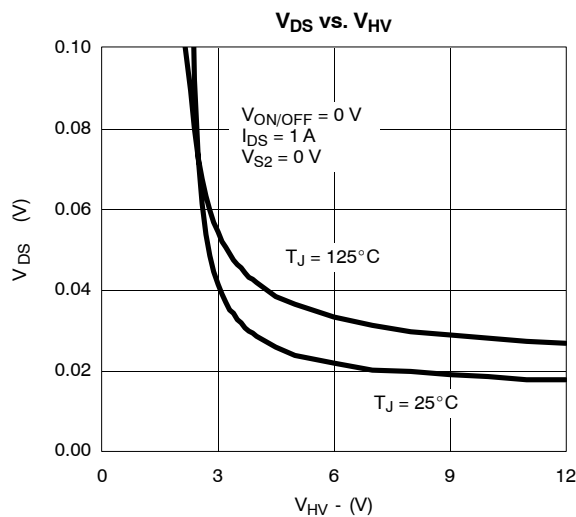
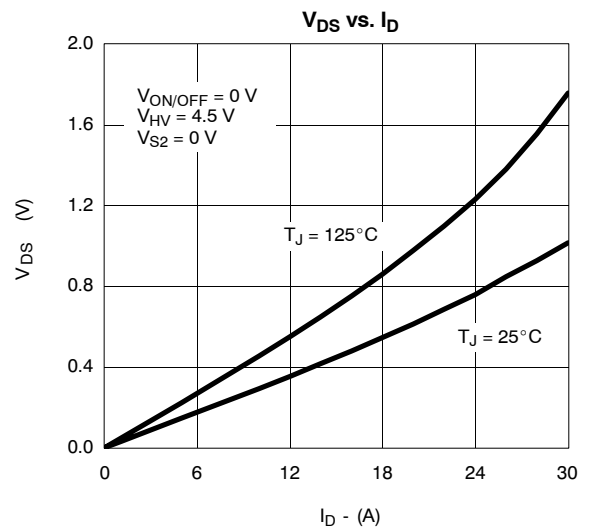
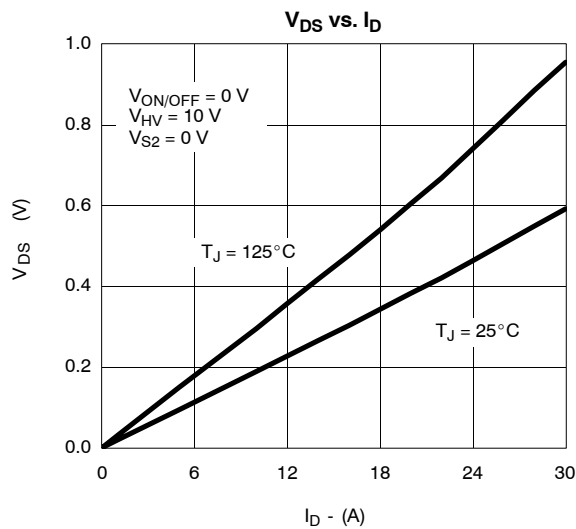



**TYPICAL CHARACTERISTICS (25°C UNLESS NOTED)**

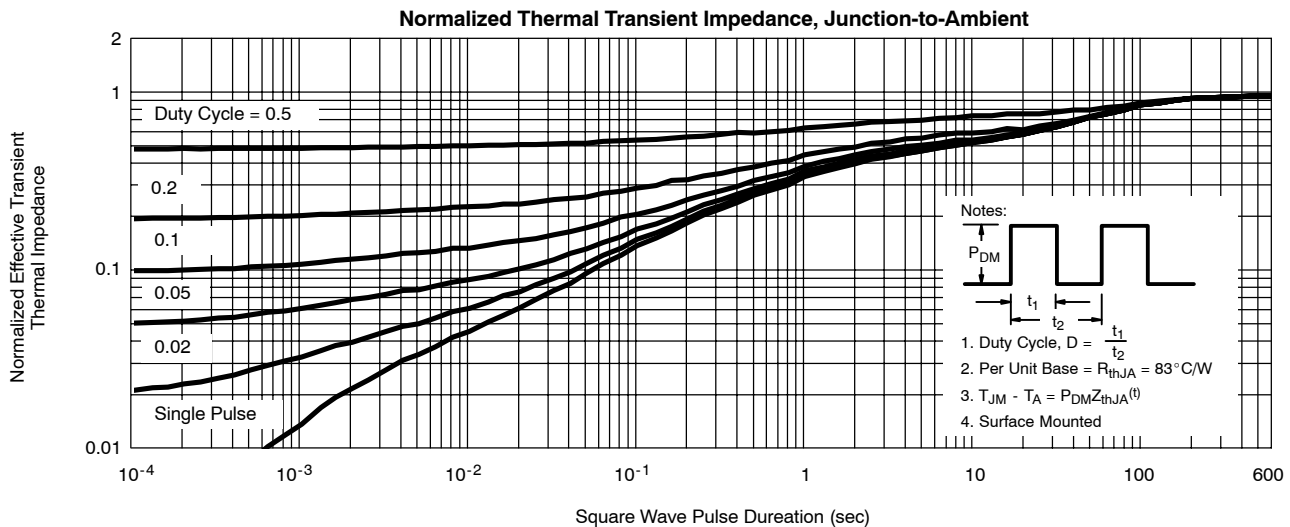
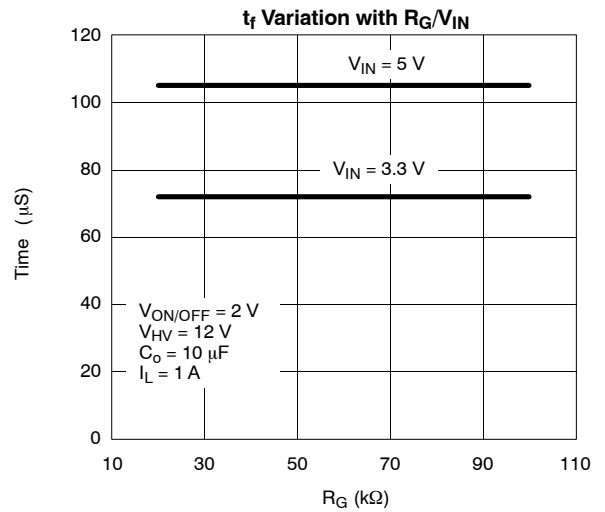
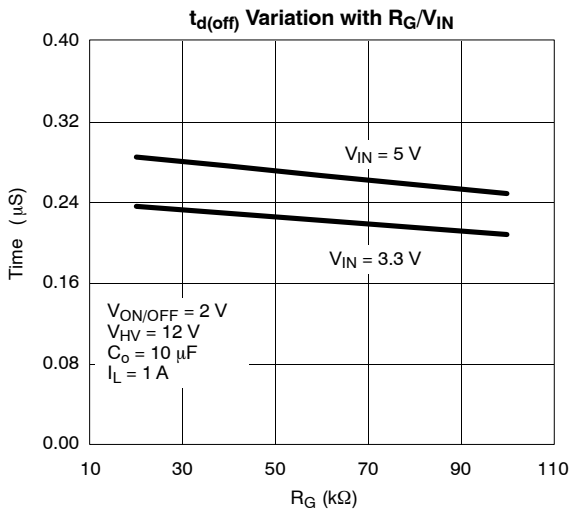
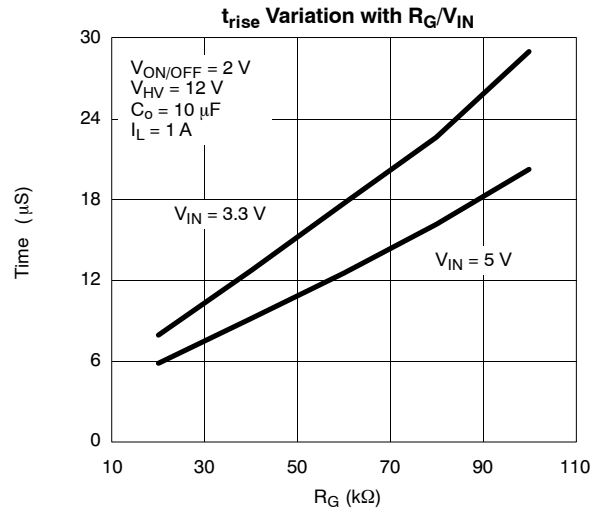
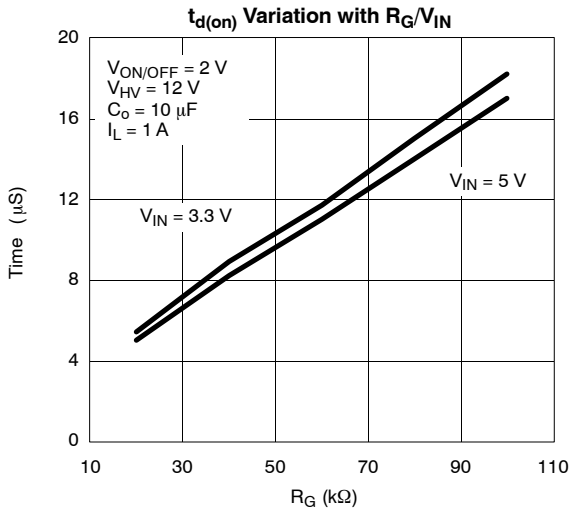

**TYPICAL CHARACTERISTICS (25 °C UNLESS NOTED)**

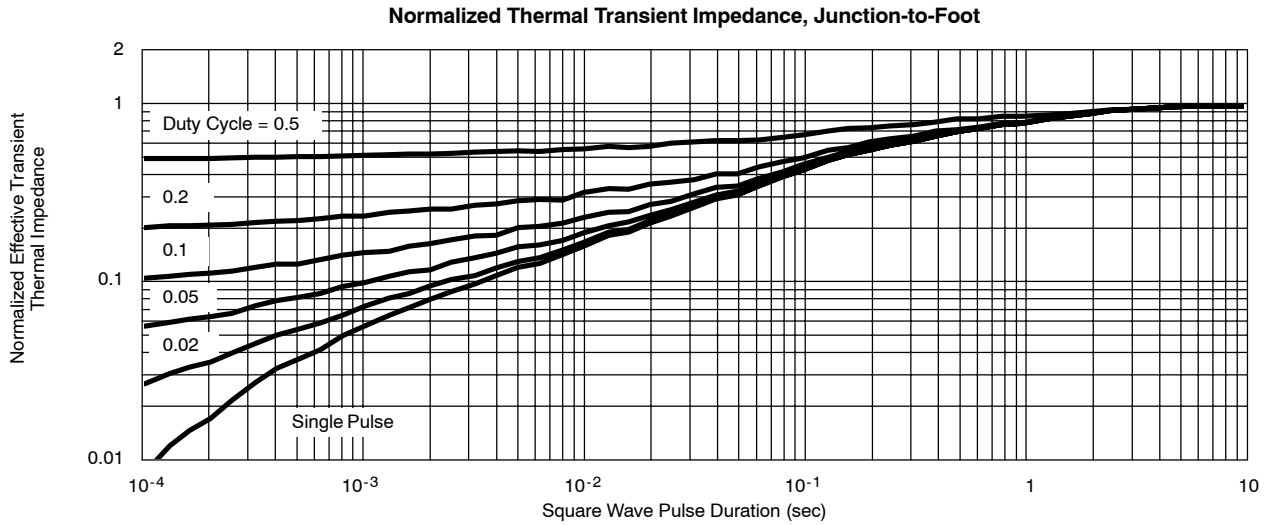

**TYPICAL APPLICATION CIRCUIT**

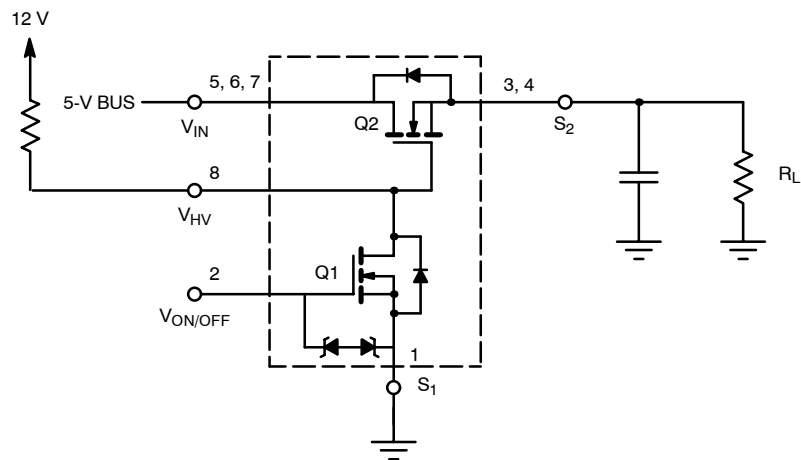

NOTE: Voltage difference between pull-up voltage, 12 V, and BUS voltage, 5 V, should be greater than 4.5 V.