

KSA473

PNP EPITAXIAL SILICON TRANSISTOR

T-33-17

**LOW FREQUENCY POWER AMPLIFIER
POWER REGULATOR**

- Complement to KSC1173
- Collector Current: $I_C = -3A$
- Collector Dissipation: $P_C = 10W$ ($T_C = 25^\circ C$)

ABSOLUTE MAXIMUM RATINGS ($T_a = 25^\circ C$)

Characteristic	Symbol	Rating	Unit
Collector-Base Voltage	V_{CBO}	-30	V
Collector-Emitter Voltage	V_{CEO}	-30	V
Emitter-Base Voltage	V_{EBO}	-5	V
Collector Current	I_C	-3	A
Collector Dissipation ($T_C = 25^\circ C$)	P_C	10	W
Junction Temperature	T_J	150	$^\circ C$
Storage Temperature	T_{stg}	-55 ~ +150	$^\circ C$

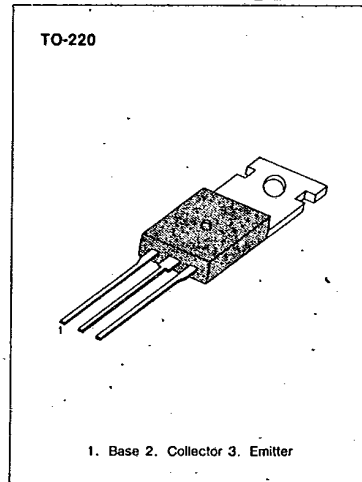

3

ELECTRICAL CHARACTERISTICS ($T_a = 25^\circ C$)

Characteristic	Symbol	Test Conditions	Min	Typ	Max	Unit
Collector-Base Breakdown Voltage	BV_{CBO}	$I_C = -500\mu A, I_E = 0$	-30			V
Collector-Emitter Breakdown Voltage	BV_{CEO}	$I_C = -10mA, I_B = 0$	-30			V
Emitter-Base Breakdown Voltage	BV_{EBO}	$I_E = 1mA, I_C = 0$	-5			V
Collector Cut-off Current	I_{CBO}	$V_{CB} = -20V, I_E = 0$			-1.0	μA
Emitter Cut-off Current	I_{EBO}	$V_{EB} = -5V, I_C = 0$			-1.0	μA
DC Current Gain	h_{FE1}	$V_{CE} = -2V, I_C = -0.5A$	70		240	
	h_{FE2}	$V_{CE} = -2V, I_C = -2.5A$	25			
Collector-Emitter Saturation Voltage	$V_{CE(sat)}$	$I_C = -2A, I_B = -0.2A$		-0.3	-0.8	V
Base-Emitter On Voltage	$V_{BE(on)}$	$V_{CE} = -2V, I_C = -0.5A$		-0.75	-1.0	V
Current Gain Bandwidth Product	f_T	$V_{CE} = -2V, I_C = -0.5A$		100		MHz
Output Capacitance	C_{ob}	$V_{CB} = -10V, I_E = 0, f = 1MHz$		40		PF

h_{FE} CLASSIFICATION

Classification	O	Y
$h_{FE}(1)$	70-140	120-240

KSA473

PNP EPITAXIAL SILICON TRANSISTOR

T-33-17

STATIC CHARACTERISTIC

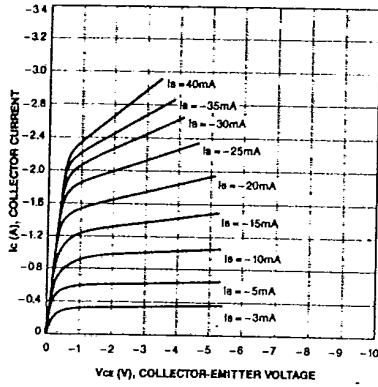

DC CURRENT GAIN

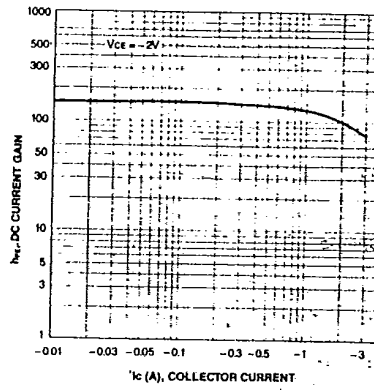

BASE-EMITTER SATURATION VOLTAGE
COLLECTOR-EMITTER SATURATION VOLTAGE

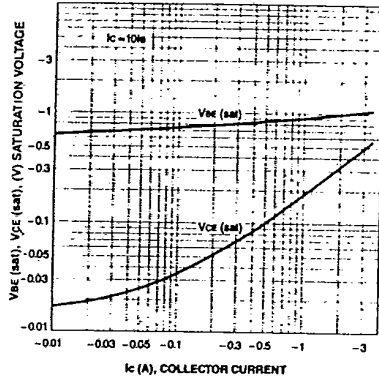

BASE-EMITTER ON VOLTAGE

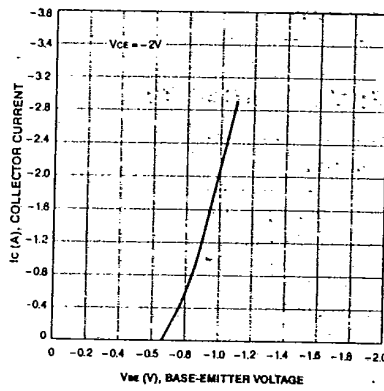

SAFE OPERATING AREA

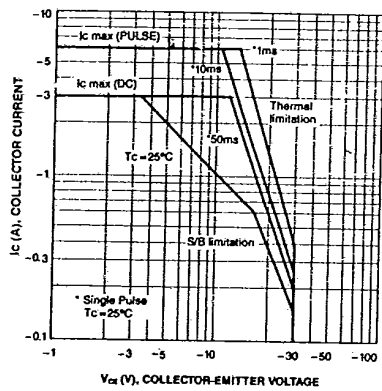

POWER DERTING

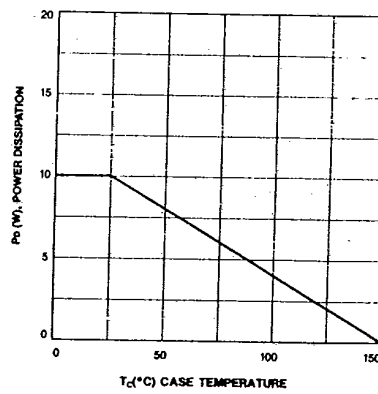

KSA473 PNP EPITAXIAL SILICON TRANSISTOR

T-33-17

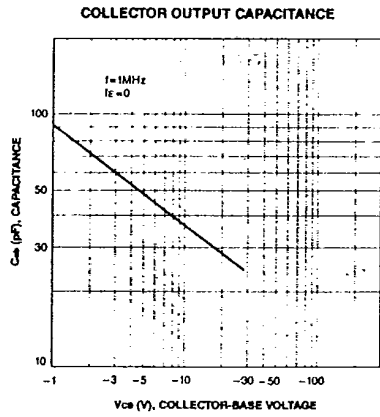

3



KSA614

PNP EPITAXIAL SILICON TRANSISTOR

T-33-19

**LOW FREQUENCY POWER AMPLIFIER
POWER REGULATOR**

- Complement to KSD288
- Collector-Base Voltage $V_{CB0} = -80V$
- Collector Dissipation $P_C = 25W$ ($T_C = 25^\circ C$)

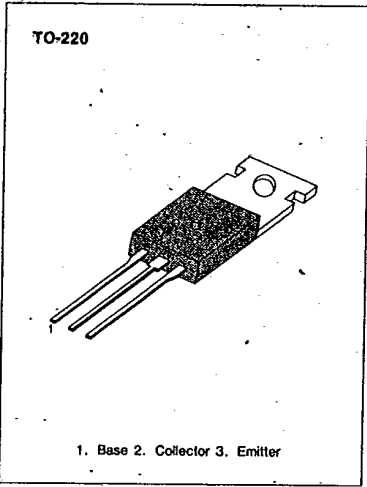

ABSOLUTE MAXIMUM RATINGS ($T_a = 25^\circ C$)

Characteristic	Symbol	Rating	Unit
Collector-Base Voltage	V_{CB0}	-80	V
Collector-Emitter Voltage	V_{CE0}	-55	V
Emitter-Base Voltage	V_{EB0}	-5	V
Collector Current	I_C	-3.0	A
Collector Dissipation ($T_C = 25^\circ C$)	P_C	25	W
Junction Temperature	T_j	150	$^\circ C$
Storage Temperature	T_{stg}	-55 ~ +150	$^\circ C$

ELECTRICAL CHARACTERISTICS ($T_a = 25^\circ C$)

Characteristic	Symbol	Test Conditions	Min	Typ	Max	Unit
Collector-Base Breakdown Voltage	BV_{CB0}	$I_C = -500\mu A, I_E = 0$	-80			V
Collector-Emitter Breakdown Voltage	BV_{CE0}	$I_C = -10mA, I_B = 0$	-55			V
Emitter-Base Breakdown Voltage	BV_{EB0}	$I_E = -500\mu A, I_C = 0$	-5			V
Collector Cut-off Current	I_{CB0}	$V_{CB} = -50V, I_E = 0$			50	μA
DC Current Gain	h_{FE}	$V_{CE} = -5V, I_C = -0.5A$	40		240	
Collector-Emitter Saturation Voltage	$V_{CE(sat)}$	$I_C = -1A, I_B = -0.1A$		-0.15	-0.5	V

h_{FE} CLASSIFICATION

Classification	R	O	Y
h_{FE}	40-80	70-140	120-240

KSA614

PNP EPITAXIAL SILICON TRANSISTOR

T-33-19

STATIC CHARACTERISTIC

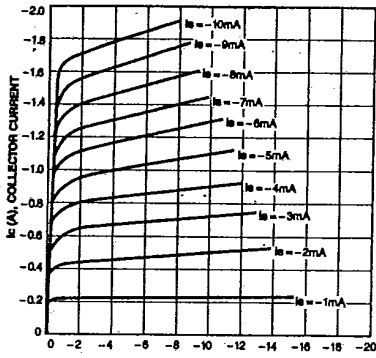

DC CURRENT GAIN

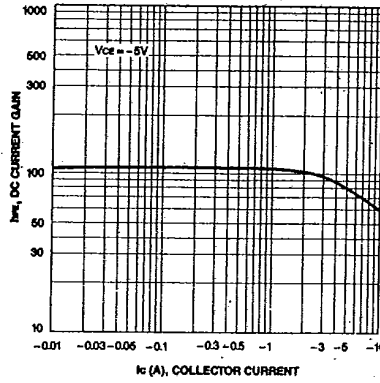

BASE-EMITTER SATURATION VOLTAGE
COLLECTOR-EMITTER SATURATION VOLTAGE

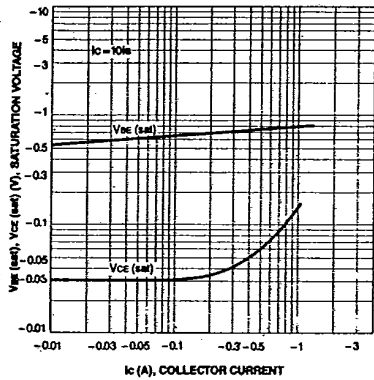

COLLECTOR OUTPUT CAPACITANCE

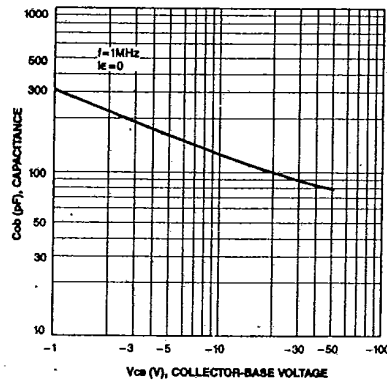

SAFE OPERATING AREA

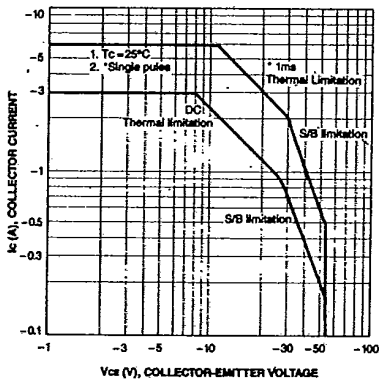

POWER DERATING

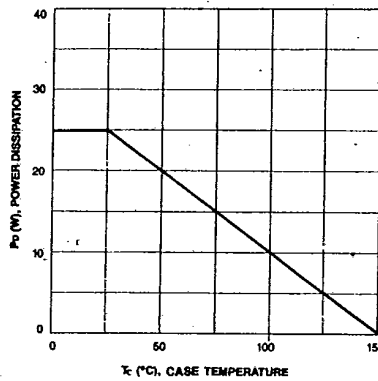

3

KSA634

PNP EPITAXIAL SILICON TRANSISTOR

T-33-17

**LOW FREQUENCY POWER AMPLIFIER
POWER REGULATOR**

- Complement to KSC1096
- Collector Current $I_C = -2A$
- Collector Dissipation $P_C = 10W$ ($T_C = 25^\circ C$)

ABSOLUTE MAXIMUM RATINGS ($T_a = 25^\circ C$)

Characteristic	Symbol	Rating	Unit
Collector-Base Voltage	V_{CBO}	-40	V
Collector-Emitter Voltage	V_{CEO}	-30	V
Emitter-Base Voltage	V_{EBO}	-5	V
Collector Current	I_C	-2.0	A
Collector Dissipation ($T_C = 25^\circ C$)	P_C	10	W
Junction Temperature	T_J	150	$^\circ C$
Storage Temperature	T_{stg}	-55 ~ +150	$^\circ C$

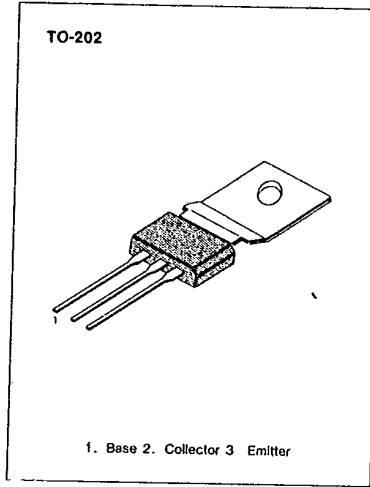

ELECTRICAL CHARACTERISTICS ($T_a = 25^\circ C$)

Characteristic	Symbol	Test Conditions	Min	Typ	Max	Unit
Collector-Base Breakdown Voltage	BV_{CBO}	$I_C = -500\mu A, I_E = 0$	-40			V
Collector-Emitter Breakdown Voltage	BV_{CEO}	$I_C = -10mA, I_B = 0$	-30			V
Emitter-Base Breakdown Voltage	BV_{EBO}	$I_E = -500\mu A, I_C = 0$	-5			V
Collector Cut-off Current	I_{CBO}	$V_{CB} = -30V, I_E = 0$			-1	μA
DC Current Gain	h_{FE}	$V_{CE} = -5V, I_C = -1.0A$	40		240	
Collector-Emitter Saturation Voltage	$V_{CE(sat)}$	$I_C = -1.5A, I_B = -0.15A$		-0.3	-0.7	V

h_{FE} CLASSIFICATION

Classification	R	O	Y
h_{FE}	40-80	70-140	120-240

KSA634

PNP EPITAXIAL SILICON TRANSISTOR

T-33-17

STATIC CHARACTERISTIC

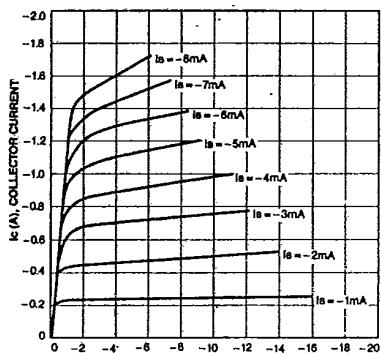

DC CURRENT GAIN

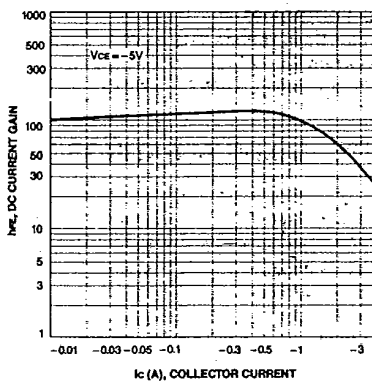

BASE-EMITTER SATURATION VOLTAGE
COLLECTOR-EMITTER SATURATION VOLTAGE

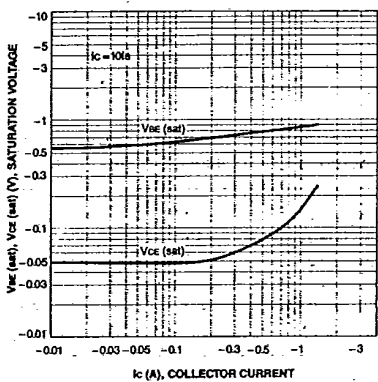

COLLECTOR OUTPUT CAPACITANCE

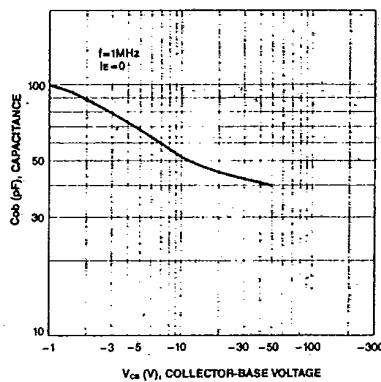

SAFE OPERATING AREA

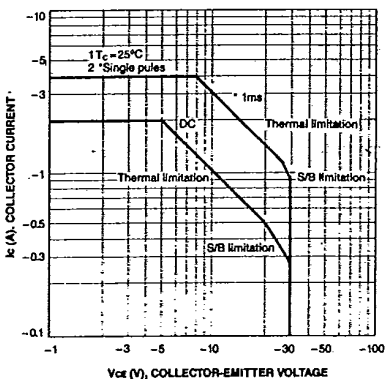

POWER DERATING

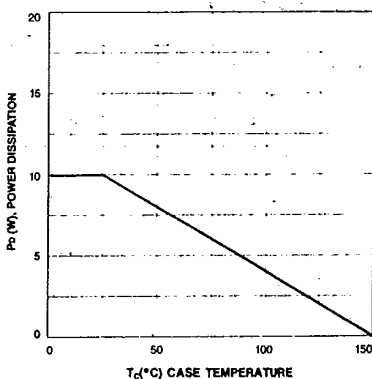

3

