

FEATURES

- **CTR Minimum at $I_F = 1$ mA**
H11B1, 500%
H11B2, 200%
H11B3, 100%
- **Isolation Test Voltage, 5300 VAC_{RMS}**
- **Coupling Capacitance, 0.5 pF**
- **Underwriters Lab File #E52744**
- **VDE Approval #0884 (Available with Option 1)**

DESCRIPTION

The H11B1/H11B2/H11B3 are industry standard optocouplers, consisting of a Gallium Arsenide infrared LED and a silicon photodarlington. These optocouplers are constructed with a high voltage insulation, double molded packaging process which offers 7.5 KV withstand test capability.

Maximum Ratings

Emitter

Reverse Voltage 3 V
 Continuous Forward Current 60 mA
 Power Dissipation at 25°C 100 mW
 Derate Linearly from 25°C 1.33 mW/°C

Detector

Collector-Emitter Breakdown Voltage, BV_{CEO} 25 V
 Emitter-Collector Breakdown Voltage BV_{ECO} 7 V
 Collector-Base Breakdown Voltage, BV_{CBO} 30 V
 Collector-Current (Continuous) 100 mA
 Power Dissipation at 25°C 150 mW
 Derate Linearly from 25°C 2.0 mW/°C

Package

Isolation Test Voltage (between emitter and detector refer to standard climate 23°C/50%RH, DIN 50014) 5300 VAC_{RMS}
 Creepage min. 7 mm
 Clearance min. 7 mm
 Comparative Tracking Index per DIN IEC 112/VDE 0303, part 1 175
 Isolation Resistance
 $V_{IO}=500$ V, $T_A=25^\circ\text{C}$ $\geq 10^{12}$ Ω
 $V_{IO}=500$ V, $T_A=100^\circ\text{C}$ $\geq 10^{11}$ Ω
 Total Package Dissipation at 25°C (LED plus Detector) 260 mW
 Derate Linearly from 25°C 3.5 mW/°C
 Storage Temperature -55°C to +150°C
 Operating Temperature -55°C to +100°C
 Lead Soldering Time at 260°C 10 sec.

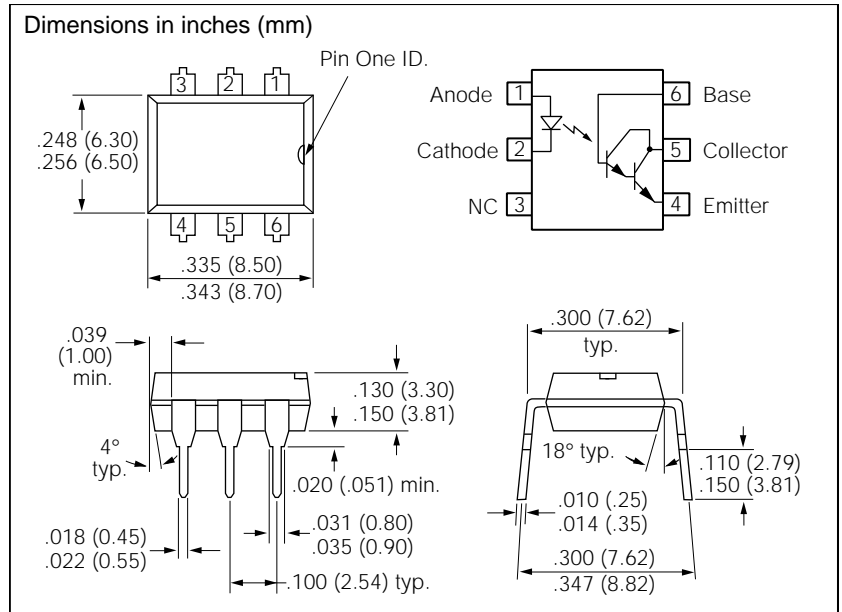

Characteristics ($T_A=25^\circ\text{C}$)

	Sym	Min.	Typ.	Max.	Unit	Condition
Emitter						
Forward Voltage H11B1, B2 H11B3	V_F V_F		1.1 1.1	1.5 1.5	V V	$I_F=10$ mA $I_F=50$ mA
Reverse Current	I_R			10	μA	$V_R=3$ V
Junction Capacitance	C_J		50		pF	$V_F=0$ V, $f=1$ MHz
Detector						
BV_{CEO}		30			V	$I_C=1.0$ mA, $I_F=0$ mA
BV_{ECO}		7			V	$I_E=100$ μA , $I_F=0$ mA
BV_{CBO}		30			V	$I_C=100$ μA , $I_F=0$ mA
I_{CEO}				100	nA	$V_{CE}=10$ V, $I_F=0$ mA
Package						
V_{CEsat}				1.0		$I_C=1$ mA, $I_C=1$ mA
DC Current Transfer Ratio H11B1 H11B2 H11B3	CTR CTR CTR	500 200 100			% % %	$V_{CE}=5$ V, $I_F=1$ mA $V_{CE}=5$ V, $I_F=1$ mA $V_{CE}=5$ V, $I_F=1$ mA
Capacitance Input to Output	C_{IO}		0.5		pF	
Switching Times	t_{on} t_{off}		5 30		μs μs	$I_F=5$ mA $V_{CE}=10$ V $R_L=100$ Ω

Figure 1. Forward voltage versus forward current

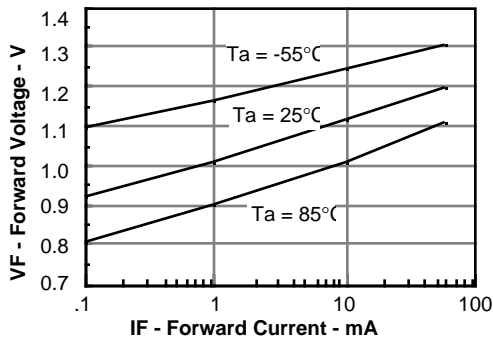

Figure 2. Normalized non-saturated and saturated CTR_{ce} versus LED current

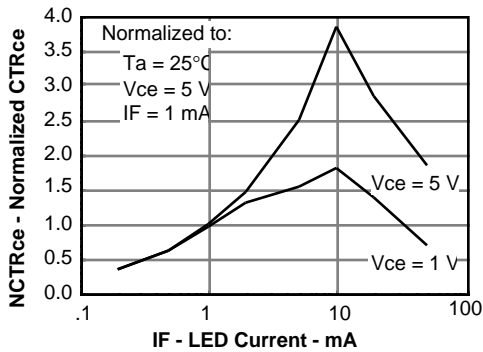

Figure 3. Normalized non-saturated and saturated I_{ce} versus LED current

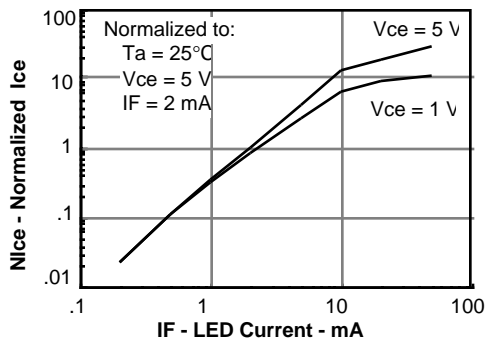

Figure 4. Normalized non-saturated and saturated collector-emitter current versus LED current

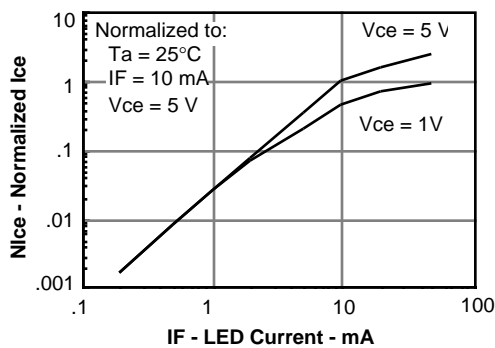

Figure 5. Non-saturated and saturated HFE versus base current

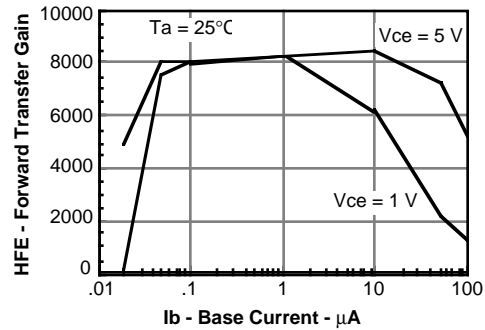

Figure 6. Low to high propagation delay versus collector load resistance and LED current

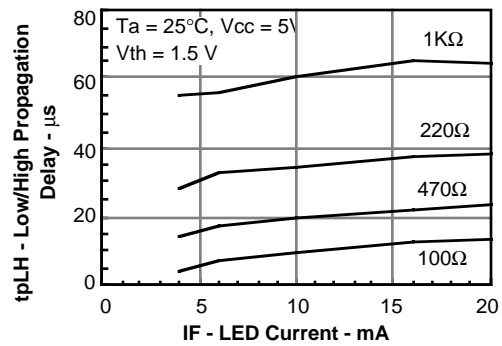

Figure 7. High to low propagation delay versus collector load resistance and LED current

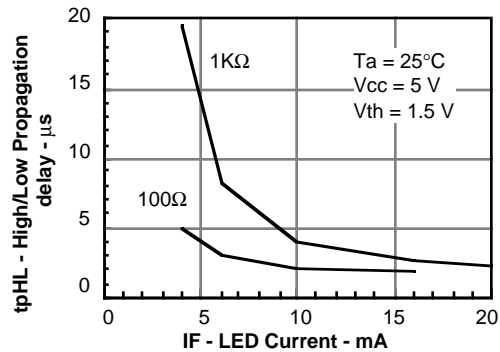

Figure 8. Switching waveform and schematic

