

MBRS260T3

Surface Mount Schottky Power Rectifier

SMB Power Surface Mount Package

... employing the Schottky Barrier principle in a metal-to-silicon power rectifier. Features epitaxial construction with oxide passivation and metal overlay contact. Ideally suited for low voltage, high frequency switching power supplies; free wheeling diodes and polarity protection diodes.

- Compact Package with J-Bend Leads Ideal for Automated Handling
- Highly Stable Oxide Passivated Junction
- Guardring for Over-Voltage Protection
- Low Forward Voltage Drop

Mechanical Characteristics:

- Case: Molded Epoxy
- Epoxy Meets UL94, VO at 1/8"
- Weight: 95 mg (approximately)
- Cathode Polarity Band
- Lead and Mounting Surface Temperature for Soldering Purposes: 260°C Max. for 10 Seconds
- Available in 12 mm Tape, 2500 Units per 13" Reel, Add "T3" Suffix to Part Number
- Finish: All External Surfaces Corrosion Resistant and Terminal Leads are Readily Solderable
- ESD Ratings: Machine Model = C
Human Body Model = 3B
- Marking: B26

MAXIMUM RATINGS

| Rating | Symbol | Value | Unit |
|---|---------------------------------|-------------|------------------------|
| Peak Repetitive Reverse Voltage Working Peak Reverse Voltage DC Blocking Voltage | V_{RRM} V_{RWM} V_R | 60 | V |
| Average Rectified Forward Current (At Rated V_R , $T_L = 95^\circ\text{C}$) | I_O | 2.0 | A |
| Non-Repetitive Peak Surge Current (Surge Applied at Rated Load Conditions Halfwave, Single Phase, 60 Hz) | I_{FSM} | 60 | A |
| Storage/Operating Case Temperature | T_{stg} , T_C | -55 to +150 | $^\circ\text{C}$ |
| Operating Junction Temperature | T_J | -55 to +125 | $^\circ\text{C}$ |
| Voltage Rate of Change (Rated V_R , $T_J = 25^\circ\text{C}$) | dv/dt | 10,000 | $\text{V}/\mu\text{s}$ |



ON Semiconductor®

<http://onsemi.com>

**SCHOTTKY BARRIER
RECTIFIER
2.0 AMPERES
60 VOLTS**



**SMB
CASE 403A
PLASTIC**

MARKING DIAGRAM

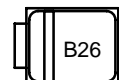

B26 = Device Code

ORDERING INFORMATION

| Device | Package | Shipping |
|-----------|---------|------------------|
| MBRS260T3 | SMB | 2500/Tape & Reel |

MBRS260T3

THERMAL CHARACTERISTICS

| Characteristic | Symbol | Value | Unit |
|---|-----------------|-------|-----------------------------|
| Thermal Resistance - Junction-to-Lead (Note 1) | $R_{\theta JL}$ | 24 | $^{\circ}\text{C}/\text{W}$ |
| Thermal Resistance - Junction-to-Ambient (Note 2) | $R_{\theta JA}$ | 80 | $^{\circ}\text{C}/\text{W}$ |

ELECTRICAL CHARACTERISTICS

| | | | | |
|--|-------|----------------------------|-----------------------------|-------|
| Maximum Instantaneous Forward Voltage (Note 3) ($i_F = 1.0 \text{ A}$) ($i_F = 2.0 \text{ A}$) | V_F | $T_J = 25^{\circ}\text{C}$ | $T_J = 125^{\circ}\text{C}$ | Volts |
| | | 0.51 0.63 | 0.475 0.55 | |
| Maximum Instantaneous Reverse Current (Note 3) ($V_R = 60 \text{ V}$) | I_R | $T_J = 25^{\circ}\text{C}$ | $T_J = 125^{\circ}\text{C}$ | mA |
| | | 0.2 | 10 | |

1. Mounted with minimum recommended pad size, PC Board FR4.
2. 1 inch square pad size (1 x 0.5 inch for each lead) on FR4 board.
3. Pulse Test: Pulse Width $\leq 250 \mu\text{s}$, Duty Cycle $\leq 2.0\%$.

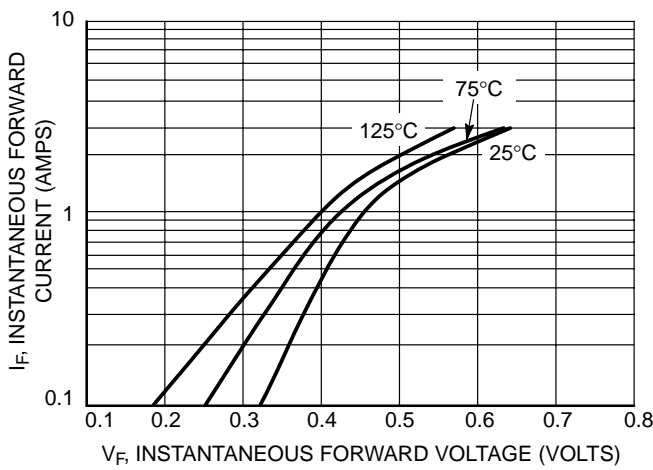

Figure 1. Typical Forward Voltage

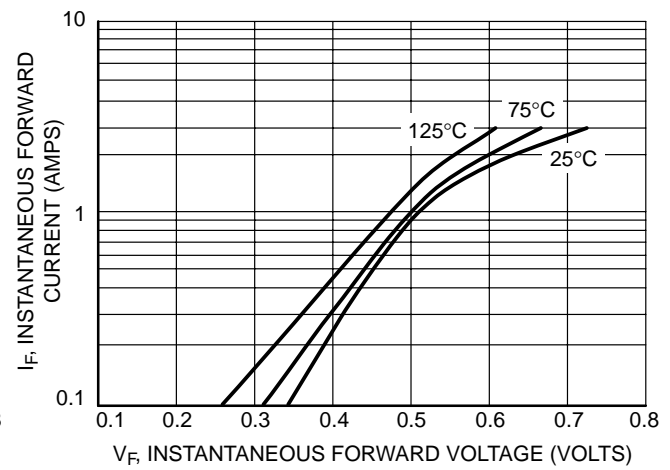

Figure 2. Maximum Forward Voltage

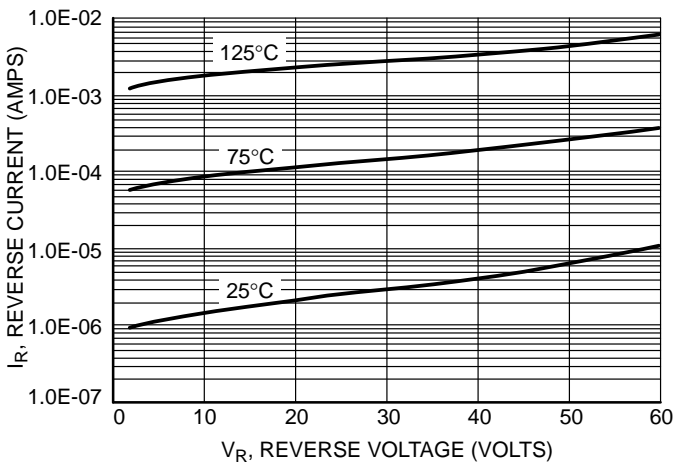

Figure 3. Typical Reverse Current

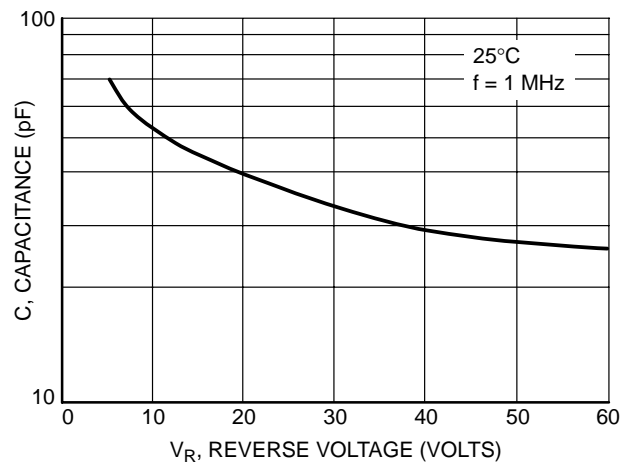

Figure 4. Typical Capacitance

MBRS260T3

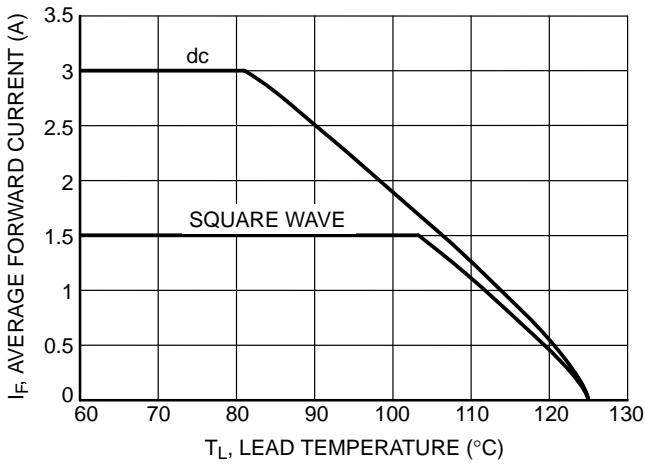

Figure 5. Current Derating - Junction to Lead

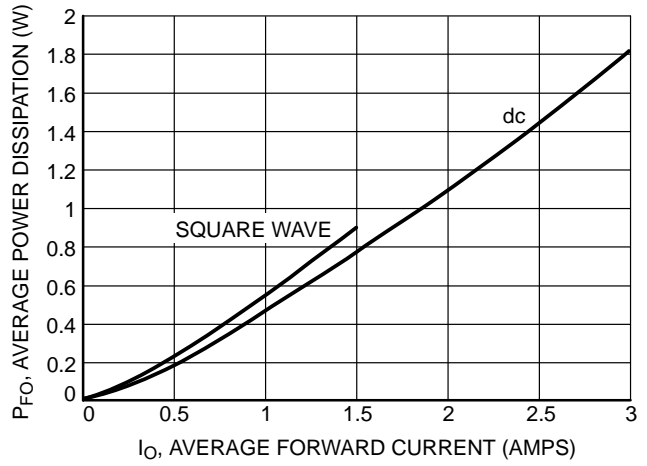

Figure 6. Forward Power Dissipation

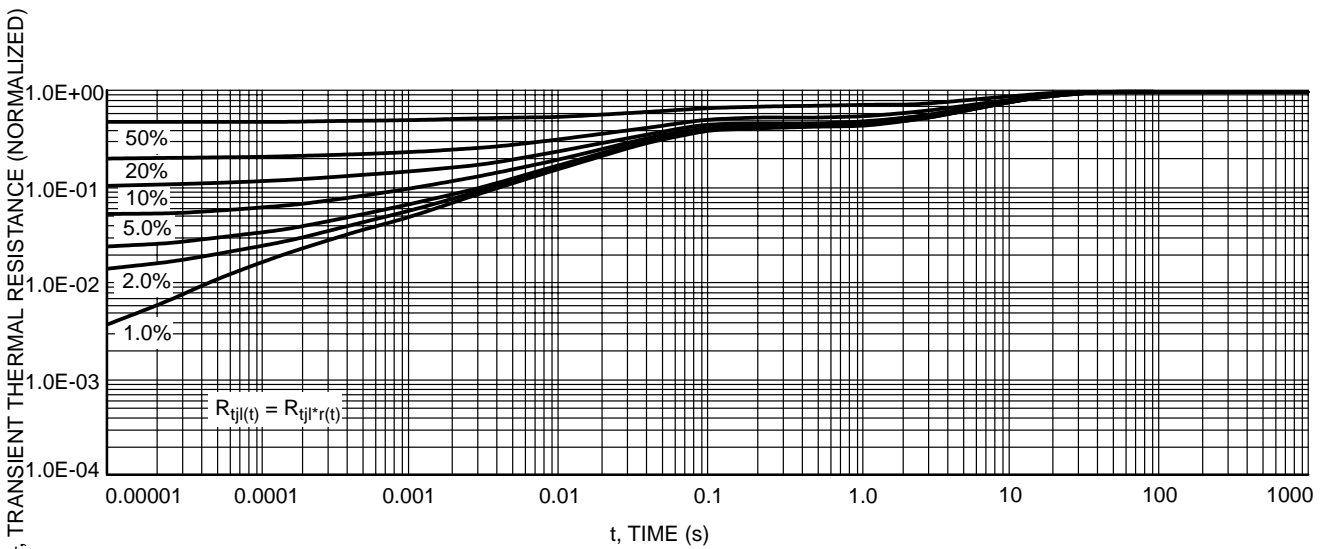

Figure 7. Thermal Response - Junction to Case

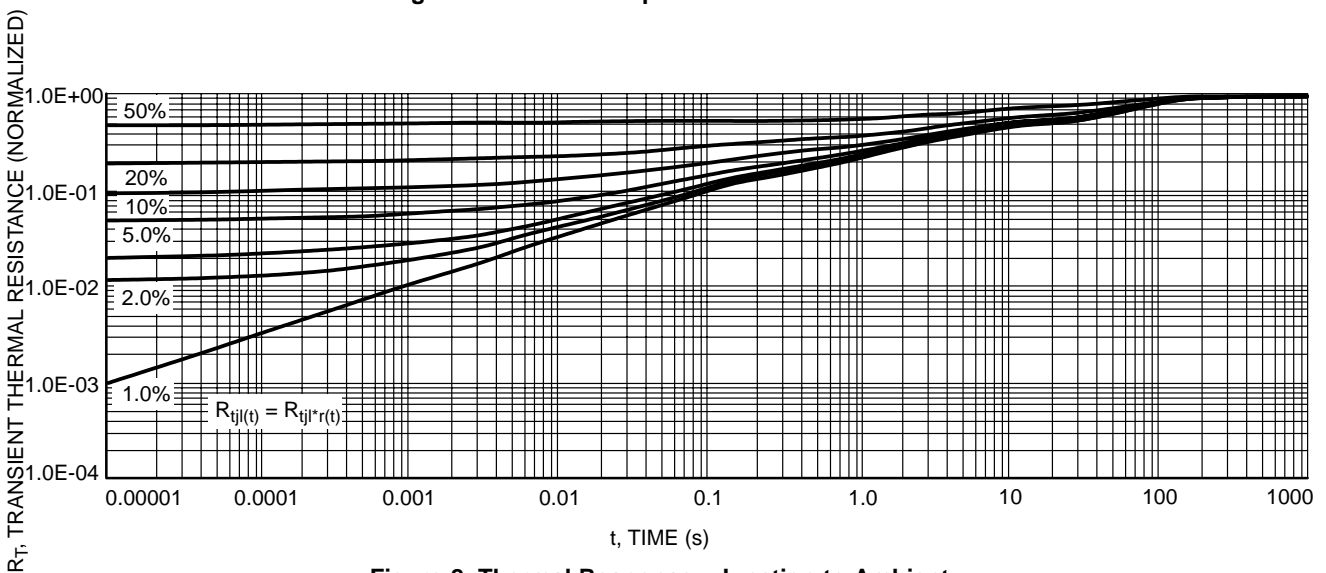
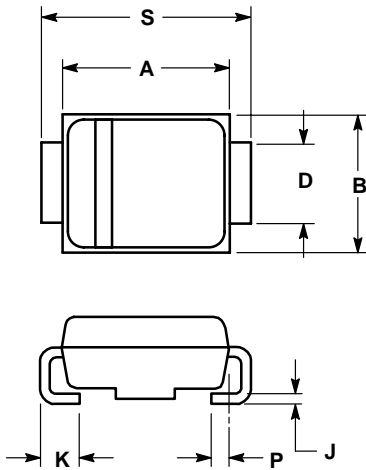

Figure 8. Thermal Response - Junction to Ambient

MBRS260T3

PACKAGE DIMENSIONS

SMB
PLASTIC PACKAGE
CASE 403A-03
ISSUE D



- NOTES:
1. DIMENSIONING AND TOLERANCING PER ANSI Y14.5M, 1982.
 2. CONTROLLING DIMENSION: INCH.
 3. D DIMENSION SHALL BE MEASURED WITHIN DIMENSION P.

| DIM | INCHES | | MILLIMETERS | |
|-----|-----------|--------|-------------|-------|
| | MIN | MAX | MIN | MAX |
| A | 0.160 | 0.180 | 4.06 | 4.57 |
| B | 0.130 | 0.150 | 3.30 | 3.81 |
| C | 0.075 | 0.095 | 1.90 | 2.41 |
| D | 0.077 | 0.083 | 1.96 | 2.11 |
| H | 0.0020 | 0.0060 | 0.051 | 0.152 |
| J | 0.006 | 0.012 | 0.15 | 0.30 |
| K | 0.030 | 0.050 | 0.76 | 1.27 |
| P | 0.020 REF | | 0.51 REF | |
| S | 0.205 | 0.220 | 5.21 | 5.59 |

MINIMUM SOLDER PAD SIZES

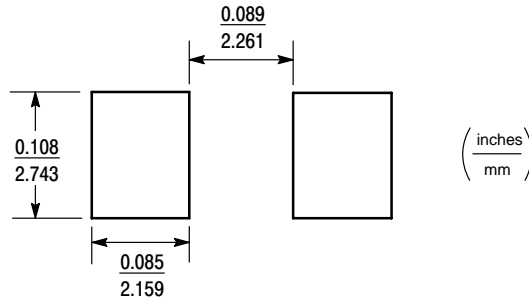

ON Semiconductor and  are registered trademarks of Semiconductor Components Industries, LLC (SCILLC). SCILLC reserves the right to make changes without further notice to any products herein. SCILLC makes no warranty, representation or guarantee regarding the suitability of its products for any particular purpose, nor does SCILLC assume any liability arising out of the application or use of any product or circuit, and specifically disclaims any and all liability, including without limitation special, consequential or incidental damages. "Typical" parameters which may be provided in SCILLC data sheets and/or specifications can and do vary in different applications and actual performance may vary over time. All operating parameters, including "Typicals" must be validated for each customer application by customer's technical experts. SCILLC does not convey any license under its patent rights nor the rights of others. SCILLC products are not designed, intended, or authorized for use as components in systems intended for surgical implant into the body, or other applications intended to support or sustain life, or for any other application in which the failure of the SCILLC product could create a situation where personal injury or death may occur. Should Buyer purchase or use SCILLC products for any such unintended or unauthorized application, Buyer shall indemnify and hold SCILLC and its officers, employees, subsidiaries, affiliates, and distributors harmless against all claims, costs, damages, and expenses, and reasonable attorney fees arising out of, directly or indirectly, any claim of personal injury or death associated with such unintended or unauthorized use, even if such claim alleges that SCILLC was negligent regarding the design or manufacture of the part. SCILLC is an Equal Opportunity/Affirmative Action Employer.

PUBLICATION ORDERING INFORMATION

Literature Fulfillment:
 Literature Distribution Center for ON Semiconductor
 P.O. Box 5163, Denver, Colorado 80217 USA
Phone: 303-675-2175 or 800-344-3860 Toll Free USA/Canada
Fax: 303-675-2176 or 800-344-3867 Toll Free USA/Canada
Email: ONlit@hibbertco.com

N. American Technical Support: 800-282-9855 Toll Free USA/Canada

JAPAN: ON Semiconductor, Japan Customer Focus Center
 2-9-1 Kamimeguro, Meguro-ku, Tokyo, Japan 153-0051
Phone: 81-3-5773-3850
Email: r14525@onsemi.com

ON Semiconductor Website: <http://onsemi.com>

For additional information, please contact your local Sales Representative.