



CYPRESS

PRELIMINARY

CY2280

100-MHz Pentium® II Clock Synthesizer/Driver with Spread Spectrum for Mobile or Desktop PCs

Features

- Mixed 2.5V and 3.3V operation
- Clock solution for Pentium® II, and other similar processor-based motherboards
 - Four 2.5V CPU clocks up to 100 MHz
 - Eight 3.3V synch. PCI clocks, one free-running
 - Two 3.3V 48-MHz USB clocks
 - Three 3.3V Ref. clocks at 14.318 MHz
 - Two 2.5V APIC clocks at 14.318 MHz or PCI/2
- EMI control
 - Spread spectrum clocking
 - Factory-EPROM programmable spread spectrum margin
 - Factory-EPROM programmable output drive and slew rate
- Factory-EPROM programmable CPU clock frequencies for custom configurations
- Available in space-saving 48-pin SSOP package

Functional Description

The CY2280 is a Spread Spectrum clock synthesizer/driver for a Pentium II, or other similar processor-based PC requiring 100-MHz support. All of the required system clocks are provided in a space saving 48-pin SSOP package. The CY2280 can be used with the CY231x for a total solution for systems with SDRAM.

The CY2280 provides the option of spread spectrum clocking on the CPU and PCI clocks for reduced EMI. A downspread percentage is introduced when the SEL_SS input is asserted. The device can be run without spread spectrum when the SEL_SS input is deasserted. The percentage of spreading is EPROM-programmable to optimize EMI-reduction.

The CY2280 has power-down, CPU stop, and PCI stop pins for power management control. The signals are synchronized on-chip, and ensure glitch-free transitions on the outputs. When the CPU_STOP input is asserted, the CPU clock outputs are driven LOW. When the PCI_STOP input is asserted, the PCI clock outputs (except the free-running PCI clock) are driven LOW. When the PWR_DWN pin is asserted, the reference oscillator and PLLs are shut down, and all outputs are driven LOW.

CY2280 Selector Guide

Clock Outputs	CY2280 Configuration Options					
	-1	-11S	-12S	-13S	-21S	-31S
CPU (66.6, 100 MHz)	4	4	4	4	4	4
PCI (CPU/2, CPU/3)	8	8	8	8	8	8
USB (48 MHz)	2	2	2	2	2	2
APIC (14.318 MHz)	2	2	2	2	--	2
APIC (PCI/2)	--	--	--	--	2	--
Reference (14.318 MHz)	3	3	3	3	3	3
CPU-PCI delay	1.5–4.0 ns	1.5–4.0 ns	1.5–4.0 ns	1.5–4.0 ns	1.5–4.0 ns	0 ns
CPU-APIC delay	--	--	--	--	2.0–4.5 ns	--
Spread Spectrum (Downspread)	N/A	-0.6%	-1.0%	-1.5%	-0.6%	-0.6%

Logic Block Diagram

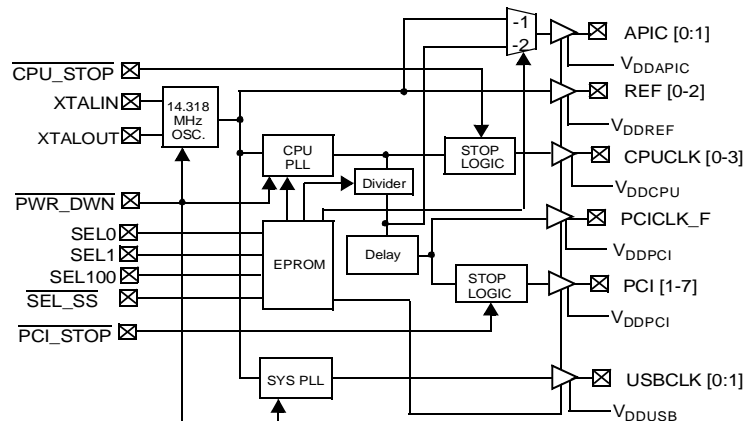

Pentium is a registered trademark of Intel Corporation.

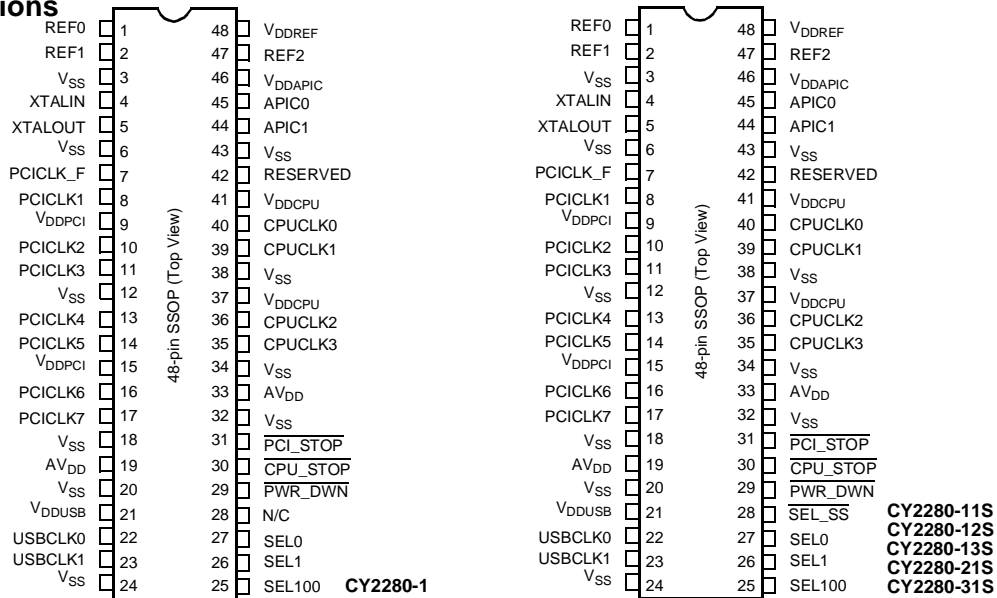
Pin Configurations

Pin Summary

Name	Pins	Description
VDDPCI	15, 9	3.3V Digital voltage supply for PCI clocks
VDDUSB	21	3.3V Digital voltage supply for USB clocks
VDDREF	48	3.3V Digital voltage supply for REF clocks
VDDAPIC	46	2.5V Digital voltage supply for APIC clocks
VDDCPU	41, 37	2.5V Digital voltage supply for CPU clocks
AVDD	33, 19	Analog voltage supply, 3.3V
VSS	3, 6, 12, 18, 20, 24, 32, 34, 38, 43	Ground
XTALIN ^[1]	4	Reference crystal input
XTALOUT ^[1]	5	Reference crystal feedback
PCI_STOP	31	Active LOW control input to stop PCI clocks
CPU_STOP	30	Active LOW control input to stop CPU clocks
PWR_DWN	29	Active LOW control input to power down device
SEL_SS	28	Spread spectrum select input (-11S, -12S, -13S, -21S, -31S options)
N/C	28	Spread spectrum select input (-1 option)
SEL0	27	CPU frequency select input, bit 0 (see Function Table)
SEL1	26	CPU frequency select input, bit 1 (see Function Table)
SEL100	25	CPU frequency select input, selects between 100 MHz and 66.6 MHz (see Function Table)
CPUCLK[0:3]	40, 39, 36, 35	CPU clock outputs
PCICLK[1:7]	8, 10, 11, 13, 14, 16, 17	PCI clock outputs, at one-half or one-third the CPU frequency of 66.6 MHz or 100 MHz respectively
PCICLK_F	7	Free-running PCI clock output
APIC[0:1]	45, 44	APIC clock outputs
REF[0:2]	1, 2, 47	3.3V Reference clock outputs
USBCLK[0:1]	22, 23	USB clock outputs
RESERVED	42	Reserved

Note:

- For best accuracy, use a parallel-resonant crystal, C_{LOAD} = 18 pF.

Function Table (-11S, -12S, -13S, -31S Options)

SEL100	SEL1	SEL0	$\overline{\text{SEL_SS}}^{[2]}$	CPU/PCI Ratio	CPUCLK	PCICLK_F PCICLK	REF	APIC	USBCLK
0	0	0	N/A	2	Hi-Z	Hi-Z	Hi-Z	Hi-Z	Hi-Z
0	0	1	N/A	2	Reserved	Reserved	14.318 MHz	14.318 MHz	48 MHz
0	1	0	N/A	2	Reserved	Reserved	14.318 MHz	14.318 MHz	48 MHz
0	1	1	0 (downspread)	2	66.66 MHz	33.33 MHz	14.318 MHz	14.318 MHz	48 MHz
0	1	1	1 (no spread)	2	66.66 MHz	33.33 MHz	14.318 MHz	14.318 MHz	48 MHz
1	0	0	N/A	3	TCLK/2	TCLK/6	TCLK ^[3]	TCLK ^[3]	TCLK/2
1	0	1	N/A	3	Reserved	Reserved	14.318 MHz	14.318 MHz	48 MHz
1	1	0	N/A	3	Reserved	Reserved	14.318 MHz	14.318 MHz	48 MHz
1	1	1	0 (downspread)	3	100 MHz	33.33 MHz	14.318 MHz	14.318 MHz	48 MHz

Function Table (-21S Option)

SEL100	SEL1	SEL0	$\overline{\text{SEL_SS}}^{[2]}$	CPU/PCI Ratio	CPUCLK	PCICLK_F PCICLK	REF	APIC	USBCLK
0	0	0	N/A	2	Hi-Z	Hi-Z	Hi-Z	Hi-Z	Hi-Z
0	0	1	N/A	2	Reserved	Reserved	14.318 MHz	Reserved	48 MHz
0	1	0	N/A	2	Reserved	Reserved	14.318 MHz	Reserved	48 MHz
0	1	1	0 (downspread)	2	66.66 MHz	33.33 MHz	14.318 MHz	16.67 MHz	48 MHz
0	1	1	1 (no spread)	2	66.66 MHz	33.33 MHz	14.318 MHz	16.67 MHz	48 MHz
1	0	0	N/A	3	TCLK/2	TCLK/6	TCLK ^[3]	TCLK/12 ^[3]	TCLK/2
1	0	1	N/A	3	Reserved	Reserved	14.318 MHz	Reserved	48 MHz
1	1	0	N/A	3	Reserved	Reserved	14.318 MHz	Reserved	48 MHz
1	1	1	0 (downspread)	3	100 MHz	33.33 MHz	14.318 MHz	16.67 MHz	48 MHz

Actual Clock Frequency Values

Clock Output	Target Frequency (MHz)	Actual Frequency (MHz)	PPM
CPUCLK	66.67	66.654	-195
CPUCLK	100	99.77	-2346
USBCLK	48.0	48.008	167

Power Management Logic

$\overline{\text{CPU_STOP}}$	$\overline{\text{PCI_STOP}}$	$\overline{\text{PWR_DWN}}$	CPUCLK	PCICLK	PCICLK_F	Other Clocks	Osc.	PLLs
X	X	0	Low	Low	Low	Low	Off	Off
0	0	1	Low	Low	Running	Running	Running	Running
0	1	1	Low	Running	Running	Running	Running	Running
1	0	1	Running	Low	Running	Running	Running	Running
1	1	1	Running	Running	Running	Running	Running	Running

Notes:

- Target frequency is modulated by percentage shown (max.) when $\overline{\text{SEL_SS}} = 0$.
- TCLK supplied on the XTALIN pin in Test Mode.

Maximum Ratings

(Above which the useful life may be impaired. For user guidelines, not tested.)

Supply Voltage -0.5 to +7.0V
 Input Voltage -0.5V to $V_{DD}+0.5$

Storage Temperature (Non-Condensing) ... -65°C to +150°C
 Max. Soldering Temperature (10 sec) +260°C
 Junction Temperature +150°C
 Package Power Dissipation 1W
 Static Discharge Voltage >2000V
 (per MIL-STD-883, Method 3015, like V_{DD} pins tied together)

Operating Conditions^[4]

Parameter	Description	Min.	Max.	Unit
AV_{DD} , V_{DDPCI} , V_{DDUSB} , V_{DDREF}	Analog and Digital Supply Voltage	3.135	3.465	V
V_{DDCPU}	CPU Supply Voltage	2.375	2.625	V
V_{DDAPIC}	APIC Supply Voltage	2.375	2.625	V
T_A	Operating Temperature, Ambient	0	70	°C
C_L	Max. Capacitive Load on CPUCLK PCICLK APIC, REF USB		20 30 20 20	pF
$f_{(REF)}$	Reference Frequency, Oscillator Nominal Value	14.318	14.318	MHz

Electrical Characteristics Over the Operating Range

Parameter	Description	Test Conditions		Min.	Max.	Unit
V_{IH}	High-level Input Voltage	Except Crystal Inputs ^[5]		2.0		V
V_{IL}	Low-level Input Voltage	Except Crystal Inputs ^[5]			0.8	V
V_{OH}	High-level Output Voltage ^[6]	$V_{DDCPU} = V_{DDAPIC} = 2.375V$	$I_{OH} = 12\text{ mA}$ CPUCLK $I_{OH} = 18\text{ mA}$ APIC	2.0		V
V_{OL}	Low-level Output Voltage ^[6]	$V_{DDCPU} = V_{DDAPIC} = 2.375V$	$I_{OL} = 12\text{ mA}$ CPUCLK $I_{OL} = 18\text{ mA}$ APIC		0.4	V
V_{OH}	High-level Output Voltage ^[6]	V_{DDPCI} , AV_{DD} , V_{DDREF} , $V_{DDUSB} = 3.135V$	$I_{OH} = 14.5\text{ mA}$ PCICLK $I_{OH} = 16\text{ mA}$ USBCLK $I_{OH} = 16\text{ mA}$ REF	2.4		V
V_{OL}	Low-level Output Voltage ^[6]	V_{DDPCI} , AV_{DD} , V_{DDREF} , $V_{DDUSB} = 3.135V$	$I_{OL} = 9.4\text{ mA}$ PCICLK $I_{OL} = 9\text{ mA}$ USBCLK $I_{OL} = 9\text{ mA}$ REF		0.4V	V
I_{IH}	Input High Current	$V_{IH} = V_{DD}$		-10	+10	μA
I_{IL}	Input Low Current	$V_{IL} = 0V$			10	μA
I_{OZ}	Output Leakage Current	Three-state		-10	+10	μA
I_{DD25}	Power Supply Current for 2.5V Clocks ^[6]	$V_{DDCPU} = 2.625V$, $V_{IN} = 0$ or V_{DD} , Loaded Outputs, CPU = 66.6 MHz			70	mA
I_{DD25}	Power Supply Current for 2.5V Clocks ^[6]	$V_{DDCPU} = 2.625V$, $V_{IN} = 0$ or V_{DD} , Loaded Outputs, CPU = 100 MHz			100	mA
I_{DD33}	Power Supply Current for 3.3V Clocks ^[6]	$V_{DD} = 3.465V$, $V_{IN} = 0$ or V_{DD} , Loaded Outputs			170	mA
I_{DDS}	Power-down Current ^[6]	Current draw in powerdown state			500	μA

Notes:

4. Electrical parameters are guaranteed with these operating conditions.
5. Crystal Inputs have CMOS thresholds.
6. Parameter is guaranteed by design and characterization. Not 100% tested in production.

Switching Characteristics^[6, 7]

Parameter	Output	Description	Test Conditions	Min.	Typ.	Max.	Unit	
t ₁	All	Output Duty Cycle ^[8]	t ₁ = t _{1A} ÷ t _{1B}	45	50	55	%	
t ₂	CPUCLK, APIC	CPU and APIC Clock Rising and Falling Edge Rate	Between 0.4V and 2.0V	-1,-11S, -12S,-13S, -21S only	1.0		4.0	V/ns
				-31S only	0.8		4.0	V/ns
t ₂	PCICLK	PCI Clock Rising and Falling Edge Rate	Between 0.4V and 2.4V	-1,-11S, -12S,-13S, -21S only	1.0		4.0	V/ns
				-31S only	0.9		4.0	V/ns
t ₂	USBCLK, REF	USB, REF Rising and Falling Edge Rate	Between 0.4V and 2.4V	0.5		2.0	V/ns	
t ₃	CPUCLK	CPU Clock Rise Time	Between 0.4V and 2.0V	-1,-11S, -12S,-13S, -21S only	0.4		1.6	ns
				-31S only	0.4		2.0	ns
t ₄	CPUCLK	CPU Clock Fall Time	Between 2.0V and 0.4V	-1,-11S, -12S,-13S, -21S only	0.4		1.6	ns
				-31S only	0.4		2.0	ns
t ₅	CPUCLK	CPU-CPU Clock Skew	Measured at 1.25V		100	175	ps	
t ₆	CPUCLK, PCICLK	CPU-PCI Clock Skew ^[9]	Measured at 1.25V for 2.5V clocks, and at 1.5V for 3.3V clocks	-1,-11S, -12S,-13S, -21S only	1.5		4.0	ns
				-31S only	-1		1	ns
t ₇	PCICLK, PCICLK	PCI-PCI Clock Skew	Measured at 1.5V			250	ps	
t ₈	CPUCLK, APIC	CPU-APIC Clock Skew ^[10]	Measured at 1.25V for 2.5V clocks	-21S only	2.0		4.5	ns
t ₉	APIC	APIC-APIC Clock Skew	Measured at 1.25V		100	175	ps	
t ₁₀	CPUCLK	Cycle-Cycle Clock Jitter	Measured at 1.25V	-1,-11S, -12S,-13S, -21S only		200	250	ps
				-31S only		250	350	ps
t ₁₁	PCICLK	Cycle-Cycle Clock Jitter	Measured at 1.5V		250	500	ps	
t ₁₂	CPUCLK, PCICLK	Power-up Time	CPU, PCI clock stabilization from power-up			3	ms	

Notes:

7. All parameters specified with loaded outputs.
8. Duty cycle is measured at 1.5V when V_{DD} = 3.3V. When V_{DD} = 2.5V, duty cycle is measured at 1.25V.
9. PCI lags CPU for -11S, -12S, -13S, -14S, -21S options.
10. APIC lags CPU for -21S option.

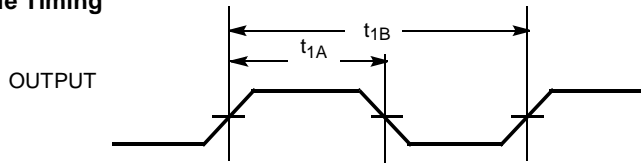
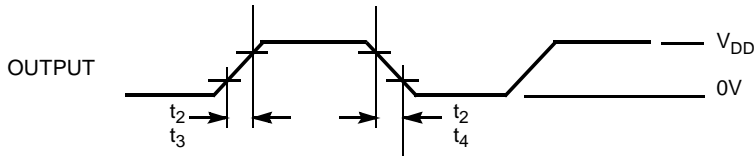
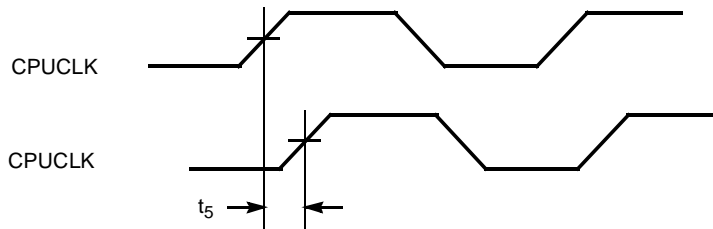
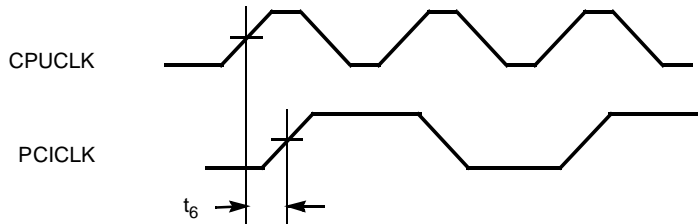
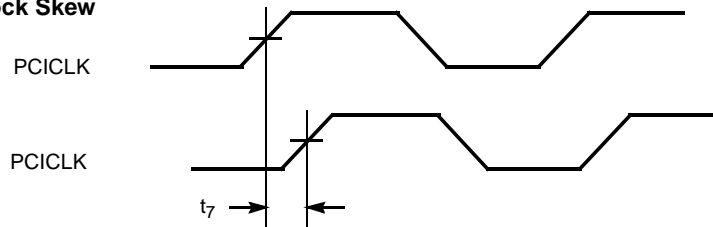
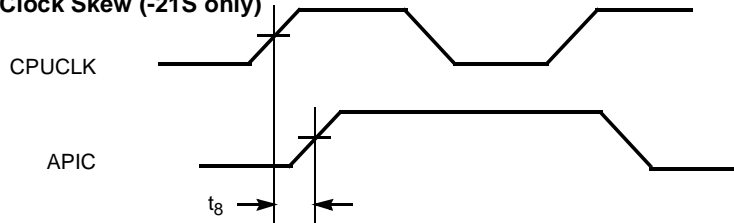
Switching Waveforms
Duty Cycle Timing

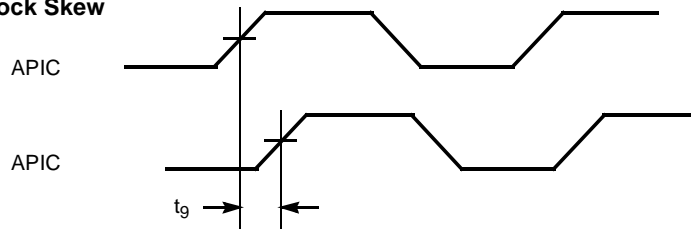
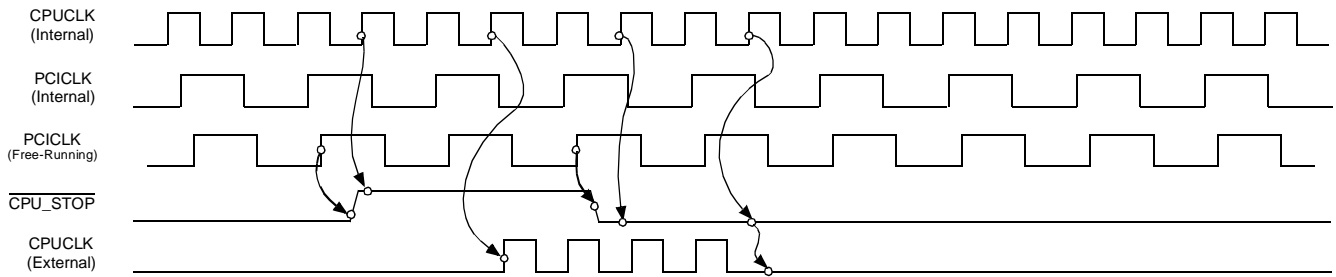
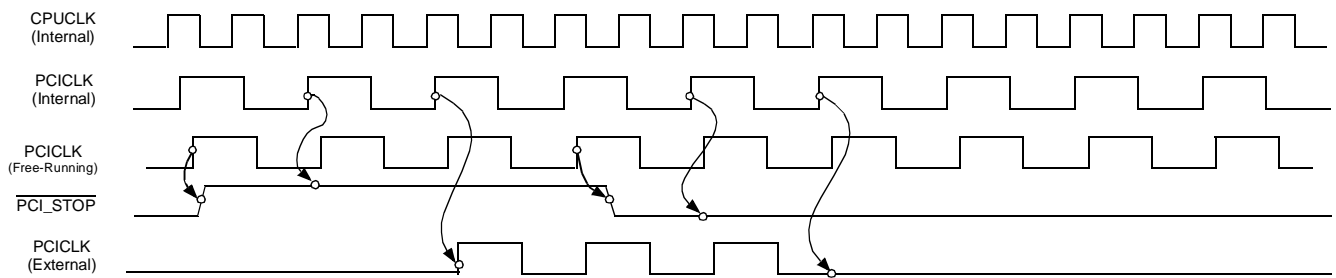
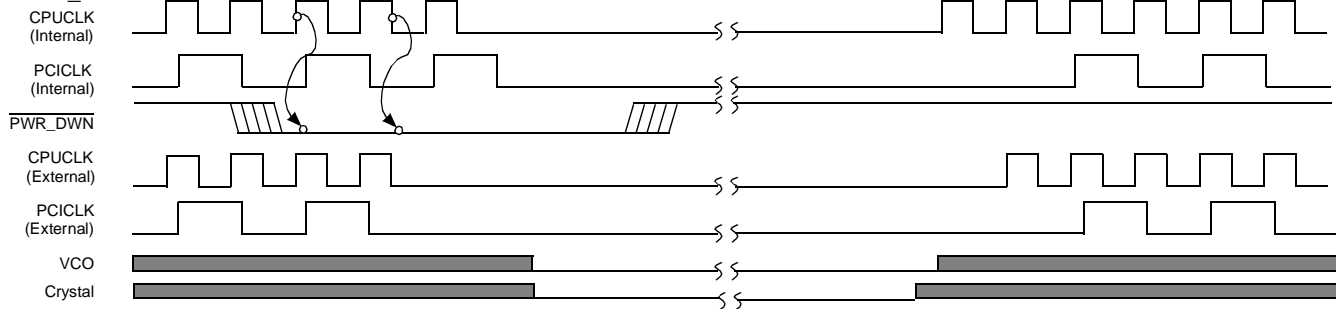
All Outputs Rise/Fall Time

CPU-CPU Clock Skew

CPU-PCI Clock Skew

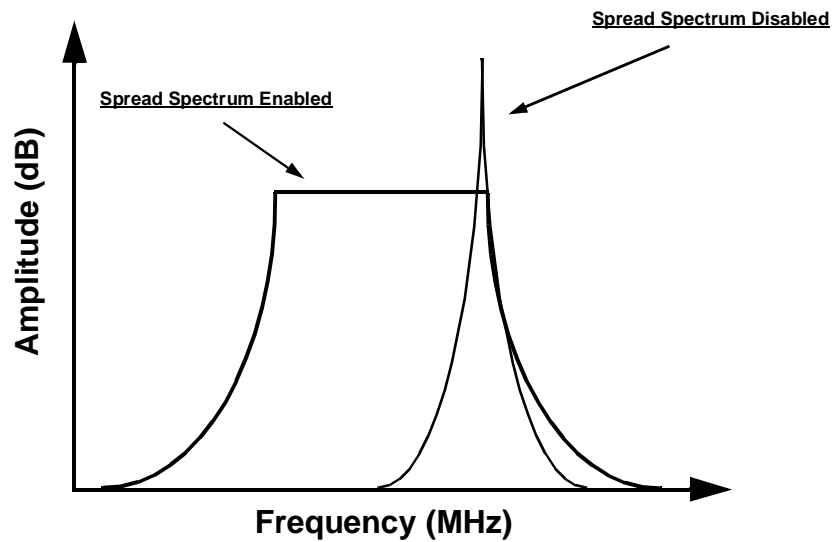
PCI-PCI Clock Skew

CPU-APIC Clock Skew (-21S only)

Switching Waveforms (continued)
APIC-APIC Clock Skew

CPU_STOP

PCI_STOP

PWR_DOWN

Shaded section on the VCO and Crystal waveforms indicates that the VCO and crystal oscillator are active, and there is a valid clock.

SPREAD SPECTRUM CLOCKING



Description	Configuration	Outputs	Min.	Max.	Unit
Modulation Frequency	All (except -1)		30.0	33.0	kHz
Down Spread Margin at the Fundamental Frequency	-11S, -31S	CPU, PCI	0.0	-0.6	%
Down Spread Margin at the Fundamental Frequency	-12S	CPU, PCI	0.0	-1.0	%
Down Spread Margin at the Fundamental Frequency	-13S	CPU, PCI	0.0	-1.5	%
Down Spread Margin at the Fundamental Frequency	-21S	CPU, PCI, APIC	0.0	-0.6	%

Application Information

Clock traces must be terminated with either series or parallel termination, as they are normally done.

Application Circuit

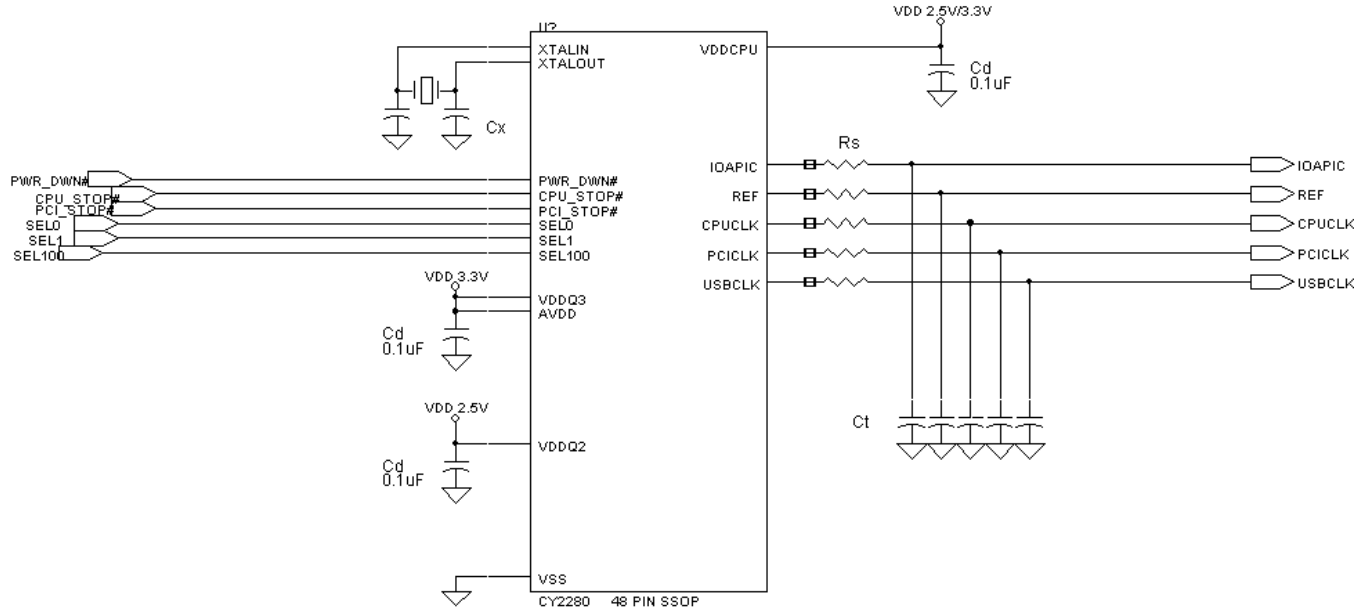

Cd = DECOUPLING CAPACITORS

Ct = OPTIONAL EMI-REDUCING CAPACITORS

Cx = OPTIONAL LOAD MATCHING CAPACITOR

Rs = SERIES TERMINATING RESISTORS

Summary

- A parallel-resonant crystal should be used as the reference to the clock generator. The operating frequency and CLOAD of this crystal should be as specified in the data sheet. Optional trimming capacitors may be needed if a crystal with a different CLOAD is used. Footprints must be laid out for flexibility.
- Surface mount, low-ESR, ceramic capacitors should be used for filtering. Typically, these capacitors have a value of 0.1 μ F. In some cases, smaller value capacitors may be required.
- The value of the series terminating resistor satisfies the following equation, where R_{trace} is the loaded characteristic impedance of the trace, R_{out} is the output impedance of the clock generator (specified in the data sheet), and R_{series} is the series terminating resistor.

$$R_{series} > R_{trace} - R_{out}$$
- Footprints must be laid out for optional EMI-reducing capacitors, which should be placed as close to the terminating resistor as is physically possible. Typical values of these capacitors range from 4.7 pF to 22 pF.
- A Ferrite Bead **may** be used to isolate the Board VDD from the clock generator VDD island. Ensure that the Ferrite Bead offers greater than 50 Ω impedance at the clock frequency, under loaded DC conditions. Please refer to the application note "Layout and Termination Techniques for Cypress Clock Generators" for more details.
- If a Ferrite Bead is used, a 10 μ F–22 μ F tantalum bypass capacitor should be placed close to the Ferrite Bead. This capacitor prevents power supply droop during current surges.

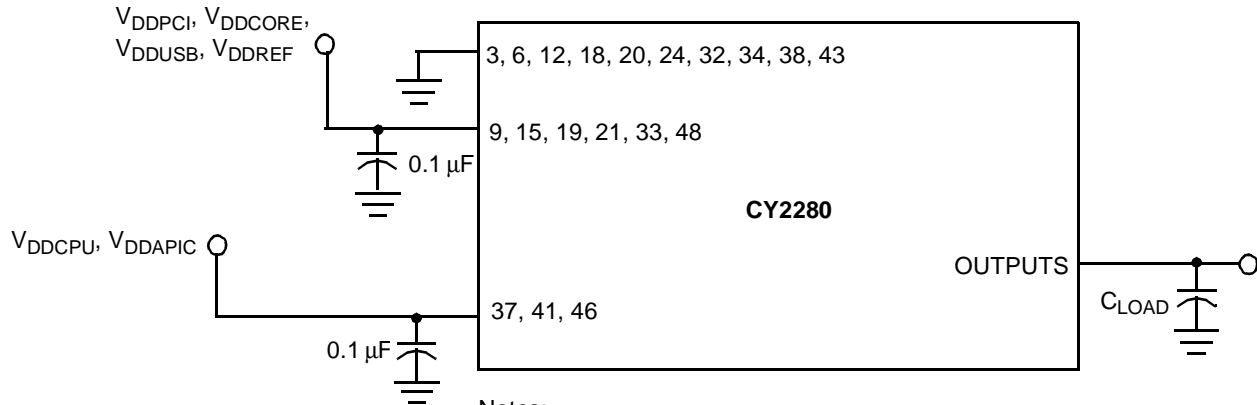
Test Circuit

Notes:
 Each supply pin must have an individual decoupling capacitor
 All capacitors must be placed as close to the pins as is possible.

Ordering Information

Ordering Code	Package Name	Package Type	Operating Range
CY2280PVC-1	O48	48-Pin SSOP	Commercial
CY2280PVC-11S	O48	48-Pin SSOP	Commercial
CY2280PVC-12S	O48	48-Pin SSOP	Commercial
CY2280PVC-13S	O48	48-Pin SSOP	Commercial
CY2280PVC-14S	O48	48-Pin SSOP	Commercial
CY2280PVC-21S	O48	48-Pin SSOP	Commercial
CY2280PVC-31S	O48	48-Pin SSOP	Commercial

Document #: 38-00694-C

Package Diagram

48-Lead Shrink Small Outline Package O48

