

4-channel BTL driver for CD-ROM drives

BA5952AFP

The BA5952AFP is a four-channel BTL driver IC for driving the motors and actuators in products such as CD ROM drives. Two of the channels use current feedback to minimize the current phase shift caused by the influence of load inductance.

●Applications

CD-ROM drives, DVD drives, DVD ROM drives.

●Features

- 1) Two channels are current-drive-type BTL drivers for two-shaft actuators. One channel is a voltage-drive-type BTL driver for transport motors, and the last is a current-drive-type BTL driver for loading motors.
 - 2) Wide dynamic range (4.0V (typ.) when $PreV_{CC} = 12V$, $PV_{CC} = 5V$, and $R_L = 8\Omega$).
 - 3) Level shift circuit on chip.
 - 4) Thermal shutdown circuit on chip.
- * Dual-shaft actuator drivers
These drivers use current feedback to minimize the current phase shift cause by the influence of load inductance. Output structure is power op-amp to minimize back-rush noise.
 - * Transport motor driver
Differential input and signal addition is possible by connecting general-purpose op-amps to the inputs.
 - * Loading driver
Performs forward and reverse drive with transistor logic input. Can also be used as a linear BTL driver.

●Absolute maximum ratings ($T_a = 25^\circ C$)

Parameter	Symbol	Limits	Unit
Power supply voltage	$PreV_{CC}$, $PV_{CC1/2}$	13.5	V
Power dissipation	P_d	1.7*	W
Operating temperature	T_{opr}	$-35 \sim +85$	$^\circ C$
Storage temperature	T_{stg}	$-55 \sim +150$	$^\circ C$

* When mounted on a 70mm×70mm×1.6mm glass epoxy board.
Reduced by 13.6mW for each increase in T_a of 1 $^\circ C$ over 25 $^\circ C$.

●Recommended operating conditions ($T_a = 25^\circ C$)

Parameter	Symbol	Limits	Unit
Power supply voltage	$PreV_{CC}$	4.3~13.2	V
	PV_{CC1}	4.3~ $PreV_{CC}$	V
	PV_{CC2}	4.3~ $PreV_{CC}$	V

● Block diagram

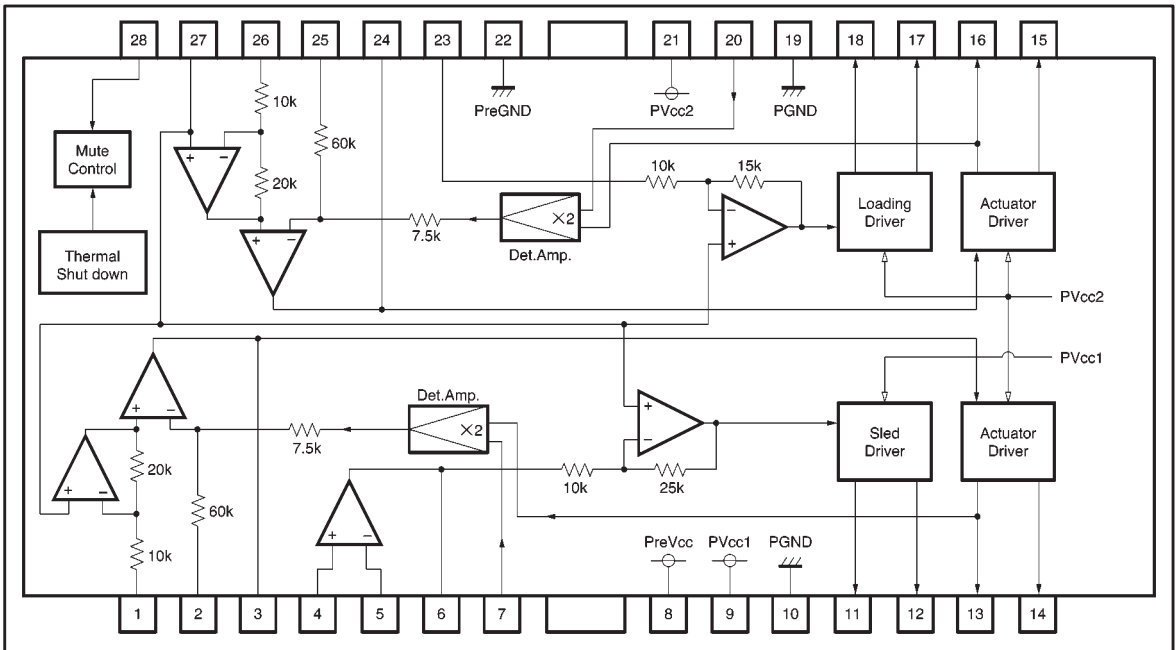

● Pin descriptions

Pin No.	Pin name	Function
1	VINFC	Focus drive input
2	CFCerr1	For connection of capacitor for the error amp filter
3	CFCerr2	For connection of capacitor for the error amp filter
4	VINSL+	Op-amp input (+) for the sled driver
5	VINSL-	Op-amp input (-) for the sled driver
6	VOSL	Op-amp output for the sled driver
7	VNFFC	Focus driver feedback pin
8	PreVcc	Pre Vcc
9	PVcc1	Power Vcc for sled driver block
10	PGND	Ground for sled driver block
11	VOSL-	Sled driver output (-)
12	VOSL+	Sled driver output (+)
13	VOFC-	Focus driver output (-)
14	VOFC+	Focus driver output (+)

Pin No.	Pin name	Function
15	VOTK+	Tracking driver output (+)
16	VOTK-	Tracking driver output (-)
17	VOLD+	Loading driver output (+)
18	VOLD-	Loading driver output (-)
19	PGND	Power ground
20	VNFTK	Tracking driver feedback pin
21	PVcc2	Power ground
22	PreGND	Pre ground
23	VINLD	Loading driver input
24	CTKerr2	For connection of capacitor for the error amp filter
25	CTKerr1	For connection of capacitor for the error amp filter
26	VINTK	Tracking driver input
27	BIAS	Bias input
28	MUTE	Mute control

Notes: The indicated polarities for the output pins are for when all inputs are (+).

The output H bridge power supply pins are PVcc2 for the focus, tracking, and loading channels, and Vcc1 for the pre-block uses PreVcc.

Always ensure that PreVcc ≥ PVcc.

● Input/output circuits

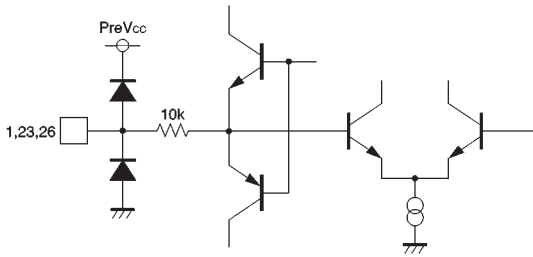

Fig.1

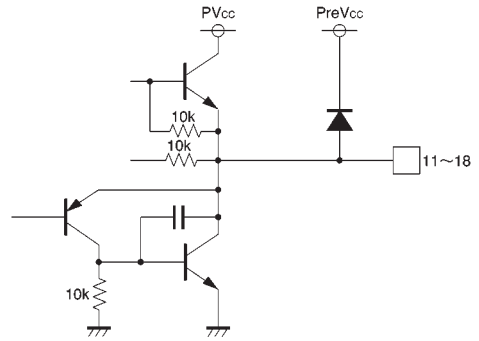

Fig.2

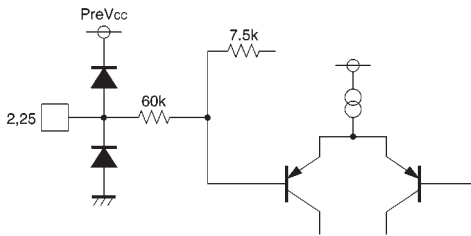

Fig.3

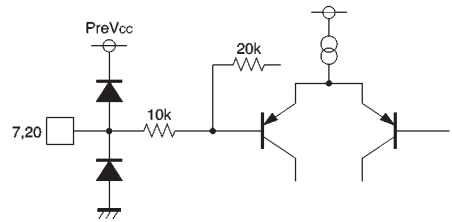

Fig.4

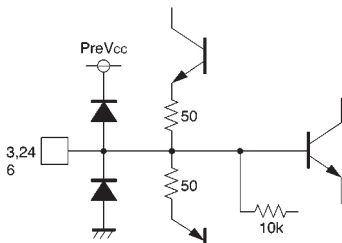

Fig.5

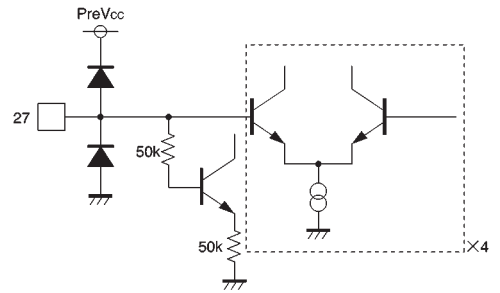

Fig.6

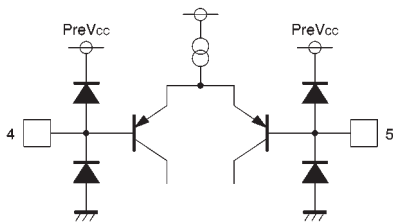

Fig.7

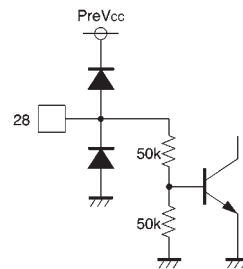

Fig.8

- Electrical characteristics (unless otherwise noted, $T_a = 25^\circ\text{C}$, $\text{PreV}_{\text{CC}} = 12\text{V}$, $\text{PV}_{\text{CC}1} = \text{PV}_{\text{CC}2} = 5\text{V}$,
BIAS = 2.5V, $R_L = 8\Omega$, $R_d = 0.5\Omega$, $C = 100\text{pF}$)

Parameter	Symbol	Min.	Typ.	Max.	Unit	Conditions
Quiescent current	I_{CC}	—	18	27	mA	
〈Actuator driver〉						
Output offset current	I_{OO}	−6	—	6	mA	
Maximum output amplitude	V_{OM}	3.6	4.0	—	V	
Transmission gain	g_m	1.3	1.5	1.7	A / V	$V_{\text{IN}} = \text{BIAS} \pm 0.2\text{V}$
〈Transport motor driver〉						
Input op-amp same phase input range	V_{ICM}	−0.3	—	11.0	V	
Input bias current (outflow current)	I_{BOP}	—	30	300	nA	
Output high level voltage	V_{OHOP}	10.8	11.1	—	V	
Output low level voltage	V_{OLOP}	—	0.8	1.1	V	
Output offset voltage	V_{OOSL}	−100	0	100	mV	
Maximum output amplitude	V_{OMSL}	3.6	4.0	—	V	
Closed-circuit voltage gain	G_{VSL}	18.0	20.0	22.0	dB	$V_{\text{IN}} = \text{BIAS} \pm 0.2\text{V}$
〈Loading driver〉						
Offset voltage	V_{OOILD}	−50	0	50	mV	
Maximum output amplitude	V_{OMLD}	3.6	4.0	—	V	
Voltage gain	G_{VLD}	13.5	15.5	17.5	dB	$V_{\text{IN}} = \text{BIAS} \pm 0.2\text{V}$
F/R gain differential	ΔG_{VLD}	0	1	2	dB	$V_{\text{IN}} = \text{BIAS} \pm 0.2\text{V}$
〈Mute logic〉						
Mute on voltage	V_{MUTE1}	0	—	0.5	V	All channels off
Mute off voltage	V_{MUTE2}	2.0	—	—	V	All channels on

©Not designed for radiation resistance.

● Measurement circuit

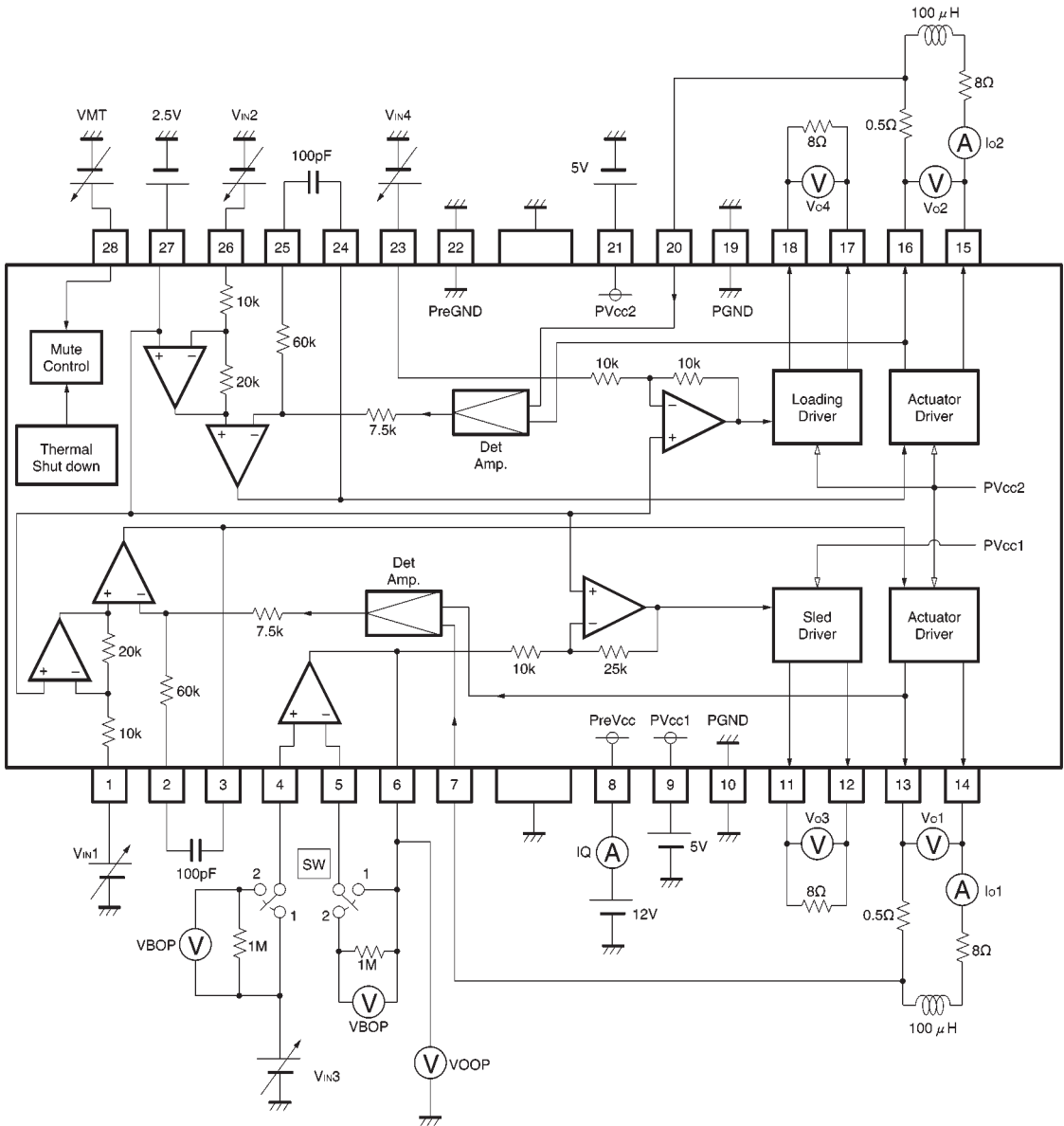

Fig.9

●Application example

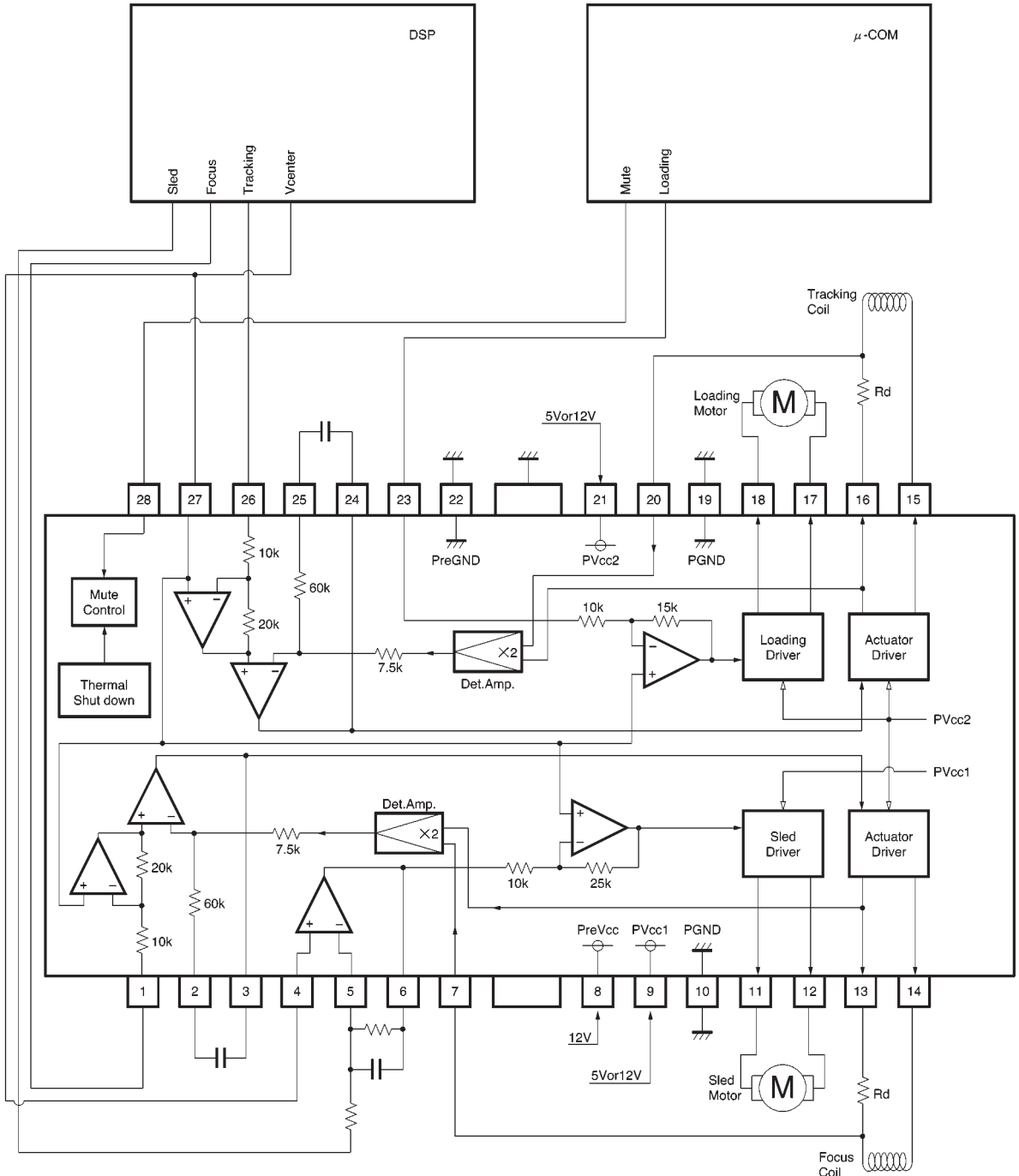

Fig.10

● Operation notes

- (1) This IC has a built in thermal shutdown circuit that mutes the output current when the chip temperature reaches 175°C (typ.). The hysteresis is set to 25°C (typ.), so the driver circuits start up again when the chip temperature falls to 150°C (typ.).
- (2) The driver buffer is switched off when the supply voltage falls below 3.8V (typ.), and is switched back on when the voltage reaches 4.0V (typ.) again.
- (3) The mute circuit logic is active low.
- (4) Mute is applied when the buffer pin voltage falls below 1.4V (typ.). Normally, operate with this at 1.8V at least.

- (5) Connect a bypass capacitor between the bases of the power supply pins of this IC.

〈Supplement〉

Current-feedback driver

The transmission gain (output current/input voltage) is given by:

$$g_m = \frac{1}{R_d + R_{WIRE}} \text{ (A/V)}$$

R_{WIRE} is the total gold wire resistance inside the package (0.15Ω ± 0.05Ω) (typ.).

● Electrical characteristics curves

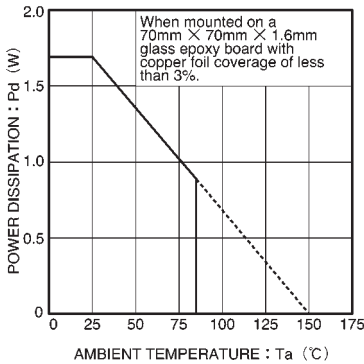

Fig. 11 Thermal dissipation curve

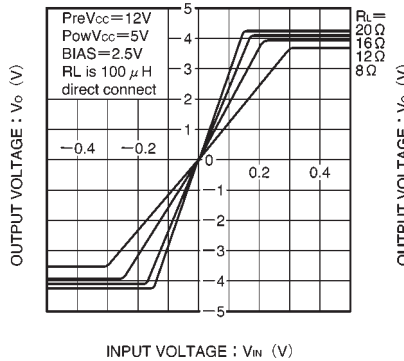

Fig. 12 Driver I/O characteristics (focus and tracking)

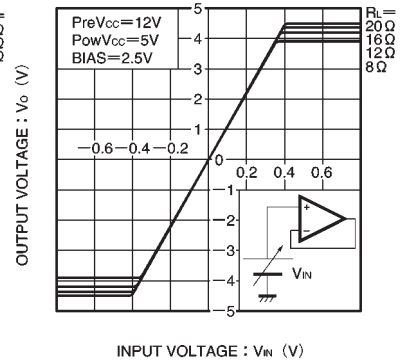

Fig. 13 Driver I/O characteristics (sled)

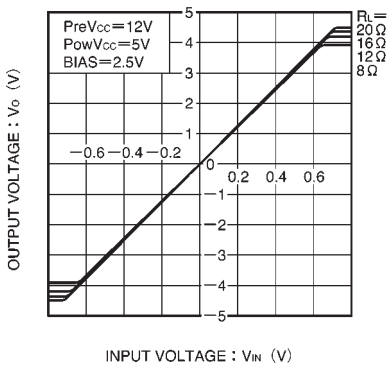

Fig. 14 Driver I/O characteristics (loading)

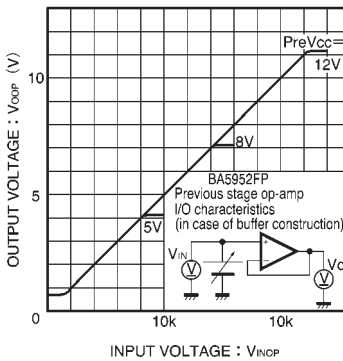

Fig. 15 Op-amp I/O characteristics

● External dimensions (Units: mm)

