

Logic level TOPFET

PIP3102-R

DESCRIPTION

Monolithic logic level protected power MOSFET using **TOPFET2** technology assembled in a 5 pin surface mounting plastic package.

APPLICATIONS

- General purpose switch for driving
- lamps
 - motors
 - solenoids
 - heaters

FEATURES

- TrenchMOS output stage with low on-state resistance
- Separate input pin for higher frequency drive
- 5 V logic compatible input
- Separate supply pin for logic and protection circuits with low operating current
- Overtemperature protection
- Drain current limiting
- Short circuit load protection
- Latched overload trip state reset by the protection pin
- Diagnostic flag pin indicates protection supply connected, overtemperature condition, overload tripped state, or open circuit load (detected in the off-state)
- ESD protection on all pins
- Overvoltage clamping

QUICK REFERENCE DATA

SYMBOL	PARAMETER	MAX.	UNIT
V_{DS}	Continuous drain source voltage	50	V
I_D	Continuous drain current	30	A
P_{tot}	Total power dissipation	90	W
T_j	Continuous junction temperature	150	°C
$R_{DS(ON)}$	Drain-source on-state resistance	28	mΩ
SYMBOL	PARAMETER	NOM.	UNIT
V_{PS}	Protection supply voltage	5	V

FUNCTIONAL BLOCK DIAGRAM

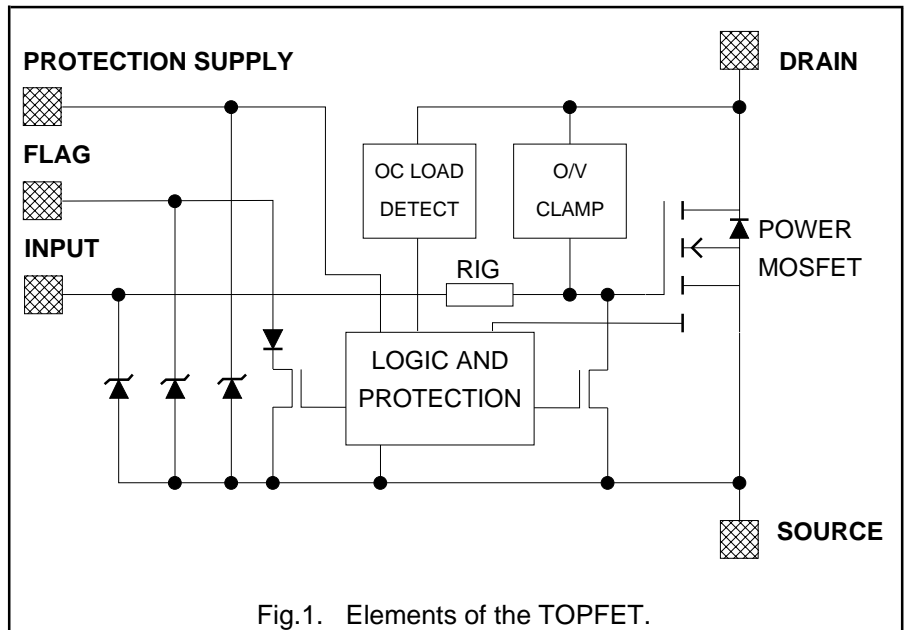

PINNING - SOT426

PIN	DESCRIPTION
1	input
2	flag
3	(connected to mb)
4	protection supply
5	source
mb	drain

PIN CONFIGURATION

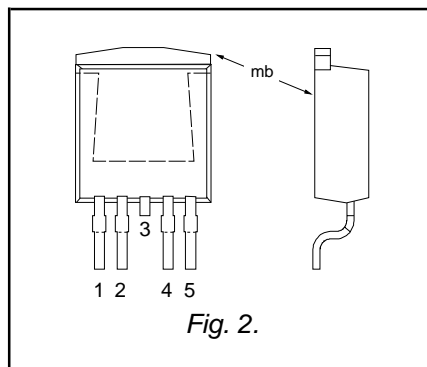

SYMBOL

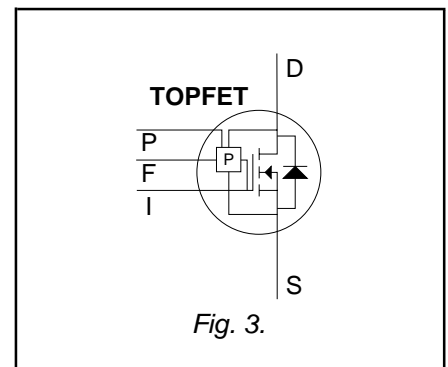

Logic level TOPFET

PIP3102-R

LIMITING VALUES

Limiting values in accordance with the Absolute Maximum Rating System (IEC 134)

SYMBOL	PARAMETER	CONDITIONS	MIN.	MAX.	UNIT
V_{DS}	Continuous voltage Drain source voltage ¹	$V_{IS} = 0 \text{ V}$	-	50	V
I_D	Continuous currents Drain current	$V_{PS} = 5 \text{ V}; T_{mb} = 25^\circ\text{C}$ $V_{PS} = 0 \text{ V}; T_{mb} = 85^\circ\text{C}$	-	self - limited 30	A A
I_I	Input current		-5	5	mA
I_F	Flag current		-5	5	mA
I_P	Protection supply current		-5	5	mA
P_{tot}	Thermal Total power dissipation	$T_{mb} = 25^\circ\text{C}$	-	90	W
T_{stg}	Storage temperature		-55	175	$^\circ\text{C}$
T_J	Junction temperature ²	continuous	-	150	$^\circ\text{C}$
T_{sold}	Mounting base temperature	during soldering	-	260	$^\circ\text{C}$

ESD LIMITING VALUE

SYMBOL	PARAMETER	CONDITIONS	MIN.	MAX.	UNIT
V_C	Electrostatic discharge capacitor voltage	Human body model; $C = 250 \text{ pF}; R = 1.5 \text{ k}\Omega$	-	2	kV

OVERLOAD PROTECTION LIMITING VALUE

With an adequate protection supply connected, TOPFET can protect itself from two types of overload - overtemperature and short circuit load.

For overload conditions an n-MOS transistor turns on between the input and source to quickly discharge the power MOSFET gate capacitance.

The drain current is limited to reduce dissipation in case of short circuit load. Refer to OVERLOAD CHARACTERISTICS.

SYMBOL	PARAMETER	REQUIRED CONDITION	MIN.	MAX.	UNIT
V_{DS}	Overload protection³ Drain source voltage	protection supply $V_{PS} \geq 4 \text{ V}$	0	35	V

OVERVOLTAGE CLAMPING LIMITING VALUES

At a drain source voltage above 50 V the power MOSFET is actively turned on to clamp overvoltage transients.

SYMBOL	PARAMETER	CONDITIONS	MIN.	MAX.	UNIT
E_{DSM}	Inductive load turn off Non-repetitive clamping energy	$I_{DM} = 20 \text{ A}; V_{DD} \leq 20 \text{ V}$ $T_{mb} = 25^\circ\text{C}$	-	350	mJ
E_{DRM}	Repetitive clamping energy	$T_{mb} \leq 95^\circ\text{C}; f = 250 \text{ Hz}$	-	45	mJ

¹ Prior to the onset of overvoltage clamping. For voltages above this value, safe operation is limited by the overvoltage clamping energy.

² A higher T_J is allowed as an overload condition but at the threshold $T_{J(TO)}$ the over temperature trip operates to protect the switch.

³ All control logic and protection functions are disabled during conduction of the source drain diode. If the protection circuit was previously latched, it would be reset by this condition.

Logic level TOPFET

PIP3102-R

THERMAL CHARACTERISTIC

SYMBOL	PARAMETER	CONDITIONS	MIN.	TYP.	MAX.	UNIT
$R_{th\ j-mb}$	Thermal resistance Junction to mounting base	-	-	1.2	1.39	K/W

OUTPUT CHARACTERISTICS

Limits are for $-40^{\circ}\text{C} \leq T_{mb} \leq 150^{\circ}\text{C}$; typicals are for $T_{mb} = 25^{\circ}\text{C}$ unless otherwise specified.

SYMBOL	PARAMETER	CONDITIONS	MIN.	TYP.	MAX.	UNIT
$V_{(CL)DSS}$	Off-state Drain-source clamping voltage	$V_{IS} = 0\text{ V}$ $I_D = 10\text{ mA}$	50	-	70	V
I_{DSS}	Drain source leakage current ¹	$I_{DM} = 4\text{ A}$; $t_p \leq 300\ \mu\text{s}$; $\delta \leq 0.01$ $V_{PS} = 0\text{ V}$; $V_{DS} = 40\text{ V}$ $T_{mb} = 25^{\circ}\text{C}$	50 -	60 0.1	70 100	V μA
$R_{DS(ON)}$	On-state Drain-source resistance	$t_p \leq 300\ \mu\text{s}$; $\delta \leq 0.01$; $V_{PS} \geq 4\text{ V}$ $I_{DM} = 10\text{ A}$; $V_{IS} \geq 4.4\text{ V}$ $T_{mb} = 25^{\circ}\text{C}$	- -	- 21	50 28	$\text{m}\Omega$ $\text{m}\Omega$

INPUT CHARACTERISTICS

Limits are for $-40^{\circ}\text{C} \leq T_{mb} \leq 150^{\circ}\text{C}$; typicals are for $T_{mb} = 25^{\circ}\text{C}$ unless otherwise specified.

SYMBOL	PARAMETER	CONDITIONS	MIN.	TYP.	MAX.	UNIT
$V_{IS(TO)}$	Normal operation Input threshold voltage ²	$I_D = 1\text{ mA}$ $T_{mb} = 25^{\circ}\text{C}$	0.6 1.1	- 1.6	2.6 2.1	V V
I_{IS}	Input current	$V_{IS} = 5\text{ V}$	-	16	100	μA
$V_{(CL)IS}$	Input clamping voltage	$I_I = 1\text{ mA}$	5.5	6.4	8.5	V
R_{IG}	Internal series resistance ³	to gate of power MOSFET	-	1.7	-	$\text{k}\Omega$
I_{ISL}	Overload protection latched Input current	$V_{PS} \geq 4\text{ V}$ $V_{IS} = 5\text{ V}$	1	2.7	4	mA

¹ The drain current required for open circuit load detection is switched off when there is no protection supply, in order to ensure a low off-state quiescent current. Refer to OPEN CIRCUIT LOAD DETECTION CHARACTERISTICS.

² The measurement method is simplified if $V_{PS} = 0\text{ V}$, in order to distinguish I_D from I_{DSP} . Refer to OPEN CIRCUIT LOAD DETECTION CHARACTERISTICS.

³ This is not a directly measurable parameter.

Logic level TOPFET

PIP3102-R

PROTECTION SUPPLY CHARACTERISTICSLimits are for $-40^{\circ}\text{C} \leq T_{\text{mb}} \leq 150^{\circ}\text{C}$; typicals are for $T_{\text{mb}} = 25^{\circ}\text{C}$.

SYMBOL	PARAMETER	CONDITIONS	MIN.	TYP.	MAX.	UNIT
V_{PSF}	Protection & detection Threshold voltage ¹	$I_{\text{F}} = 100 \mu\text{A}$; $V_{\text{DS}} = 5 \text{ V}$	2.5	3.45	4	V
I_{PS} , I_{PSL}	Normal operation or protection latched Supply current	$V_{\text{PS}} = 4.5 \text{ V}$	-	210	450	μA
$V_{(\text{CL})\text{PS}}$	Clamping voltage	$I_{\text{p}} = 1.5 \text{ mA}$	5.5	6.5	8.5	V
V_{PSR} t_{pr}	Overload protection latched Reset voltage Reset time	$V_{\text{PS}} \leq 1 \text{ V}$	1 10	1.8 45	3 120	V μs

OPEN CIRCUIT LOAD DETECTION CHARACTERISTICSAn open circuit load condition can be detected while the TOPFET is in the off-state. Refer to TRUTH TABLE. $V_{\text{PS}} = 5 \text{ V}$. Limits are for $-40^{\circ}\text{C} \leq T_{\text{mb}} \leq 150^{\circ}\text{C}$ and typicals are for $T_{\text{mb}} = 25^{\circ}\text{C}$.

SYMBOL	PARAMETER	CONDITIONS	MIN.	TYP.	MAX.	UNIT
I_{DSP}	Off-state drain current ²	$V_{\text{IS}} = 0 \text{ V}$; $2 \text{ V} \leq V_{\text{DS}} \leq 40 \text{ V}$	0.9	1.8	2.7	mA
V_{DSF}	Drain threshold voltage ³	$V_{\text{IS}} = 0 \text{ V}$	0.2	1	2	V
V_{ISF}	Input threshold voltage ⁴	$I_{\text{D}} = 100 \mu\text{A}$	0.3	0.8	1.1	V

OVERLOAD CHARACTERISTICS $T_{\text{mb}} = 25^{\circ}\text{C}$ unless otherwise specified.

SYMBOL	PARAMETER	CONDITIONS	MIN.	TYP.	MAX.	UNIT
I_{D}	Short circuit load Drain current limiting	$V_{\text{PS}} > 4 \text{ V}$ $V_{\text{IS}} = 5 \text{ V}$; $-40^{\circ}\text{C} \leq T_{\text{mb}} \leq 150^{\circ}\text{C}$	28.5	44	60	A
$P_{\text{D}(\text{TO})}$ T_{DSC}	Overload protection Overload power threshold Characteristic time	$V_{\text{PS}} > 4 \text{ V}$ device trips if $P_{\text{D}} > P_{\text{D}(\text{TO})}$ which determines trip time ⁵	75 250	185 380	250 600	W μs
$T_{\text{j}(\text{TO})}$	Overtemperature protection Threshold temperature	$V_{\text{PS}} = 5 \text{ V}$ from $I_{\text{D}} \geq 4 \text{ A}$ or $V_{\text{DS}} > 0.2 \text{ V}$	150	170	-	$^{\circ}\text{C}$

¹ When V_{PS} is less than V_{PSF} the flag pin indicates low protection supply voltage. Refer to TRUTH TABLE.² The drain source current which flows in a normal load when the protection supply is high and the input is low.³ If $V_{\text{DS}} < V_{\text{DSF}}$ then the flag indicates open circuit load.⁴ For open circuit load detection, V_{IS} must be less than V_{ISF} .⁵ Trip time t_{dsc} varies with overload dissipation P_{D} according to the formula $t_{\text{dsc}} \approx T_{\text{DSC}} / \ln[P_{\text{D}} / P_{\text{D}(\text{TO})}]$.

Logic level TOPFET

PIP3102-R

TRUTH TABLE

For normal, open-circuit load and overload conditions or inadequate protection supply voltage. Assumes proper external pull-up for flag pin. Refer to FLAG CHARACTERISTICS.

CONDITION	PROTECTION	INPUT	FLAG	OUTPUT
Normal on-state	1	1	0	ON
Normal off-state	1	0	0	OFF
Open circuit load	1	1	0	ON
Open circuit load	1	0	1	OFF
Short circuit load ¹	1	1	1	OFF
Over temperature	1	X	1	OFF
Low protection supply voltage	0	1	1	ON
Low protection supply voltage	0	0	1	OFF

KEY '0' equals low
 '1' equals high
 'X' equals don't care.

FLAG CHARACTERISTICS

The flag is an open drain transistor which requires an external pull-up circuit. Limits are for $-40^{\circ}\text{C} \leq T_{\text{mb}} \leq 150^{\circ}\text{C}$; typicals are for $T_{\text{mb}} = 25^{\circ}\text{C}$.

SYMBOL	PARAMETER	CONDITIONS	MIN.	TYP.	MAX.	UNIT
V_{FSF}	Flag 'low'	normal operation; $V_{\text{PS}} = 5\text{ V}$				
	Flag voltage	$I_{\text{F}} = 100\ \mu\text{A}$	-	0.8	1	V
I_{FSF}	Flag saturation current	$V_{\text{FS}} = 5\text{ V}$	-	10	-	mA
I_{FSO}	Flag 'high'	overload or fault				
	Flag leakage current	$V_{\text{FS}} = 5\text{ V}$	-	0.1	10	μA
$V_{(\text{CL})\text{FS}}$	Flag clamping voltage	$I_{\text{F}} = 100\ \mu\text{A}$	5.5	6.2	8.5	V
R_{F}	Application information Suitable external pull-up resistance	$V_{\text{FF}} = 5\text{ V}$	-	47	-	k Ω

SWITCHING CHARACTERISTICS

$T_{\text{mb}} = 25^{\circ}\text{C}$; $R_{\text{I}} = 50\ \Omega$; $R_{\text{IS}} = 50\ \Omega$; $V_{\text{DD}} = 15\text{ V}$; resistive load $R_{\text{L}} = 10\ \Omega$.

SYMBOL	PARAMETER	CONDITIONS	MIN.	TYP.	MAX.	UNIT
t_{don}	Turn-on delay time	$V_{\text{IS}}: 0\text{ V} \Rightarrow 5\text{ V}$	-	1.8	5	μs
t_{r}	Rise time		-	3.5	8	μs
t_{doff}	Turn-off delay time	$V_{\text{IS}}: 5\text{ V} \Rightarrow 0\text{ V}$	-	11	30	μs
t_{f}	Fall time		-	5	12	μs

¹ In this condition the protection circuit is latched. To reset the latch the protection pin must be taken low. Refer to PROTECTION SUPPLY CHARACTERISTICS.

Logic level TOPFET

PIP3102-R

CAPACITANCES

$T_{mb} = 25\text{ }^\circ\text{C}$; $f = 1\text{ MHz}$

SYMBOL	PARAMETER	CONDITIONS	MIN.	TYP.	MAX.	UNIT
C_{iss}	Input capacitance	$V_{DS} = 25\text{ V}$; $V_{IS} = 0\text{ V}$	-	710	1050	pF
C_{oss}	Output capacitance	$V_{DS} = 25\text{ V}$; $V_{IS} = 0\text{ V}$	-	370	550	pF
C_{rss}	Reverse transfer capacitance	$V_{DS} = 25\text{ V}$; $V_{IS} = 0\text{ V}$	-	26	40	pF
C_{ps0}	Protection supply pin capacitance	$V_{PS} = 5\text{ V}$	-	22	-	pF
C_{fs0}	Flag pin capacitance	$V_{FS} = 5\text{ V}$; $V_{PS} = 0\text{ V}$	-	12	-	pF

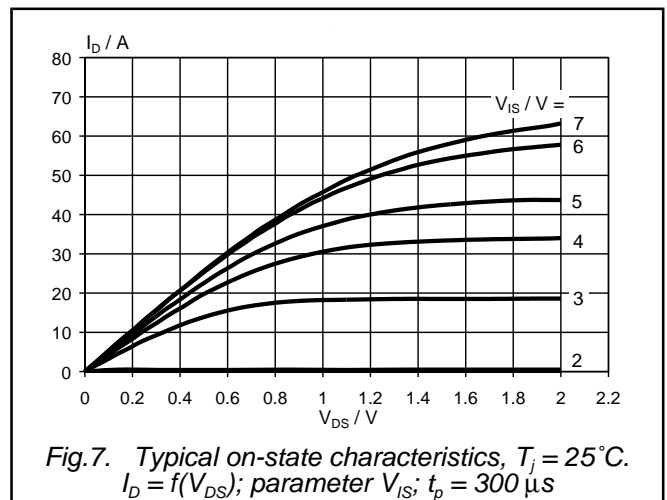
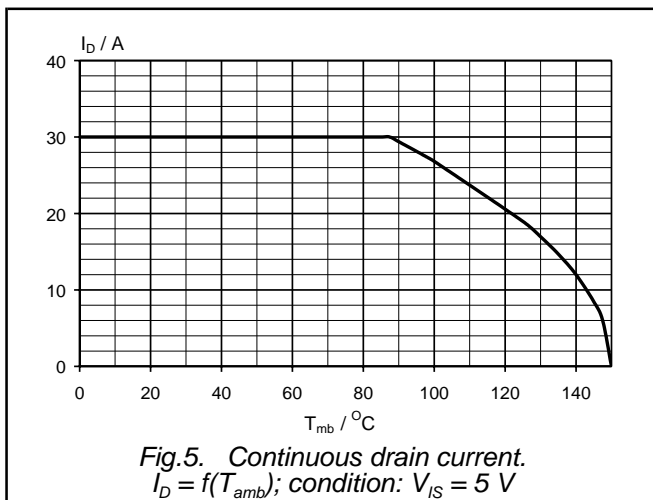
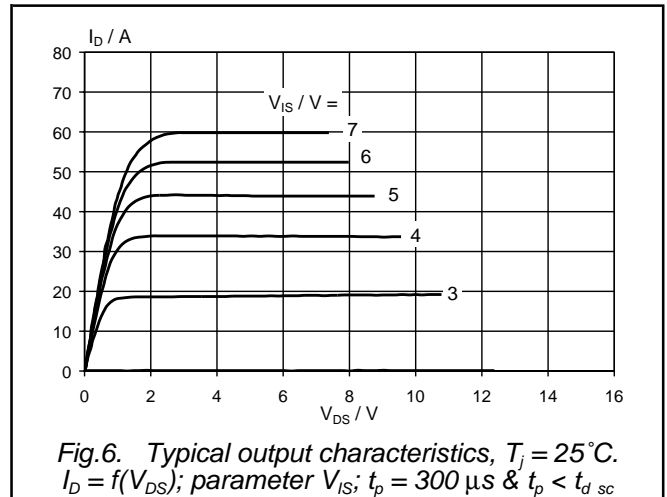
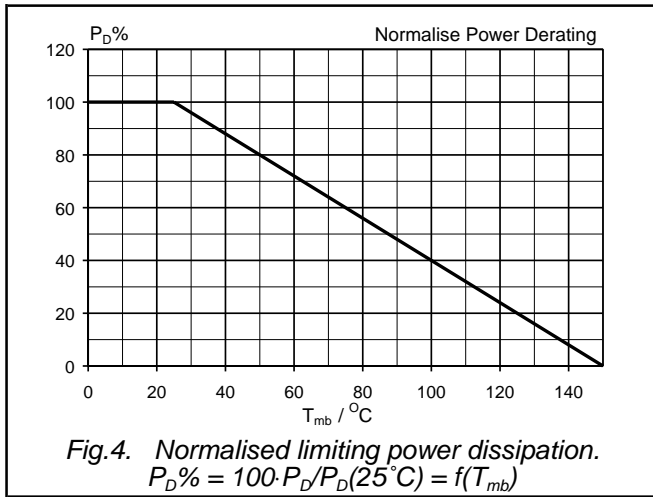

Logic level TOPFET

PIP3102-R

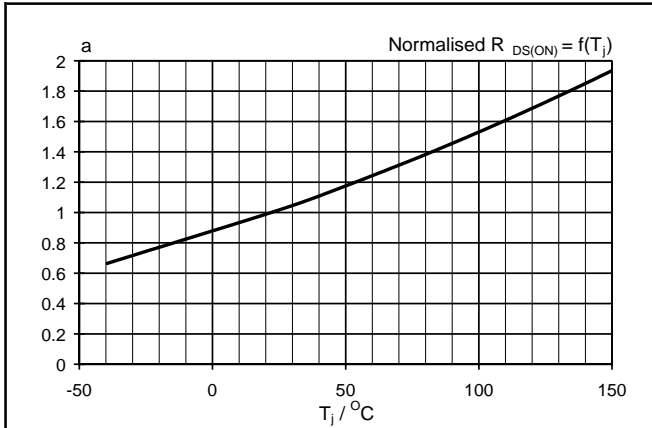

Fig. 8. Normalised drain-source on-state resistance. $a = R_{DS(ON)}/R_{DS(ON)25^\circ C} = f(T_j)$; $I_D = 10\text{ A}$; $V_{IS} = 4.4\text{ V}$

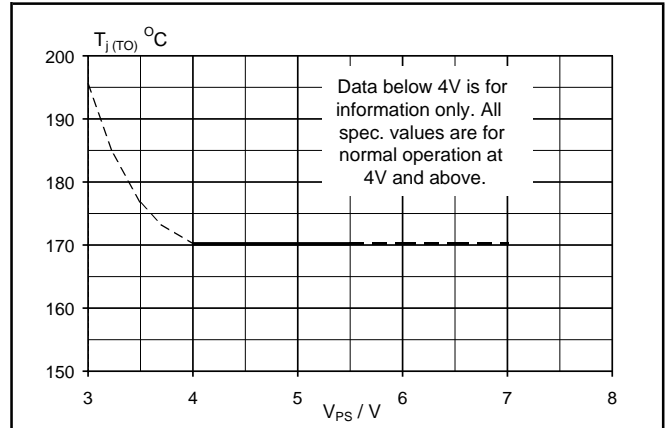

Fig. 11. Typical overtemperature protection threshold. $T_{j(TO)} = f(V_{PS})$; conditions: $V_{IS} = 5\text{ V}$

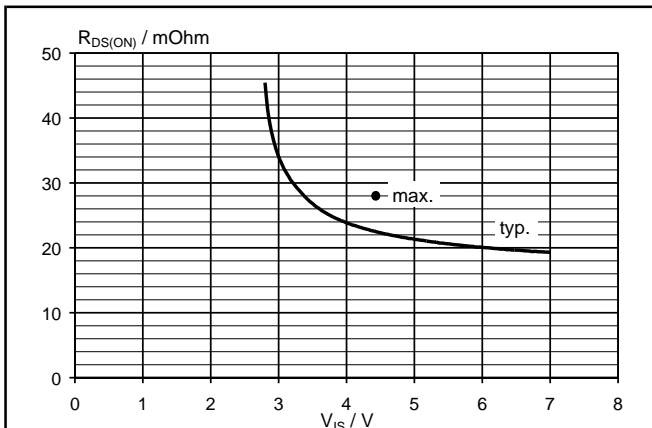

Fig. 9. Typical on-state resistance, $T_j = 25^\circ C$. $R_{DS(ON)} = f(V_{IS})$; conditions: $I_D = 10\text{ A}$; $V_{PS} = 4\text{ V}$; $t_p = 300\text{ }\mu s$

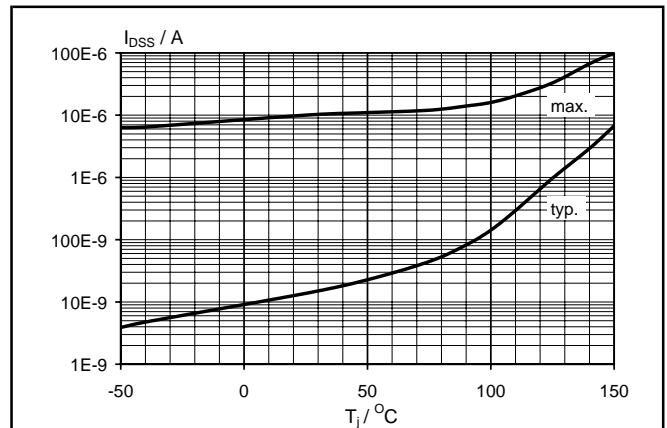

Fig. 12. Typical drain source leakage current. $I_{DSS} = f(T_j)$; conditions: $V_{DS} = 40\text{ V}$; $V_{PS} = V_{IS} = 0\text{ V}$

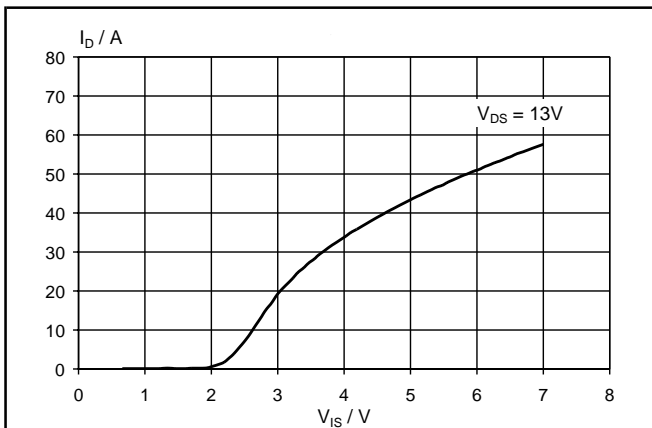

Fig. 10. Typical transfer characteristics, $T_j = 25^\circ C$. $I_D = f(V_{IS})$; conditions: $V_{PS} \geq 4\text{ V}$; $t_p = 300\text{ }\mu s$

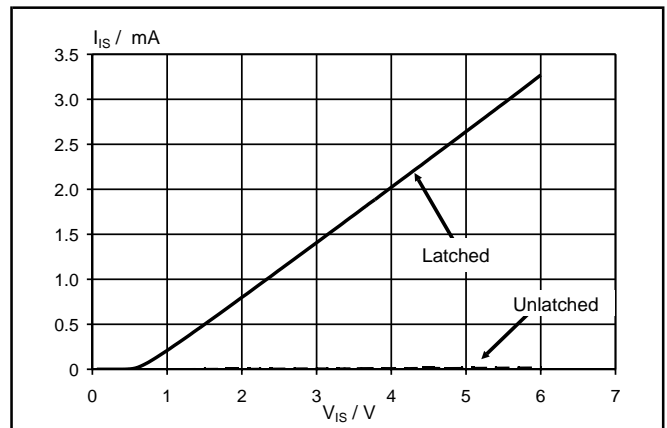

Fig. 13. Typical DC input characteristics, $T_j = 25^\circ C$. I_{IS} & $I_{ISL} = f(V_{IS})$; normal operation & protection latched

Logic level TOPFET

PIP3102-R

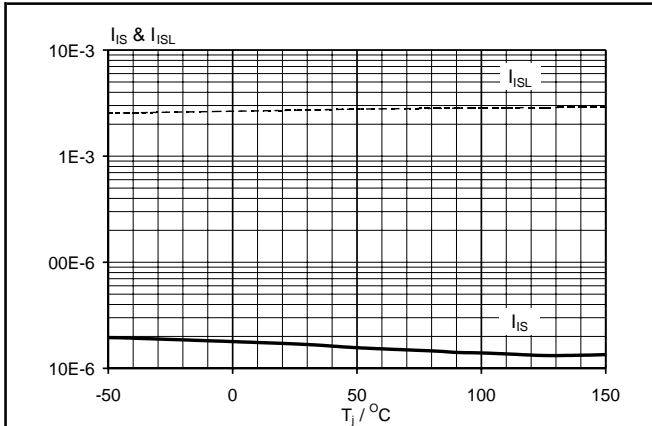

Fig. 14. Typical DC input currents. I_{IS} & $I_{ISL} = f(T_j)$; normal & latched; conditions: $V_{IS} = 5\text{ V}$; $V_{PS} = 5\text{ V}$

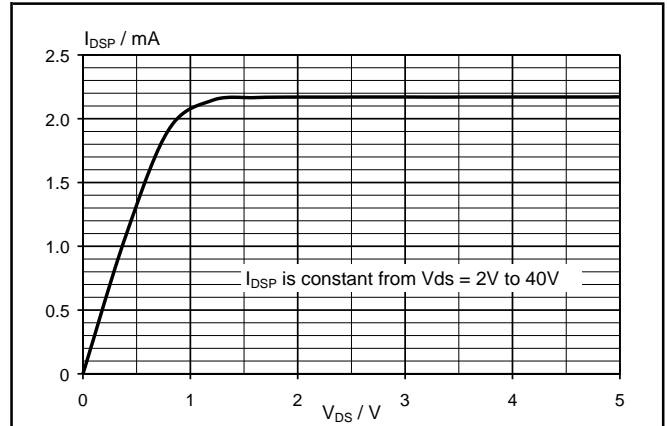

Fig. 17. Off state drain current characteristic. $I_{DSP} = f(V_{DS})$; conditions: $T_j = 25^\circ\text{C}$; $V_{PS} = 5\text{ V}$; $V_{IS} = 0\text{ V}$

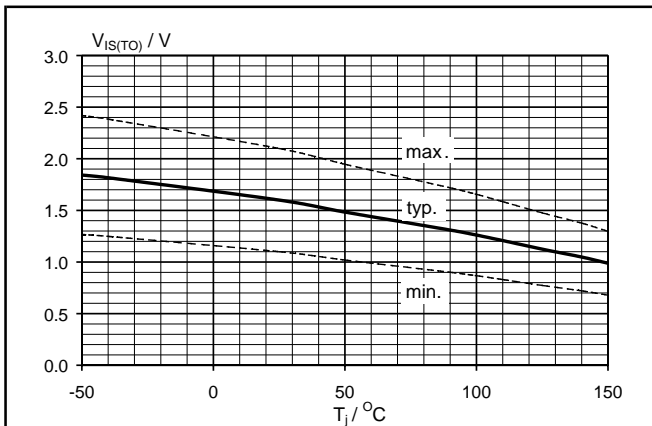

Fig. 15. Input threshold voltage. $V_{IS(TO)} = f(T_j)$; conditions: $I_D = 1\text{ mA}$; $V_{DS} = 5\text{ V}$

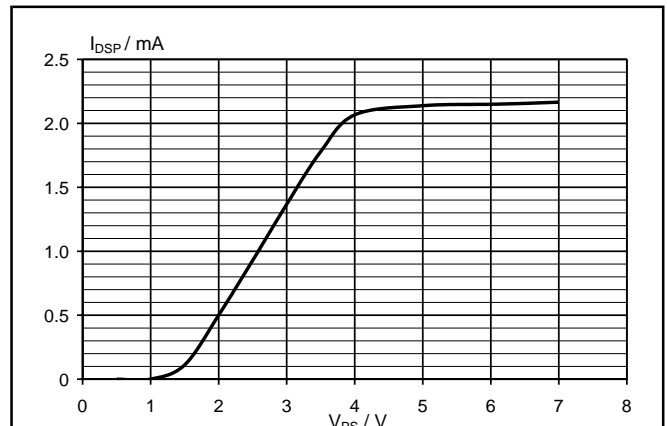

Fig. 18. Off state drain current vs protection supply. $I_{DSP} = f(V_{PS})$; $T_j = 25^\circ\text{C}$; $V_{DS} = 13\text{ V}$; $V_{IS} = 0\text{ V}$

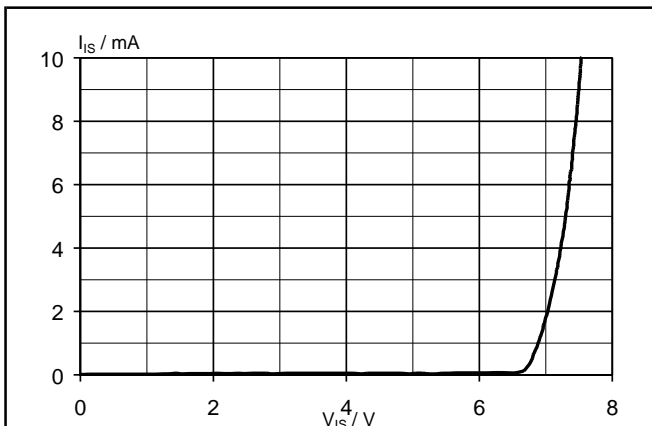

Fig. 16. Typical input clamping characteristic. $I_i = f(V_{IS})$; normal operation, $T_j = 25^\circ\text{C}$

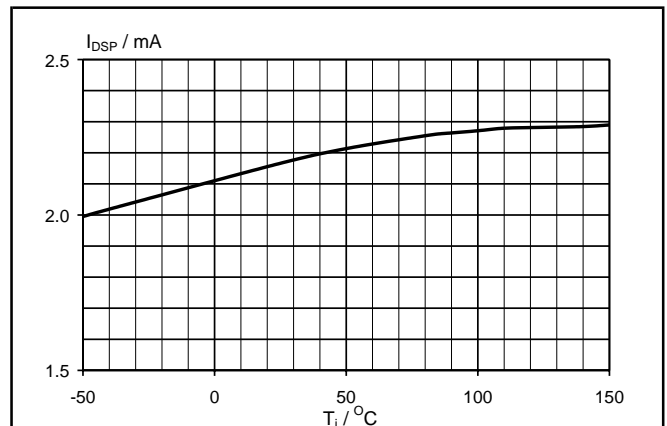
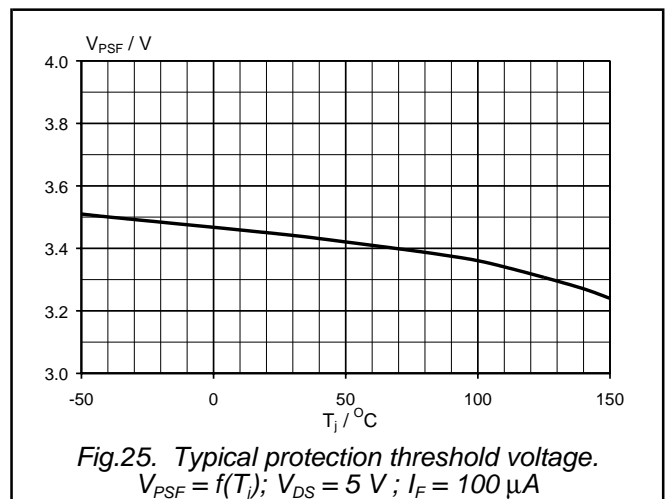
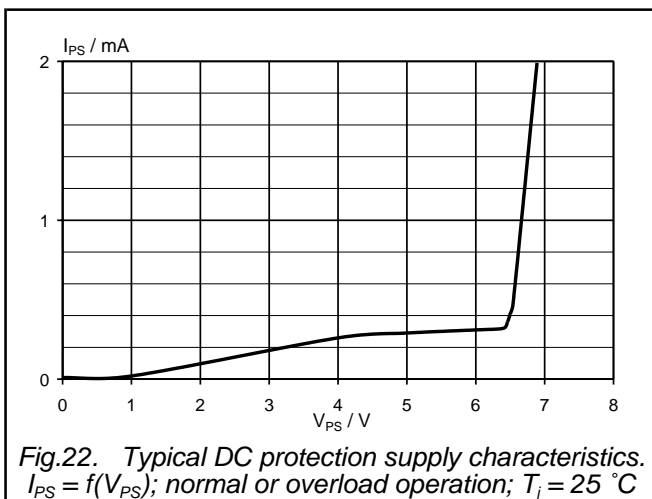
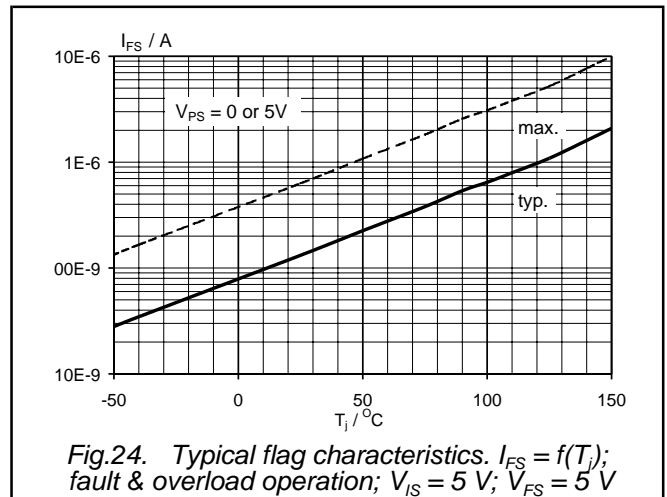
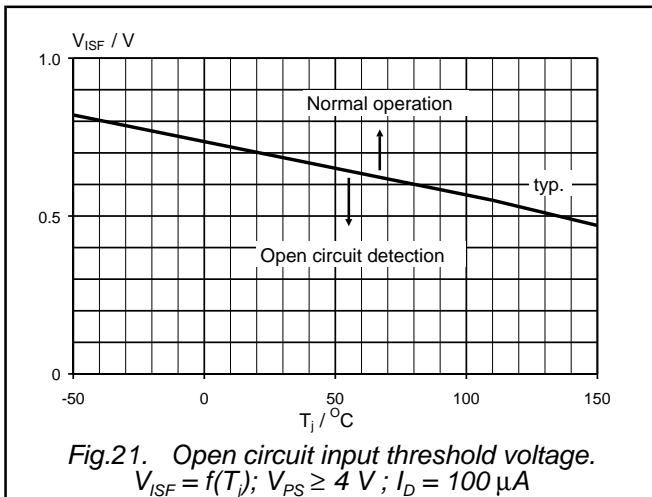
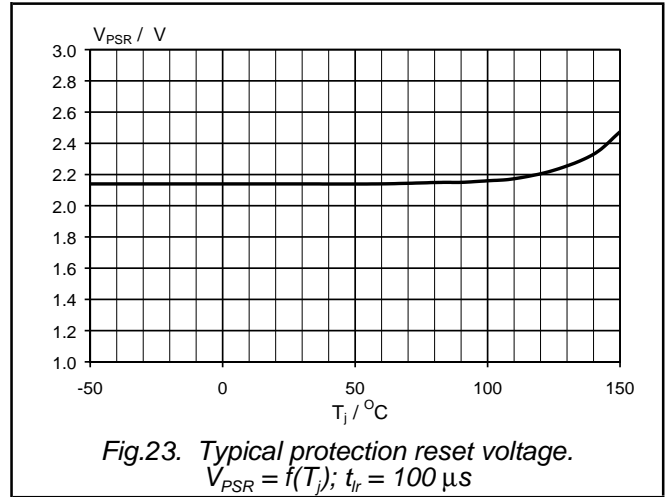
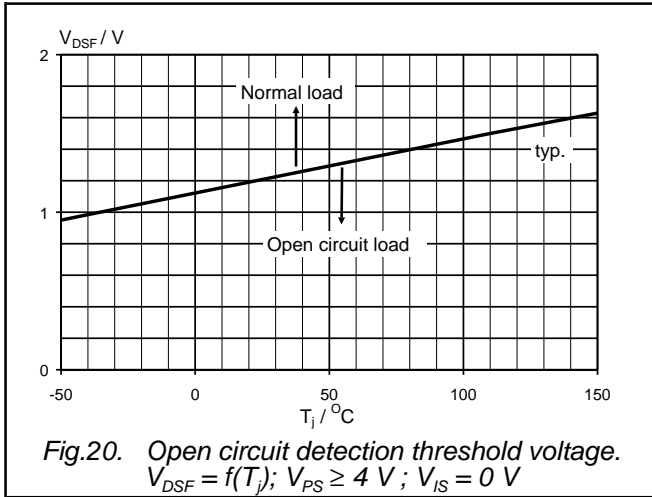

Fig. 19. Typical off state drain current $I_{DSP} = f(T_j)$; conditions: $V_{DS} = 13\text{ V}$; $V_{PS} = 5\text{ V}$; $V_{IS} = 0\text{ V}$

Logic level TOPFET

PIP3102-R



Logic level TOPFET

PIP3102-R

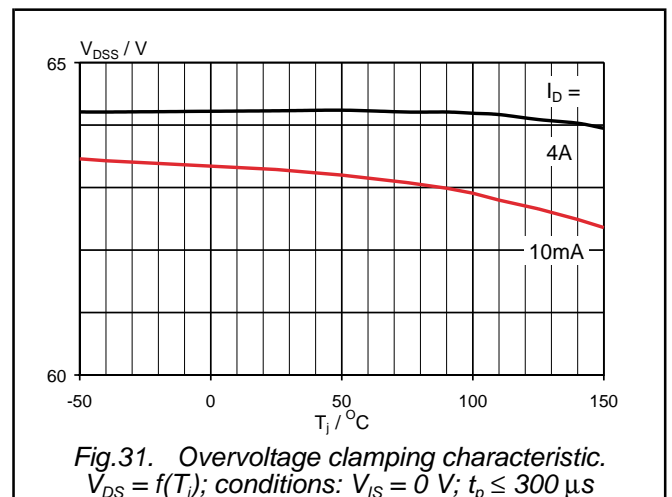
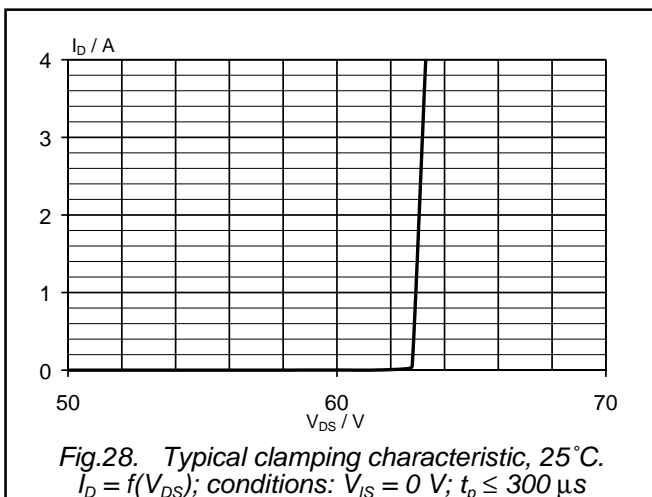
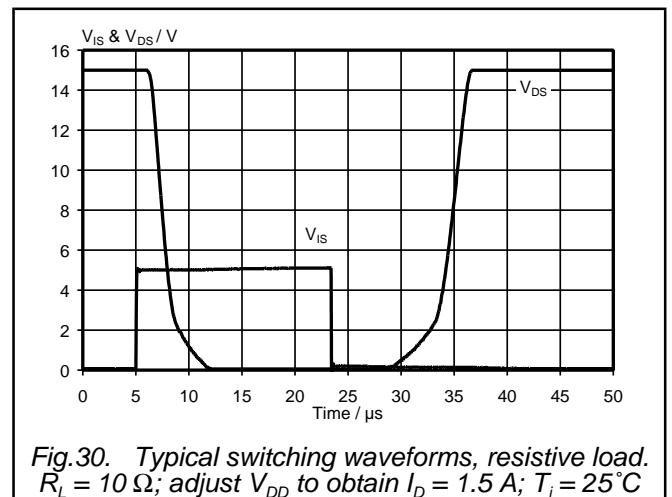
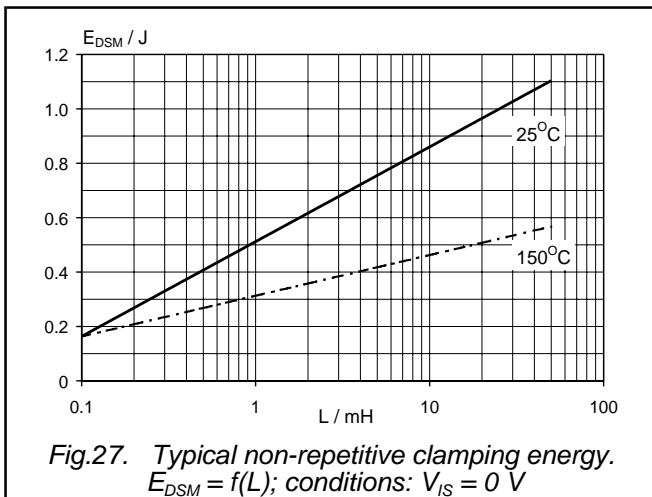
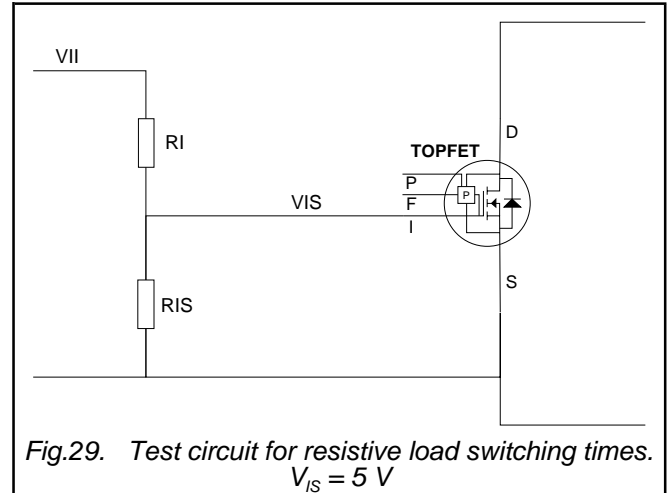
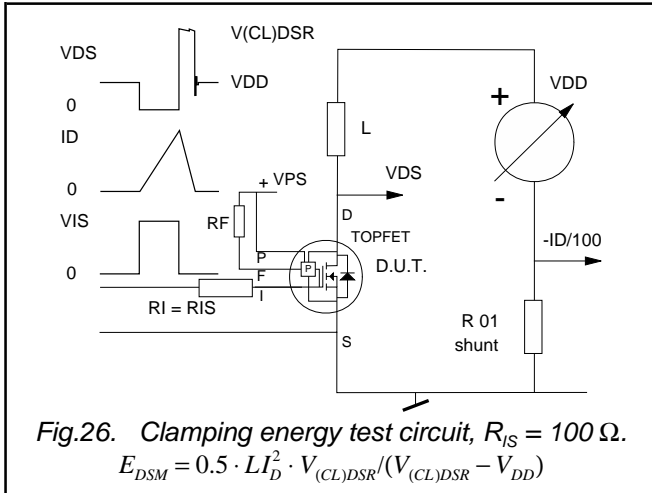

Logic level TOPFET

PIP3102-R

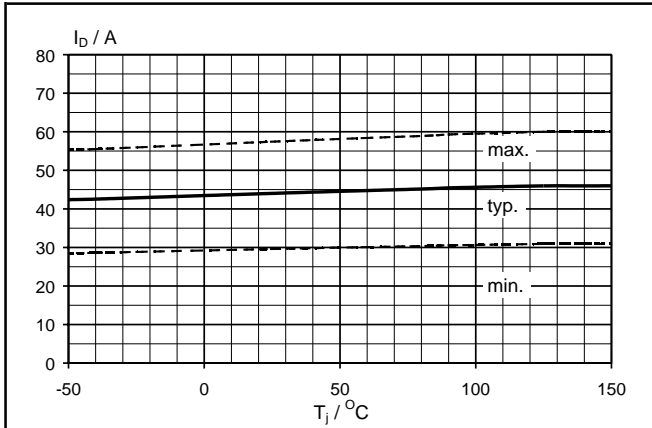

Fig.32. Typical overload current, $V_{DS} = 5\text{ V}$.
 $I_D = f(T_j)$; conditions: $V_{IS} = 5\text{ V}$; $V_{PS} = 4\text{ V}$; $t_p = 300\ \mu\text{s}$

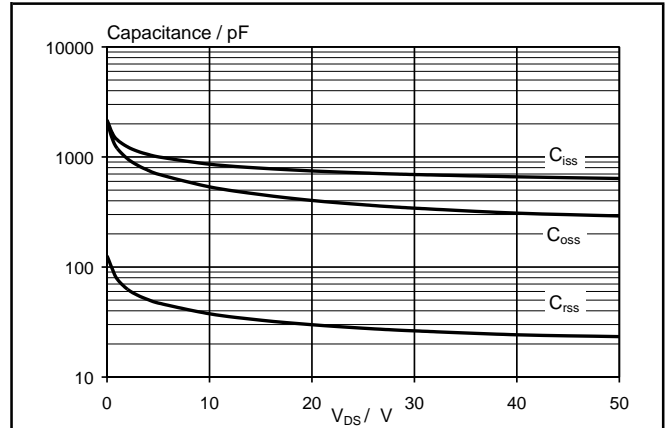

Fig.34. Typical capacitances, C_{iss} , C_{oss} , C_{rss} .
 $C = f(V_{DS})$; conditions: $V_{IS} = 0\text{ V}$; $f = 1\text{ MHz}$

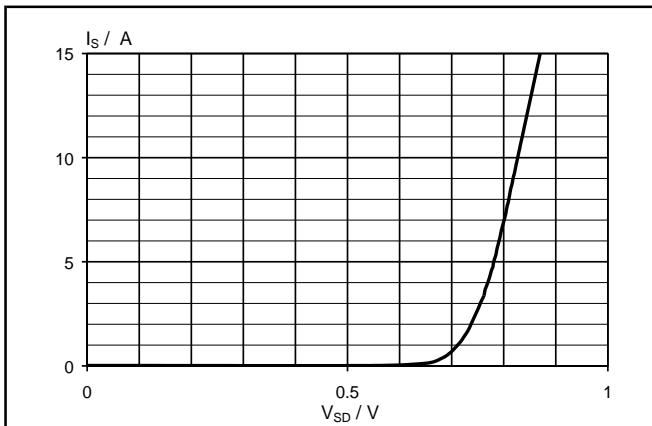

Fig.33. Typical reverse diode current, $T_j = 25\text{ }^\circ\text{C}$.
 $I_S = f(V_{SDS})$; conditions: $V_{IS} = 0\text{ V}$; $t_p = 300\ \mu\text{s}$

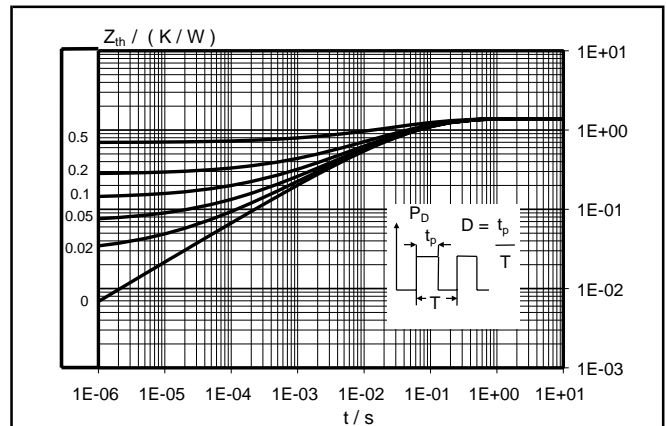

Fig.35. Transient thermal impedance.
 $Z_{th\ j-mb} = f(t)$; parameter $D = t_p/T$

Logic level TOPFET

PIP3102-R

MECHANICAL DATA

Plastic single-ended surface mounted package (Philips version of D²-PAK); 5 leads (one lead cropped)

SOT426

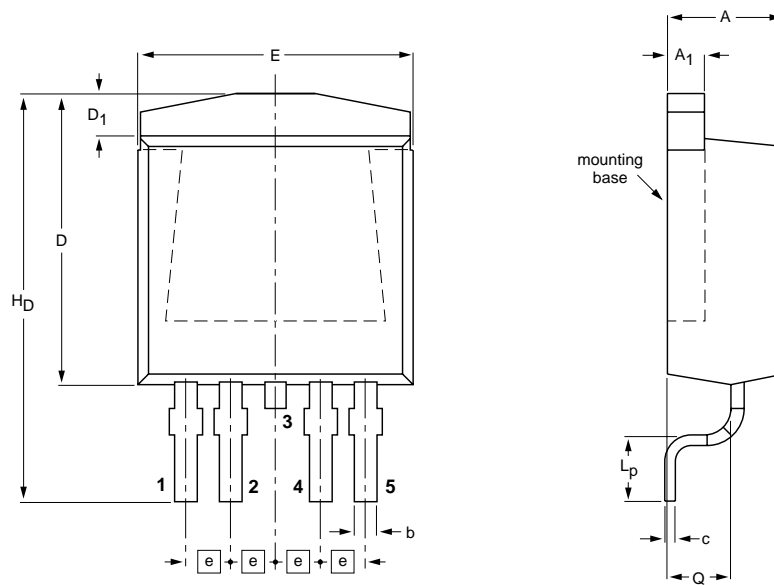

DIMENSIONS (mm are the original dimensions)

UNIT	A	A ₁	b	c	D max.	D ₁	E	e	L _p	H _D	Q
mm	4.50 4.10	1.40 1.27	0.85 0.60	0.64 0.46	11	1.60 1.20	10.30 9.70	1.70	2.90 2.10	15.80 14.80	2.60 2.20

OUTLINE VERSION	REFERENCES				EUROPEAN PROJECTION	ISSUE DATE
	IEC	JEDEC	EIAJ			
SOT426						98-12-14 99-06-25

Fig.36. SOT426 surface mounting package¹, centre pin connected to mounting base.

¹ Epoxy meets UL94 V0 at 1/8". Net mass: 1.5 g.

For soldering guidelines and SMD footprint design, please refer to Data Handbook SC18.

Logic level TOPFET

PIP3102-R

DEFINITIONS

DATA SHEET STATUS		
DATA SHEET STATUS¹	PRODUCT STATUS²	DEFINITIONS
Objective data	Development	This data sheet contains data from the objective specification for product development. Philips Semiconductors reserves the right to change the specification in any manner without notice
Preliminary data	Qualification	This data sheet contains data from the preliminary specification. Supplementary data will be published at a later date. Philips Semiconductors reserves the right to change the specification without notice, in order to improve the design and supply the best possible product
Product data	Production	This data sheet contains data from the product specification. Philips Semiconductors reserves the right to make changes at any time in order to improve the design, manufacturing and supply. Changes will be communicated according to the Customer Product/Process Change Notification (CPCN) procedure SNW-SQ-650A
Limiting values		
Limiting values are given in accordance with the Absolute Maximum Rating System (IEC 134). Stress above one or more of the limiting values may cause permanent damage to the device. These are stress ratings only and operation of the device at these or at any other conditions above those given in the Characteristics sections of this specification is not implied. Exposure to limiting values for extended periods may affect device reliability.		
Application information		
Where application information is given, it is advisory and does not form part of the specification.		
© Philips Electronics N.V. 2002		
All rights are reserved. Reproduction in whole or in part is prohibited without the prior written consent of the copyright owner.		
The information presented in this document does not form part of any quotation or contract, it is believed to be accurate and reliable and may be changed without notice. No liability will be accepted by the publisher for any consequence of its use. Publication thereof does not convey nor imply any license under patent or other industrial or intellectual property rights.		

LIFE SUPPORT APPLICATIONS

These products are not designed for use in life support appliances, devices or systems where malfunction of these products can be reasonably expected to result in personal injury. Philips customers using or selling these products for use in such applications do so at their own risk and agree to fully indemnify Philips for any damages resulting from such improper use or sale.

¹ Please consult the most recently issued datasheet before initiating or completing a design.

² The product status of the device(s) described in this datasheet may have changed since this datasheet was published. The latest information is available on the Internet at URL <http://www.semiconductors.philips.com>.