

**LA6538T**

Single-Phase Full-Wave Fan Motor Driver

Overview

The LA6538T is optimal for use as a fan motor driver in equipment, such as notebook personal computers and electronic game units, that requires miniaturization and low noise levels. This device achieves highly efficient single-phase bipolar fan motor drive by providing a low saturation voltage BTL output.

Functions and Features

- BTL output single-phase full-wave linear drive (gain resistance: 180 to 500 k Ω , 360 \times)
 - Since this device generates no switching noise, it is optimal for fan drive in audio equipment, electronic games, and notebook personal computers.
- Supports low-voltage operation and features a wide usable voltage range ($V_{CC} = 2.5$ to 9.5 V).
- Low saturation voltage output (Upper side + lower side saturation voltage: $V_{O\text{sat}}(\text{total}) = 0.2$ V (typ), $I_O = 100$ mA)
 - This device achieves a high coil efficiency for low current drain, and generates minimal heat in the IC itself.
- Constant-voltage Hall bias output.
 - The Hall element is regulated at 2.1 V, and the device provides a stable Hall output with excellent temperature characteristics.
- FG output
 - The LA6538T provides a speed detection output (an open-collector output).
- Built-in thermal protection circuit
 - This circuit limits the drive current to prevent damage to or destruction of the IC when the IC chip temperature exceeds 180 $^{\circ}\text{C}$ due to excessive output current caused by load shorting or other problem.

- Ultraminiature package (MSOP-8: 3.0 \times 4.9 \times 0.93 mm³)
 - Allows the circuit board to be miniaturized and a large heat sink to be used.

Reference materials:

T package (MSOP-8) series fan motor drivers

LB1964T: 3 and 5 V operation, low saturation voltage switching single-phase bipolar drive, FG output

LB11963T: 5 and 12 V operation, switching single-phase bipolar drive, restart circuit, lock detection, 1/2 FG output

LB11964T: 5 and 12 V operation, switching single-phase bipolar drive, restart circuit, lock detection, FG output

Package Dimensions

unit: mm

3245-MSOP8

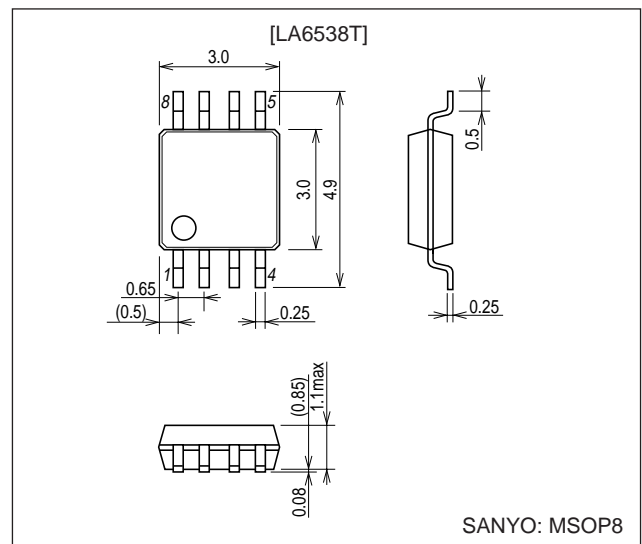

■ Any and all SANYO products described or contained herein do not have specifications that can handle applications that require extremely high levels of reliability, such as life-support systems, aircraft's control systems, or other applications whose failure can be reasonably expected to result in serious physical and/or material damage. Consult with your SANYO representative nearest you before using any SANYO products described or contained herein in such applications.

■ SANYO assumes no responsibility for equipment failures that result from using products at values that exceed, even momentarily, rated values (such as maximum ratings, operating condition ranges, or other parameters) listed in products specifications of any and all SANYO products described or contained herein.

SANYO Electric Co.,Ltd. Semiconductor Company

TOKYO OFFICE Tokyo Bldg., 1-10, 1 Chome, Ueno, Taito-ku, TOKYO, 110-8534 JAPAN

LA6538T

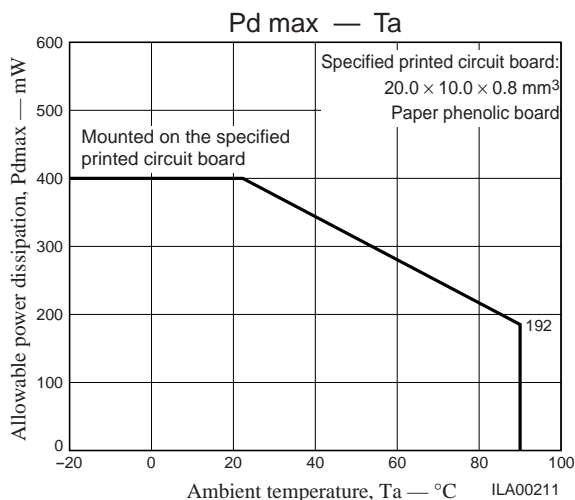

Specifications

Maximum Ratings at Ta = 25°C

Parameter	Symbol	Conditions	Ratings	Unit
Maximum supply voltage	V _{CC} max		10	V
Allowable power dissipation	Pd max	Mounted on the specified printed circuit board*	400	mW
OUT pin output current	I _{OUT} max		0.3	A
OUT pin output voltage handling	V _{OUT} max		9.5	V
FG output voltage handling	V _{FG} max		10	V
FG output current	I _{FG} max		5	mA
Operating temperature	T _{opr}		-20 to +90	°C
Storage temperature	T _{stg}		-55 to +150	°C

Note: * Specified printed circuit board: 20.0 × 10.0 × 0.8 mm³ paper phenolic board, wiring density: 20%.

Recommended Operating Conditions at Ta = 25°C

Parameter	Symbol	Conditions	Ratings	Unit
Supply voltage	V _{CC}		2.5 to 9.5	V
Hall input common-mode input voltage range	V _{ICM}		0.9 to V _{CC} - 1	V

Electrical Characteristics at Ta = 25°C, V_{CC} = 5 V

Parameter	Symbol	Conditions	Ratings			Unit
			min	typ	max	
Circuit current	I _{CC}	IN ⁻ = 2.6 V, IN ⁺ = 2.4 V, R _L = ∞		10	15	mA
OUT pin output low-level voltage	V _{OL}	I _O = 100 mA		0.1	0.2	V
OUT pin output high-level voltage	V _{OH}	I _O = 100 mA		0.1	0.2	V
Hall bias voltage	V _{HB}	RH = 360 Ω + 91 Ω	1.9	2.1	2.3	V
Hall amplifier gain	VG		47	50	53	dB
Hall amplifier input resistance	V _{INR}		400	500	620	Ω
FG output low-level voltage	V _{FG}	I _{FG} = 3 mA		0.2	0.3	V
FG output leakage current	I _{FGL}	V _{FG} = 7 V			30	μA
Thermal protection circuit	T-TSD	Design guarantee*	150	180	200	°C

Note: * Design guarantee: Indicates a design target value. These parameters are not tested in the independent IC.

Truth Table

IN ⁻	IN ⁺	OUT1	OUT2	FG	Mode
H	L	H	L	L	Motor operating
L	H	L	H	off	
—	—	off	off	—	Thermal protection activated

LA6538T

Pin Assignment

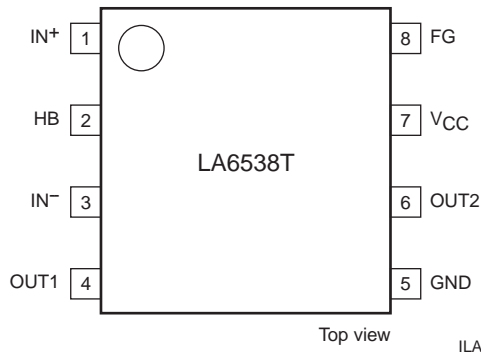

ILA00206

Sample Application Circuit

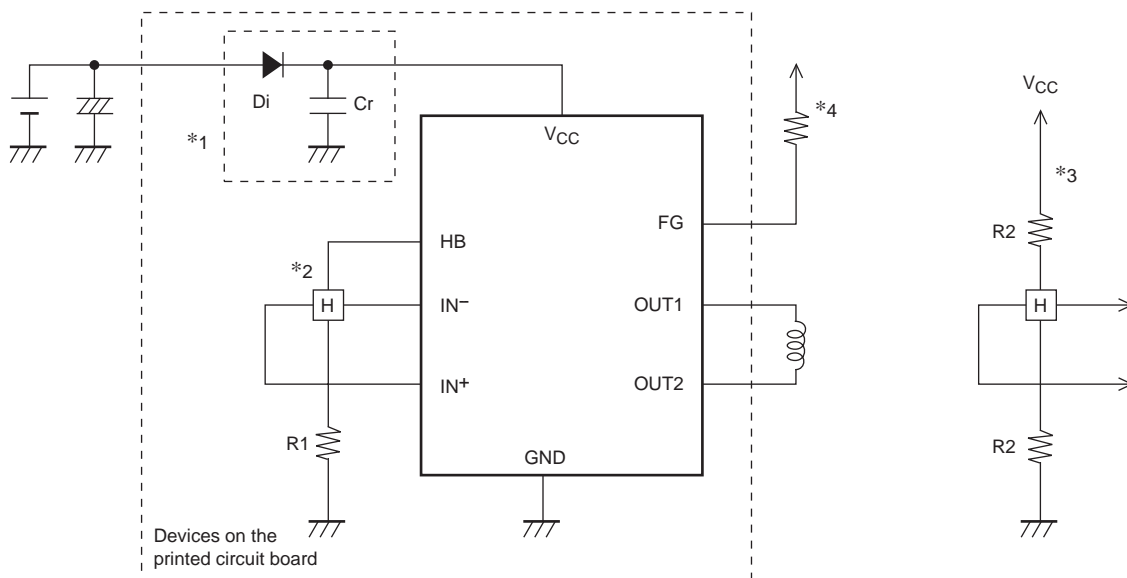

ILA00207

ILA00208

- Notes:
1. When the diode Di is used to prevent device destruction from reverse connection, the capacitor Cr must be inserted to assure a path for regenerative currents. Similarly, if there are no nearby capacitors on the fan power supply line, the capacitor Cr is also required to increase reliability.
 2. The Hall element is biased at a constant voltage of approximately 2.1 V from the HB pin. Thus the LA6538T provides a stable Hall output with excellent temperature characteristics. The resistor R1 adjusts the Hall output amplitude. The LA6538T implements linear drive by amplifying the Hall output and applying voltage control to the motor coils. Startup characteristics and efficiency are improved by using a higher Hall device output. However, the motor can be made to operate more quietly by adjusting the Hall device.
 3. If the Hall bias is taken from V_{CC} , bias the Hall device at $1/2 V_{CC}$ as shown in the figure.
 4. This pin must be left open if unused.

Block Diagram

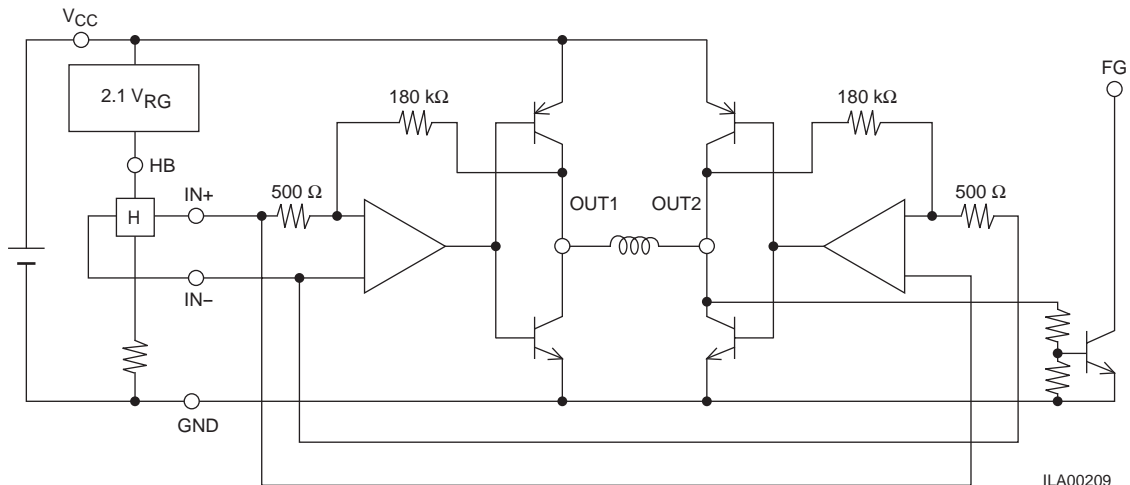

ILA00209

Timing Chart

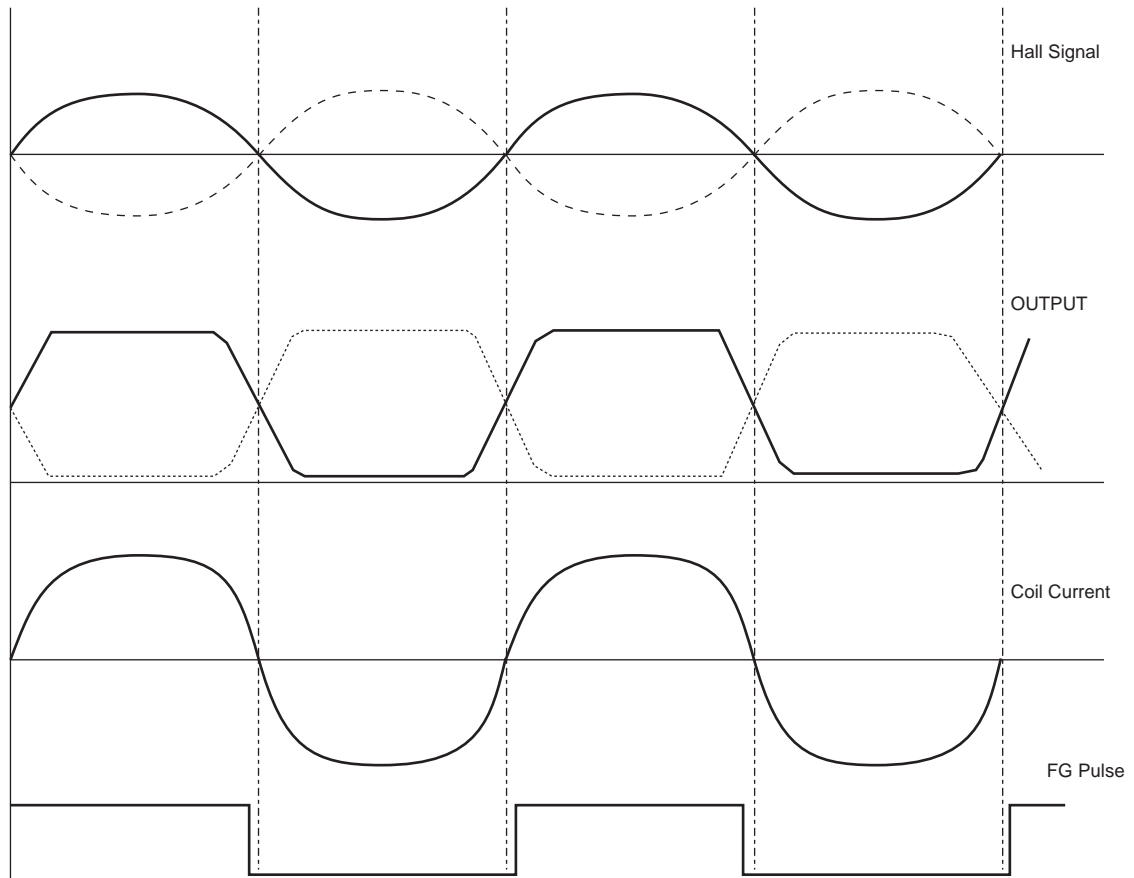

ILA00210

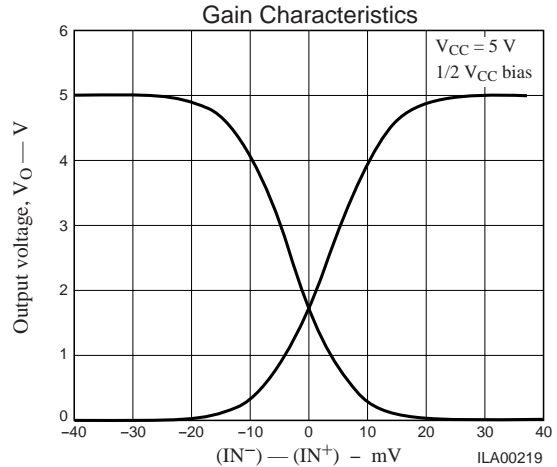
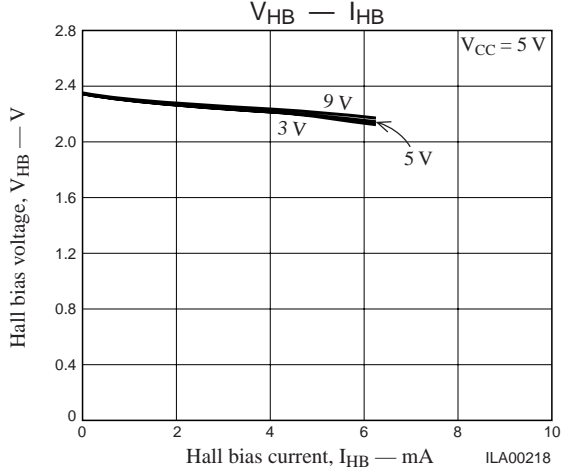
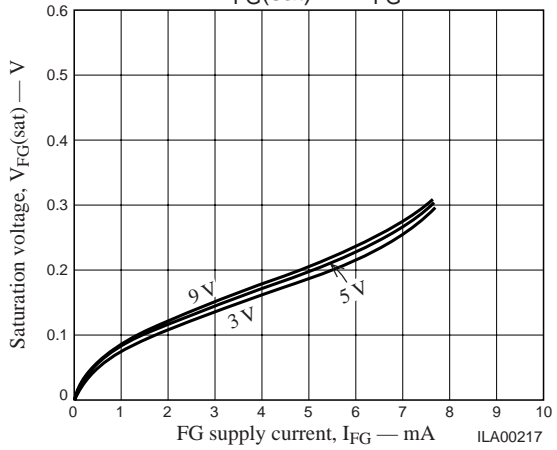
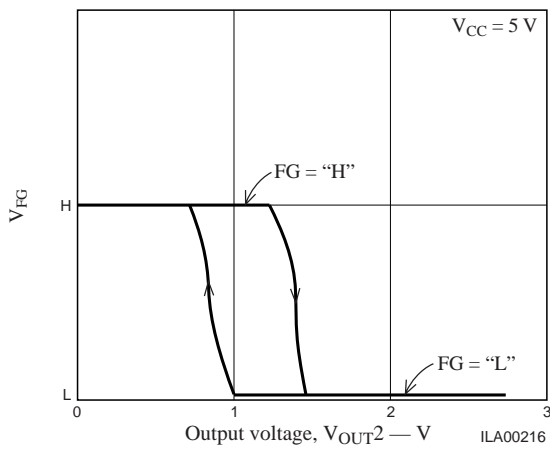
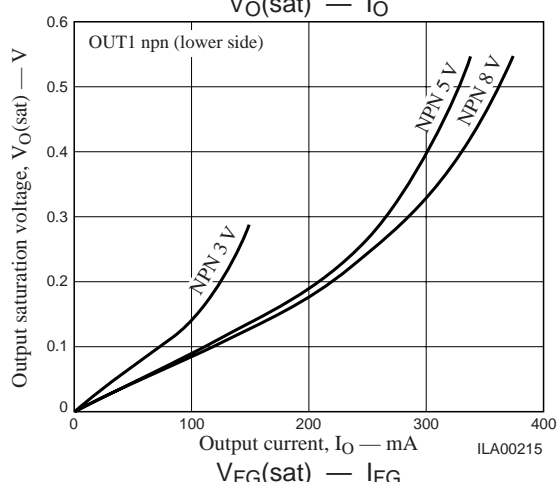
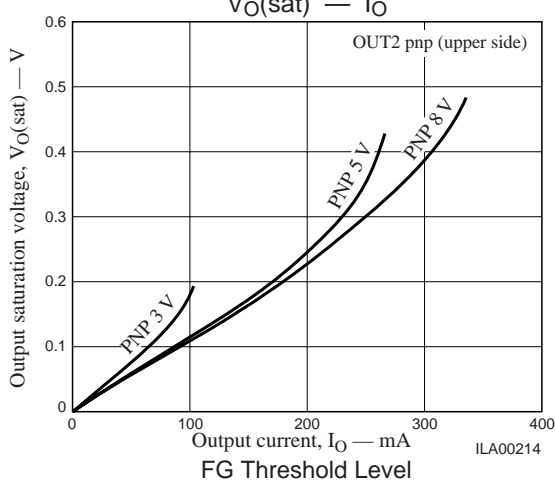
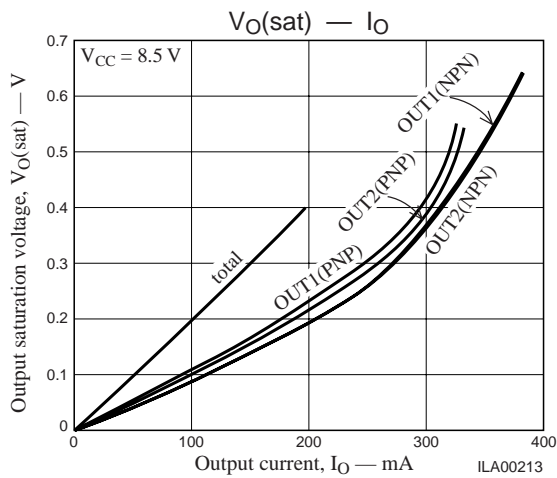
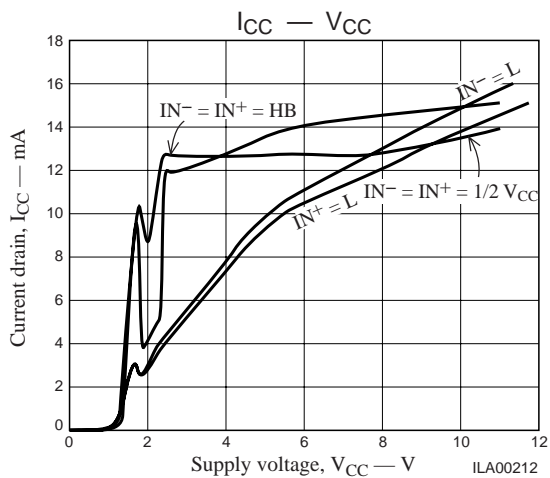

- Specifications of any and all SANYO products described or contained herein stipulate the performance, characteristics, and functions of the described products in the independent state, and are not guarantees of the performance, characteristics, and functions of the described products as mounted in the customer's products or equipment. To verify symptoms and states that cannot be evaluated in an independent device, the customer should always evaluate and test devices mounted in the customer's products or equipment.
- SANYO Electric Co., Ltd. strives to supply high-quality high-reliability products. However, any and all semiconductor products fail with some probability. It is possible that these probabilistic failures could give rise to accidents or events that could endanger human lives, that could give rise to smoke or fire, or that could cause damage to other property. When designing equipment, adopt safety measures so that these kinds of accidents or events cannot occur. Such measures include but are not limited to protective circuits and error prevention circuits for safe design, redundant design, and structural design.
- In the event that any or all SANYO products (including technical data, services) described or contained herein are controlled under any of applicable local export control laws and regulations, such products must not be exported without obtaining the export license from the authorities concerned in accordance with the above law.
- No part of this publication may be reproduced or transmitted in any form or by any means, electronic or mechanical, including photocopying and recording, or any information storage or retrieval system, or otherwise, without the prior written permission of SANYO Electric Co., Ltd.
- Any and all information described or contained herein are subject to change without notice due to product/technology improvement, etc. When designing equipment, refer to the "Delivery Specification" for the SANYO product that you intend to use.
- Information (including circuit diagrams and circuit parameters) herein is for example only; it is not guaranteed for volume production. SANYO believes information herein is accurate and reliable, but no guarantees are made or implied regarding its use or any infringements of intellectual property rights or other rights of third parties.

This catalog provides information as of August, 2000. Specifications and information herein are subject to change without notice.