



LA1225M

FM IF Detector IC

Functions

- IF amplifier
- Quadrature detector
- Signal meter
- SD
- IF buffer

Features

- Low-voltage operation (1.8 V or higher)
- Supports electronic tuning systems (provides built-in SD output and IF count output functions)
- FM detector circuit accepts an even wider input frequency range. (Supports the use of an external phase capacitor.)
- Miniature package: MFP-10S

Package Dimensions

unit: mm

3086A-MFP10S

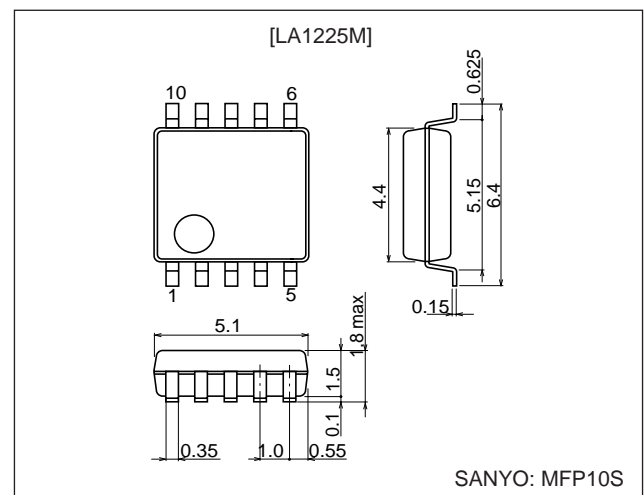

Specifications

Maximum Ratings at Ta = 25°C

Parameter	Symbol	Conditions	Ratings	Unit
Maximum supply voltage	V _{CC} max		9.0	V
Allowable power dissipation	Pd max	Ta ≤ 80°C	100	mW
Operating temperature	T _{opr}		-20 to +80	°C
Storage temperature	T _{stg}		-55 to +150	°C

Operating Conditions at Ta = 25°C

Parameter	Symbol	Conditions	Ratings	Unit
Recommended supply voltage	V _{CC}		3.0	V
Operating supply voltage range	V _{CC} op		1.8 to 8.0	V

■ Any and all SANYO products described or contained herein do not have specifications that can handle applications that require extremely high levels of reliability, such as life-support systems, aircraft's control systems, or other applications whose failure can be reasonably expected to result in serious physical and/or material damage. Consult with your SANYO representative nearest you before using any SANYO products described or contained herein in such applications.

■ SANYO assumes no responsibility for equipment failures that result from using products at values that exceed, even momentarily, rated values (such as maximum ratings, operating condition ranges, or other parameters) listed in products specifications of any and all SANYO products described or contained herein.

SANYO Electric Co.,Ltd. Semiconductor Company

TOKYO OFFICE Tokyo Bldg., 1-10, 1 Chome, Ueno, Taito-ku, TOKYO, 110-8534 JAPAN

LA1225M

Operating Characteristics at $T_a = 25^\circ\text{C}$, $V_{CC} = 3.0\text{ V}$, $f_c = 10.7\text{ MHz}$

Parameter	Symbol	Conditions	Ratings			Unit
			min	typ	max	
Current drain	I_{CCO}	No input	3.0	4.0	5.0	mA
Demodulator output	V_O	100 dB μ , 100% mod., $f_m = 1\text{ kHz}$	70	150	220	mV
Total harmonic distortion	THD	100 dB μ , 100% mod., $f_m = 1\text{ kHz}$		0.5	0.8	%
Signal-to-noise ratio	S/N	100 dB μ , 100% mod., $f_m = 1\text{ kHz}$	65	73		dB
3 dB sensitivity	-3 dBLS	100 dB μ , 100% mod., $f_m = 1\text{ kHz}$ output reference, when the input is -3 dB	19	28	37	dB μ
SD sensitivity	SDON	0% mod.	35	50	65	dB μ
IF counter buffer output	V_{IFBuff}	100 dB μ	90	130	170	mV

Pin Functions and No-Signal Voltage at $V_{CC} = 3.0\text{ V}$

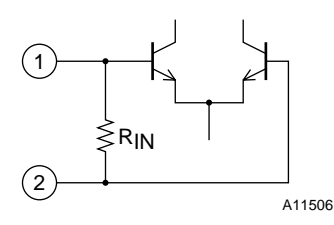
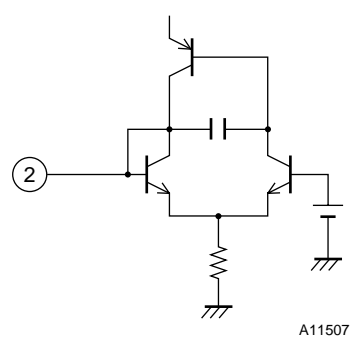
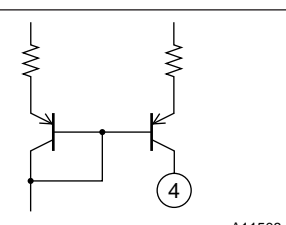
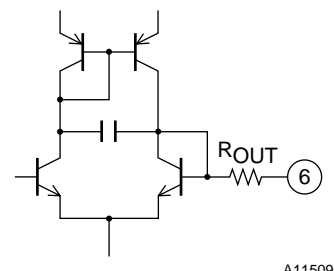
Pin No.	Function	Notes	No-signal voltage (V)	Equivalent circuit
1	IF input	Input impedance $R_{IN} = 330\ \Omega$	1.2	 <p style="text-align: right;">A11506</p>
2	Reg	$V_{reg} = 1.2\text{ V}$	1.2	 <p style="text-align: right;">A11507</p>
3	GND		0	
4	S-meter output	Open collector output The SD sensitivity can be adjusted with an external resistor connected to this pin.	0.1	 <p style="text-align: right;">A11508</p>
5	V_{CC}		3.0	
6	Demodulated output	Output impedance $R_{OUT} = 3\text{ k}\Omega$	1.5	 <p style="text-align: right;">A11509</p>

Continued on next page.

LA1225M

Continued from preceding page.

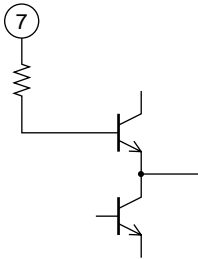
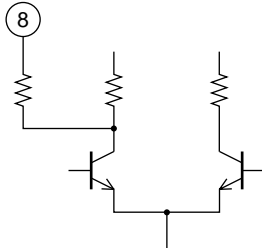
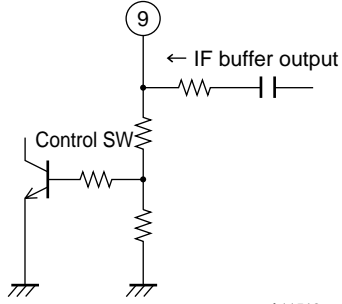
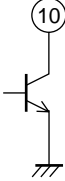
Pin No.	Function	Notes	No-signal voltage (V)	Equivalent circuit
7	DET	The detector coil is inserted between pin 7 and pin 5 (V_{CC}).	3.0	 <p style="text-align: right;">A11510</p>
8	Limiter amplifier output	Pin 8 and pin 7 (DET) are connected through a capacitor.	2.8	 <p style="text-align: right;">A11511</p>
9	IF buffer (Also used for control SW)	The IF buffer output is turned on when the voltage applied to the pin is the recommended 1.5 V or higher.	0	 <p style="text-align: right;">A11512</p>
10	SD	This is an active-low output. This is an open-collector output and can directly drive an LED. ($I_{Cmax} = 20 \text{ mA}$)	1.6	 <p style="text-align: right;">A11513</p>

Block Diagram

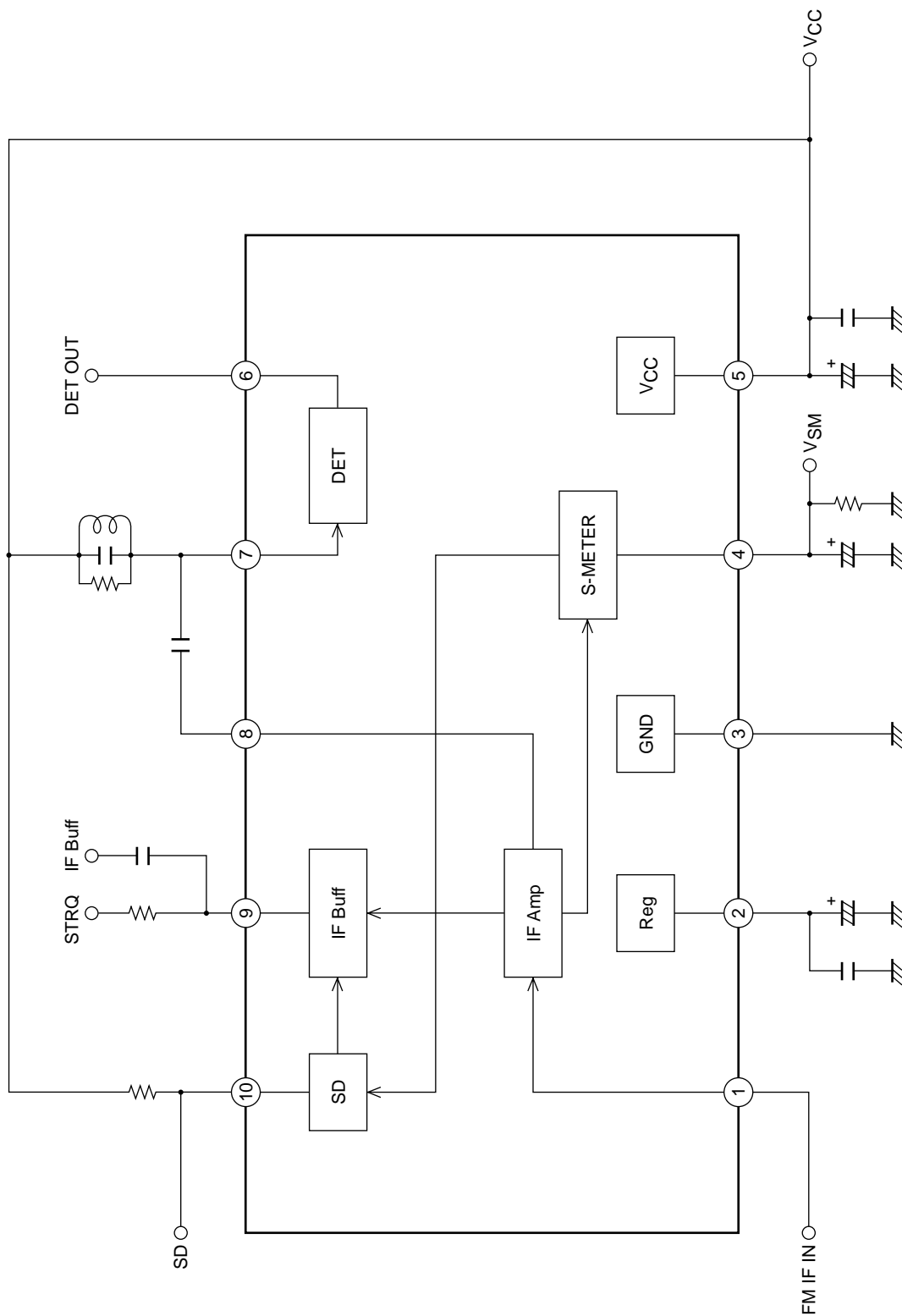

A11514

Sample Application Circuit

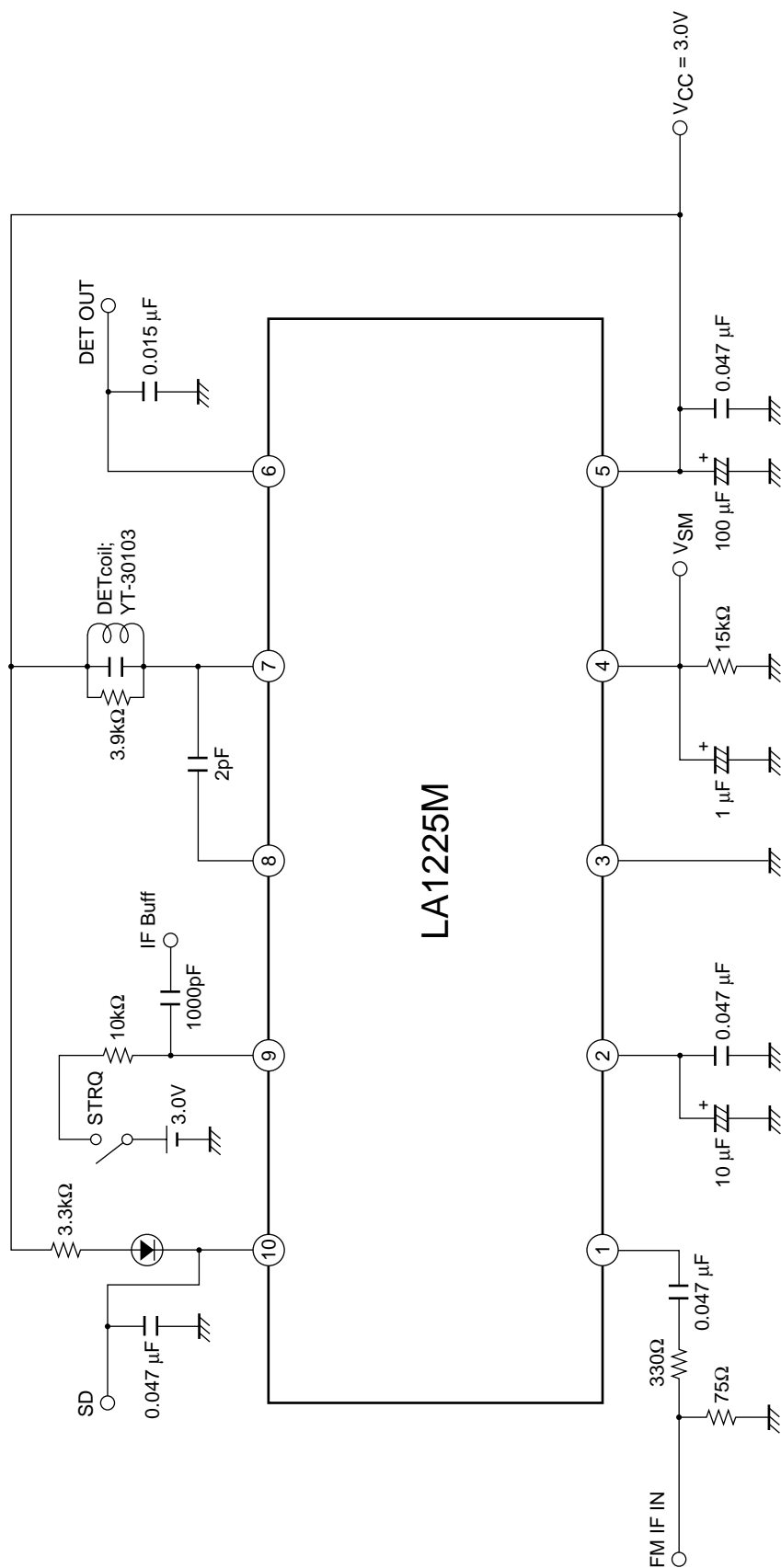

A11515

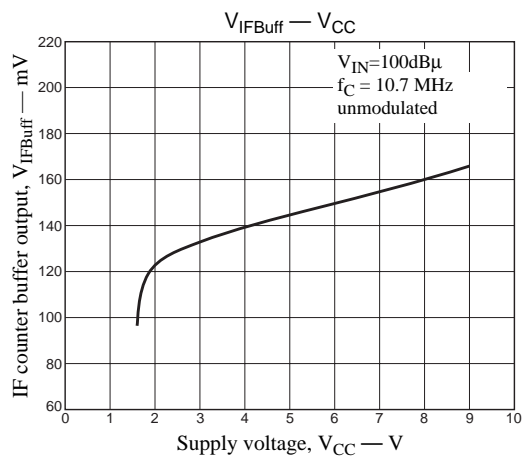
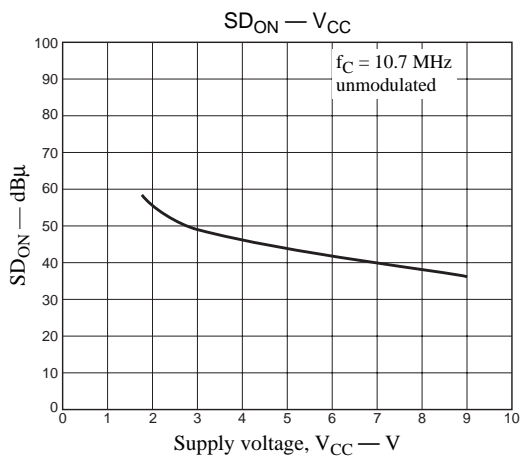
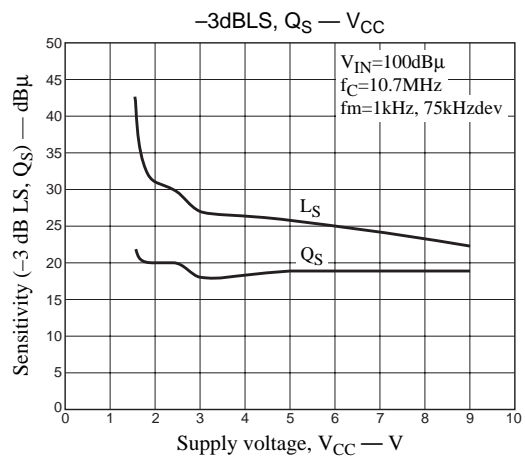
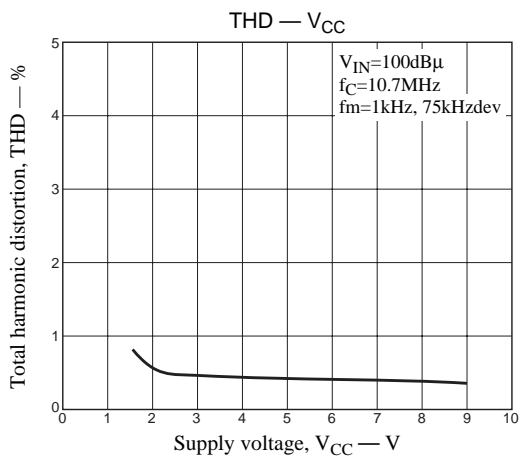
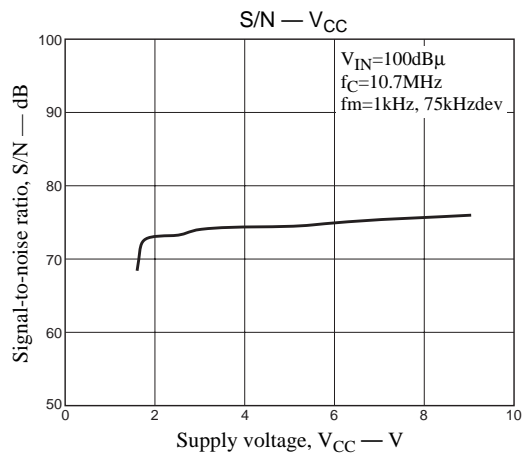
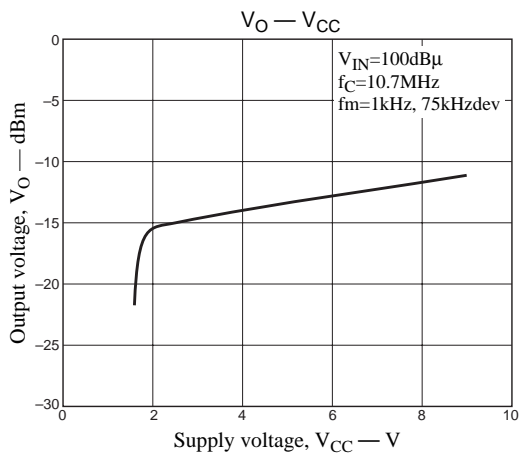
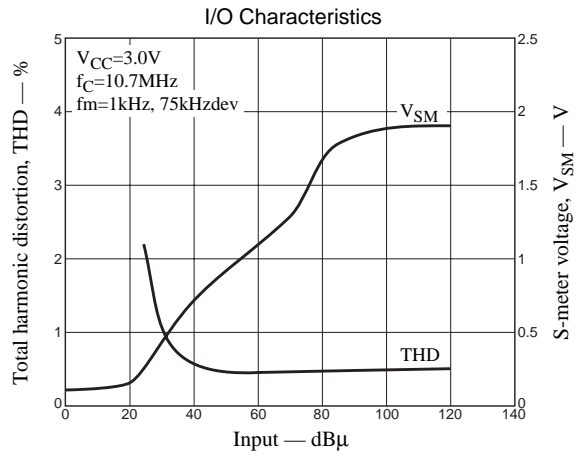
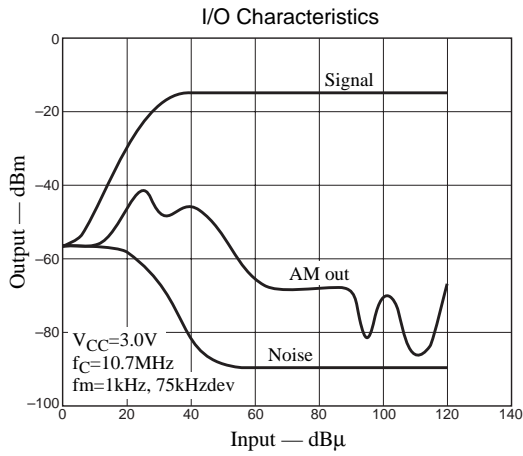

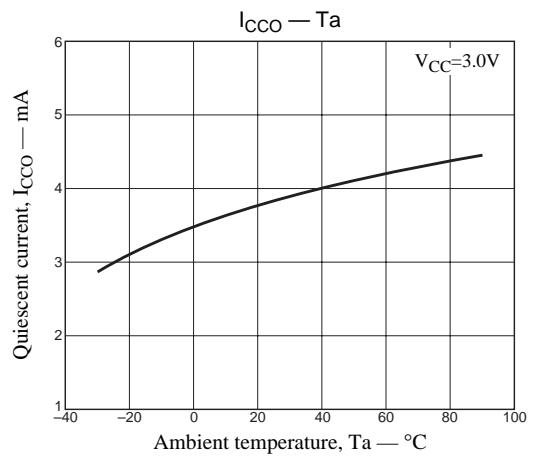
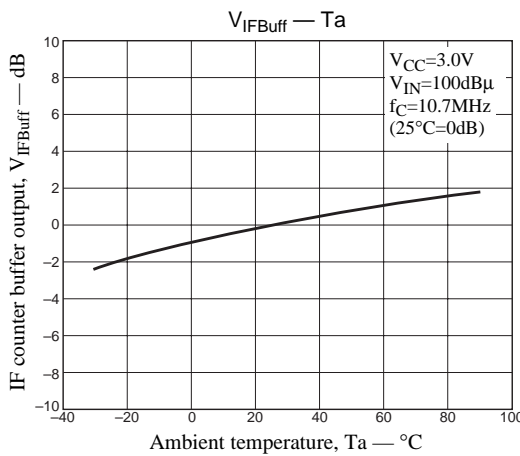
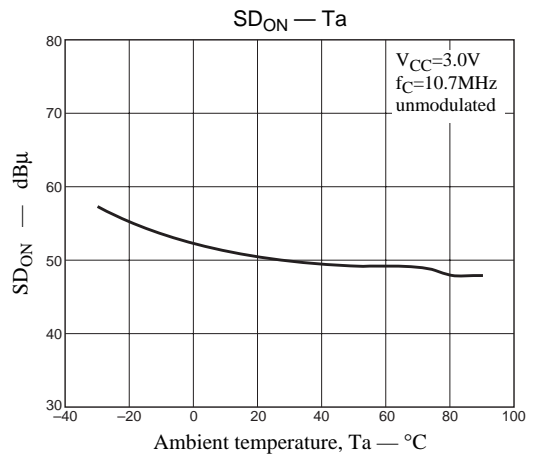
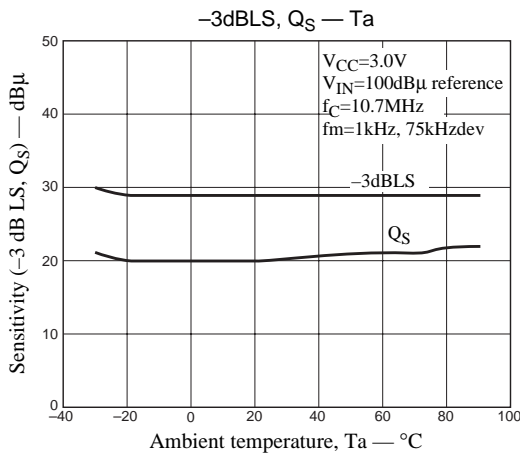
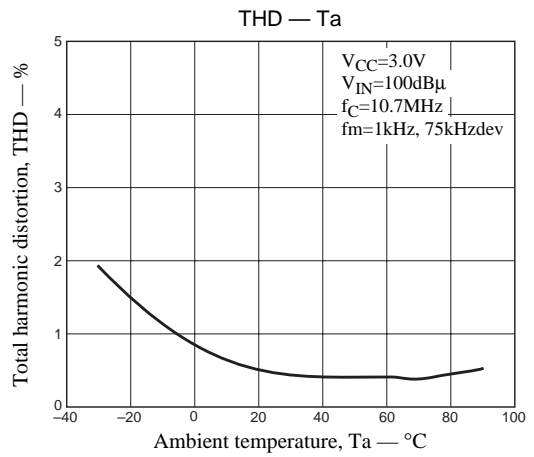
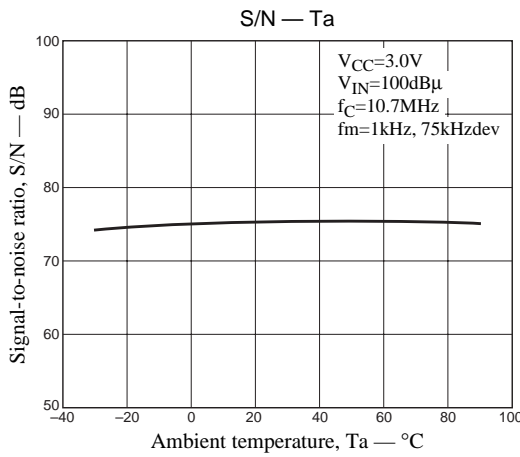
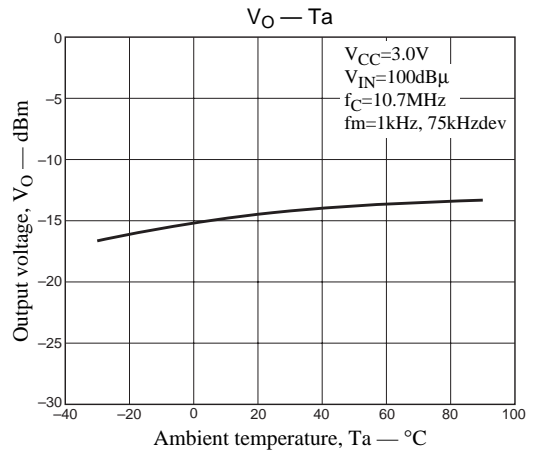
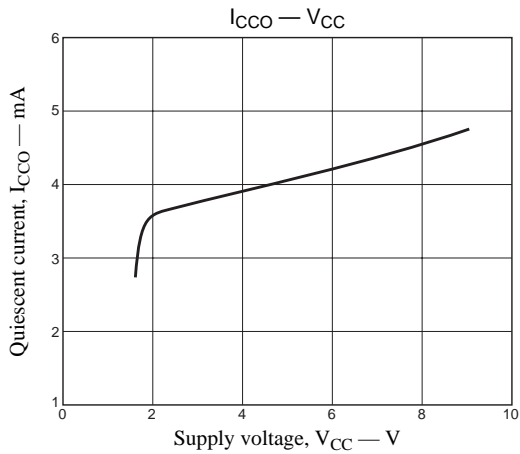

- Specifications of any and all SANYO products described or contained herein stipulate the performance, characteristics, and functions of the described products in the independent state, and are not guarantees of the performance, characteristics, and functions of the described products as mounted in the customer's products or equipment. To verify symptoms and states that cannot be evaluated in an independent device, the customer should always evaluate and test devices mounted in the customer's products or equipment.
- SANYO Electric Co., Ltd. strives to supply high-quality high-reliability products. However, any and all semiconductor products fail with some probability. It is possible that these probabilistic failures could give rise to accidents or events that could endanger human lives, that could give rise to smoke or fire, or that could cause damage to other property. When designing equipment, adopt safety measures so that these kinds of accidents or events cannot occur. Such measures include but are not limited to protective circuits and error prevention circuits for safe design, redundant design, and structural design.
- In the event that any or all SANYO products (including technical data, services) described or contained herein are controlled under any of applicable local export control laws and regulations, such products must not be exported without obtaining the export license from the authorities concerned in accordance with the above law.
- No part of this publication may be reproduced or transmitted in any form or by any means, electronic or mechanical, including photocopying and recording, or any information storage or retrieval system, or otherwise, without the prior written permission of SANYO Electric Co., Ltd.
- Any and all information described or contained herein are subject to change without notice due to product/technology improvement, etc. When designing equipment, refer to the "Delivery Specification" for the SANYO product that you intend to use.
- Information (including circuit diagrams and circuit parameters) herein is for example only; it is not guaranteed for volume production. SANYO believes information herein is accurate and reliable, but no guarantees are made or implied regarding its use or any infringements of intellectual property rights or other rights of third parties.

This catalog provides information as of March, 2000. Specifications and information herein are subject to change without notice.