

High Intensity LED in ø 3 mm Tinted Non – Diffused Package

Color	Type	Technology	Angle of Half Intensity $\pm\varphi$
Soft orange	TLHF4200	AllnGaP on GaAs	22°

Description

This device has been designed to meet the increasing demand for AllnGaP technology.

It is housed in a 3 mm clear plastic package. The small viewing angle of these devices provides a high brightness.

All LEDs are categorized in luminous intensity groups. That allows users to assemble LEDs with uniform appearance.

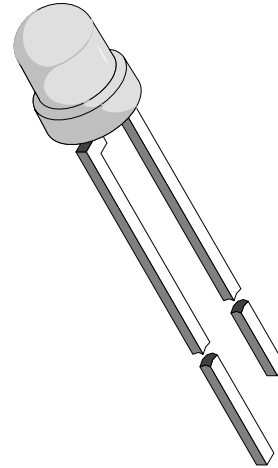

94 8488

Features

- AllnGaP technology
- Standard ø 3 mm (T-1) package
- Small mechanical tolerances
- Suitable for DC and high peak current
- Medium viewing angle
- Very high intensity
- Luminous intensity categorized

Applications

Status lights
 OFF / ON indicator
 Background illumination
 Readout lights
 Maintenance lights
 Legend light

Absolute Maximum Ratings

$T_{amb} = 25^{\circ}\text{C}$, unless otherwise specified

TLHF4200

Parameter	Test Conditions	Symbol	Value	Unit
Reverse voltage		V_R	5	V
DC forward current	$T_{amb} \leq 60^{\circ}\text{C}$	I_F	30	mA
Surge forward current	$t_p \leq 10 \mu\text{s}$	I_{FSM}	0.1	A
Power dissipation	$T_{amb} \leq 60^{\circ}\text{C}$	P_V	80	mW
Junction temperature		T_j	100	$^{\circ}\text{C}$
Operating temperature range		T_{amb}	-40 to +100	$^{\circ}\text{C}$
Storage temperature range		T_{stg}	-55 to +100	$^{\circ}\text{C}$
Soldering temperature	$t \leq 5 \text{ s}$, 2 mm from body	T_{sd}	260	$^{\circ}\text{C}$
Thermal resistance junction/ambient		R_{thJA}	400	K/W

Optical and Electrical Characteristics

$T_{amb} = 25^{\circ}\text{C}$, unless otherwise specified

Soft orange (TLHF4200)

Parameter	Test Conditions	Type	Symbol	Min	Typ	Max	Unit
Luminous intensity	$I_F = 10 \text{ mA}$		I_V	40	120		mcd
Dominant wavelength	$I_F = 10 \text{ mA}$		λ_d	598	605	611	nm
Peak wavelength	$I_F = 10 \text{ mA}$		λ_p		610		nm
Angle of half intensity	$I_F = 10 \text{ mA}$		ϕ		± 22		deg
Forward voltage	$I_F = 20 \text{ mA}$		V_F		1.9	2.6	V
Reverse voltage	$I_R = 10 \mu\text{A}$		V_R	5			V
Junction capacitance	$V_R = 0$, $f = 1 \text{ MHz}$		C_j		15		pF

Typical Characteristics ($T_{amb} = 25^{\circ}\text{C}$, unless otherwise specified)

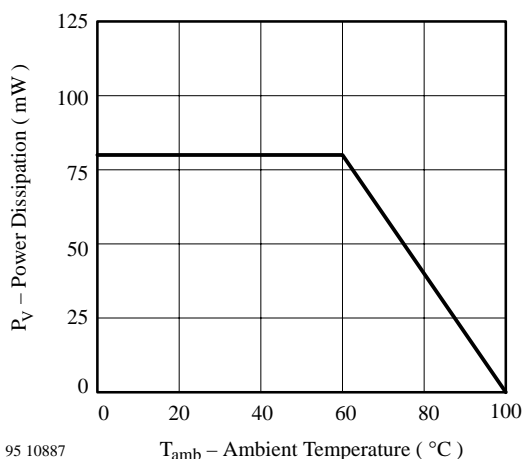

Figure 1 Power Dissipation vs. Ambient Temperature

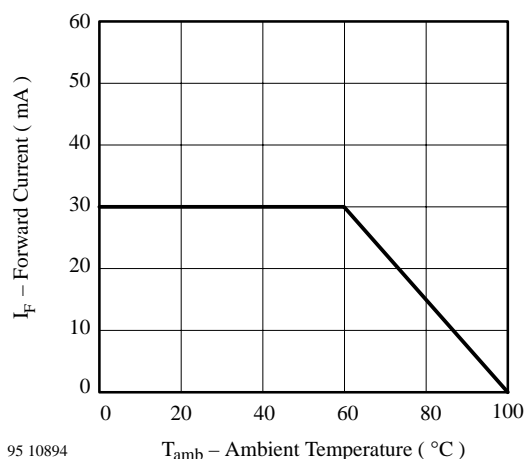

Figure 2 Forward Current vs. Ambient Temperature

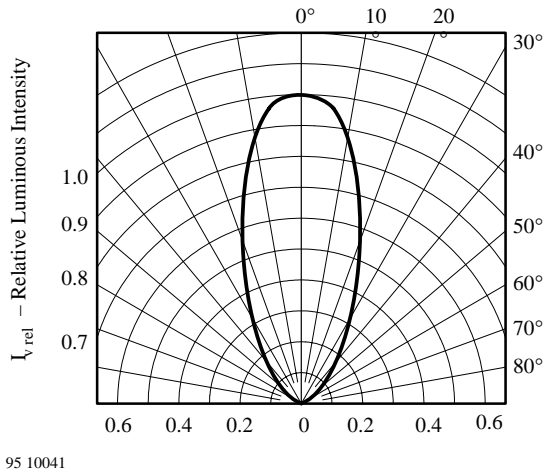

Figure 3 Rel. Luminous Intensity vs. Angular Displacement

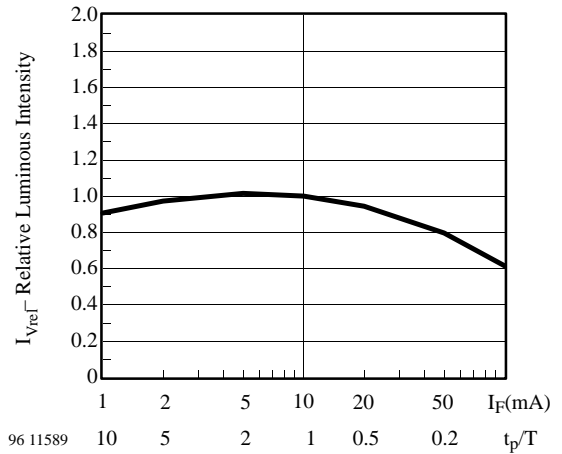

Figure 6 Rel. Lumin. Intensity vs. Forw. Current/Duty Cycle

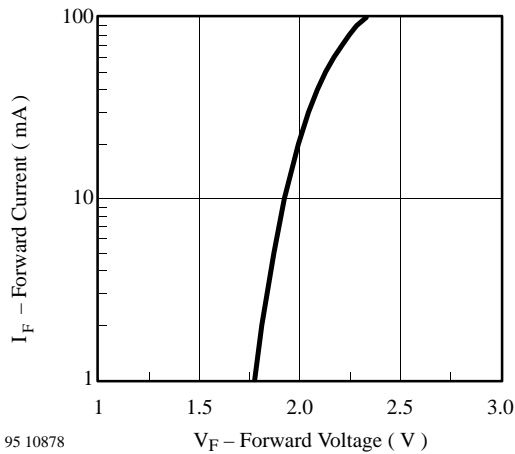

Figure 4 Forward Current vs. Forward Voltage

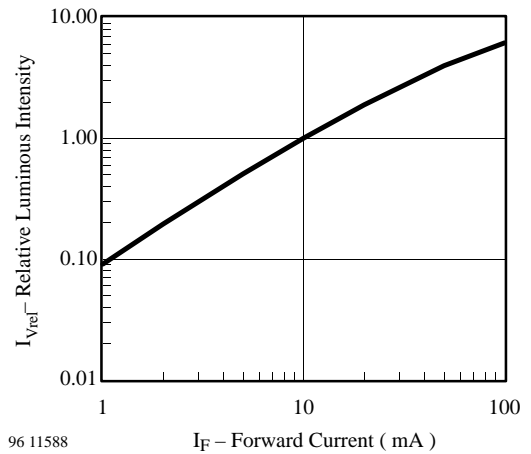

Figure 7 Relative Luminous Intensity vs. Forward Current

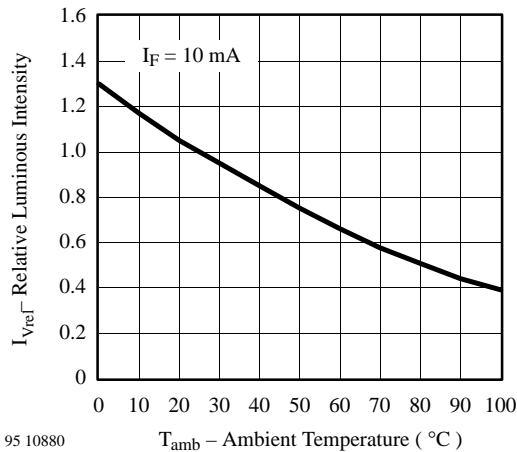

Figure 5 Rel. Luminous Intensity vs. Ambient Temperature

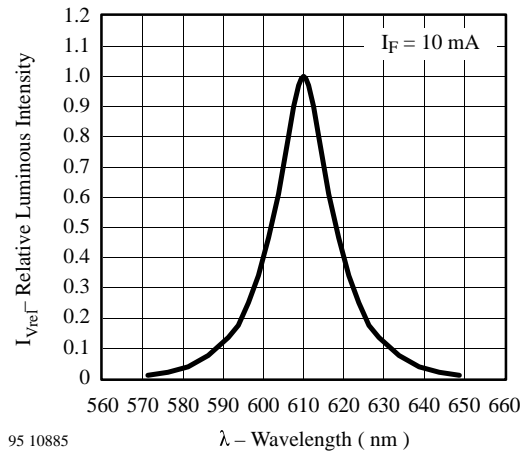
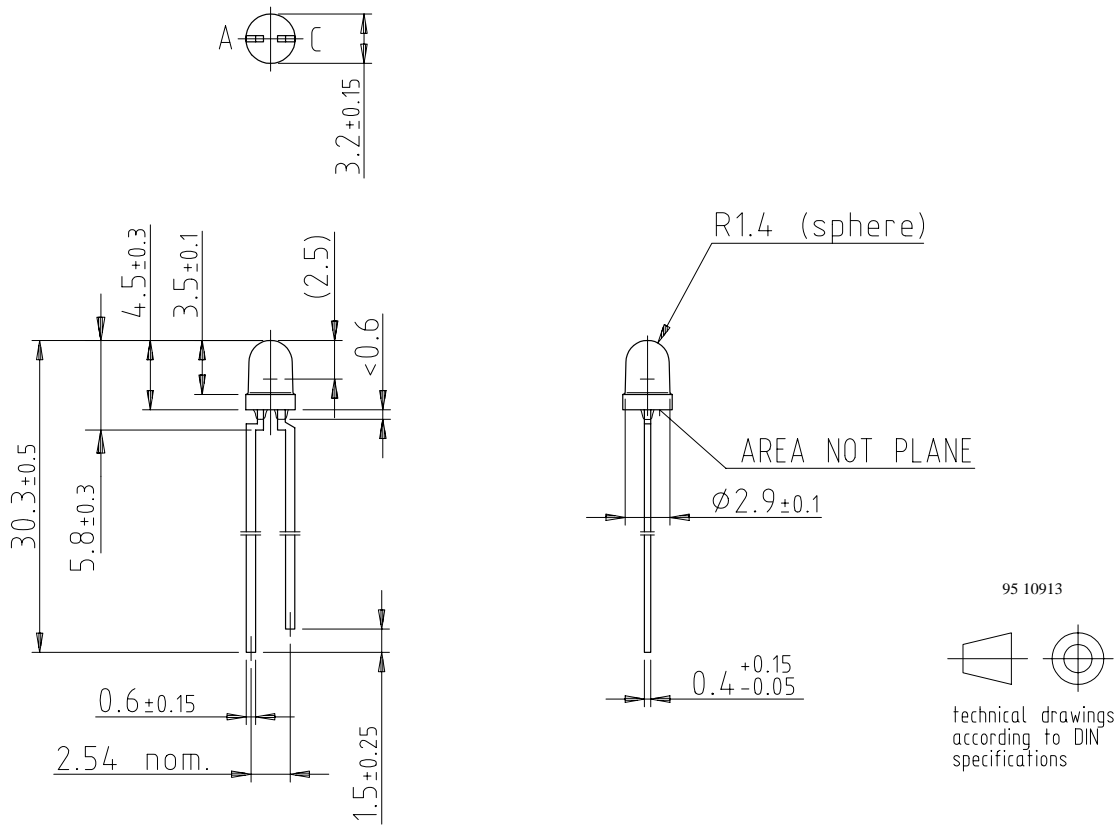

Figure 8 Relative Luminous Intensity vs. Wavelength

Dimensions in mm





Ozone Depleting Substances Policy Statement

It is the policy of **Vishay Semiconductor GmbH** to

1. Meet all present and future national and international statutory requirements.
2. Regularly and continuously improve the performance of our products, processes, distribution and operating systems with respect to their impact on the health and safety of our employees and the public, as well as their impact on the environment.

It is particular concern to control or eliminate releases of those substances into the atmosphere which are known as ozone depleting substances (ODSs).

The Montreal Protocol (1987) and its London Amendments (1990) intend to severely restrict the use of ODSs and forbid their use within the next ten years. Various national and international initiatives are pressing for an earlier ban on these substances.

Vishay Semiconductor GmbH has been able to use its policy of continuous improvements to eliminate the use of ODSs listed in the following documents.

1. Annex A, B and list of transitional substances of the Montreal Protocol and the London Amendments respectively
2. Class I and II ozone depleting substances in the Clean Air Act Amendments of 1990 by the Environmental Protection Agency (EPA) in the USA
3. Council Decision 88/540/EEC and 91/690/EEC Annex A, B and C (transitional substances) respectively.

Vishay Semiconductor GmbH can certify that our semiconductors are not manufactured with ozone depleting substances and do not contain such substances.

We reserve the right to make changes to improve technical design and may do so without further notice.

Parameters can vary in different applications. All operating parameters must be validated for each customer application by the customer. Should the buyer use Vishay-Telefunken products for any unintended or unauthorized application, the buyer shall indemnify Vishay-Telefunken against all claims, costs, damages, and expenses, arising out of, directly or indirectly, any claim of personal damage, injury or death associated with such unintended or unauthorized use.

Vishay Semiconductor GmbH, P.O.B. 3535, D-74025 Heilbronn, Germany
Telephone: 49 (0)7131 67 2831, Fax number: 49 (0)7131 67 2423