

SANYO

No. 3934B

LC66562A, LC66566A**4-bit Microcontrollers with Built-in ROM**

OVERVIEW

The LC66562A and LC66566A are 4-bit microcontrollers with built-in 12 and 16 Kbyte ROMs, respectively. They incorporate RAM, input/output ports, a serial interface, a comparator and timers in a single chip.

The LC66562A and LC66566A feature a large instruction set compatible with that of the LC66000 series devices. They are functionally identical to the LC66512B, LC66516B, LC66E516 and LC66P516, but have a different supply voltage range and hold-mode release time.

The LC66562A and LC66566A operate from a 5 V supply and are available in 64-pin DIPs and 64-pin QIPs.

FEATURES

- 12 or 16 Kbyte ROM and 512-word, 4-bit RAM
- Instruction set compatible with the LC66000 series
- 8-bit serial interface which supports 16-bit cascade connection
- 1.96 μ s minimum cycle time at 3.0 to 5.5 V, and 3.92 μ s, at 2.2 to 5.5 V
- 12-bit timer for timeout function, event counter, pulse measurement and rectangular waveform generation
- 8-bit timer for timeout function, event counter, pulsewidth modulated output and rectangular waveform generation
- 12-bit pre-scaler for timebase function
- Six external interrupt inputs
- Five internal interrupt sources (two for the timers, two for the serial I/O and one for the pre-scaler)
- 20 mA driver outputs with 15 V withstand voltage
- Ternary-level and comparator inputs
- I/O pull-up resistor and open-drain options
- Runaway detection option
- Halt and hold modes for program-controlled power-down
- LC66599 evaluation chip, EVA850/800-TB665XX debugger, LC66E516 EPROM and LC66P516 PROM development tools available
- 5 V supply
- 64-pin DIP and 64-pin QIP

SANYO Electric Co., Ltd. Semiconductor Business Headquarters

TOKYO OFFICE Tokyo Bldg., 1-10, 1 Chome, Ueno, Taito-ku, TOKYO, 110 JAPAN

PIN ASSIGNMENT

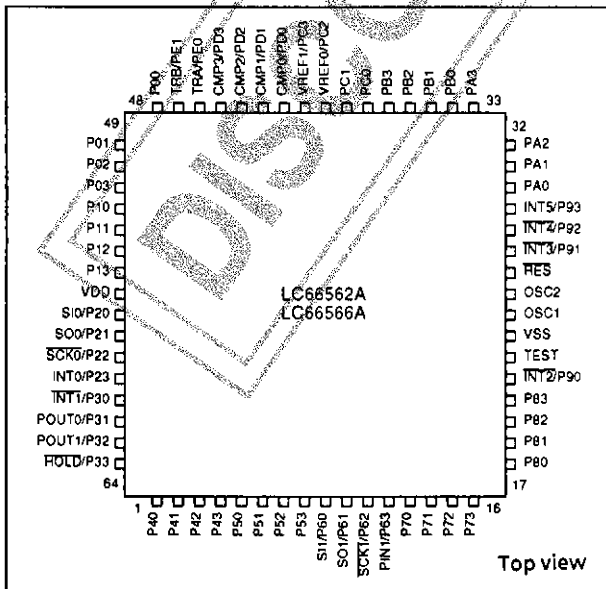
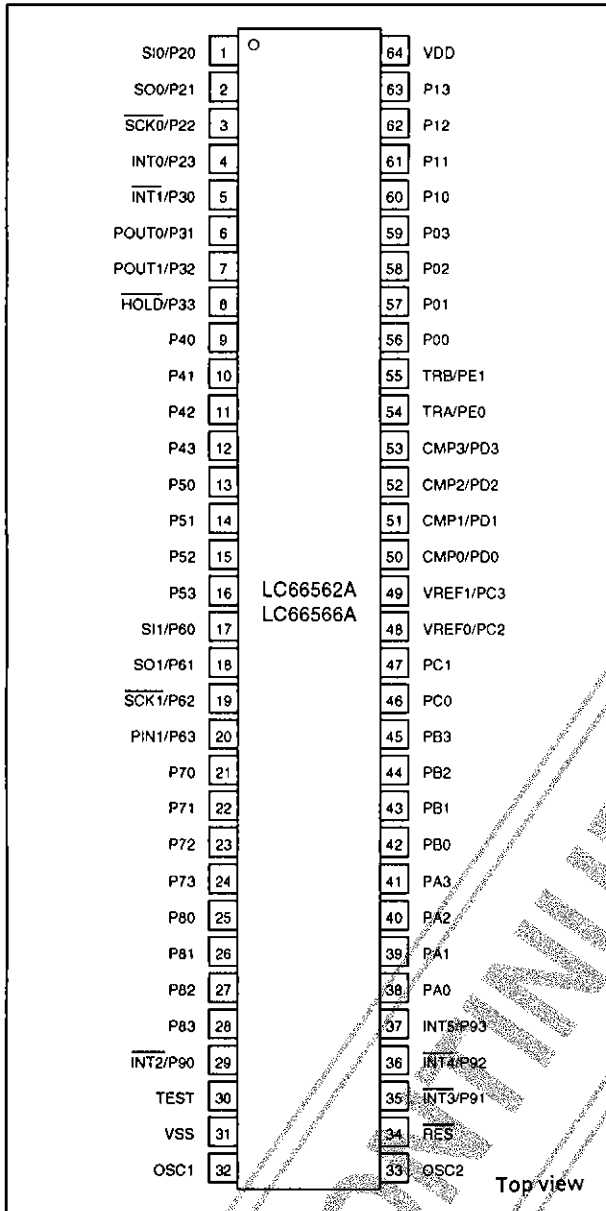

PACKAGE DIMENSIONS

Unit: mm

3071-DIP64S

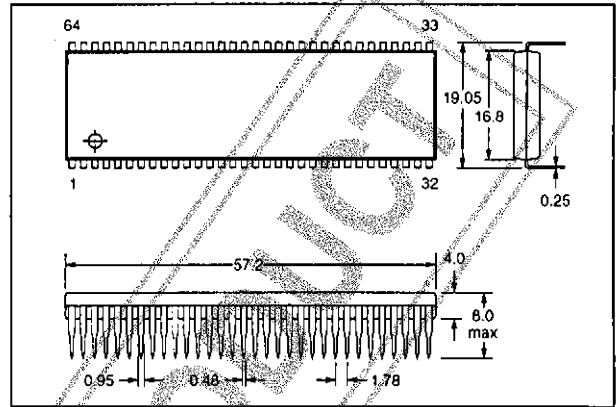

3159-QIP64E

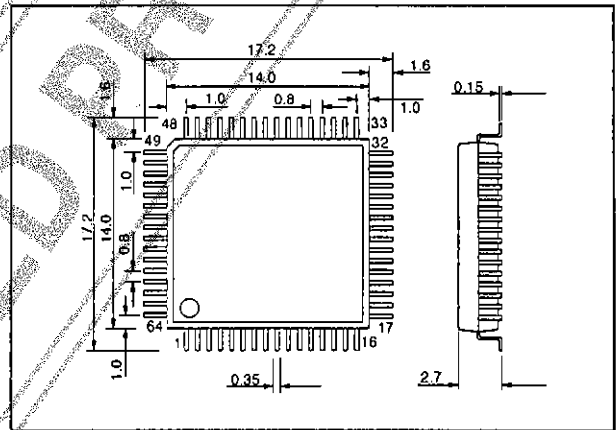

Note

Reflow soldering is recommended for QIP packages. Please consult your local representative for further information.

BLOCK DIAGRAM

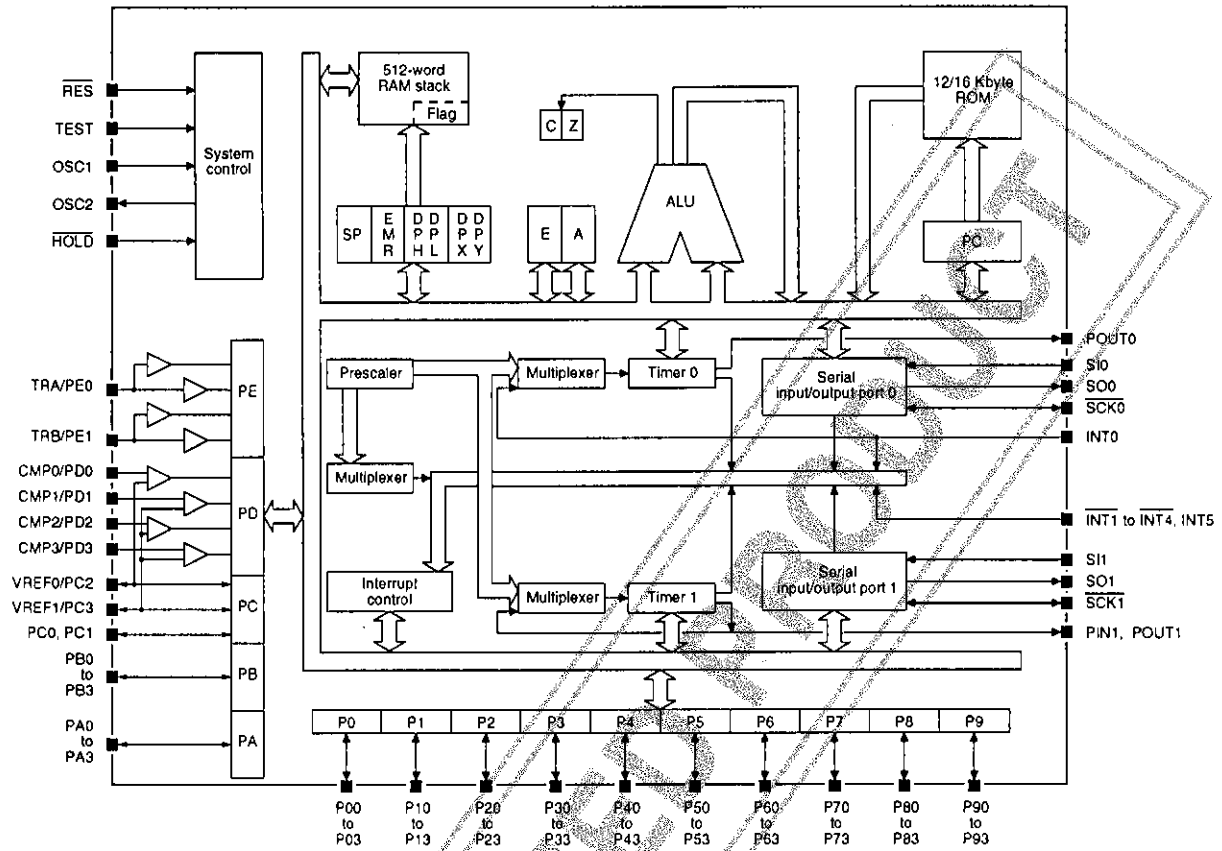

PIN DESCRIPTION

Number		Name	Description
DIP64S	QIP64E		
1	57	SIO/P20	Multiplexed 4-bit input/output port P2 (P20 to P23), serial input 0 (SIO), serial output 0 (SO0), serial clock 0 (SCK0) and interrupt request 0 (INT0)
2	58	SO0/P21	
3	59	SCK0/P22	
4	60	INT0/P23	
5	61	INT1/P30	
6	62	POUT0/P31	
7	63	POUT1/P32	
8	64	HOLD/P33	4-bit input/output port P4 (P40 to P43)
9	1	P40	
10	2	P41	
11	3	P42	
12	4	P43	4-bit input/output port P5 (P50 to P53)
13	5	P50	
14	6	P51	
15	7	P52	
16	8	P53	

LC66562A, LC66566A

Number		Name	Description
DIP64S	QIP64E		
17	9	S11/P60	Multiplexed 4-bit input/output port P6 (P60 to P63), serial input 1 (S11), serial output 1 (SO1), serial clock 1 (SCK1) and event counter input (PIN1)
18	10	SO1/P61	
19	11	SCK1/P62	
20	12	PIN1/P63	
21	13	P70	4-bit output port P7 (P70 to P73)
22	14	P71	
23	15	P72	
24	16	P73	
25	17	P80	4-bit output port P8 (P80 to P83)
26	18	P81	
27	19	P82	
28	20	P83	
29	21	INT2/P90	Multiplexed 4-bit input/output port P9 (P90 to P93) and interrupt requests (INT2 to INT4 and INT5)
35	27	INT3/P91	
36	28	INT4/P92	
37	29	INT5/P93	
30	22	TEST	CPU test input
31	23	VSS	Ground
32	24	OSC1	External oscillator connections
33	25	OSC2	
34	26	RES	Reset input
38	30	PA0	4-bit output port PA (PA0 to PA3)
39	31	PA1	
40	32	PA2	
41	33	PA3	
42	34	PB0	4-bit output port PB (PB0 to PB3)
43	35	PB1	
44	36	PB2	
45	37	PB3	
46	38	PC0	Multiplexed 4-bit input/output port PC (PC0 to PC3), comparator 0 reference voltage input (VREF0) and comparators 1, 2 and 3 reference voltage input (VREF1)
47	39	PC1	
48	40	VREF0/PC2	
49	41	VREF1/PC3	
50	42	CMP0/PD0	Multiplexed 4-bit input port PD (PD0 to PD3) and comparator inputs (CMP0 to CMP3)
51	43	CMP1/PD1	
52	44	CMP2/PD2	
53	45	CMP3/PD3	

LC66562A, LC66566A

Number		Name	Description
DIP64S	QIP64E		
54	46	TRA/PE0	Multiplexed 2-bit input port PE (PE0 to PE1) and ternary inputs (TRA and TRB)
55	47	TRB/PE1	
56	48	P00	4-bit input/output port P0 (P00 to P03)
57	49	P01	
58	50	P02	
59	51	P03	
60	52	P10	4-bit input/output port P1 (P10 to P13)
61	53	P11	
62	54	P12	
63	55	P13	
64	56	VDD	5 V supply

SPECIFICATIONS

Absolute Maximum Ratings

Parameter	Symbol	Rating	Unit
Supply voltage range	V_{DD}	-0.3 to 7.0	V
Ports P2, P3 (excluding P33) and P6 input voltage range. See note 1.	V_{in}	-0.3 to 15.0	V
Input voltage range for all inputs. See note 2.	V_{i2}	-0.3 to $V_{DD} + 0.3$	V
Ports P2, P3 (excluding P33), P6, P7 and PA output voltage range. See note 1.	V_{O1}	-0.3 to 15.0	V
Output voltage range for all outputs. See note 2.	V_{O2}	-0.3 to $V_{DD} + 0.3$	V
Ports P0, P1, P4, P5, P7, PA and PB output source current	$-I_{OP1}$	2	mA
Ports P2, P3 (excluding P33), P6, P8, P9 and PC output source current	$-I_{OP2}$	4	mA
Ports P0 to P6 (excluding P33), P8, P9 and PC output sink current	I_{ON1}	4	mA
Ports P7, PA and PB output sink current	I_{ON2}	20	mA
Ports P2 to P8 (excluding P33) total sink current	ΣI_{ON1}	75	mA
Ports P0, P1 and P9 to PC total sink current	ΣI_{ON2}	75	mA
Ports P2 to P8 (excluding P33) total source current	$-\Sigma I_{OP1}$	25	mA
Ports P0, P1 and P9 to PC total source current	$-\Sigma I_{OP2}$	25	mA
Power dissipation (DIP64S)	P_{D1}	600	mW
Power dissipation (QIP64E)	P_{D2}	430	mW
Operating temperature range	T_{OPF}	-30 to 70	°C
Storage temperature range	T_{stg}	-55 to 125	°C

Notes

1. Open-drain output configuration option
2. All output configuration options

Recommended Operating Conditions

$T_a = 25\text{ }^\circ\text{C}$, $V_{SS} = 0\text{ V}$

Parameter	Symbol	Rating	Unit
Supply voltage	V_{DD}	5	V
Supply voltage range for $1.96 \leq t_{CYC} \leq 10\text{ }\mu\text{s}$ operation	V_{DD}	3.0 to 5.5	V
Supply voltage range for $3.92 \leq t_{CYC} \leq 10\text{ }\mu\text{s}$ operation		2.2 to 5.5	
Hold-mode supply voltage range for data retention	V_{DD}	1.8 to 5.5	V

Electrical Characteristics

$V_{DD} = 2.2\text{ to }5.5\text{ V}$, $V_{SS} = 0\text{ V}$, $T_a = -30\text{ to }70\text{ }^\circ\text{C}$ unless otherwise noted

Parameter	Symbol	Condition	Rating			Unit
			min	typ	max	
Supply current	I_{DD}	2 MHz ceramic resonator, $V_{DD} = 3.0\text{ to }5.5\text{ V}$	-	1.5	4.0	mA
		2 MHz external clock, $V_{DD} = 3.0\text{ to }5.5\text{ V}$	-	1.5	4.0	
		1 MHz ceramic resonator	-	1.0	4.0	
Halt-mode supply current	I_{DDHT}	2 MHz ceramic resonator, $V_{DD} = 3.0\text{ to }5.5\text{ V}$	-	0.8	1.5	mA
		2 MHz external clock, $V_{DD} = 3.0\text{ to }5.5\text{ V}$	-	0.8	1.5	
		1 MHz ceramic resonator	-	0.5	1.5	
Hold-mode supply current	I_{DDHD}	$V_{DD} = 1.8\text{ to }5.5\text{ V}$	-	0.01	10.0	μA
Ports P2, P3 (excluding P33), P6 and P9, RES and OSC1 LOW-level input voltage	V_{IL1}	Output n-channel transistor OFF. See note 1.	V_{SS}	-	$0.2V_{DD}$	V
HOLD/P33 LOW-level input voltage	V_{IL2}	$V_{DD} = 1.8\text{ to }5.5\text{ V}$	V_{SS}	-	$0.2V_{DD}$	V
Ports P0, P1, P4, P5, PC, PD and PE, and TEST LOW-level input voltage	V_{IL3}	Output n-channel transistor OFF. See note 1.	V_{SS}	-	$0.25V_{DD}$	V
Port PE LOW-level input voltage	V_{IL4}	Ternary input levels, $V_{DD} = 2.7\text{ to }5.5\text{ V}$	V_{SS}	-	$0.2V_{DD}$	V
Port PE MID-level input voltage	V_{IM}	Ternary input levels, $V_{DD} = 2.7\text{ to }5.5\text{ V}$	$0.4V_{DD}$	-	$0.6V_{DD}$	V
Ports P2, P3 (excluding P33) and P6 HIGH-level input voltage	V_{IH1}	Output n-channel transistor OFF. See notes 1 and 2.	$0.8V_{DD}$	-	13.5	V
HOLD/P33, P9, RES and OSC1 HIGH-level input voltage	V_{IH2}	Output n-channel transistor OFF. See note 2.	$0.8V_{DD}$	-	V_{DD}	V
Ports P0, P1, P4, P5, PC, PD and PE HIGH-level input voltage	V_{IH3}	Output n-channel transistor OFF. See note 1.	$0.75V_{DD}$	-	V_{DD}	V
Port PE HIGH-level input voltage	V_{IH4}	Ternary input levels, $V_{DD} = 2.7\text{ to }5.5\text{ V}$	$0.8V_{DD}$	-	V_{DD}	V
Ports P0 to P6 (excluding P33), PB (CMOS), P9 and PC LOW-level output voltage	V_{OL1}	$I_{OL} = 1.6\text{ mA}$	-	-	0.4	V
Ports P7, PA and PB LOW-level output voltage	V_{OL2}	$I_{OL} = 3\text{ mA}$	-	-	1.5	V
		$I_{OL} = 8\text{ mA}$, $V_{DD} = 3.0\text{ to }5.5\text{ V}$	-	-	1.5	

LC66562A, LC66566A

Parameter	Symbol	Condition	Rating			Unit
			min	typ	max	
Ports P2, P3 (excluding P33), P6, P8, P9 and PC HIGH-level output voltage	V_{OH1}	$I_{OH} = -1 \text{ mA}$, $V_{DD} = 3.0 \text{ to } 5.5 \text{ V}$. See note 3.	$V_{DD} - 1.0$	-	-	V
		$I_{OH} = -0.5 \text{ mA}$. See note 3.	$V_{DD} - 1.0$	-	-	
		$I_{OH} = -0.1 \text{ mA}$. See note 3.	$V_{DD} - 0.5$	-	-	
Ports P0, P1, P4, P5, P7, PA and PB HIGH-level output voltage	V_{OH2}	$I_{OH} = -50 \text{ } \mu\text{A}$, $V_{DD} = 3.0 \text{ to } 5.5 \text{ V}$. See note 4.	$V_{DD} - 1.0$	-	-	V
		$I_{OH} = -30 \text{ } \mu\text{A}$, $V_{DD} = 3.0 \text{ to } 5.5 \text{ V}$. See note 4.	$V_{DD} - 0.5$	-	-	
		$I_{OH} = -30 \text{ } \mu\text{A}$. See note 4.	$V_{DD} - 1.0$	-	-	
		$I_{OH} = -20 \text{ } \mu\text{A}$. See note 4.	$V_{DD} - 0.5$	-	-	
Ports PC2 and PD0 in-phase, comparator input voltage range	V_{CMM1}	$V_{DD} = 2.7 \text{ to } 5.5 \text{ V}$	1.5	-	V_{DD}	V
Ports PC3 and PD1 to PD3 in-phase, comparator input voltage range	V_{CMM2}	$V_{DD} = 2.7 \text{ to } 5.5 \text{ V}$	V_{SS}	-	$V_{DD} - 1.5$	V
Ports PD1 to PD3 comparator offset voltage	V_{OS1}	$V_I = V_{SS} \text{ to } V_{DD} - 1.5 \text{ V}$, $V_{DD} = 2.7 \text{ to } 5.5 \text{ V}$	-	± 50	± 300	mV
Port PD0 comparator offset voltage	V_{OS2}	$V_I = 1.5 \text{ V to } V_{DD}$, $V_{DD} = 2.7 \text{ to } 5.5 \text{ V}$	-	± 50	± 300	mV
Ports P2, P3, P6 and P9, and \overline{RES} and OSC1 Schmitt-trigger LOW-level threshold voltage	V_{IL}		$0.2V_{DD}$	-	$0.5V_{DD}$	V
Ports P2, P3, P6 and P9, and \overline{RES} and OSC1 Schmitt-trigger HIGH-level threshold voltage	V_{IH}		$0.5V_{DD}$	-	$0.8V_{DD}$	V
Ports P2, P3, P6 and P9, \overline{RES} and OSC1 Schmitt-trigger hysteresis voltage	V_{HYS}		-	$0.1V_{DD}$	-	V
Ports PC2, PC3, PD and PE LOW-level input current	I_{IL1}	$V_I = V_{SS}$, output n-channel transistor OFF. See note 2.	-1.0	-	-	μA
LOW-level input current for all other inputs	I_{IL2}	$V_I = V_{SS}$, output n-channel transistor OFF. See note 2.	-1.0	-	-	μA
Ports P2, P3 (excluding P33) and P6 HIGH-level input current	I_{IH1}	$V_I = 13.5 \text{ V}$, output n-channel transistor OFF. See notes 1 and 2.	-	-	5.0	μA
Ports P0, P1, P33, P4, P5, P9, PC (excluding PC2 and PC3) and \overline{RES} and OSC1, HIGH-level input current	I_{IH2}	$V_I = V_{DD}$, output n-channel transistor OFF. See notes 1 and 2.	-	-	1.0	μA
Ports PC2, PC3, PD and PE HIGH-level input current	I_{IH3}	$V_I = V_{DD}$, output n-channel transistor OFF. See notes 1 and 2.	-	-	1.0	μA
Ports P2, P3, P6, P7 and PA output leakage current	I_{OFF1}	$V_I = 13.5 \text{ V}$. Output n-channel transistor OFF. See note 2.	-	-	5.0	μA
Ports P0, P1, P4, P5, P9, PB and PC output leakage current	I_{OFF2}	$V_I = V_{DD}$. Output n-channel transistor OFF. See note 2.	-	-	1.0	μA

LC66562A, LC66566A

Parameter	Symbol	Condition	Rating			Unit
			min	typ	max	
Port P8 output leakage current	I_{OFF3}	$V_I = V_{SS}$. Output p-channel transistor OFF. See note 2.	-1.0	-	-	μA
Ports P0, P1, P4, P5, P7, PA and PB output current with pull-up option	I_{PO}	$V_I = V_{SS}$, $V_{DD} = 5.5 V$. Output n-channel transistor OFF. See note 4.	-1.6	-	-	mA
Ceramic resonator input frequency	f_{CF}	$V_{DD} = 3.0$ to $5.5 V$, 2 MHz resonator	-	2.0	-	MHz
		1 MHz resonator	-	1.0	-	
Ceramic resonator input stabilization time	t_{CFS}	$V_{DD} = 3.0$ to $5.5 V$, 2 MHz resonator	-	-	10	ms
		1 MHz resonator	-	-	10	
OSC1 external clock input frequency	f_{ext}	$V_{DD} = 3.0$ to $5.5 V$	0.4	-	2.03	MHz
			0.4	-	1.02	

Notes

1. Ports with CMOS output configuration option cannot be used as input ports
2. Open-drain output configuration option
3. CMOS output configuration option
4. Pull-up output configuration option

Timing Characteristics

Serial input/output timing

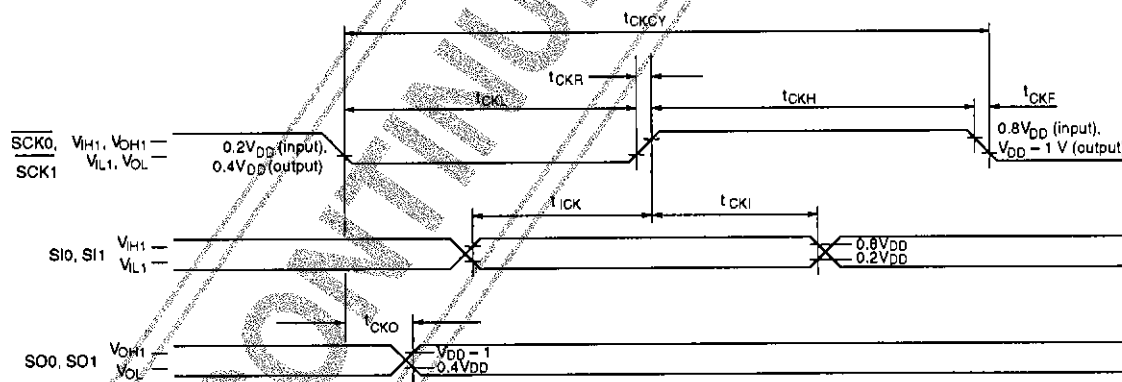

$V_{DD} = 2.2$ to $5.5 V$, $V_{SS} = 0 V$, $T_a = -30$ to $70 ^\circ C$

Parameter	Symbol	Condition	Rating			Unit
			min	typ	max	
Instruction cycle time	t_{CYC}	$f_{OP} = 0.4$ to 2.03 MHz, $V_{DD} = 3.0$ to $5.5 V$	10	-	1.96	μs
		$f_{CYC} = 0.4$ to 1.02 MHz	10	-	3.92	
$\overline{SCK0}$ and $\overline{SCK1}$ serial clock input cycle time	t_{CKCY}	$V_{DD} = 3.0$ to $5.5 V$	1.9	-	-	μs
$\overline{SCK0}$ and $\overline{SCK1}$ serial clock output cycle time			3.9	-	-	
			$2t_{CYC}$	-	-	

LC66562A, LC66566A

Parameter	Symbol	Condition	Rating			Unit
			min	typ	max	
$\overline{\text{SCK0}}$ and $\overline{\text{SCK1}}$ serial clock input pulsewidth	t_{CKL}	$V_{\text{DD}} = 3.0$ to 5.5 V	0.9	-	-	μs
			1.9	-	-	
$\overline{\text{SCK0}}$ and $\overline{\text{SCK1}}$ serial clock output pulsewidth			t_{CYC}	-	-	
$\overline{\text{SCK0}}$ and $\overline{\text{SCK1}}$ serial clock output rise time	t_{CKR}		-	-	0.1	μs
$\overline{\text{SCK0}}$ and $\overline{\text{SCK1}}$ serial clock output fall time	t_{CKF}		-	-	0.1	μs
SIO and SI1 serial data setup time	t_{ICK}		0.6	-	-	μs
SIO and SI1 serial data hold time	t_{CI}		0.6	-	-	μs
SO0 and SO1 serial data output delay	t_{CO}	$V_{\text{DD}} = 3.0$ to 5.5 V	-	-	0.6	μs
			-	-	0.9	

Note

Each test input and output has an RC load as shown in the following figure.

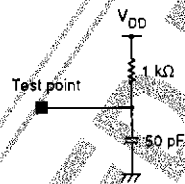

External clock timing

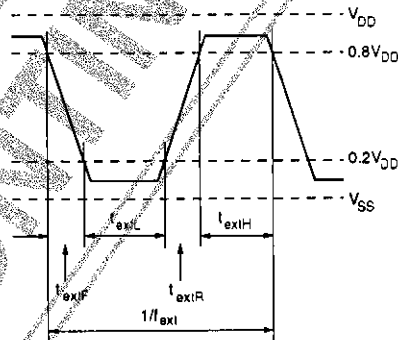

$V_{\text{DD}} = 2.2$ to 5.5 V, $V_{\text{SS}} = 0$ V, $T_{\text{a}} = -30$ to 70 °C

Parameter	Symbol	Condition	Rating			Unit
			min	typ	max	
OSC1 external clock LOW-level input pulsewidth	t_{extL}	$V_{\text{DD}} = 3.0$ to 5.5 V	100	-	-	ns
			200	-	-	
OSC1 external clock HIGH-level input pulsewidth	t_{extH}	$V_{\text{DD}} = 3.0$ to 5.5 V	100	-	-	ns
			200	-	-	
OSC1 external clock input rise time	t_{extR}		-	-	30	ns
OSC1 external clock input fall time	t_{extF}		-	-	30	ns

Interrupt and reset timing

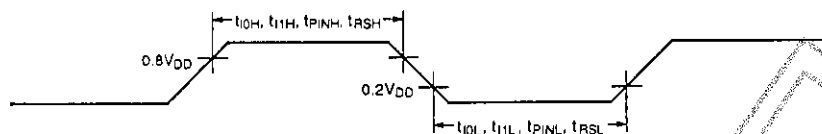

$V_{DD} = 2.2$ to 5.5 V, $V_{SS} = 0$ V, $T_a = -30$ to 70 °C

Parameter	Symbol	Rating			Unit
		min	typ	max	
INT0 LOW-level pulsewidth	t_{IOL}	2tcyc	-	-	μ s
INT0 HIGH-level pulsewidth	t_{IOH}	2tcyc	-	-	μ s
$\overline{INT1}$ to INT4 and INT5 LOW-level pulsewidth	t_{I1L}	2tcyc	-	-	μ s
$\overline{INT1}$ to INT4 and INT5 HIGH-level pulsewidth	t_{I1H}	2tcyc	-	-	μ s
PIN1 LOW-level input pulsewidth	t_{PINL}	2tcyc	-	-	μ s
PIN1 HIGH-level input pulsewidth	t_{PINH}	2tcyc	-	-	μ s
\overline{RES} LOW-level input pulsewidth	t_{RSL}	3tcyc	-	-	μ s
\overline{RES} HIGH-level input pulsewidth	t_{RSH}	3tcyc	-	-	μ s

Comparator output timing

$V_{DD} = 2.7$ to 5.5 V, $V_{SS} = 0$ V, $T_a = -30$ to 70 °C

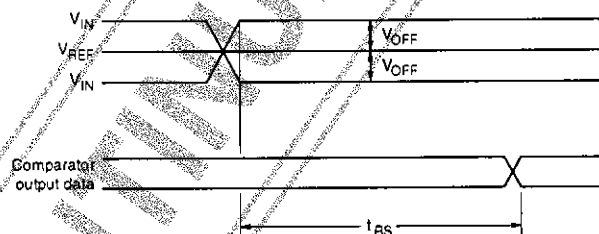

Parameter	Symbol	Condition	Rating			Unit
			min	typ	max	
Port PD comparator response time	t_{RS}	$V_{DD} = 2.7$ to 5.5 V	-	-	20	ms

INPUT AND OUTPUT FUNCTIONS

The LC66562A and LC66566A have many multiplexed pins whose functions are controlled by software. The function of each pin is described in table 1.

Table 1. Pin functions

Name	Function
P00	Ports P00 to P03 can be addressed as either a 4-bit port or four, single-bit ports. They also have halt-mode control functions. Level after reset is set by user option.
P01	
P02	
P03	

LC66562A, LC66566A

Table 1. Pin functions—continued

Name	Function
P10	Ports P10 to P13 can be addressed as either a 4-bit port or four, single-bit ports. Level after reset is set by user option.
P11	
P12	
P13	
SI0/P20	Ports P20 to P23 can be addressed as either a 4-bit port or four, single-bit ports. Port P20 also functions as a serial data input, P21 as a serial data output, P22 as a serial data clock and P23 as an interrupt request, pulsewidth measurement and event counter input using timer 0. HIGH-level after reset
SO0/P21	
SCK0/P22	
INT0/P23	
$\overline{\text{INT1}}$ /P30	Ports P30 to P32 can be addressed as either a 3-bit port, a 4-bit port with P33 or three, single-bit ports. Port P30 also functions as an interrupt request input, P31 as a square-wave output from timer 0, and P32 as a square-wave output and a PWM output from timer 1. HIGH-level after reset
POUT0/P31	
POUT1/P32	
$\overline{\text{HOLD}}$ /P33	Port P33 can be addressed as either a 4-bit port with P30 to P32 or a single-bit port. It functions as the hold-mode control input when P33 is LOW and the HOLD instruction is executed. The CPU restarts when P33 goes HIGH again. Reset signals are ignored whenever $\overline{\text{HOLD}}$ /P33 is LOW, including when not in hold mode.
P40	Ports P40 to P43 can be addressed as either a 4-bit port, four, single-bit ports or an 8-bit port with P50 to P53. HIGH-level after reset
P41	
P42	
P43	
P50	Ports P50 to P53 can be addressed as either a 4-bit port, four, single-bit ports or an 8-bit port with P40 to P43. HIGH-level after reset
P51	
P52	
P53	
SI1/P60	Ports P60 to P63 can be addressed as either a 4-bit port or four, single-bit ports. Port P60 also functions as a serial data input, P61 as a serial data output, P62 as a serial data clock and P63 as the timer 1 event counter input. HIGH-level after reset
SO1/P61	
SCK1/P62	
PIN1/P63	
P70	Ports P70 to P73 can be addressed as either a 4-bit port or four, single-bit ports. Input instructions read the contents of the output latch. HIGH-level after reset
P71	
P72	
P73	
P80	Ports P80 to P83 can be addressed as either a 4-bit port or four, single-bit ports. Input instructions read the contents of the output latch. Level after reset is set by user option. Note that the open-drain option for P8 is p-channel.
P81	
P82	
P83	
$\overline{\text{INT2}}$ /P90	Ports P90 to P93 can be addressed as either a 4-bit port or four, single-bit ports. P90 also functions as interrupt request 2, P91 as interrupt request 3, P92 as interrupt request 4 and P93 as interrupt request 5. HIGH-level after reset
$\overline{\text{INT3}}$ /P91	
$\overline{\text{INT4}}$ /P92	
$\overline{\text{INT5}}$ /P93	
$\overline{\text{INT5}}$ /P93	

Table 1. Pin functions—continued

Name	Function
PA0	Ports PA0 to PA3 can be addressed as either a 4-bit port or four, single-bit ports. Input instructions read the contents of the output latch. HIGH-level after reset
PA1	
PA2	
PA3	
PB0	Ports PB0 to PB3 can be addressed as either a 4-bit port or four, single-bit ports. Input instructions read the contents of the output latch. HIGH-level after reset
PB1	
PB2	
PB3	
PC0	Ports PC0 to PC3 can be addressed as either a 4-bit port or four, single-bit ports. Port PC2 also functions as the reference voltage input for comparator 0, and PC3, as the reference voltage input for comparators 1, 2 and 3. HIGH-level after reset
PC1	
VREF0/PC2	
VREF1/PC3	
CMP0/PD0	Ports PD0 to PD3 can be addressed as either a 4-bit port or four, single-bit ports. They also function as comparator inputs. Normal input after reset.
CMP1/PD1	
CMP2/PD2	
CMP3/PD3	
TRA/PE0	Ports PE0 to PE1 can be addressed as either a 2-bit port or two, single-bit ports. They also function as ternary-level inputs. Normal input after reset
TRB/PE1	
OSC1	OSC1 and OSC2 function as the external ceramic resonator connections. When an external clock is used, OSC2 is left open.
OSC2	
RES	When RES goes LOW while HOLD/P33 is HIGH, the CPU is reset.
TEST	CPU test input. Normally connected to ground

USER OPTIONS

Oscillator Options

There are two user options for the oscillator—an external clock and a ceramic resonator. An external RC oscillator is not supported. The internal circuits of OSC1 and OSC2 and connections for the external clock and ceramic resonator options are shown in figures 1 and 2, respectively. Note the Schmitt-trigger input for the external clock option.

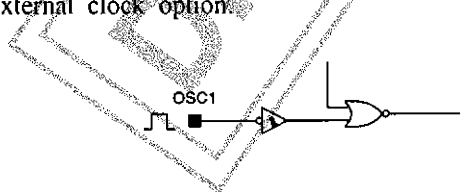

Figure 1. External clock option

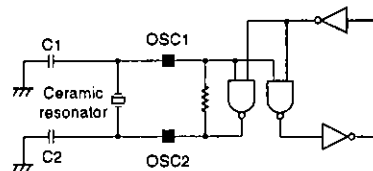

Figure 2. Ceramic resonator option

Output Options

There are two user options for the output configuration of each port—n-channel open drain and p-channel, active pull-up. The options for all ports, excluding P8, PD and PE, are shown in figures 3 and 5, and for P8, in figures 4 and 6. Note that the open-drain option for port P8 is p-channel. Ports P2, P3, P6 and P9 have Schmitt-trigger inputs in both output configurations.

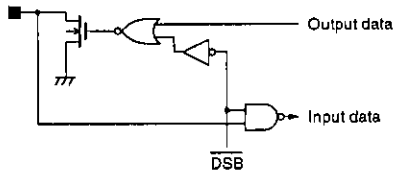

Figure 3. N-channel open-drain option for all ports except P8

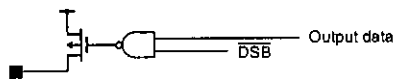

Figure 4. P-channel open-drain option for port P8

The p-channel pull-up option for all ports is identical. However, the ports are classified as pull-up or CMOS according to the drive capability of the p-channel transistor. Ports P0, P1, P4, P5, P7, PA and PB are classified as pull-up, and ports P2, P3, P6, P9 and PC, as CMOS.

SPECIFYING OPTIONS

The user-addressable memory is in the range 0000H to 3FFFH. Addresses 0000H to 3FF7H are for user programs, and addresses 3FF8H to 3FFFH, for option specification. The option specification is coded using the

Table 2. User options

Address	Data bit	Parameter	Option	
			0	1
3FF8H	D0	Watchdog timer function	No	Yes
	D1	Port P0 level after reset	LOW	HIGH
	D2	Port P1 level after reset	LOW	HIGH
	D3	Port P8 level after reset	LOW	HIGH
	D4	Oscillator	External clock	Ceramic resonator
	D5 to D7	No function	Set to 0	

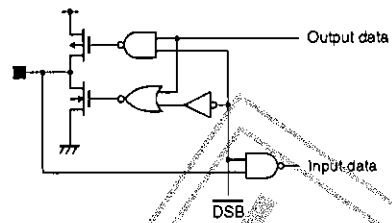

Figure 5. P-channel pull-up option for all ports except P8, PD and PE

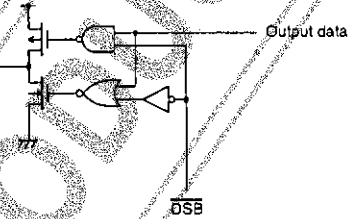

Figure 6. P-channel pull-up option for port P8

Note that the n-channel open-drain outputs for ports P2, P3, P6, P7 and PA have a maximum withstand voltage of 15 V.

Output Level After Reset Option

The output level of ports P0, P1 and P8 after a CPU reset is user selectable.

Watchdog Timer Option

A watchdog timer is also available to prevent program runaway.

information shown in table 2. Refer to the *LC66S Jump Optimizing Cross Assembler Manual* for setting information.

LC66562A, LC66566A

Table 2. User options—continued

Address	Data bit	Parameter	Option	
			0	1
3FF9H	D0	Port P00 output configuration	Open-drain	Pull-up
	D1	Port P01 output configuration		
	D2	Port P02 output configuration		
	D3	Port P03 output configuration		
	D4	Port P10 output configuration	Open-drain	Pull-up
	D5	Port P11 output configuration		
	D6	Port P12 output configuration		
	D7	Port P13 output configuration		
3FFAH	D0	Port P20 output configuration	Open-drain	CMOS
	D1	Port P21 output configuration		
	D2	Port P22 output configuration		
	D3	Port P23 output configuration		
	D4	Port P30 output configuration	Open-drain	CMOS
	D5	Port P31 output configuration		
	D6	Port P32 output configuration		
	D7	No function		
3FFBH	D0	Port P40 output configuration	Open-drain	Pull-up
	D1	Port P41 output configuration		
	D2	Port P42 output configuration		
	D3	Port P43 output configuration		
	D4	Port P50 output configuration	Open-drain	Pull-up
	D5	Port P51 output configuration		
	D6	Port P52 output configuration		
	D7	Port P53 output configuration		
3FFCH	D0	Port P60 output configuration	Open-drain	CMOS
	D1	Port P61 output configuration		
	D2	Port P62 output configuration		
	D3	Port P63 output configuration		
	D4	Port P70 output configuration	Open-drain	Pull-up
	D5	Port P71 output configuration		
	D6	Port P72 output configuration		
	D7	Port P73 output configuration		

Table 2. User options—continued

Address	Data bit	Parameter	Option	
			0	1
3FFDH	D0	Port P80 output configuration	Open-drain	Pull-up
	D1	Port P81 output configuration		
	D2	Port P82 output configuration		
	D3	Port P83 output configuration		
	D4	Port P90 output configuration	Open-drain	CMOS
	D5	Port P91 output configuration		
	D6	Port P92 output configuration		
	D7	Port P93 output configuration		
3FFEH	D0	Port PA0 output configuration	Open-drain	Pull-up
	D1	Port PA1 output configuration		
	D2	Port PA2 output configuration		
	D3	Port PA3 output configuration		
	D4	Port PB0 output configuration	Open-drain	Pull-up
	D5	Port PB1 output configuration		
	D6	Port PB2 output configuration		
	D7	Port PB3 output configuration		
3FFFH	D0	Port PC0 output configuration	Open-drain	CMOS
	D1	Port PC1 output configuration		
	D2	Port PC2 output configuration		
	D3	Port PC3 output configuration		
	D4 to D7	No function	Set to 0	

The assembler execute command when specifying programs and options using a Sanyo cross assembler is LC66S.EXE.

APPLICATION NOTES

Reference Clock

The external circuit for a ceramic resonator is shown in figure 7, and the corresponding recommended resonator and component values, in table 3. The oscillator stabilization characteristics are shown in figure 8.

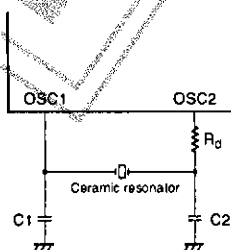

Figure 7. Ceramic resonator

Table 3. Recommended ceramic resonators

Ceramic resonator	R _d	C1	C2
2 MHz Murata CSA-2.00MG	0 Ω	33 pF ±10%	33 pF ±10%
2 MHz Kyocera KBR-2.0MS	0 Ω	47 pF ±10%	47 pF ±10%
1 MHz Murata CSB1000J	2.2 kΩ ±5%	100 pF ±10%	100 pF ±10%
1 MHz Kyocera KBR1000H	0 Ω	100 pF ±10%	100 pF ±10%

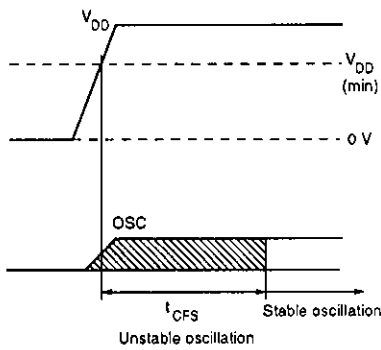

Figure 8. Ceramic resonator stabilization time

The external clock input connection is OSC1. The remaining oscillator connection, OSC2, should be left open as shown in figure 9.

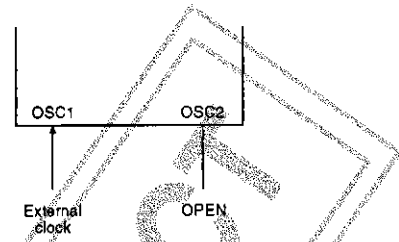

Figure 9. External clock connection

DEVELOPMENT TOOLS

Program development for the LC66562A and LC66566A microcontrollers can be performed using a cross assembler running on an IBM-compatible personal computer under MS-DOS. A number of other development tools are available to simplify and speed the

development process—the EVM800/850 debugger, the EVA800/850-TB665XX evaluation system, the LC66599 evaluation chip and the LC66E516 EPROM, shown in figure 10.

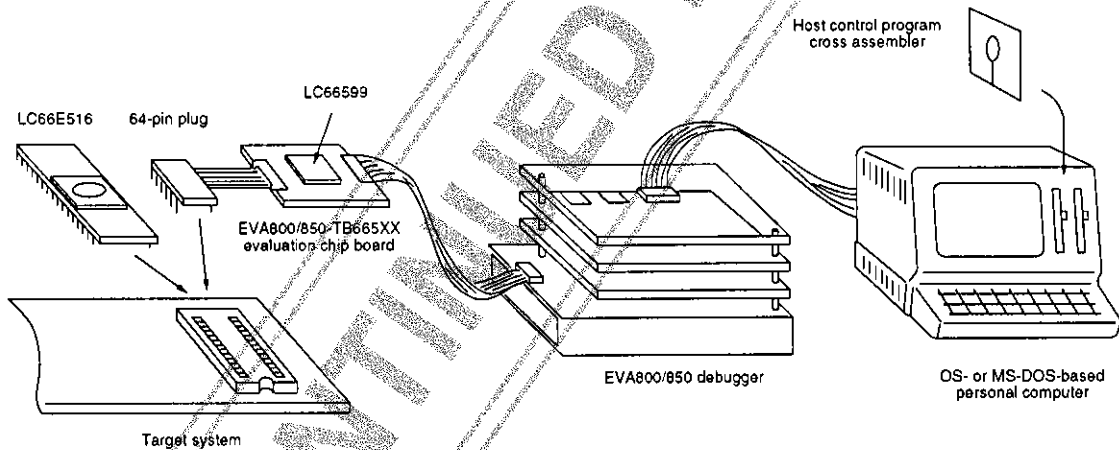

Figure 10. Development tools

Program Debugger

The EVA800/850 communicates with an external host computer using a standard serial interface. It performs basic debugging functions, including breakpoints,

single-stepping and tracing under MPM665XX debug monitor software control. It also includes an EPROM programmer.

Evaluation System

The evaluation chip board, which holds the LC66599 evaluation chip, has a 64-pin connector which plugs directly into the socket of a target system. Jumpers and

switches configure the initial device options and states as shown in tables 4 and 5.

Table 4. Jumper settings

Jumper 1		Jumper 2		Jumper 3	
Oscillator		Reset method		Target system supply source	
EXT	External clock	INT (a)	Reset on a RUN command from the host computer	ON (a)	Supply power from the evaluation chip board output
RC	RC oscillator				
CF	Ceramic filter resonator	EXT (b)	Reset by the target system reset circuit	OFF (b)	Separate evaluation chip and target system supplies

Note

An RC option is not supported. Accordingly, do not connect jumper 1 to the RC setting.

Table 5. Switch 1

P0S	Port P0 output level on reset	P1S	Port P1 output level on reset	P8S	Port P8 output level on reset	WDC	Watchdog timer enable
ON	All outputs HIGH	ON	All outputs HIGH	ON	All outputs HIGH	ON	Watchdog timer enabled
OFF	All outputs LOW	OFF	All outputs LOW	OFF	All outputs LOW	OFF	Watchdog timer disabled

Note

RC0 and RC1 should be turned ON together.

Switches 2 to 14 select the internal pull-up resistor option. When a switch is ON, the corresponding output pin has an internal pull-up resistor (pull-down resistor

for port P8 using SW10), and when OFF, the corresponding pin is an open-drain output.

Cross Assembler

The cross assembler execute file, LC66S.EXE, can be used for the devices shown in table 6. Refer to the

LC66S Jump Optimizing Cross Assembler Manual for operating information.

Table 6. Cross assembler compatibility

Cross assembler	Target device	Bank instructions supported
LC66S.EXE	LC66562A	SB0, SB1, SB2
	LC66566A, LC66E516, LC66P516, LC66599	SB0, SB1, SB2, SB3

Simulation Chip

The LC66E516 is a microprocessor with a 16-Kbyte EPROM which is used for simulation. It can be programmed by a standard EPROM programmer using the W66E516DH (DIP) or W66E516QH (QIP) adapter boards. The LC66E516 is pin- and functionally-compatible with the LC66562A and LC66566A devices. Note that the hold-mode release time and electrical specifications of the LC66E516 differ from those of the LC66562A and LC66566A.

The LC66E516, shown in figure 11, can be configured to match the target device by programming certain EPROM locations. These locations set the reset level of ports 0, 1 and 8, the watchdog timer enable and the port output types. Refer to the LC66E516 datasheet for further operating information.

Series Comparison

A comparison of the LC66516B series characteristics with those of the LC66562A and LC66566A is shown in table 7.

Table 7. Device comparison

Parameter	LC66516B series	LC66562A and LC66566A
Hold-mode release hardware delay	65,536 cycles (approximately 64 ms with a 4 MHz clock)	16,384 cycles (approximately 32 ms with a 2 MHz clock and 64 ms with a 1 MHz clock)
Timer 0 contents after reset	FF0H	FFCH
Operating supply voltage and clock period	4.0 to 6.0 V for 0.92 to 10 μs (LC66512B and LC66516B), 4.5 to 5.5 V for 0.92 to 10 μs (LC66E516 and LC66P516)	2.2 to 5.5 V for 3.92 to 10 ms, 3.0 to 5.5 V for 1.96 to 10 μs

Notes

1. The LC66562A and LC66566A do not support an RC oscillator.
2. Refer to the LC66516B, LC66E516 and LC66P516 datasheets for output drive current and comparator input voltages.

A breakdown of the LC66 series devices is shown in table 8.

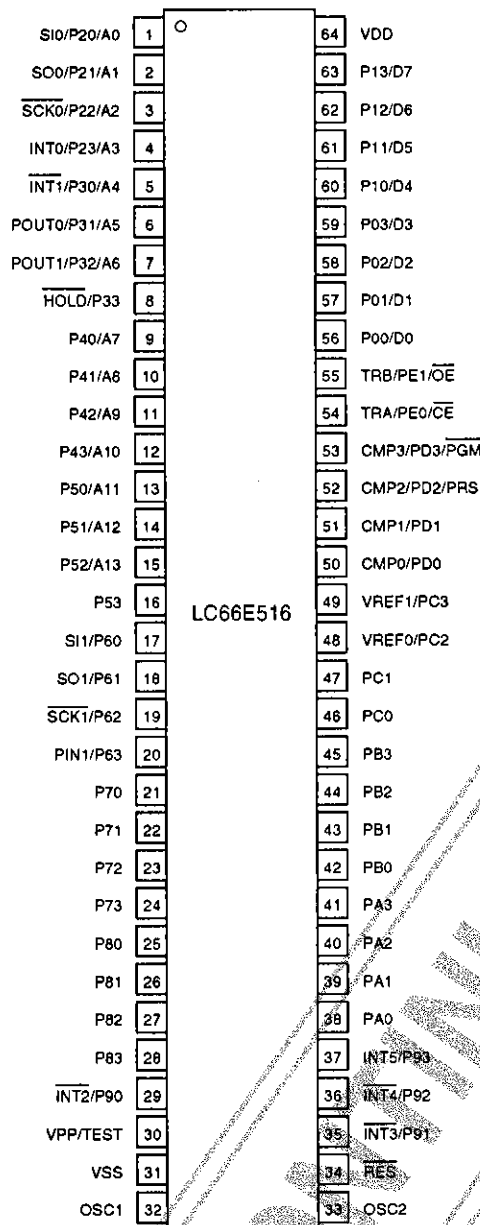

Figure 11. LC66E516 pinout

Table 8. LC66 series devices

Device	Pins	ROM capacity	RAM capacity	Package type	Type
LC66304A/306A/308A	42	4/6/8 Kbyte ROM	512 words	DIP42S and QIP48E	Normal type 4.0 to 6.0 V/0.92 μs
LC66404A/406A/408A	42	4/6/8 Kbyte ROM	512 words	DIP42S and QIP48E	
LC66506B/508B/512B/516B	64	6/8/12/16 Kbyte ROM	512 words	DIP64S and QIP64A	
LC66354A/356A/358A	42	4/6/8 Kbyte ROM	512 words	DIP42S and QIP48E	Low-voltage type 2.2 to 5.5 V/3.92 μs
LC66354S/356S/358S *	42	4/6/8 Kbyte ROM	512 words	QIP44M	
LC66556A/558A/562A/566A	64	6/8/12/16 Kbyte ROM	512 words	DIP64S and QIP64E	Low voltage, high-speed type 3.0 to 5.5 V/0.92 μs
LC66354B/356B/358B	42	4/6/8 Kbyte ROM	512 words	DIP42S and QIP48E	
LC66556B/558B	64	6/8 Kbyte ROM	512 words	DIP64S and QIP64E	
LC66562B/566B	64	12/16 Kbyte ROM	512 words	DIP64S and QIP64E	

LC66562A, LC66566A

Table 8. LC66 series devices—continued

Device	Pins	ROM capacity	RAM capacity	Package type	Type
LC66E308	42	8 Kbyte EPROM	512 words	DIC42S and QIC48	Evaluation ROMs and EPROMs with window 4.5 to 5.5 V/0.92 μs
LC66P308	42	8 Kbyte PROM	512 words	DIP42S and QIP48E	
LC66E408	42	8 Kbyte EPROM	512 words	DIC42S and QIC48	
LC66P408	42	8 Kbyte PROM	512 words	DIP42S and QIP48E	
LC66E516	64	16 Kbyte EPROM	512 words	DIC64S and QIC64	
LC66P516	64	16 Kbyte PROM	512 words	DIP64S and QIP64E	

* Under development

INSTRUCTION SET

The following abbreviations are used in the instruction set table:

AC	Accumulator	PCh	Bits 8 to 11 of the program counter
E	E register	PCm	Bits 4 to 7 of the program counter
CF	Carry flag	PCI	Bits 0 to 3 of the program counter
ZF	Zero flag	F _n	User flags, n = 0 to 15
HL	Data pointer DP _H and DP _L	TIMER0	Timer 0
XY	Data pointer DP _X and DP _Y	TIMER1	Timer 1
M	Data memory	SIO	Serial port register
M (HL)	Data memory pointed to by DP _{HL}	P	Port
M (XY)	Data memory pointed to by DP _{XY}	P (i4)	Port specified by 4-bit immediate data
M2 (HL)	Two-word location of data memory at even address pointed to by DP _{HL}	INT	Interrupt enable flag
SP	Stack pointer	(), []	Contents
M2 (SP)	Two-word location of data memory pointed to by SP	←	Direction of transfer, result
M4 (SP)	Four-word location of data memory pointed to by SP	⊕	Logical exclusive-OR
in	n-bit immediate data	.	Logical AND
t2	Bit specifier	+	Logical OR
	t2 Bit	+	Arithmetic addition
	00 0	-	Arithmetic subtraction
	01 1		
	10 2		
	11 3		

Mnemonic	Operation	Instruction code								Cycles	Notation	Description	Status flags
		D7	D6	D5	D4	D3	D2	D1	D0				
Accumulator instructions													
CLA	Clear AC	1	0	0	0	0	0	0	0	1	AC ← 0 (equivalent to LAI 0)	Clears the contents of the accumulator. Vertical skip function available	ZF
DAA	Decimal adjust AC after addition	1	0	0	0	1	1	1	1	2	AC ← (AC) + 6 (equivalent to ADI 6)	Adds 6 to the contents of the accumulator	ZF
DAS	Decimal adjust AC after subtraction	1	1	0	0	1	1	1	1	2	AC ← (AC) + 10 (equivalent to ADI 0H)	Adds 10 to the contents of the accumulator	ZF
CLC	Clear CF	0	0	0	1	1	1	1	0	1	CF ← 0	Clears the carry flag	CF
STC	Set CF	0	0	0	1	1	1	1	1	1	CF ← 1	Sets the carry flag	CF
CMA	Complement AC	0	0	0	1	1	0	0	0	1	AC ← $\overline{(AC)}$	Takes the 1s complement of the contents of the accumulator	ZF
IA	Increment AC	0	0	0	1	0	1	0	0	1	AC ← (AC) + 1	Increments the contents of the accumulator by 1	ZF, CF
DA	Decrement AC	0	0	1	0	0	1	0	0	1	AC ← (AC) - 1	Decrements the contents of the accumulator by 1	ZF, CF

LC66562A, LC66566A

Mnemonic	Operation	Instruction code								Cycles	Notation	Description	Status flags
		D7	D6	D5	D4	D3	D2	D1	D0				
RAR	Rotate AC right through CF	0	0	0	1	0	0	0	0	1	$AC_3 \leftarrow (CF)$ $AC_n \leftarrow (AC_n + 1)$ $CF \leftarrow (AC_0)$	Shifts the contents of the accumulator right through the carry flag	CF
RAL	Rotate AC left through CF	0	0	0	0	0	0	0	1	1	$AC_0 \leftarrow (CF)$ $AC_n + 1 \leftarrow (AC_n)$ $CF \leftarrow (AC_3)$	Shifts the contents of the accumulator left through the carry flag	CF, ZF
TAE	Transfer AC to E	0	1	0	0	0	1	0	1	1	$E \leftarrow (AC)$	Copies the contents of the accumulator into register E	
TEA	Transfer E to AC	0	1	0	0	0	1	1	0	1	$AC \leftarrow (E)$	Copies the contents of register E into the accumulator	ZF
XAE	Exchange AC with E	0	1	0	0	0	1	0	0	1	$(AC) \leftrightarrow (E)$	Exchanges the contents of the accumulator and register E	
Memory Instructions													
IM	Increment M	0	0	0	1	0	0	1	0	1	$M(HL) \leftarrow [M(HL)] + 1$	Increments the contents of memory location HL by 1	ZF, CF
DM	Decrement M	0	0	1	0	0	0	1	0	1	$M(HL) \leftarrow [M(HL)] - 1$	Decrements the contents of memory location HL by 1	ZF, CF
IMDR i8	Increment M direct	1	1	0	0	0	1	1	1	2	$M(i8) \leftarrow [M(i8)] + 1$	Increments the contents of the memory location specified by immediate data i0 to i7 by 1	ZF, CF
DMDR i8	Decrement M direct	1	1	0	0	0	0	1	1	2	$M(i8) \leftarrow [M(i8)] - 1$	Decrements the contents of the memory location specified by immediate data i0 to i7 by 1	ZF, CF
SMB i2	Set M data bit	0	0	0	0	1	1	i1	i0	1	$(M(HL), i2) \leftarrow 1$	Sets the bit in memory location HL specified by i0 and i1	
RMB i2	Reset M data bit	0	0	1	0	1	1	i1	i0	1	$(M(HL), i2) \leftarrow 0$	Clears the bit in memory location HL specified by i0 and i1	ZF
Arithmetic Instructions													
AD	Add M to AC	0	0	0	0	0	1	1	0	1	$AC \leftarrow (AC) + [M(HL)]$	Adds the contents of memory location HL to the contents of the accumulator and stores the result in the accumulator	ZF, CF
ADDR i8	Add M direct to AC	1	1	0	0	1	0	0	i0	2	$AC \leftarrow (AC) + [M(i8)]$	Adds the contents of the memory location specified by immediate data i0 to i7 to the contents of the accumulator and stores the result in the accumulator	ZF, CF
ADC	Add M to AC with CF	0	0	0	0	0	0	0	0	1	$AC \leftarrow (AC) + [M(HL)] + (CF)$	Adds the contents of memory location HL to the contents of the accumulator with carry and stores the result in the accumulator	ZF, CF
ADI i4	Add immediate data to AC	1	1	0	0	1	1	1	i0	2	$AC \leftarrow (AC) + i3 i2 i1 i0$	Adds immediate data i0 to i3 to the contents of the accumulator and stores the result in the accumulator	ZF
SUBC	Subtract AC from M with CF	0	0	0	1	0	1	1	1	1	$AC \leftarrow [M(HL)] - (AC) - \overline{(CF)}$	Subtracts the contents of the accumulator from the contents of memory location HL with carry and stores the result in the accumulator	ZF, CF
ANDA	AND M with AC then store in AC	0	0	0	0	0	1	1	1	1	$AC \leftarrow (AC) \cdot [M(HL)]$	Takes the logical AND of the contents of the accumulator with the contents of memory location HL and stores the result in the accumulator	ZF
ORA	OR M with AC then store in AC	0	0	0	0	0	1	0	1	1	$AC \leftarrow (AC) + [M(HL)]$	Takes the logical OR of the contents of the accumulator with the contents of memory location HL and stores the result in the accumulator	ZF
EXL	Exclusive-OR M with AC then store in AC	0	0	0	1	0	1	0	1	1	$AC \leftarrow (AC) \oplus [M(HL)]$	Takes the logical exclusive-OR of the contents of the accumulator with the contents of memory location HL and stores the result in the accumulator	ZF
ANDM	AND M with AC then store in M	0	0	0	0	0	0	1	1	1	$M(HL) \leftarrow (AC) \cdot [M(HL)]$	Takes the logical AND of the contents of the accumulator with the contents of memory location HL and stores the result in the accumulator	ZF
ORM	OR M with AC then store in M	0	0	0	0	0	1	0	0	1	$M(HL) \leftarrow (AC) + [M(HL)]$	Takes the logical OR of the contents of the accumulator with the contents of memory location HL and stores the result in memory location HL	ZF

LC66562A, LC66566A

Mnemonic	Operation	Instruction code								Cycles	Notation	Description	Status flags
		D7	D6	D5	D4	D3	D2	D1	D0				
CM	Compare AC with M	0	0	0	1	0	1	1	0	1	$\overline{M(HL)} - (AC) - 1$	Compares the contents of the accumulator with the contents of memory location HL and sets the condition flags as shown below	ZF, CF
		Comparison		CF	ZF								
		[M(HL)] > (AC)		0	0								
		[M(HL)] = (AC)		1	1								
		[M(HL)] < (AC)		1	0								
CI i4	Compare AC with immediate data	1	1	0	0	1	1	1	1	2	$\overline{I_3 I_2 I_1 I_0} - (AC) - 1$	Compares the contents of the accumulator with immediate data I ₀ to I ₃ and sets the condition flags as shown below	ZF, CF
		Comparison		CF	ZF								
		I ₃ I ₂ I ₁ I ₀ > (AC)		0	0								
		I ₃ I ₂ I ₁ I ₀ = (AC)		1	1								
		I ₃ I ₂ I ₁ I ₀ < (AC)		1	0								
CLI i4	Compare DPL with immediate data	1	1	0	0	1	1	1	1	2	ZF ← 1 if (DPL) = I ₃ I ₂ I ₁ I ₀ ZF ← 0 if (DPL) ≠ I ₃ I ₂ I ₁ I ₀	Compares the contents of the lower nibble of data pointer HL with immediate data I ₀ to I ₃ . Sets the zero flag when equal and clears the zero flag when unequal	ZF
CMB i2	Compare AC bit with M data bit	1	1	0	0	1	1	1	1	2	ZF ← 1 if (AC, i2) = [M(HL), i2] ZF ← 0 if (AC, i2) ≠ [M(HL), i2]	Compares the bit of the accumulator specified by i ₀ and i ₁ with the bit of memory location HL specified by i ₀ and i ₁ . Sets the zero flag when equal and clears the zero flag when unequal	ZF
Load and store instructions													
LAE	Load AC and E from M2[HL]	0	1	0	1	1	1	0	0	1	AC ← M(HL), E ← M(HL + 1)	Loads the contents of memory location HL into the accumulator, and the contents of memory location HL + 1, into register E	
LAI i4	Load AC with immediate data	1	0	0	0	I ₃	I ₂	I ₁	I ₀		AC ← I ₃ I ₂ I ₁ I ₀	Loads immediate data I ₀ to I ₃ into the accumulator. Vertical skip function available	ZF
LADR i8	Load AC from M direct	1	1	0	0	0	0	0	1	2	AC ← [M(i8)]	Loads the contents of the memory location specified by immediate data I ₀ to I ₇ into the accumulator	ZF
S	Store AC to M	0	1	0	0	0	1	1	1	1	M(HL) ← (AC)	Stores the contents of the accumulator in memory location HL	
SAE	Store AC and E to M2[HL]	0	1	0	1	1	1	1	0	1	M(HL) ← (AC), M(HL + 1) ← (E)	Stores the contents of the accumulator in memory location HL, and the contents of register E, in memory location HL + 1	
LA reg	Load AC from M(reg)	0	1	0	0	1	0	I ₀	0	1	AC ← [M(reg)]	Loads the contents of the memory location specified by I ₀ into the accumulator	ZF
		Register		I ₀									
		HL		0									
		XY		1									
LA i9g	Load AC from M(i9g) then increment reg	0	1	0	0	1	0	I ₀	1	2	AC ← [M(i9g)], DPL ← (DPL) + 1 or DPY ← (DPY) + 1	Loads the contents of the memory location specified by I ₀ into the accumulator and increments the lower nibble of the corresponding memory location data pointer.	ZF
		Register		I ₀									
		HL		0									
		XY		1									
		The zero flag is set according to the data pointer increment operation.											

LC66562A, LC66566A

Mnemonic	Operation	Instruction code								Cycles	Notation	Description	Status flags						
		D7	D6	D5	D4	D3	D2	D1	D0										
LA reg. D	Load AC from M(reg) then decrement reg	0	1	0	1	1	0	to	1	2	$AC \leftarrow [M(\text{reg})]$ $DPL \leftarrow (DPL) - 1$ or $DPY \leftarrow (DPY) - 1$	<p>Loads the contents of the memory location specified by I_0 into the accumulator and decrements the lower nibble of the corresponding memory location data pointer.</p> <table border="1"> <tr> <th>Register</th> <th>I_0</th> </tr> <tr> <td>HL</td> <td>0</td> </tr> <tr> <td>XY</td> <td>1</td> </tr> </table> <p>The zero flag is set according to the data pointer decrement operation.</p>	Register	I_0	HL	0	XY	1	ZF
Register	I_0																		
HL	0																		
XY	1																		
XA reg	Exchange AC with M(reg)	0	1	0	0	1	1	to	0	1	$(AC) \leftrightarrow [M(\text{reg})]$	<p>Exchanges the contents of the accumulator with the contents of the memory location specified by I_0.</p> <table border="1"> <tr> <th>Register</th> <th>I_0</th> </tr> <tr> <td>HL</td> <td>0</td> </tr> <tr> <td>XY</td> <td>1</td> </tr> </table>	Register	I_0	HL	0	XY	1	
Register	I_0																		
HL	0																		
XY	1																		
XA reg. I	Exchange AC with M(reg) then increment reg	0	1	0	0	1	1	to	1	2	$(AC) \leftrightarrow [M(\text{reg})]$ $DPL \leftarrow (DPL) + 1$ or $DPY \leftarrow (DPY) + 1$	<p>Exchanges the contents of the accumulator with the contents of the memory location specified by I_0 and increments the lower nibble of the corresponding memory location data pointer.</p> <table border="1"> <tr> <th>Register</th> <th>I_0</th> </tr> <tr> <td>HL</td> <td>0</td> </tr> <tr> <td>XY</td> <td>1</td> </tr> </table> <p>The zero flag is set according to the data pointer increment operation.</p>	Register	I_0	HL	0	XY	1	ZF
Register	I_0																		
HL	0																		
XY	1																		
XA reg. D	Exchange AC with M(reg) then decrement reg	0	1	0	1	1	1	to	1	2	$(AC) \leftrightarrow [M(\text{reg})]$ $DPL \leftarrow (DPL) - 1$ or $DPY \leftarrow (DPY) - 1$	<p>Exchanges the contents of the accumulator with the contents of the memory location specified by I_0 and decrements the lower nibble of the corresponding memory location data pointer.</p> <table border="1"> <tr> <th>Register</th> <th>I_0</th> </tr> <tr> <td>HL</td> <td>0</td> </tr> <tr> <td>XY</td> <td>1</td> </tr> </table> <p>The zero flag is set according to the data pointer decrement operation.</p>	Register	I_0	HL	0	XY	1	ZF
Register	I_0																		
HL	0																		
XY	1																		
XADR i8	Exchange AC with M direct	1	1	0	0	1	0	0	0	2	$(AC) \leftrightarrow [M(i8)]$	Exchanges the contents of the accumulator with the contents of the memory location specified by immediate data I_0 to I_7							
LEAI i8	Load E and AC with immediate data	1	1	0	0	0	1	1	0	2	$E \leftarrow I_7 I_6 I_5 I_4$ $AC \leftarrow I_3 I_2 I_1 I_0$	Loads immediate data I_4 to I_7 into register E, and immediate data I_0 to I_3 into the accumulator							
RTBL	Read table data from program ROM	0	1	0	1	1	0	1	0	2	$E, AC \leftarrow [ROM(PCh, E, AC)]$	Loads the upper nibble of the memory location specified by the program counter (the lower 8 bits are replaced by the contents of register E and the accumulator) into register E, and the upper nibble, into the accumulator							
RTBLP	Read table data from program ROM then output to P4 and P5	0	1	0	1	1	0	0	0	2	Ports 4 and 5 $\leftarrow [ROM(PCh, E, AC)]$	Loads the upper nibble of the memory location specified by the program counter (the lower 8 bits are replaced by the contents of register E and the accumulator) into port P4, and the upper nibble, into port P5							
Data pointer instructions																			
LDZ i4	Load DPH with zero and DPL with immediate data	0	1	1	0	I_3	I_2	I_1	I_0	1	$DPH \leftarrow 0, DPL \leftarrow I_3 I_2 I_1 I_0$	Clears the contents of the upper nibble of data pointer DP_{HL} and loads immediate data I_0 to I_3 into the lower nibble of data pointer DP_{HL}							
LHI i4	Load DPH with immediate data	1	0	0	0	I_3	I_2	I_1	I_0	2	$DPH \leftarrow I_3 I_2 I_1 I_0$	Loads immediate data I_0 to I_3 into the upper nibble of data pointer DP_{HL}							
LLI i4	Load DPL with immediate data	1	0	0	1	I_3	I_2	I_1	I_0	2	$DPL \leftarrow I_3 I_2 I_1 I_0$	Loads immediate data I_0 to I_3 into the lower nibble of data pointer DP_{HL}							
LHLI i8	Load DPH, DPL with immediate data	1	1	0	0	I_3	I_2	I_1	I_0	2	$DPH \leftarrow I_7 I_6 I_5 I_4$ $DPL \leftarrow I_3 I_2 I_1 I_0$	Loads immediate data I_0 to I_7 into the data pointer DP_{HL}							
LXYI i8	Load DPX, DPY with immediate data	1	1	0	0	I_3	I_2	I_1	I_0	2	$DPX \leftarrow I_7 I_6 I_5 I_4$ $DPY \leftarrow I_3 I_2 I_1 I_0$	Loads immediate data I_0 to I_7 into the auxiliary data pointer DP_{XY}							

LC66562A, LC66566A

Mnemonic	Operation	Instruction code								Cycles	Notation	Description	Status flags
		D7	D6	D5	D4	D3	D2	D1	D0				
IL	Increment DPL	0	0	0	1	0	0	0	1	1	$DPL \leftarrow (DPL) + 1$	Increases the contents of the lower nibble of data pointer DPH _L by 1	ZF
DL	Decrement DPL	0	0	1	0	0	0	0	1	1	$DPL \leftarrow (DPL) - 1$	Decrements the contents of the lower nibble of data pointer DPH _L by 1	ZF
IY	Increment DPY	0	0	0	1	0	0	1	1	1	$DPY \leftarrow (DPY) + 1$	Increases the contents of the lower nibble of auxiliary data pointer DPXY	ZF
DY	Decrement DPY	0	0	1	0	0	0	1	1	1	$DPY \leftarrow (DPY) - 1$	Decrements the contents of the lower nibble of auxiliary data pointer DPXY	ZF
TAH	Transfer AC to DPH	1	1	0	0	1	1	1	1	2	$DPH \leftarrow (AC)$	Copies the contents of the accumulator into the upper nibble of data pointer DPH _L	
THA	Transfer DPH to AC	1	1	0	0	1	1	1	1	2	$AC \leftarrow (DPH)$	Copies the contents of the upper nibble of data pointer DPH _L into the accumulator	ZF
XAH	Exchange AC with DPH	0	1	0	0	0	0	0	0	1	$(AC) \leftrightarrow (DPH)$	Exchanges the contents of the accumulator with the contents of the upper nibble of data pointer DPH _L	
TAL	Transfer AC to DPL	1	1	0	0	1	1	1	1	2	$DPL \leftarrow (AC)$	Copies the contents of the lower nibble of data pointer DPH _L into the accumulator	
TLA	Transfer DPL to AC	1	1	0	0	1	1	1	1	2	$AC \leftarrow (DPL)$	Copies the contents of the accumulator into the lower nibble of data pointer DPH _L	ZF
XAL	Exchange AC with DPL	0	1	0	0	0	0	0	1	1	$(AC) \leftrightarrow (DPL)$	Exchanges the contents of the accumulator with the contents of the lower nibble of data pointer DPH _L	
TAX	Transfer AC to DPX	1	1	0	0	1	1	1	1	2	$DPX \leftarrow (AC)$	Copies the contents of the accumulator into the upper nibble of auxiliary data pointer DPXY	
TXA	Transfer DPX to AC	1	1	0	0	1	1	1	1	2	$AC \leftarrow (DPX)$	Copies the contents of the upper nibble of auxiliary data pointer DPXY into the accumulator	ZF
XAX	Exchange AC with DPX	0	1	0	0	0	0	1	0	1	$(AC) \leftrightarrow (DPX)$	Exchanges the contents of the accumulator with the contents of the upper nibble of auxiliary data pointer DPXY	
TAY	Transfer AC to DPY	1	1	0	0	1	1	1	1	2	$DPY \leftarrow (AC)$	Copies the contents of the accumulator into the lower nibble of auxiliary data pointer DPXY	
TYA	Transfer DPY to AC	1	1	0	0	1	1	1	1	2	$AC \leftarrow (DPY)$	Copies the contents of the lower nibble of auxiliary data pointer DPXY into the accumulator	ZF
XAY	Exchange AC with DPY	0	1	0	0	0	0	1	1	1	$(AC) \leftrightarrow (DPY)$	Exchanges the contents of the accumulator with the contents of the lower nibble of auxiliary data pointer DPXY	
Flag instructions													
SFB n4	Set flag bit	0	1	1	1	n	n	n	n	1	$F_n \leftarrow 1$	Sets the flag specified by n ₀ to n ₃	
RFB n4	Reset flag bit	0	0	1	1	n	n	n	n	1	$F_n \leftarrow 0$	Clears the flag specified by n ₀ to n ₃	ZF
Jump and call instructions													
JMP addr	Jump in the current bank	1	1	1	0	P	P	P	P	2	$PC_{13, 12} \leftarrow PC_{13, 12}$, $PC_{11} \text{ to } 0 \leftarrow P_{11} \text{ to } P_0$	Jumps within the same bank to the address specified by the program counter (the lower 12 bits are replaced by immediate data P ₀ to P ₁₁). After a bank instruction, PC ₁₂ is complemented.	
JPEA	Jump to the address stored at E and AC in the current page	0	0	1	0	0	1	1	1	1	$PC_{13, 12} \text{ to } PC_8 \leftarrow PC_{13, 12} \text{ to } PC_8$, $PC_7 \text{ to } 4 \leftarrow (E)$, $PC_3 \text{ to } 0 \leftarrow (AC)$	Jumps within the current page to the address specified by the program counter (the lower 8 bits are replaced by the contents of register E and the accumulator)	
CAL addr	Call subroutine	0	1	0	1	0	P	P	P	2	$PC_{13} \text{ and } 11 \leftarrow 0$, $PC_{10} \text{ to } 0 \leftarrow P_{10} \text{ to } P_0$, $M(SP) \leftarrow (CF, ZF, PC_{13} \text{ to } 0)$, $SP \leftarrow (SP) - 4$	Calls a subroutine at the address specified by P ₀ to P ₁₀	
CZP addr	Call subroutine in the zero page	1	0	1	0	P	P	P	P	2	$PC_{13} \text{ to } 6, PC_1 \text{ to } 0 \leftarrow 0$, $PC_5 \text{ to } 2 \leftarrow P_3 \text{ to } P_0$, $M(SP) \leftarrow (CF, ZF, PC_{12} \text{ to } 0)$, $SP \leftarrow SP - 4$	Calls a subroutine within page 0 of bank 0 at the address specified by P ₀ to P ₃	
BANK	Change bank	0	0	0	1	1	0	1	1	1		Changes memory bank or register bank	

LC66562A, LC66566A

Mnemonic	Operation	Instruction code								Cycles	Notation	Description	Status flags															
		D7	D6	D5	D4	D3	D2	D1	D0																			
PUSH reg	Push reg on M2(SP)	1	1	0	0	1	1	1	1	2	$M2(SP) \leftarrow (reg),$ $SP \leftarrow (SP) - 2$	Pushes the contents of the register specified by i0 and i1 onto the stack and decrements the stack pointer by 2.																
		1	1	1	1	1	1	1	1			<table border="1"> <thead> <tr> <th>Register</th> <th>i1</th> <th>i0</th> </tr> </thead> <tbody> <tr> <td>HL</td> <td>0</td> <td>0</td> </tr> <tr> <td>XY</td> <td>0</td> <td>1</td> </tr> <tr> <td>AE</td> <td>1</td> <td>0</td> </tr> <tr> <td>Illegal</td> <td>1</td> <td>1</td> </tr> </tbody> </table>	Register	i1	i0	HL	0	0	XY	0	1	AE	1	0	Illegal	1	1	
Register	i1	i0																										
HL	0	0																										
XY	0	1																										
AE	1	0																										
Illegal	1	1																										
POP reg	Pop reg off M2(SP)	1	1	0	0	1	1	1	1	2	$SP \leftarrow (SP) + 2,$ $reg \leftarrow [M2(SP)]$	Increments the stack pointer by 2, pops the contents off the stack and moves the contents into the register specified by i0 and i1.																
		1	1	1	0	1	1	1	1			<table border="1"> <thead> <tr> <th>Register</th> <th>i1</th> <th>i0</th> </tr> </thead> <tbody> <tr> <td>HL</td> <td>0</td> <td>0</td> </tr> <tr> <td>XY</td> <td>0</td> <td>1</td> </tr> <tr> <td>AE</td> <td>1</td> <td>0</td> </tr> <tr> <td>Illegal</td> <td>1</td> <td>1</td> </tr> </tbody> </table>	Register	i1	i0	HL	0	0	XY	0	1	AE	1	0	Illegal	1	1	
Register	i1	i0																										
HL	0	0																										
XY	0	1																										
AE	1	0																										
Illegal	1	1																										
RT	Return from subroutine	0	0	0	1	1	1	0	0	2	$SP \leftarrow (SP) + 4,$ $PC \leftarrow [M4(SP)]$	Returns from a subroutine or an interrupt service routine, but does not restore the state of the zero and carry flags.																
RTI	Return from interrupt subroutine	0	0	0	1	1	1	0	1	2	$SP \leftarrow (SP) + 4,$ $PC \leftarrow [M4(SP)], CF,$ $ZF \leftarrow [M4(SP)]$	Returns from a subroutine or an interrupt service routine, including the state of the zero and carry flags.	ZF, CF															
Branch Instructions																												
BAI2 addr	Branch on AC bit	1	1	0	1	0	0	1	1	2	$PC7 \text{ to } 0 \leftarrow P7 P6 P5 P4 P3$ $P2 P1 P0 \text{ if } (AC, I2) = 1$	Tests the bit specified by immediate data i0 and i1 of the accumulator and, if set, branches within the same page to the address specified by P0 to P7.																
		1	1	1	1	0	0	1	1																			
BNAI2 addr	Branch on no AC bit	1	0	0	1	0	0	1	1	2	$PC7 \text{ to } 0 \leftarrow P7 P6 P5 P4 P3$ $P2 P1 P0 \text{ if } (AC, I2) = 0$	Tests the bit specified by immediate data i0 and i1 of the accumulator and, if not set, branches within the same page to the address specified by P0 to P7.																
		1	0	1	1	0	0	1	1																			
SMI2 addr	Branch on M bit	1	1	0	1	0	1	1	1	2	$PC7 \text{ to } 0 \leftarrow P7 P6 P5 P4 P3$ $P2 P1 P0 \text{ if } [M(HL), I2] = 1$	Tests the bit specified by immediate data i0 and i1 of memory location HL and, if set, branches within the same page to the address specified by P0 to P7.																
		1	1	1	1	0	1	1	1																			
BNMI2 addr	Branch on no M bit	1	0	0	1	0	1	1	1	2	$PC7 \text{ to } 0 \leftarrow P7 P6 P5 P4 P3$ $P2 P1 P0 \text{ if } [M(HL), I2] = 0$	Tests the bit specified by immediate data i0 and i1 of memory location HL and, if not set, branches within the same page to the address specified by P0 to P7.																
		1	0	1	1	0	1	1	1																			
BPI2 addr	Branch on port bit	1	1	0	1	1	0	1	1	2	$PC7 \text{ to } 0 \leftarrow P7 P6 P5 P4 P3$ $P2 P1 P0 \text{ if } [P(DPL), I2] = 1$	Tests the bit specified by immediate data i0 and i1 of the port specified by the contents of the lower nibble of data pointer DPHL and, if set, branches within the same page to the address specified by P0 to P7. When followed by bank instructions, the internal control registers are also valid (read-only registers).																
		1	1	1	1	0	1	1	1																			
BNPI2 addr	Branch on no port bit	1	0	0	1	1	0	1	1	2	$PC7 \text{ to } 0 \leftarrow P7 P6 P5 P4 P3$ $P2 P1 P0 \text{ if } [P(DPL), I2] = 0$	Tests the bit specified by immediate data i0 and i1 of the port specified by the contents of the lower nibble of data pointer DPHL and, if not set, branches within the same page to the address specified by P0 to P7. When followed by bank instructions, the internal control registers are also valid (read-only registers).																
		1	0	1	1	0	1	1	1																			
BC addr	Branch on CF	1	1	0	1	1	1	0	0	2	$PC7 \text{ to } 0 \leftarrow P7 P6 P5 P4 P3$ $P2 P1 P0 \text{ if } (CF) = 1$	Tests the carry flag and, if set, branches within the same page to the address specified by P0 to P7.																
		1	1	1	1	0	1	0	0																			
BNC addr	Branch on no CF	1	0	0	1	1	1	0	0	2	$PC7 \text{ to } 0 \leftarrow P7 P6 P5 P4 P3$ $P2 P1 P0 \text{ if } (CF) = 0$	Tests the carry flag and, if not set, branches within the same page to the address specified by P0 to P7.																
		1	0	1	1	1	1	0	0																			
BZ addr	Branch on ZF	1	1	0	1	1	1	0	1	2	$PC7 \text{ to } 0 \leftarrow P7 P6 P5 P4 P3$ $P2 P1 P0 \text{ if } (ZF) = 1$	Tests the zero flag and, if set, branches within the same page to the address specified by P0 to P7.																
		1	1	1	1	0	1	0	1																			
BNZ addr	Branch on no ZF	1	0	0	1	1	1	0	1	2	$PC7 \text{ to } 0 \leftarrow P7 P6 P5 P4 P3$ $P2 P1 P0 \text{ if } (ZF) = 0$	Tests the zero flag and, if not set, branches within the same page to the address specified by P0 to P7.																
		1	0	1	1	1	1	0	1																			

LC66562A, LC66566A

Mnemonic	Operation	Instruction code								Cycles	Notation	Description	Status flags
		D7	D6	D5	D4	D3	D2	D1	D0				
BFn4 addr	Branch on flag bit	1 P 7	1 P 6	1 P 5	1 P 4	n 3 P 3	n 2 P 2	n 1 P 1	n 0 P 0	2	PC7 to 0 ← P7 P6 P5 P4 P3 P2 P1 P0 if (Fn) = 1	Tests the flag specified by n0 to n3 and, if set, branches within the same page to the address specified by P0 to P7	
BNFn4 addr	Branch on no flag bit	1 P 7	0 P 6	1 P 5	1 P 4	n 3 P 3	n 2 P 2	n 1 P 1	n 0 P 0	2	PC7 to 0 ← P7 P6 P5 P4 P3 P2 P1 P0 if (Fn) = 0	Tests the flag specified by n0 to n3 and, if not set, branches within the same page to the address specified by P0 to P7	
Input and output instructions													
IPO	Input port 0 to AC	0	0	1	0	0	0	0	0	1	AC ← (P0)	Loads the contents of input port P0 into the accumulator	ZF
IP	Input port to AC	0	0	1	0	0	1	1	0	1	AC ← [P(DPL)]	Loads the contents of the input port specified by the contents of the lower nibble of data pointer DPHL into the accumulator	ZF
IPM	Input port to M	0	0	0	1	1	0	0	1	1	M(HL) ← [P(DPL)]	Loads the contents of the input port specified by the contents of the lower nibble of data pointer DPHL into memory location HL	
IPDR i4	Input port to AC direct	1 0	1 1	0 1	0 0	1 i3	1 i2	1 i1	1 i0	2	AC ← [P(i4)]	Loads the contents of the input port specified by immediate data i0 to i3 into the accumulator	ZF
IP45	Input ports 4 and 5 to E and AC, respectively	1 1	1 1	0 0	0 1	1 0	1 1	1 0	1 0	2	E ← [P(4)] AC ← [P(5)]	Loads the contents of input ports P4 and P5 into register E and the accumulator, respectively	
OP	Output AC to port	0	0	1	0	0	1	0	1	1	P(DPL) ← (AC)	Loads the contents of the accumulator into the output port specified by the contents of the lower nibble of data pointer DPHL	
OPM	Output M to port	0	0	0	1	1	0	1	0	1	P(DPL) ← [M(HL)]	Loads the contents of memory location HL into the output port specified by the lower nibble of data pointer DPHL	
OPDR i4	Output AC to port direct	1 0	1 1	0 1	0 1	1 i3	1 i2	1 i1	1 i0	2	P(i4) ← (AC)	Loads the contents of the accumulator into the output port specified by immediate data i0 to i3	
OP45	Output E and AC to ports 4 and 5, respectively	1 1	1 1	0 0	0 1	1 0	1 1	1 0	1 1	2	P(4) ← (E) P(5) ← (AC)	Loads the contents of register E and the accumulator into ports P4 and P5, respectively	
SPB i2	Set port bit	0	0	0	0	1	0	1	i0	1	[P(DPL), i2] ← 1	Sets the bit specified by immediate data i0 and i1 of the output port specified by the lower nibble of data pointer DPHL	
RPB i2	Reset port bit	0	0	1	0	1	0	1	i0	1	[P(DPL), i2] ← 0	Clears the bit specified by immediate data i0 and i1 of the output port specified by the lower nibble of data pointer DPHL	ZF
ANDPDR i4, p4	AND port with immediate data then output	1 i3	1 i2	0 i1	0 i0	0 p3	1 p2	0 p1	1 p0	2	P(P3 to P0) ← [P(P3 to 0)] + i3 to 0	Takes the logical AND of the contents of the port specified by P0 to P3 with immediate data i0 to i3 and loads the result into the port	ZF
ORPDR i4, p4	OR port with immediate data then output	1 i3	1 i2	0 i1	0 i0	0 p3	1 p2	0 p1	1 p0	2	P(P3 to P0) ← [P(P3 to 0)] + i3 to 0	Takes the logical OR of the contents of the port specified by P0 to P3 with immediate data i0 to i3 and loads the result into the port	ZF
Timer control instructions													
WTTM0	Write timer 0	1	1	0	0	1	0	1	0	2	TIMER0 ← [M2(HL)] and (AC)	Writes the contents of memory locations HL and HL + 1 and the contents of the accumulator into the timer 0 reload register	
WTTM1	Write timer 1	1	1	0	0	1	1	1	0	2	TIMER1 ← (E) and (AC)	Writes the contents of register E and the accumulator into the timer 0 reload register	
RTIM0	Read timer 0	1	1	0	0	1	0	1	1	2	M2(HL) and AC ← (TIMER0)	Reads the contents of the timer 0 counter into memory locations HL and HL + 1 and the accumulator	
RTIM1	Read timer 1	1	1	0	0	1	1	1	1	2	E and AC ← (TIMER1)	Reads the contents of the timer 1 counter into register E and the accumulator	
START0	Start timer 0	1	1	0	0	0	1	1	1	2	Start timer 0 counter	Starts the timer 0 counter	
START1	Start timer 1	1	1	0	0	0	1	1	1	2	Start timer 1 counter	Starts the timer 1 counter	
STOP0	Stop timer 0	1	1	0	0	1	1	1	1	2	Stop timer 0 counter	Stops the timer 0 counter	
STOP1	Stop timer 1	1	1	0	0	1	1	1	1	2	Stop timer 1 counter	Stops the timer 1 counter	

LC66562A, LC66566A

Mnemonic	Operation	Instruction code								Cycles	Notation	Description	Status flags
		D7	D6	D5	D4	D3	D2	D1	D0				
Interrupt control instructions													
MSET	Set Interrupt Master Enable flag	1	1	0	0	1	1	0	1	2	$MSE \leftarrow 1$	Sets the interrupt master enable flag	
MRESET	Reset Interrupt Master Enable flag	1	1	0	0	1	1	0	1	2	$MSE \leftarrow 0$	Clears the interrupt master enable flag	
EIH i4	Enable interrupt HIGH	1	1	0	0	1	1	0	1	2	$EDIH \leftarrow (EDIH) + i4$	Takes the logical OR of the interrupt mask with immediate data i0 to i3 and, for bits that are set, enables the corresponding active-HIGH interrupts	
EIL i4	Enable interrupt LOW	1	1	0	0	1	1	0	1	2	$EDIL \leftarrow (EDIL) + i4$	Takes the logical OR of the interrupt mask with immediate data i0 to i3 and, for bits that are set, enables the corresponding active-LOW interrupts	
DIH i4	Disable interrupt HIGH	1	1	0	0	1	1	0	1	2	$EDIH \leftarrow (EDIH) \cdot \bar{i4}$	Takes the logical AND of the interrupt mask with the 1s complement of immediate data i0 to i3 and, for bits that are set, disables the corresponding active-HIGH interrupts	ZF
DIL i4	Disable interrupt LOW	1	1	0	0	1	1	0	1	2	$EDIL \leftarrow (EDIL) \cdot \bar{i4}$	Takes the logical AND of the interrupt mask with the 1s complement of immediate data i0 to i3 and, for bits that are set, disables the corresponding active-LOW interrupts	ZF
WTSP	Write SP	1	1	0	0	1	1	1	1	2	$SP \leftarrow (E), (AC)$	Writes the contents of register E and the accumulator into the stack pointer	
RSP	Read SP	1	1	0	0	1	1	1	1	2	$E, AC \leftarrow (SP)$	Reads the contents of the stack pointer into register E and the accumulator	
Standby control instructions													
HALT	Halt	1	1	0	0	1	1	1	1	2	Halt	Selects halt mode	
HOLD	Hold	1	1	0	0	1	1	1	1	2	Hold	Selects hold mode	
Serial input/output control instructions													
STARTS	Start serial I/O	1	1	0	0	1	1	1	1	2	START, SIO	Starts serial input/output operation	
WTSIO	Write serial I/O	1	1	0	0	1	1	1	1	2	$SIO \leftarrow (E) \text{ and } (AC)$	Writes the contents of register E and the accumulator into the serial input/output port	
RSIO	Read serial I/O	1	1	0	0	1	1	1	1	2	$E \text{ and } AC \leftarrow (SIO)$	Reads the serial input/output port into register E and the accumulator	
Miscellaneous instructions													
NOP	No operation	0	0	0	0	0	0	0	0	1	No operation	No operation for one cycle	
SB i2	Select bank	1	1	0	0	1	1	1	1	2	$PC13, 12 \leftarrow i1, i0$	Selects the memory bank specified by immediate data i0 and i1	

- No products described or contained herein are intended for use in surgical implants, life-support systems, aerospace equipment, nuclear power control systems, vehicles, disaster/crime-prevention equipment and the like, the failure of which may directly or indirectly cause injury, death or property loss.
- Anyone purchasing any products described or contained herein for an above-mentioned use shall:
 - ① Accept full responsibility and indemnify and defend SANYO ELECTRIC CO., LTD., its affiliates, subsidiaries and distributors and all their officers and employees, jointly and severally, against any and all claims and litigation and all damages, cost and expenses associated with such use.
 - ② Not impose any responsibility for any fault or negligence which may be cited in any such claim or litigation on SANYO ELECTRIC CO., LTD., its affiliates, subsidiaries and distributors or any of their officers and employees, jointly or severally.
- Information (including circuit diagrams and circuit parameters) herein is for example only; it is not guaranteed for volume production. SANYO believes information herein is accurate and reliable, but no guarantees are made or implied regarding its use or any infringements of intellectual property rights or other rights of third parties.

This catalog provides information as of October, 1995. Specifications and information herein are subject to change without notice.