



## N-Channel Enhancement Mode Field Effect Transistor

PRODUCT SUMMARY		
V <sub>DSS</sub>	I <sub>D</sub>	R <sub>DS(ON)</sub> (mΩ) MAX
30V	7A	30 @ V <sub>GS</sub> = 10V
		50 @ V <sub>GS</sub> = 4.5V

### FEATURES

- Super high dense cell design for low R<sub>DS(ON)</sub>.
- Rugged and reliable.
- Surface Mount Package.



### ABSOLUTE MAXIMUM RATINGS (T<sub>A</sub>=25 °C unless otherwise noted)

Parameter	Symbol	Limit	Unit
Drain-Source Voltage	V <sub>DS</sub>	30	V
Gate-Source Voltage	V <sub>GS</sub>	±20	V
Drain Current-Continuous <sup>a</sup> @ T <sub>J</sub> =125 °C -Pulsed <sup>b</sup> (300ms Pulse Width)	I <sub>D</sub>	7	A
	I <sub>DM</sub>	28	A
Drain-Source Diode Forward Current <sup>a</sup>	I <sub>S</sub>	2.8	A
Maximum Power Dissipation <sup>a</sup>	P <sub>D</sub>	2.5	W
Operating Junction and Storage Temperature Range	T <sub>J</sub> , T <sub>STG</sub>	-55 to 150	°C

### THERMAL CHARACTERISTICS

Thermal Resistance, Junction-to-Ambient <sup>a</sup>	R <sub>θJA</sub>	50	°C/W
--	------------------	----	------

# S DM9410

ELECTRICAL CHARACTERISTICS ( $T_A=25^{\circ}\text{C}$  unless otherwise noted)

Parameter	Symbol	Condition	Min	Typ <sup>c</sup>	Max	Unit
<b>OFF CHARACTERISTICS</b>						
Drain-Source Breakdown Voltage	$BV_{DSS}$	$V_{GS}=0V, I_D=250\mu A$	30			V
Zero Gate Voltage Drain Current	$I_{DSS}$	$V_{DS}=24V, V_{GS}=0V$			1	$\mu A$
Gate-Body Leakage	$I_{GSS}$	$V_{GS} = \pm 20V, V_{DS} = 0V$			$\pm 100$	nA
<b>ON CHARACTERISTICS<sup>b</sup></b>						
Gate Threshold Voltage	$V_{GS(th)}$	$V_{DS}=V_{GS}, I_D = 250\mu A$	1	1.8	3	V
Drain-Source On-State Resistance	$R_{DS(ON)}$	$V_{GS} = 10V, I_D = 7A$			30	m ohm
		$V_{GS} = 4.5V, I_D = 3.5A$			50	m ohm
On-State Drain Current	$I_{D(ON)}$	$V_{DS} = 5V, V_{GS} = 10V$	30			A
Forward Transconductance	$g_{FS}$	$V_{DS} = 5V, I_D = 7A$		12		S
<b>DYNAMIC CHARACTERISTICS<sup>c</sup></b>						
Input Capacitance	$C_{ISS}$	$V_{DS} = 15V, V_{GS} = 0V$ $f = 1.0MHz$		510		pF
Output Capacitance	$C_{OSS}$			235		pF
Reverse Transfer Capacitance	$C_{RSS}$			56		pF
<b>SWITCHING CHARACTERISTICS<sup>c</sup></b>						
Turn-On Delay Time	$t_{D(ON)}$	$V_{DD} = 15V,$ $I_D = 1A,$ $V_{GS} = 10V,$ $R_{GEN} = 10 \text{ ohm}$		21	40	ns
Rise Time	$t_r$			20	40	ns
Turn-Off Delay Time	$t_{D(OFF)}$			27	55	ns
Fall Time	$t_f$			115	230	ns
Total Gate Charge	$Q_g$	$V_{DS} = 15V, I_D = 1A, V_{GS} = 10V$		13	20	nC
		$V_{DS} = 15V, I_D = 1A, V_{GS} = 4.5V$		6.5	10	nC
Gate-Source Charge	$Q_{gs}$	$V_{DS} = 15V, I_D = 1A,$ $V_{GS} = 10V$		2		nC
Gate-Drain Charge	$Q_{gd}$			2.3		nC

# SDM9410

## ELECTRICAL CHARACTERISTICS ( $T_A=25^\circ\text{C}$ unless otherwise noted)

Parameter	Symbol	Condition	Min	Typ <sup>c</sup>	Max	Unit
<b>DRAIN-SOURCE DIODE CHARACTERISTICS<sup>b</sup></b>						
Diode Forward Voltage	$V_{SD}$	$V_{GS} = 0V, I_s = 5.3A$		0.76	1.1	V

### Notes

- a. Surface Mounted on FR4 Board,  $t \leq 10\text{sec}$ .
- b. Pulse Test: Pulse Width  $\leq 300\mu\text{s}$ , Duty Cycle  $\leq 2\%$ .
- c. Guaranteed by design, not subject to production testing.

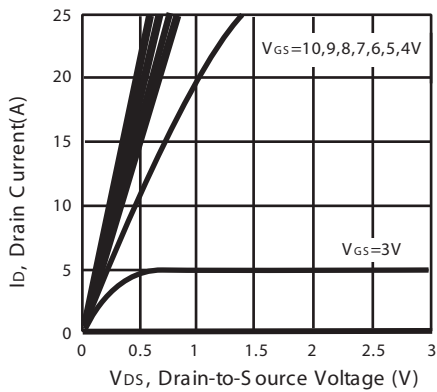

Figure 1. Output Characteristics

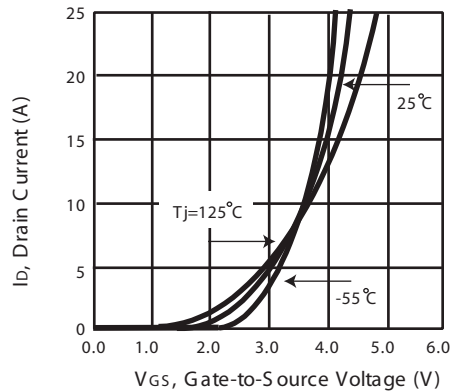

Figure 2. Transfer Characteristics

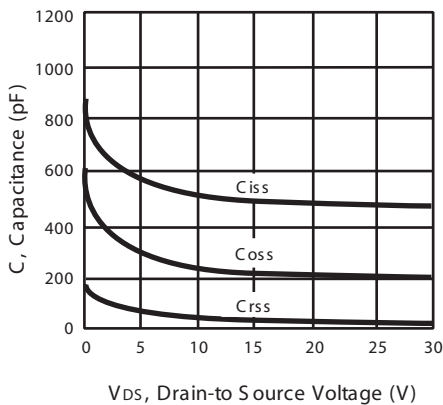

Figure 3. Capacitance

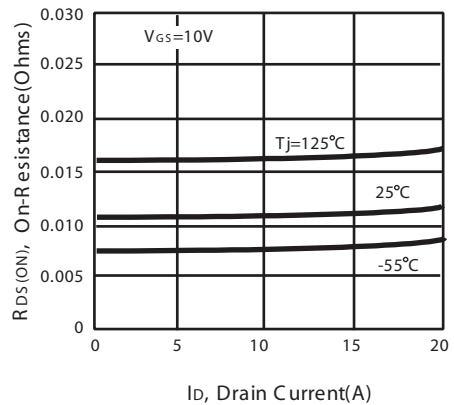

Figure 4. On-R Resistance Variation with Drain Current and Temperature

# S DM9410

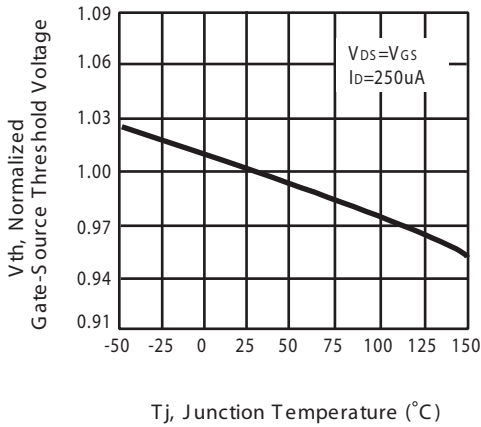

Figure 5. Gate Threshold Variation with Temperature

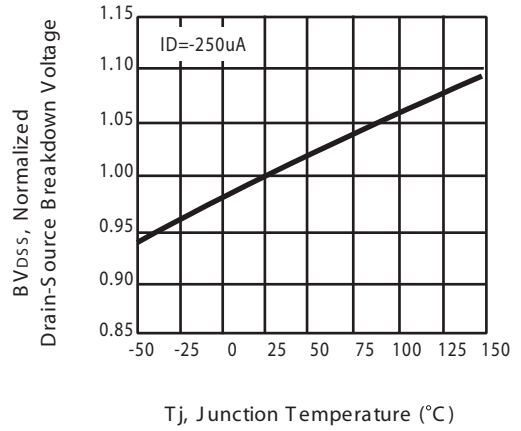

Figure 6. Breakdown Voltage Variation with Temperature

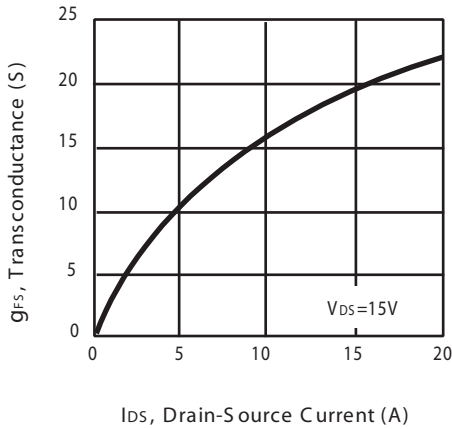

Figure 7. Transconductance Variation with Drain Current

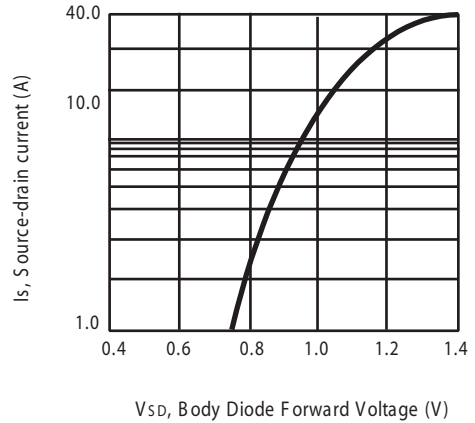

Figure 8. Body Diode Forward Voltage Variation with Source Current

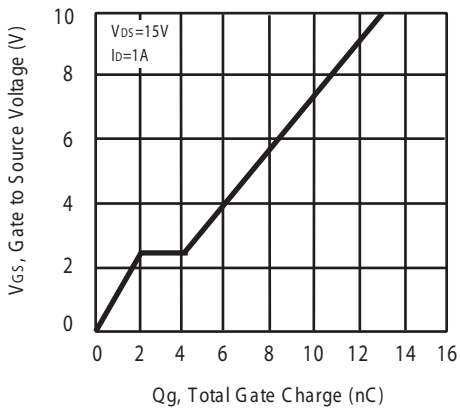

Figure 9. Gate Charge

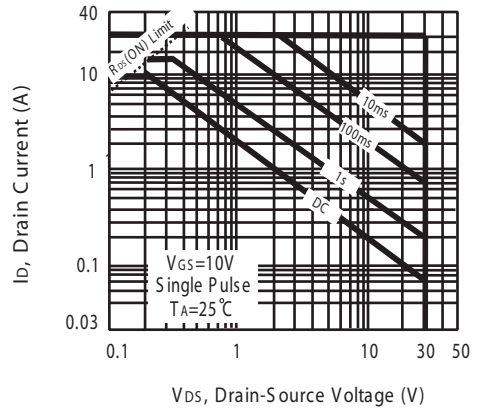

Figure 10. Maximum Safe Operating Area

# SDM9410

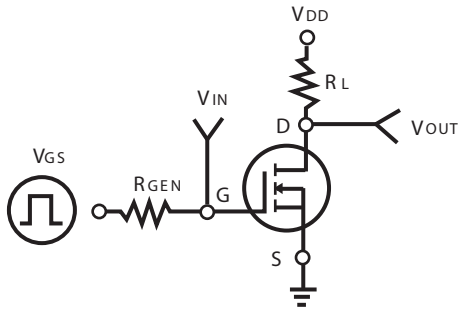

Figure 11. Switching Test Circuit

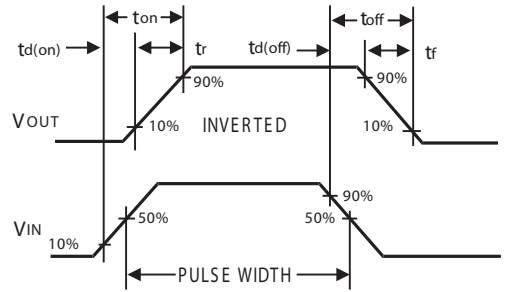

Figure 12. Switching Waveforms

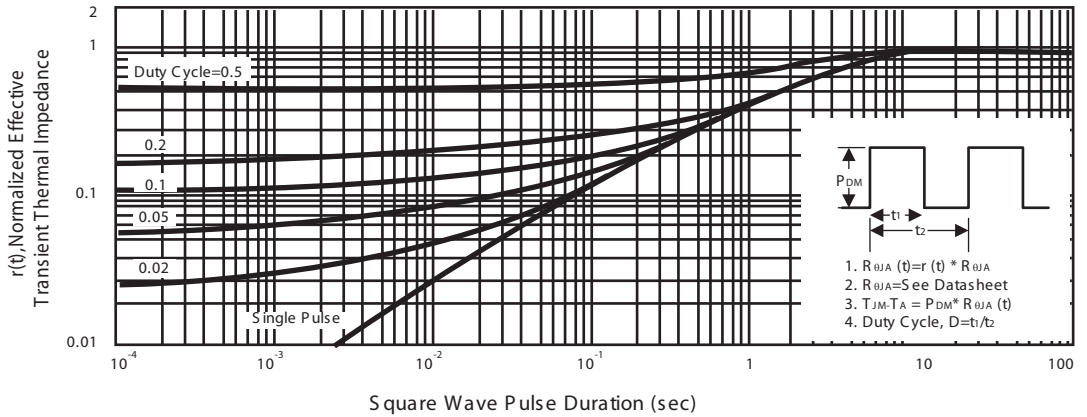

Figure 13. Normalized Thermal Transient Impedance Curve