

HD66781

720-channel Source Driver
for a-Si TFT/Low Temperature Poly-Si TFT Panels
with 262,144-color display RAM

REJxxxxxxx-xxxxZ
Rev.0.5
July.31.2003

• **Index**

Description	6
Features	7
Block Diagram	8
Pin Functions	9
HD66781 power-supply specification.....	14
Pad Arrangement.....	15
Pad Coordinate.....	16
Bump Arrangement.....	18
Example of Connecting HD66781 and HD66783	19
Example of Connecting HD66781 and HD667P21	20
Block Function.....	21
(1) System interface.....	21
(2) External Display Interface (RGB I/F, VSYNC I/F).....	22
(3) Address Counter (AC)	22
(4) Graphic RAM (GRAM).....	22
(5) Grayscale Voltage Generation Circuit	22
(6) Timing generator.....	23
(7) Oscillation Circuit (OSC)	23
(8) Liquid Crystal Display Driver Circuit	23
(9) Gate driver/power supply IC interfacing circuit	23
GRAM Address MAP	24
Relation between GRAM addresses and Screen positions (SS=0, BGR=0)	24
Relation between GRAM data and Display data (SS=0, BGR=0).....	25
Relation between GRAM address and Screen position (SS=1, BGR=1)	28
Relation between GRAM data and Display data (SS=1, BGR=1).....	29

Instruction	32
Outline	32
Instruction data format	33
Basic Operation modes	34
Index/Status/Display control instruction	35
Index (IR).....	35
Status read (SR)	35
Start Oscillation (R000h)	35
Driver Output Control (R001h).....	36
LCD Driving Wave Control (R002h)	36
Entry Mode 1 (R003h).....	37
Resizing Control 1/2 (R004/R005h)	42
Display Control 1 (R007h).....	44
Display Control 2 (R008h).....	46
Display Control 3 (R009h).....	47
Display Control 4 (R00Bh).....	49
External Display interface Control 1 (R00Ch).....	51
Frame Cycle Control (R00Dh).....	54
External Display Interface Control 2 (R00Eh).....	55
External Display Interface Control 3 (R00Fh).....	55
Gate Driver/LTPS LCD Panel Interface Control 1 (R010h).....	56
Gate Driver/LTPS LCD Panel Interface Control 2 (R011h).....	57
Gate Driver/LTPS LCD Panel Interface Control 3 (R012h).....	58
Gate Driver/LTPS LCD Panel Interface Control 4 (R013h).....	59
Gate Driver/LTPS LCD Panel Interface Control 5 (R015h).....	60
Gate Driver/LTPS LCD Panel Interface Control 6 (R016h).....	61
Gate Driver/LTPS LCD Panel Interface Control 7 (R017h).....	62
Gate Driver/LTPS LCD Panel Interface Control 8 (R018h).....	63
Gate Driver/LTPS LCD Panel Interface Control 9 (R019h).....	64
Gate Driver/LTPS LCD Panel Interface Control 10 (R01Bh)	65
Power control 1 (R100h).....	68
Gate Driver/ Power Supply IC Interface Control 1 (R110h).....	70
Gate Driver/ Power Supply IC Interface Control 2 (R111h).....	70
Setting examples	72
Common registers for HD66783 and HD667P21	73
Registers of HD66783.....	73
Registers of HD667P21	74
RAM Address set in horizontal/vertical directions (R200h/R201h)	76
RAM Access through RGB-I/F and System I/F.....	86
RAM Write Data Mask 1/2 (R203h/R204h)	89
Window Address Control Instructions.....	90
γ Control (R300h ~ R309h).....	91
Base image display control instructions.....	92
Instruction list	96
Reset Function	98

RAM Address and Display Position on the Panel	99
Notes to the setting of panel control registers	100
Screen settings	100
Base image display	100
OSD and α blending functions	102
OSD image data format.....	103
OSD image display setting.....	103
Resizing function	105
Contraction.....	105
Resizing setting.....	106
Instructions for Resizing	107
Notes to the resizing function	108
Magnification.....	109
Interface specification	112
System Interface.....	114
80-system 18-bit interface.....	115
80-system 16-bit interface.....	116
Data transmission synchronization in 16-bit bus interface mode.....	118
80-system 9-bit interface.....	119
Data transmission synchronization in 9-bit bus interface mode.....	120
80-system 8-bit interface (Big endian).....	121
Data transmission synchronization in 8-bit bus interface mode.....	124
Serial Peripheral interface (SPI)	125
80-system 8-bit interface (Little endian).....	128
Data transmission synchronization in 8-bit bus interface mode.....	130
DMA transfer Single Address mode	131
VSYNC Interface	134
Notes to the VSYNC interface.....	137
External Display Interface	139
Polarities of VSYNC, HSYNC, ENABLE, DOTCLK signals	140
RGB interface timing	140
Moving picture display in RGB Interface.....	142
RAM access through the system interface in RGB-I/F mode	142
6-bit RGB interface.....	143
Transfer synchronization function for a 6-bit bus interface	144
16-bit RGB interface.....	145
18-bit RGB interface.....	146
Notes to the external display interface.....	147
Display Synchronizing Data Transfer.....	148
Notes to the display synchronizing GRAM data transfer mode.....	150

Timing interfacing with LCD panel signals.....	151
High-Speed Burst RAM Write Function	153
Notes to the high-speed RAM write mode.....	154
High-Speed RAM Write with Window Address Function.....	155
Window Address Function	156
γ -Correction Function	157
Grayscale Amplifier Configuration.....	158
γ -Correction Registers.....	160
Ladder resistors and 8 to 1 selector.....	162
Variable resistors	162
Relationship between RAM data and output level (REV =0)	167
Relationship between RAM data and output level (REV =1)	168
Low Power Consumption Display Mode.....	169
8-color Display Mode	172
Oscillation Circuit.....	173
n-raster-row Inversion alternating Drive	174
Interlaced Drive	175
Alternating Timing.....	177
Frame-Frequency Adjustment Function	178
Relationship between Liquid Crystal Drive Duty and Frame Frequency	178
Partial Display Function	179
Power-saving drive settings	180
Equalization function.....	183
Specifications of external element of HD66781	184
Instruction Setting.....	185
Power-supply/display ON (LPTS = 0: a-Si TFT panel, with HD66783)	186
Power-supply/display OFF (LPTS = 0: a-Si TFT panel, with HD66783)	187
Power-supply/display ON (LPTS = 1: LTPS TFT panel, with HD667P21)	188
Power-supply/display OFF (LPTS = 1: LTPS TFT panel, with HD667P21)	189
Standby/Sleep mode.....	190
Deep standby mode.....	191
Low power consumption display mode.....	192
8-color mode.....	192

Partial display mode.....	193
Absolute Maximum Values	194

Description

The HD66781 is a 720-channel source driver with graphics acceleration function, incorporating RAM compliant to 262,144 TFT colors and 240RGB x 320 dot graphics. In combination with the HD66783, which incorporates a power-supply integrated circuit and a gate driver on a single chip, the HD66781 can drive an a-Si TFT panel of 240 RGB x 320 dots at maximum. Also in combination with the HD667P21, which is a power-supply IC chip, the HD66781 can drive a low-temperature poly-Si TFT panel of 240 RGB x 320 dots at maximum with an incorporated gate driver.

The HD66781's high-speed RAM-write function through a high-speed interface of 8/9/16/18-bit bus enables efficient data transfer with high-speed burst RAM write function. The HD66781 is compliant to DMA transfer single address mode to keep control on bus traffic occupation when a large volume of data is transferred from external memory. The HD66781 can also handle moving picture display through an RGB interface (VSYNC, HSYNC, DOTCLK, ENABLE, and PD 17 to 0).

The HD66781 incorporates RAM with the capacity of one QVGA-sized whole screen of 240 RGB x 320 x 18bits plus 96 raster-rows. In addition to OSD and α blending functions, which use this RAM area, the HD66781 also handles resizing function, which is compliant to data transfer for a large screen display. These functions make the HD66781 the best solution for the efficient and various ways of display.

The combined use of HD66781 with HD66783 or HD667P21 supports the function to reduce power consumption by a liquid crystal display system. The HD66781's RAM can display 240 RGB x 320-dot color display (max.) with low voltage operation up to 1.7 V. The HD66781 incorporates a voltage follower circuit to generate liquid crystal driving voltages and an interfacing circuit that enables through HD66781 to make instruction settings to HD66783 and HD667P21. In addition, the HD66781 supports power-saving modes such as standby mode and 8-color display mode, which allow precise power management by software. These features make this LSI the ideal solution for medium or small-sized portable battery-driven products such as digital cellular phones or small PDA with color displays, where long battery life and board size are a major concern.

Features

- Drive 262,144 TFT-color 240RGB x 320 dot graphics display in combination with HD66783 (a-Si TFT panel) or HD667P21 (low-temperature poly-Si TFT panel)
- Output signals to control HD66783, which incorporates a power supply integrated circuit and a gate driver on a single chip.
- Output signals to control a low-temperature poly-Si TFT panel with an incorporated gate driver (combined use with HD667P21)
- System interface
 - High-speed bus interface with 8-/9-/16-/18-bit data bus
 - Serial Peripheral Interface (SPI)
- Interfaces for moving picture display
 - RGB interface with 6-/16-/18-bit data bus (VSYNC, HSYNC, DOTCLK, ENABLE, PD17-0)
 - VSYNC interface (System interface + VSYNC)
- High-speed burst RAM write function
- Compliant to single address mode for DMA transfer that controls data bus occupation ratio when transferring data from external SRAM
- Window address function to write data to a rectangular area of RAM specified by the window address
 - Interfaces for moving picture display, which write data to a rectangular RAM address area
 - Reduce data transfer by transferring only the data for the moving picture display area
 - Simultaneous display of moving picture area and still picture area that displays the contents of internal RAM
 - Resizing function (contraction rate: x1/2, x1/4 / magnification rate: x2, x4)
- Various functions to control color display
 - Simultaneous availability of 262,144 colors (settings are programmable)
 - Partial OSD function
 - α -blending function (transmission rate: 0%, 25%, 50%, 75%, 100%)
- Features for low-power architecture
 - Interface I/O power supply IOVcc = 1.7 ~ 3.3 V
Vcc1 = 1.7 ~ 3.3 V
 - Logic regulator power supply Vcc = 2.5 ~ 3.3 V
 - Source driver liquid crystal driving voltage DDVDH-GND = 4.0 ~ 5.9 V
 - Power saving functions: standby mode, deep standby mode etc.
 - Step-up circuits to generate liquid crystal drive voltage up to 12 times (HD66783 and HD667P21)
 - Voltage followers for a liquid crystal drive power-supply, which fends off the direct current from bleeder-resistors
- Cst structure only (Common Vcom formula)
- 224,640-byte (240 x (320+96) x 18bits) internal RAM
- Incorporated LCD driver with 720 source outputs
- Compliant to COG

Block Diagram

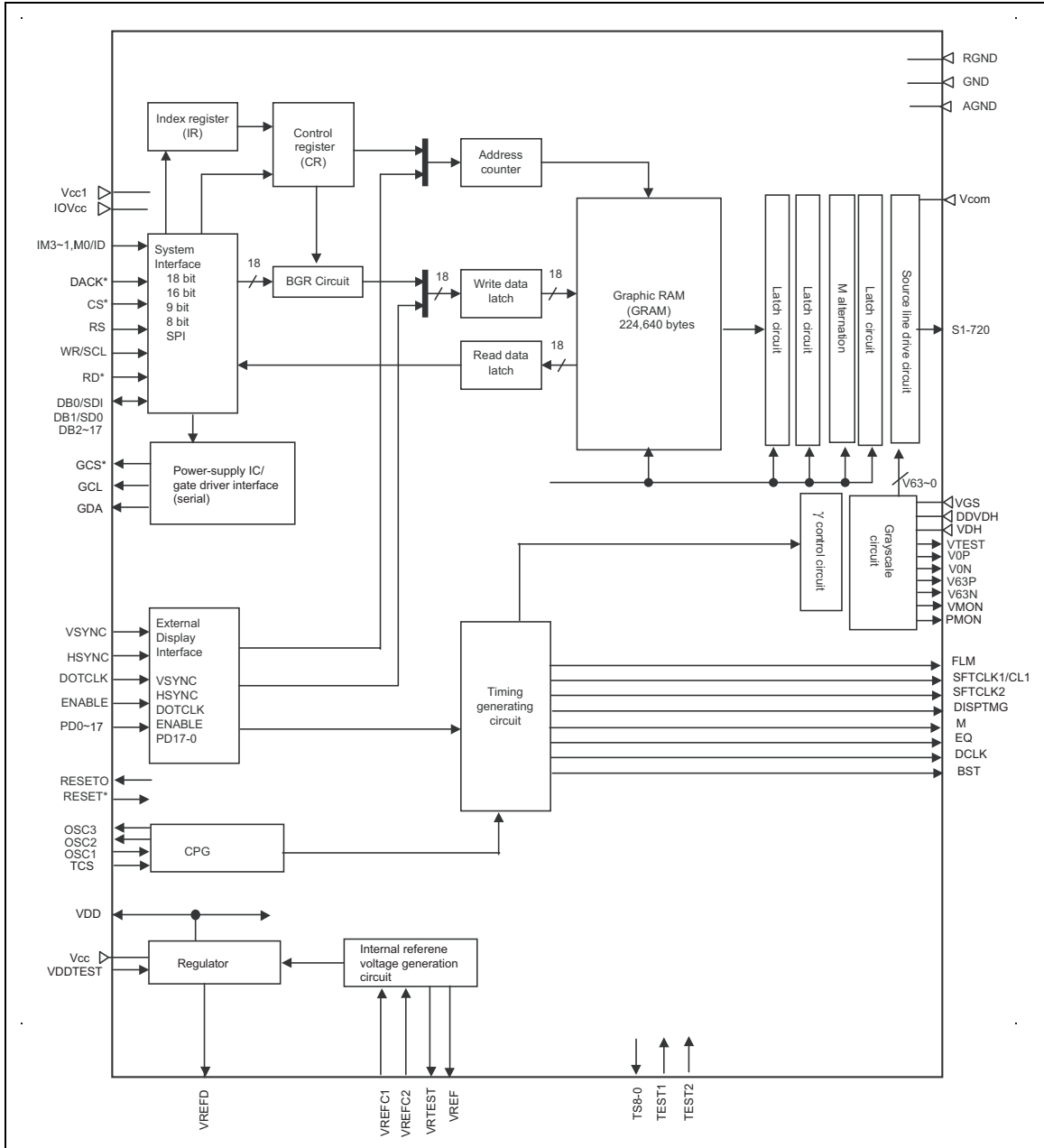

Pin Functions

Signals	Number of Pins	I/O	Connected to	Functions	Unused pins																																																																																											
IM3~1, IM0/ID	4	I	GND or Vcc1	<p>Pins to select an interfacing mode with MPU.</p> <table border="1"> <thead> <tr> <th>IM3</th> <th>IM2</th> <th>IM1</th> <th>IM0</th> <th>MPU-Interface Mode</th> <th>DB Pins</th> <th>Colors</th> </tr> </thead> <tbody> <tr> <td>0</td> <td>0</td> <td>0</td> <td>0</td> <td>Setting disabled</td> <td>-</td> <td>-</td> </tr> <tr> <td>0</td> <td>0</td> <td>0</td> <td>1</td> <td>Setting disabled</td> <td>-</td> <td>-</td> </tr> <tr> <td>0</td> <td>0</td> <td>1</td> <td>0</td> <td>80-system 16-bit interface</td> <td>DB17-10, DB8-1</td> <td>65,536 (Note 1)</td> </tr> <tr> <td>0</td> <td>0</td> <td>1</td> <td>1</td> <td>80-system 8-bit interface (Big-endian)</td> <td>DB17-10</td> <td>65,536 (Note 2)</td> </tr> <tr> <td>0</td> <td>1</td> <td>0</td> <td>*</td> <td>Serial peripheral interface (SPI)</td> <td>DB1-0</td> <td>65,536</td> </tr> <tr> <td>0</td> <td>1</td> <td>1</td> <td>0</td> <td>Setting disabled</td> <td>-</td> <td>-</td> </tr> <tr> <td>0</td> <td>1</td> <td>1</td> <td>1</td> <td>80-system 8-bit interface (Little-endian)</td> <td>DB17-10</td> <td>65,536 (Note 2)</td> </tr> <tr> <td>1</td> <td>0</td> <td>0</td> <td>0</td> <td>Setting disabled</td> <td>-</td> <td>-</td> </tr> <tr> <td>1</td> <td>0</td> <td>0</td> <td>1</td> <td>Setting disabled</td> <td>-</td> <td>-</td> </tr> <tr> <td>1</td> <td>0</td> <td>1</td> <td>0</td> <td>80-system 18-bit interface</td> <td>DB17-10</td> <td>262,144</td> </tr> <tr> <td>1</td> <td>0</td> <td>1</td> <td>1</td> <td>80-system 9-bit interface</td> <td>DB17-9</td> <td>262,144</td> </tr> <tr> <td>1</td> <td>1</td> <td>*</td> <td>*</td> <td>Setting disabled</td> <td>-</td> <td>-</td> </tr> </tbody> </table> <p>Note 1) 262,144 colors available (max.) in 2-transfer mode. Note 2) 262,144 colors available (max.) in 3-transfer mode.</p>	IM3	IM2	IM1	IM0	MPU-Interface Mode	DB Pins	Colors	0	0	0	0	Setting disabled	-	-	0	0	0	1	Setting disabled	-	-	0	0	1	0	80-system 16-bit interface	DB17-10, DB8-1	65,536 (Note 1)	0	0	1	1	80-system 8-bit interface (Big-endian)	DB17-10	65,536 (Note 2)	0	1	0	*	Serial peripheral interface (SPI)	DB1-0	65,536	0	1	1	0	Setting disabled	-	-	0	1	1	1	80-system 8-bit interface (Little-endian)	DB17-10	65,536 (Note 2)	1	0	0	0	Setting disabled	-	-	1	0	0	1	Setting disabled	-	-	1	0	1	0	80-system 18-bit interface	DB17-10	262,144	1	0	1	1	80-system 9-bit interface	DB17-9	262,144	1	1	*	*	Setting disabled	-	-	-
IM3	IM2	IM1	IM0	MPU-Interface Mode	DB Pins	Colors																																																																																										
0	0	0	0	Setting disabled	-	-																																																																																										
0	0	0	1	Setting disabled	-	-																																																																																										
0	0	1	0	80-system 16-bit interface	DB17-10, DB8-1	65,536 (Note 1)																																																																																										
0	0	1	1	80-system 8-bit interface (Big-endian)	DB17-10	65,536 (Note 2)																																																																																										
0	1	0	*	Serial peripheral interface (SPI)	DB1-0	65,536																																																																																										
0	1	1	0	Setting disabled	-	-																																																																																										
0	1	1	1	80-system 8-bit interface (Little-endian)	DB17-10	65,536 (Note 2)																																																																																										
1	0	0	0	Setting disabled	-	-																																																																																										
1	0	0	1	Setting disabled	-	-																																																																																										
1	0	1	0	80-system 18-bit interface	DB17-10	262,144																																																																																										
1	0	1	1	80-system 9-bit interface	DB17-9	262,144																																																																																										
1	1	*	*	Setting disabled	-	-																																																																																										
CS*	1	I	MPU	<p>Select the HD66781. Low: the HD66781 is selected and is accessible High: the HD66781 is not selected and is inaccessible</p>	IOVcc																																																																																											
RS	1	I	MPU	<p>Select the register. Low: Index/status registers High: Control registers</p>	IOVcc																																																																																											
WR*/SCL	1	I	MPU	<p>Write strobe signal in the 80-system bus interface Write data at the "Low" level. In the Serial Peripheral Interface, a synchronizing clock signal.</p>	-																																																																																											
RD*	1	I	MPU	<p>Read-strobe signal in the 80-system bus interface Read data at the "Low" level.</p>	IOVcc																																																																																											
DACK*	1	I	MPU	<p>Select the HD66781 in the DMA transfer single address mode. Low: Select the HD66781 (Accessible) High: Not Select the HD66781 (Inaccessible)</p>	Vcc1																																																																																											
DB0/SDI	1	I/O	MPU	<p>18-bit parallel bi-directional data bus. 8-bit bus: DB17-DB10 9-bit bus: DB17-DB9 16-bit bus: DB17-DB10 and DB8-DB1 18-bit bus: DB17-DB0 Serial data input pin (SDI) in the Serial Peripheral Interface mode to input data on the rising edge of SCL signal.</p>	IOVcc																																																																																											

Signals	Number of Pins	I/O	Connected to	Functions	Unused pins
DB1~/SDO	1	I/O	MPU	18-bit parallel bi-directional data bus. 8-bit bus: DB17-DB10 9-bit bus: DB17-DB9 16-bit bus: DB17-DB10 and DB8-DB1 18-bit bus: DB17-DB0 Serial data output pin (SDO) in the Serial Peripheral Interface mode to output data on the falling edge of SCL signal.	IOVcc
DB2~DB17	16	I/O	MPU	18-bit parallel bi-directional data bus. 8-bit bus: DB17-DB10 9-bit bus: DB17-DB9 16-bit bus: DB17-DB10 and DB8-DB1 18-bit bus: DB17-DB0	IOVcc
RESET*	1	I	MPU or external R-C circuit	Reset pin. Initialize the LSI at the "Low" level. A power-on reset required after turning on the power.	-
RESETO1 RESETO2	2	O	HD66783 or HD667P21	Output the same polarity level as RESET*. Control both HD66781 and HD66783 or HD66781 and HD667P21 by connecting to HD66783 or HD667P21.	Open
OSC1 OSC2	2	I or O	Oscillation resistor	Connect an external resistor for R-C oscillation.	-
ENABLE	1	I	MPU or LCDC	Data enable signal in the RGB interface mode. Low: Select (accessible) High: Not select (inaccessible) ENABLE signal inverts the polarity according to the setting of EPL resistor. Set ENABLE inactive while it is not used and its level is fixed or the polarity is set with registers.	GND/ IOVcc
VSYNC	1	I	MPU or LCDC	Frame synchronizing signal. This signal is active low. The polarity of VSYNC is inverted by setting VSPL register. Set VSYNC inactive while it is not used and its level is fixed or the polarity is set with registers.	GND/ IOVcc
HSYNC	1	I	MPU or LCDC	Line synchronizing signal. This signal is active low. The polarity of HSYNC is inverted by setting HSPL register. Set HSYNC inactive while it is not used and its level is fixed or the polarity is set with registers.	GND/ IOVcc
DOTCLK	1	I	MPU or LCDC	Dot clock signal. The timing of data input is determined at the rising edge. This signal is active low. The polarity of DOTCLK is inverted by setting DPL register. Set DOTCLK inactive while it is not used and its level is fixed or the polarity is set with registers.	GND/ IOVcc
PD0~PD17	18	I	MPU or LCDC	18-bit bus for RGB data. 6-bit bus: PD17-PD12 16-bit bus: PD17-PD13 and PD11-PD1 18-bit bus: PD17-PD0	GND/ IOVcc

Signals	Number of Pins	I/O	Connected to	Functions	Unused pins
BST	1	O	MPU or LCDC	Output a pulse that indicates the start of blank (front porch). When writing data in synchronization with display scan, serve as a trigger signal. Amplitude: Vcc1 and GND.	Open
S1~S720	720	O	Liquid Crystal	Output a voltage applied to liquid crystal. The correspondence between the RAM write address and source output signal is changeable with SS bit. When SS=0, data in the RAM address "h00000" are output from S1-3. When SS=1, data in the RAM address "h00000" are output from S718-720. S1, S4, S7, ... display red (R), S2, S5, S8, ... display green (G), and S3, S6, S9, ... display blue (B) (SS = 0).	Open
FLM1 FLM2	2	O	HD66783 or HD667P21	Output a frame head pulse.	Open
CL11/ SFTCLK11 CL12/ SFTCLK12	2	O	HD66783 or HD667P21	Output a different signal according to the LTPS register setting. LTPS=0: Output a pulse of one line cycle. Connect to CL1 pin of HD66783. LTPS=1: Gate shift clock for LTPS. Output a pulse of 2-line cycles.	Open
SFTCLK21 SFTCLK22	2	O	HD667P21	Output a different signal according to the LTPS register setting. LTPS=0: Output is GND. No connection with HD66783 is required. LTPS=1: Gate shift clock for LTPS. Output a pulse of 2-line cycles.	Open
DISPTMG1 DISPTMG2	2	O	HD66783 or HD667P21	Gate off signal during partial display. Low: Voff output High: Normal output For an LTPS LCD panel, a control signal for the gate driver incorporated therein.	Open
M1 M2	2	O	HD66783 or HD667P21	Output alternating pulse.	Open
EQ1 EQ2	2	O	HD66783 or HD667P21	Make Vcom output Hi-z in Vcom transition timing during Vcom alternating drive. Low: Output VcomH or VcomL from Vcom High: Make Vcom output Hi-z	Open
DCCLK1 DCCLK2	2	O	HD66783 or HD667P21	Output step-up clocks.	Open
GCL1 GCL2	2	O	HD66783 or HD667P21	Clock signal for making a serial transfer of values set in registers to gate driver/power supply IC. Output data from the falling edge of the clock.	Open
GDA1 GDA2	2	O	HD66783 or HD667P21	Data signal for making a serial transfer of values set in registers to gate driver/power supply IC.	Open
GCS1* GCS2*	2	O	HD66783 or HD667P21	Select the HD66781. Low: Select the HD66781 (Serial transfer) High: Not select the HD66781 (Serial transfer not available)	Open

Signals	Number of Pins	I/O	Connected to	Functions	Unused pins
GND	1	-	Power supply	Ground for the logic side. GND = 0V When assembled on COG, connect to GND on the FPC to avoid effects from the noise.	-
AGND	1	-	Power supply	Ground for the I/O side and analogue circuits other than logic circuits and the internal GRAM, which operate with VDD voltage. AGND = 0V When assembled on COG, connect to GND on the FPC to avoid effects from the noise.	-
RGND	1	-	Power supply	Ground for the internal RAM. RGND = 0V. When assembled on COG, connect to GND on the FPC to avoid effects from the noise.	-
IOVcc	1	-	Power supply	Supply with the power supply voltage for interface pins. IOVcc = 1.7~3.3V. IOVcc ≤ Vcc1 ≤ Vcc	-
Vcc	1	I	Power supply	Power supply for internal logic regulator. Connect to an external power supply of Vcc = 2.5~3.3V. IOVcc ≤ Vcc1 ≤ Vcc	-
Vcc1	1	I	Power supply	Power supply voltage for a deep standby control circuit and the I/O side. IOVcc ≤ Vcc1 ≤ Vcc	-
VREF	1	O	Power supply	Reference voltage output for internal logic regulator. Leave open.	Open
VDD	1	I/O	Stabilizing Capacitor	Power supply output for an internal logic. Do not connect to other than stabilizing capacitors.	-
DDVDH	1	I	HD66783 or HD667P21	Supply with a liquid crystal drive voltage through HD66783 or HD667P21. DDVDH = +4.0V~+5.9V	-
VDH	1	I	HD66783 or HD667P21	A reference level for a grayscale voltage generation circuit. Can be supplied through HD66783 or HD667P21.	-
VGS	1	I	GND or External Resistor	A reference level for a grayscale voltage generation circuit. Connect to an external variable resistor to make a level adjustment for each panel.	-
Vcom	1	I	HD66783 or HD667P21	Signal for equalization. Short-circuit all liquid crystal output (S1~S720) to Vcom level (Hi-z) while EQ = High. Leave open when Vcom < 0V.	Open
TEST1 TEST2	2	I	GND	Test pins. Must be fixed to the GND level.	-
TSC	1	I	GND	Test pin. Must be fixed to the GND level.	-
OSC3	1	O	Open	Test pin. Leave open.	Open
TS8-0	9	O	Open	Test pins. Leave open.	Open
VTEST	1	O	Open	Test pin. Leave open.	Open
VRTEST	1	O	Open	Test pin. Leave open.	Open
VREFC1 VREFC2	2	I	GND	Test pins. Must be fixed to GND level.	-

Signals	Number of Pins	I/O	Connected to	Functions	Unused pins
VDDTEST	1	I	GND	Test pin. Must be fixed to GND level.	-
VREFD	1	O	Open	Test pin. Leave open.	Open
PMON	1	O	Open	Test pin. Leave open.	Open
VMON	1	O	Open	Test pin. Leave open.	Open
VOP V63P	2	I or O	Open	Test pins. Leave open.	-
VON V63N	2	I or O	Open	Test pins. Leave open.	-
TIN1	1	I	GND	Test pin. Must be fixed to GND level.	-
TOUT1-3	3	O	Open	Test pins. Leave open.	Open
TVcc1 TVcc2	2	I	GND	Test pins. Must be fixed to GND level.	-
DUMMY14 DUMMY15	2	-	-	Dummy pads. DUMMY 14 and DUMMY 15 are short-circuited within the LSI. Available for measuring COG contact resistor.	Open
DUMMY 1~13, 16~30	28	-	Open	Dummy pads. Must be left open.	Open
IOVccDUM 1~3	3	O	Input pins	Output an internal IOVcc level. When neighboring input pins are fixed to IOVcc, short-circuit them.	Open
Vcc1DUM1 Vcc1DUM2	2	O	Input pins	Output an internal Vcc1 level. When neighboring input pins are fixed to Vcc1, short-circuit them.	Open
AGNDDUM 1-4	4	O	Input pins	Output an internal AGND level. When neighboring input pins are fixed to AGND, short-circuit them.	Open
TESTO1 TESTO2	2	O	Open	Test pins. Leave open.	-

HD66781 power-supply specification

Item			Voltage range	Specification
Input Voltage	IOVcc	Interface voltage 1	+1.7V~+3.3V	Power supply for signals interfacing with MPU or LCDC. Supply through the system. Power supply for CS*, RS, WR*/SCL, RD*, DB17-2, DB1/SDO, DB0/SDI, VSYNC, HSYNC, ENABLE, PD17-0. Connect on the FPC when using at the same electric potential with Vcc1.
	Vcc1	Interface voltage 2	+1.7V~+3.3V	Power supply for signals interfacing with a gate driver/power supply IC and a deep standby mode control circuit that halts the logic regulator. Supply with the same electric potential with Vcc of HD66783 or HD667P21 though the system. Power supply for FLM1, FLM2, CL11/SFTCLK11, CL12/SFTCLK12, SFTCLK21, SFTCLK22, M1, M2, EQ1, EQ2, DCCLK1, DCCLK2, GCL1, GCL2, GDA1, GDA2, GCS1*, GCS2*, RESET*, RESETO1, RESETO2, DACK*, BST, M3-1, IM0/ID. Connect on the FPC when using at the same potential with IOVcc.
	Vcc	Power supply for the logic regulator	+2.5V~+3.3V	Supply through the system. Connect on the FPC when using at the same electric potential with Vci of HD66783 or HD667P21.
	VDD	Power supply for the Internal logic	-	Generated from the internal logic regulator. Supply through the system is not required.
	GND	-	0V	GND for the internal logic circuit. Connect to GND on the FPC.
	RGND	-	0V	GND for the internal GRAM. Connect to GND on the FPC.
	AGND	-	0V	GND for the I/O side and analogue circuits other than logic circuits and the internal GRAM, which operate with VDD voltage. Connect to GND on the FPC.
LCD drive voltage	DDVDH	-	+4.5V~+5.9V	Connect to DDVDH of HD66783 or HD667P21.
Source driver grayscale reference voltage	VDH	-	+3.0V~(DDVDH-0.5)V	Connect to VREG1OUT of HD66783 or HD667P21.
	VGS	-	-	Connect to GND or variable resistor.
LCD drive output	S1~S720	V0~V63 grayscale level	-	-

Pad Coordinate

Unit: μm			
pad name	X	Y	
10UMMY1	-780.0	-1356.3	
2TEST01	-780.0	-1356.3	
3FLM1	-780.0	-1356.3	
4SFCLK21	-772.0	-1356.3	
5CL11/SFCLK11	-764.0	-1356.3	
6IM1	-756.0	-1356.3	
7EG1	-748.0	-1356.3	
8DISPTMG1	-740.0	-1356.3	
9IGDA1	-732.0	-1356.3	
10GCS1*	-724.0	-1356.3	
11GCL1	-716.0	-1356.3	
12DCCLK1	-708.0	-1356.3	
13RESETO1	-700.0	-1356.3	
14DUMMY2	-692.0	-1356.3	
15RESE2*	-684.0	-1356.3	
16BST	-676.0	-1356.3	
17DUMMY3	-668.0	-1356.3	
18DB17	-660.0	-1356.3	
19DB16	-652.0	-1356.3	
20DB15	-644.0	-1356.3	
21DB14	-636.0	-1356.3	
22DB13	-628.0	-1356.3	
23DB12	-620.0	-1356.3	
24DB11	-612.0	-1356.3	
25DB10	-604.0	-1356.3	
26DB9	-596.0	-1356.3	
27IOVccDUM1	-588.0	-1356.3	
28DB8	-580.0	-1356.3	
29DB7	-572.0	-1356.3	
30DB6	-564.0	-1356.3	
31DB5	-556.0	-1356.3	
32DB4	-548.0	-1356.3	
33DB3	-540.0	-1356.3	
34DB2	-532.0	-1356.3	
35DB1/SDO	-524.0	-1356.3	
36DISPTMG2	-516.0	-1356.3	
37IOVccDUM2	-508.0	-1356.3	
38RD*	-500.0	-1356.3	
39WR1/SCL	-492.0	-1356.3	
40RS	-484.0	-1356.3	
41CS	-476.0	-1356.3	
42DUMMY4	-468.0	-1356.3	
43DACK*	-460.0	-1356.3	
44Vcc1DUM1	-452.0	-1356.3	
45V3VNC	-444.0	-1356.3	
46HSYNC	-436.0	-1356.3	
47DOTCLK	-428.0	-1356.3	
48ENABLE	-420.0	-1356.3	
49PD17	-412.0	-1356.3	
50PD16	-404.0	-1356.3	
51PD15	-396.0	-1356.3	
52PD14	-388.0	-1356.3	
53PD13	-380.0	-1356.3	
54PD12	-372.0	-1356.3	
55PD11	-364.0	-1356.3	
56PD10	-356.0	-1356.3	
57PD9	-348.0	-1356.3	
58PD8	-340.0	-1356.3	
59PD7	-332.0	-1356.3	
60PD6	-324.0	-1356.3	
61PD5	-316.0	-1356.3	
62PD4	-308.0	-1356.3	
63PD3	-300.0	-1356.3	
64PD2	-292.0	-1356.3	
65PD1	-284.0	-1356.3	
66PD0	-276.0	-1356.3	
67IOVcc	-268.0	-1356.3	
68TOUT1	-260.0	-1356.3	
69IOVcc	-252.0	-1356.3	
70IOVcc	-244.0	-1356.3	
71Vcc1	-236.0	-1356.3	
72Vcc1	-228.0	-1356.3	
73Vcc1	-220.0	-1356.3	
74Vcc1	-212.0	-1356.3	
75Vcc	-204.0	-1356.3	
76Vcc	-196.0	-1356.3	
77Vcc	-188.0	-1356.3	
78Vcc	-180.0	-1356.3	
79Vcc	-172.0	-1356.3	
80Vcc	-164.0	-1356.3	
81Vcc	-156.0	-1356.3	
82Vcc	-148.0	-1356.3	
83Vcc	-140.0	-1356.3	
84VDD	-132.0	-1356.3	
85VDD	-124.0	-1356.3	
86VDD	-116.0	-1356.3	
87VDD	-108.0	-1356.3	
88VDD	-100.0	-1356.3	
89VDD	-92.0	-1356.3	
90VDD	-84.0	-1356.3	
91VDD	-76.0	-1356.3	
92VDD	-68.0	-1356.3	
93VDD	-60.0	-1356.3	
94VDD	-52.0	-1356.3	
95VDD	-44.0	-1356.3	
96VDD	-36.0	-1356.3	
97VDD	-28.0	-1356.3	
98VDD	-20.0	-1356.3	
99GND	-12.0	-1356.3	
100GND	-4.0	-1356.3	
101GND	4.0	-1356.3	
102GND	12.0	-1356.3	
103RND	20.0	-1356.3	
104RND	28.0	-1356.3	
105RND	36.0	-1356.3	
106RND	44.0	-1356.3	
107RND	52.0	-1356.3	
108RND	60.0	-1356.3	
109RND	68.0	-1356.3	
110RND	76.0	-1356.3	
111RND	84.0	-1356.3	
112RND	92.0	-1356.3	
113AGND	100.0	-1356.3	
114AGND	108.0	-1356.3	
115AGND	116.0	-1356.3	
116AGND	124.0	-1356.3	
117AGND	132.0	-1356.3	
118AGND	140.0	-1356.3	
119AGND	148.0	-1356.3	
120AGND	156.0	-1356.3	
121DDVDH	164.0	-1356.3	
122DDVDH	172.0	-1356.3	
123DDVDH	180.0	-1356.3	
124DDVDH	188.0	-1356.3	
125DDVDH	196.0	-1356.3	
126DDVDH	204.0	-1356.3	
127DDVDH	212.0	-1356.3	
128VDP	220.0	-1356.3	
129VON	228.0	-1356.3	
130VSP	236.0	-1356.3	
131VSN	244.0	-1356.3	
132VGS	252.0	-1356.3	
133VDH	260.0	-1356.3	
134PNON	268.0	-1356.3	
135VMON	276.0	-1356.3	
136VTEST	284.0	-1356.3	
137Vcom	292.0	-1356.3	
138Vcom	300.0	-1356.3	
139DUMMY5	308.0	-1356.3	
140VREFD	316.0	-1356.3	
141VREFST	324.0	-1356.3	
142VREF	332.0	-1356.3	
143DUMMY6	340.0	-1356.3	
144VREFC1	348.0	-1356.3	
145VREFC2	356.0	-1356.3	
146VREFD	364.0	-1356.3	
147DUMMY7	372.0	-1356.3	
148TSC	380.0	-1356.3	
149AGNDUM1	388.0	-1356.3	
150DUMMY8	396.0	-1356.3	
151OSC1	404.0	-1356.3	
152DUMMY9	412.0	-1356.3	
153DUMMY10	420.0	-1356.3	
154DUMMY11	428.0	-1356.3	
155DUMMY12	436.0	-1356.3	
156DUMMY13	444.0	-1356.3	
157OSC2	452.0	-1356.3	
158IOVccDUM3	460.0	-1356.3	
159DUMMY14	468.0	-1356.3	
160IM1	476.0	-1356.3	
161IM2	484.0	-1356.3	
162IM3	492.0	-1356.3	
163AGNDUM2	500.0	-1356.3	
164TEST1	508.0	-1356.3	
165TEST2	516.0	-1356.3	
166TEST3	524.0	-1356.3	
167TEST4	532.0	-1356.3	
168TSC	540.0	-1356.3	
169TSC	548.0	-1356.3	
170TSC	556.0	-1356.3	
171TSC	564.0	-1356.3	
172TSC	572.0	-1356.3	
173TSC1	580.0	-1356.3	
174TSC	588.0	-1356.3	
175DTEST	596.0	-1356.3	
176DCCLK2	604.0	-1356.3	
177GCL2	612.0	-1356.3	
178GCL1	620.0	-1356.3	
179GDA2	628.0	-1356.3	
180DISPTMG2	636.0	-1356.3	
181ECC	644.0	-1356.3	
182ECC	652.0	-1356.3	
183CL12/SFCLK12	660.0	-1356.3	
184SFCLK22	668.0	-1356.3	
185FLM2	676.0	-1356.3	
186AGNDUM3	684.0	-1356.3	
187TWT	692.0	-1356.3	
188TWT	700.0	-1356.3	
189TOUT2	708.0	-1356.3	
190TOUT3	716.0	-1356.3	
191AGNDUM4	724.0	-1356.3	
192Vtcc2	732.0	-1356.3	
193DUMMY12	740.0	-1356.3	
194DUMMY13	748.0	-1356.3	
195DUMMY14	756.0	-1356.3	
196DUMMY15	764.0	-1356.3	
197DUMMY16	772.0	-1356.3	
198DUMMY16	780.0	-1356.3	
199TEST02	788.0	-1356.3	
200DUMMY17	796.0	-1356.3	
201DUMMY18	804.0	-1356.3	
202DUMMY19	812.0	-1356.3	
203S720	820.0	-1078.4	
204S719	820.0	-1048.4	
205S718	839.6	-1020.4	
206S717	820.6	-992.4	
207S716	839.6	-964.4	
208S715	820.6	-936.4	
209S714	839.6	-908.4	
210S713	820.6	-880.4	
211S712	839.6	-852.4	
212S711	820.6	-824.4	
213S710	839.6	-796.4	
214S709	820.6	-768.4	
215S708	839.6	-740.4	
216S707	820.6	-712.4	
217S706	839.6	-684.4	
218S705	820.6	-656.4	
219S704	839.6	-628.4	
220S703	820.6	-600.4	
221S702	839.6	-572.4	
222S701	820.6	-544.4	
223S700	839.6	-516.4	
224S699	820.6	-488.4	
225S698	839.6	-460.4	
226S697	820.6	-432.4	
227S696	839.6	-404.4	
228S695	820.6	-376.4	
229S694	839.6	-348.4	
230S693	820.6	-320.4	
231S692	839.6	-292.4	
232S691	820.6	-264.4	
233S690	839.6	-236.4	
234S689	820.6	-208.4	
235S688	839.6	-180.4	
236S687	820.6	-152.4	
237S686	839.6	-124.4	
238S685	820.6	-96.4	
239S684	839.6	-68.4	
240S683	820.6	-40.4	
241S682	839.6	-12.4	
242S681	820.6	15.6	
243S680	839.6	43.6	
244S679	820.6	71.6	
245S678	839.6	99.6	
246S677	820.6	127.6	
247S676	839.6	155.6	
248S675	820.6	183.6	
249S674	839.6	211.6	
250S673	820.6	239.6	
251S672	839.6	267.6	
252S671	820.6	295.6	
253S670	839.6	323.6	
254S669	820.6	351.6	
255S668	839.6	379.6	
256S667	820.6	407.6	
257S666	839.6	435.6	
258S665	820.6	463.6	
259S664	839.6	491.6	
260S663	820.6	519.6	
261S662	839.6	547.6	
262S661	820.6	575.6	
263S660	839.6	603.6	
264S659	820.6	631.6	
265S658	839.6	659.6	
266S657	820.6	687.6	
267S656	839.6	715.6	
268S655	820.6	743.6	
269S654	839.6	771.6	
270S653	820.6	799.6	
271S652	839.6	827.6	
272S651	820.6	855.6	
273S650	839.6	883.6	
274S649	820.6	911.6	
275S648	839.6	939.6	
276S647	820.6	967.6	
277S646	839.6	995.6	
278S645	820.6	1023.6	
279S644	839.6	1051.6	
280DUMMY20	820.6	1079.6	
281DUMMY21	839.6	1107.6	
282DUMMY22	788.0	1364.6	
283DUMMY23	792.0	1229.6	
284DUMMY24	794.0	1364.6	
285S643	788.0	1229.6	
286S642	790.0	1364.6	
287S641	784.0	1229.6	
288S640	792.0	1364.6	
289S639	784.0	1229.6	
290S638	776.0	1364.6	
291S637	772.0	1229.6	
292S636	770.0	1364.6	
293S635	762.0	1229.6	
294S634	764.0	1364.6	
295S633	756.0	1229.6	
296S632	758.0	1364.6	
297S631	750.0	1229.6	
298S630	752.0	1364.6	
299S629	744.0	1229.6	
300S628	746.0	1364.6	
301S627	748.0	12	

part no	pad name	X	Y	part no	pad name	X	Y	part no	pad name	X	Y	part no	pad name	X	Y
481 S447	2408.0	1229.0		601 S327	-952.0	1229.0		721 S207	-4312.0	1229.0		841 S87	-7672.0	1229.0	
482 S446	2390.0	1364.0		602 S326	-860.0	1364.0		722 S206	-4340.0	1364.0		842 S86	-7700.0	1364.0	
483 S445	2352.0	1229.0		603 S325	-1008.0	1229.0		723 S205	-4368.0	1229.0		843 S85	-7732.0	1229.0	
484 S444	2324.0	1364.0		604 S324	-1036.0	1364.0		724 S204	-4396.0	1364.0		844 S84	-7766.0	1364.0	
485 S443	2296.0	1229.0		605 S323	-1064.0	1229.0		725 S203	-4424.0	1229.0		845 S83	-7784.0	1229.0	
486 S442	2268.0	1364.0		606 S322	-1092.0	1364.0		726 S202	-4452.0	1364.0		846 S82	-7812.0	1364.0	
487 S441	2240.0	1229.0		607 S321	-1120.0	1229.0		727 S201	-4480.0	1229.0		847 S81	-7840.0	1229.0	
488 S440	2212.0	1364.0		608 S320	-1148.0	1364.0		728 S200	-4508.0	1364.0		848 S80	-7868.0	1364.0	
489 S439	2184.0	1229.0		609 S319	-1176.0	1229.0		729 S199	-4536.0	1229.0		849 S79	-7896.0	1229.0	
490 S438	2156.0	1364.0		610 S318	-1204.0	1364.0		730 S198	-4564.0	1364.0		850 S78	-7924.0	1364.0	
491 S437	2128.0	1229.0		611 S317	-1232.0	1229.0		731 S197	-4592.0	1229.0		851 DUMMY28	-7952.0	1229.0	
492 S436	2100.0	1364.0		612 S316	-1260.0	1364.0		732 S196	-4620.0	1364.0		852 DUMMY28	-7980.0	1364.0	
493 S435	2072.0	1229.0		613 S315	-1288.0	1229.0		733 S195	-4648.0	1229.0		853 DUMMY27	-8339.6	1107.6	
494 S434	2044.0	1364.0		614 S314	-1316.0	1364.0		734 S194	-4676.0	1364.0		854 DUMMY28	-8204.6	1079.6	
495 S433	2016.0	1229.0		615 S313	-1344.0	1229.0		735 S193	-4704.0	1229.0		855 S77	-8339.6	1051.0	
496 S432	1988.0	1364.0		616 S312	-1372.0	1364.0		736 S192	-4732.0	1364.0		856 S76	-8204.6	1023.0	
497 S431	1960.0	1229.0		617 S311	-1400.0	1229.0		737 S191	-4760.0	1229.0		857 S75	-8339.6	995.0	
498 S430	1932.0	1364.0		618 S310	-1428.0	1364.0		738 S190	-4788.0	1364.0		858 S74	-8204.6	967.0	
499 S429	1904.0	1229.0		619 S309	-1456.0	1229.0		739 S189	-4816.0	1229.0		859 S73	-8339.6	939.0	
500 S428	1876.0	1364.0		620 S308	-1484.0	1364.0		740 S188	-4844.0	1364.0		860 S72	-8204.6	911.0	
501 S427	1848.0	1229.0		621 S307	-1512.0	1229.0		741 S187	-4872.0	1229.0		861 S71	-8339.6	883.0	
502 S426	1820.0	1364.0		622 S306	-1540.0	1364.0		742 S186	-4900.0	1364.0		862 S70	-8204.6	855.0	
503 S425	1792.0	1229.0		623 S305	-1568.0	1229.0		743 S185	-4928.0	1229.0		863 S69	-8339.6	827.0	
504 S424	1764.0	1364.0		624 S304	-1596.0	1364.0		744 S184	-4956.0	1364.0		864 S68	-8204.6	799.0	
505 S423	1736.0	1229.0		625 S303	-1624.0	1229.0		745 S183	-4984.0	1229.0		865 S67	-8339.6	771.0	
506 S422	1708.0	1364.0		626 S302	-1652.0	1364.0		746 S182	-5012.0	1364.0		866 S66	-8204.6	743.0	
507 S421	1680.0	1229.0		627 S301	-1680.0	1229.0		747 S181	-5040.0	1229.0		867 S65	-8339.6	715.0	
508 S420	1652.0	1364.0		628 S300	-1708.0	1364.0		748 S180	-5068.0	1364.0		868 S64	-8204.6	687.0	
509 S419	1624.0	1229.0		629 S299	-1736.0	1229.0		749 S179	-5096.0	1229.0		869 S63	-8339.6	659.0	
510 S418	1596.0	1364.0		630 S298	-1764.0	1364.0		750 S178	-5124.0	1364.0		870 S62	-8204.6	631.0	
511 S417	1568.0	1229.0		631 S297	-1792.0	1229.0		751 S177	-5152.0	1229.0		871 S61	-8339.6	603.0	
512 S416	1540.0	1364.0		632 S296	-1820.0	1364.0		752 S176	-5180.0	1364.0		872 S60	-8204.6	575.0	
513 S415	1512.0	1229.0		633 S295	-1848.0	1229.0		753 S175	-5208.0	1229.0		873 S59	-8339.6	547.0	
514 S414	1484.0	1364.0		634 S294	-1876.0	1364.0		754 S174	-5236.0	1364.0		874 S58	-8204.6	519.0	
515 S413	1456.0	1229.0		635 S293	-1904.0	1229.0		755 S173	-5264.0	1229.0		875 S57	-8339.6	491.0	
516 S412	1428.0	1364.0		636 S292	-1932.0	1364.0		756 S172	-5292.0	1364.0		876 S56	-8204.6	463.0	
517 S411	1400.0	1229.0		637 S291	-1960.0	1229.0		757 S171	-5320.0	1229.0		877 S55	-8339.6	435.0	
518 S410	1372.0	1364.0		638 S290	-1988.0	1364.0		758 S170	-5348.0	1364.0		878 S54	-8204.6	407.0	
519 S409	1344.0	1229.0		639 S289	-2016.0	1229.0		759 S169	-5376.0	1229.0		879 S53	-8339.6	379.0	
520 S408	1316.0	1364.0		640 S288	-2044.0	1364.0		760 S168	-5404.0	1364.0		880 S52	-8204.6	351.0	
521 S407	1288.0	1229.0		641 S287	-2072.0	1229.0		761 S167	-5432.0	1229.0		881 S51	-8339.6	323.0	
522 S406	1260.0	1364.0		642 S286	-2100.0	1364.0		762 S166	-5460.0	1364.0		882 S50	-8204.6	295.0	
523 S405	1232.0	1229.0		643 S285	-2128.0	1229.0		763 S165	-5488.0	1229.0		883 S49	-8339.6	267.0	
524 S404	1204.0	1364.0		644 S284	-2156.0	1364.0		764 S164	-5516.0	1364.0		884 S48	-8204.6	239.0	
525 S403	1176.0	1229.0		645 S283	-2184.0	1229.0		765 S163	-5544.0	1229.0		885 S47	-8339.6	211.0	
526 S402	1148.0	1364.0		646 S282	-2212.0	1364.0		766 S162	-5572.0	1364.0		886 S46	-8204.6	183.0	
527 S401	1120.0	1229.0		647 S281	-2240.0	1229.0		767 S161	-5600.0	1229.0		887 S45	-8339.6	155.0	
528 S400	1092.0	1364.0		648 S280	-2268.0	1364.0		768 S160	-5628.0	1364.0		888 S44	-8204.6	127.0	
529 S399	1064.0	1229.0		649 S279	-2296.0	1229.0		769 S159	-5656.0	1229.0		889 S43	-8339.6	99.0	
530 S398	1036.0	1364.0		650 S278	-2324.0	1364.0		770 S158	-5684.0	1364.0		890 S42	-8204.6	71.0	
531 S397	1008.0	1229.0		651 S277	-2352.0	1229.0		771 S157	-5712.0	1229.0		891 S41	-8339.6	43.0	
532 S396	980.0	1364.0		652 S276	-2380.0	1364.0		772 S156	-5740.0	1364.0		892 S40	-8204.6	15.0	
533 S395	952.0	1229.0		653 S275	-2408.0	1229.0		773 S155	-5768.0	1229.0		893 S39	-8339.6	-12.0	
534 S394	924.0	1364.0		654 S274	-2436.0	1364.0		774 S154	-5796.0	1364.0		894 S38	-8204.6	-40.0	
535 S393	896.0	1229.0		655 S273	-2464.0	1229.0		775 S153	-5824.0	1229.0		895 S37	-8339.6	-68.0	
536 S392	868.0	1364.0		656 S272	-2492.0	1364.0		776 S152	-5852.0	1364.0		896 S36	-8204.6	-96.0	
537 S391	840.0	1229.0		657 S271	-2520.0	1229.0		777 S151	-5880.0	1229.0		897 S35	-8339.6	-124.0	
538 S390	812.0	1364.0		658 S270	-2548.0	1364.0		778 S150	-5908.0	1364.0		898 S34	-8204.6	-152.0	
539 S389	784.0	1229.0		659 S269	-2576.0	1229.0		779 S149	-5936.0	1229.0		899 S33	-8339.6	-180.0	
540 S388	756.0	1364.0		660 S268	-2604.0	1364.0		780 S148	-5964.0	1364.0		900 S32	-8204.6	-208.0	
541 S387	728.0	1229.0		661 S267	-2632.0	1229.0		781 S147	-5992.0	1229.0		901 S31	-8339.6	-236.0	
542 S386	700.0	1364.0		662 S266	-2660.0	1364.0		782 S146	-6020.0	1364.0		902 S30	-8204.6	-264.0	
543 S385	672.0	1229.0		663 S265	-2688.0	1229.0		783 S145	-6048.0	1229.0		903 S29	-8339.6	-292.0	
544 S384	644.0	1364.0		664 S264	-2716.0	1364.0		784 S144	-6076.0	1364.0		904 S28	-8204.6	-320.0	
545 S383	616.0	1229.0		665 S263	-2744.0	1229.0		785 S143	-6104.0	1229.0		905 S27	-8339.6	-348.0	
546 S382	588.0	1364.0		666 S262	-2772.0	1364.0		786 S142	-6132.0	1364.0		906 S26	-8204.6	-376.0	
547 S381	560.0	1229.0		667 S261	-2800.0	1229.0		787 S141	-6160.0	1229.0		907 S25	-8339.6	-404.0	
548 S380	532.0	1364.0		668 S260	-2828.0	1364.0		788 S140	-6188.0	1364.0		908 S24	-8204.6	-432.0	
549 S379	504.0	1229.0		669 S259	-2856.0	1229.0		789 S139	-6216.0	1229.0		909 S23	-8339.6	-460.0	
550 S378	476.0	1364.0		670 S258	-2884.0	1364.0		790 S138	-6244.0	1364.0		910 S22	-8204.6	-488.0	
551 S377	448.0	1229.0		671 S257	-2912.0	1229.0		791 S137	-6272.0	1229.0		911 S21	-8339.6	-516.0	
552 S376	420.0	1364.0		672 S256	-2940.0	1364.0		792 S136	-6300.0	1364.0		912 S20	-8204.6	-544.0	
553 S375	392.0	1229.0		673 S255	-2968.0	1229.0		793 S135	-6328.0	1229.0		913 S19	-8339.6	-572.0	
554 S374	364.0	1364.0		674 S254	-2996.0	1364.0		794 S134	-6356.0	1364.0		914 S18	-8204.6	-600.0	
555 S373	336.0	1229.0		675 S253	-3024.0	1229.0		795 S133	-6384.0	1229.0		915 S17	-8339.6	-628.0	
556 S372	308.0	1364.0		676 S252	-3052.0	1364.0		796 S132	-6412.0	1364.0		916 S16	-8204.6	-656.0	
557 S371	280.0	1229.0		677 S251	-3080.0	1229.0		797 S131	-6440.0	1229.0		917 S15	-8339.6	-684.0	
558 S370	252.0	1364.0		678 S250	-3108.0	1364.0		798 S130	-6468.0	1364.0		918 S14	-8204.6	-712.0	
559 S369	224.0	1229.0		679 S249	-31										

Bump Arrangement

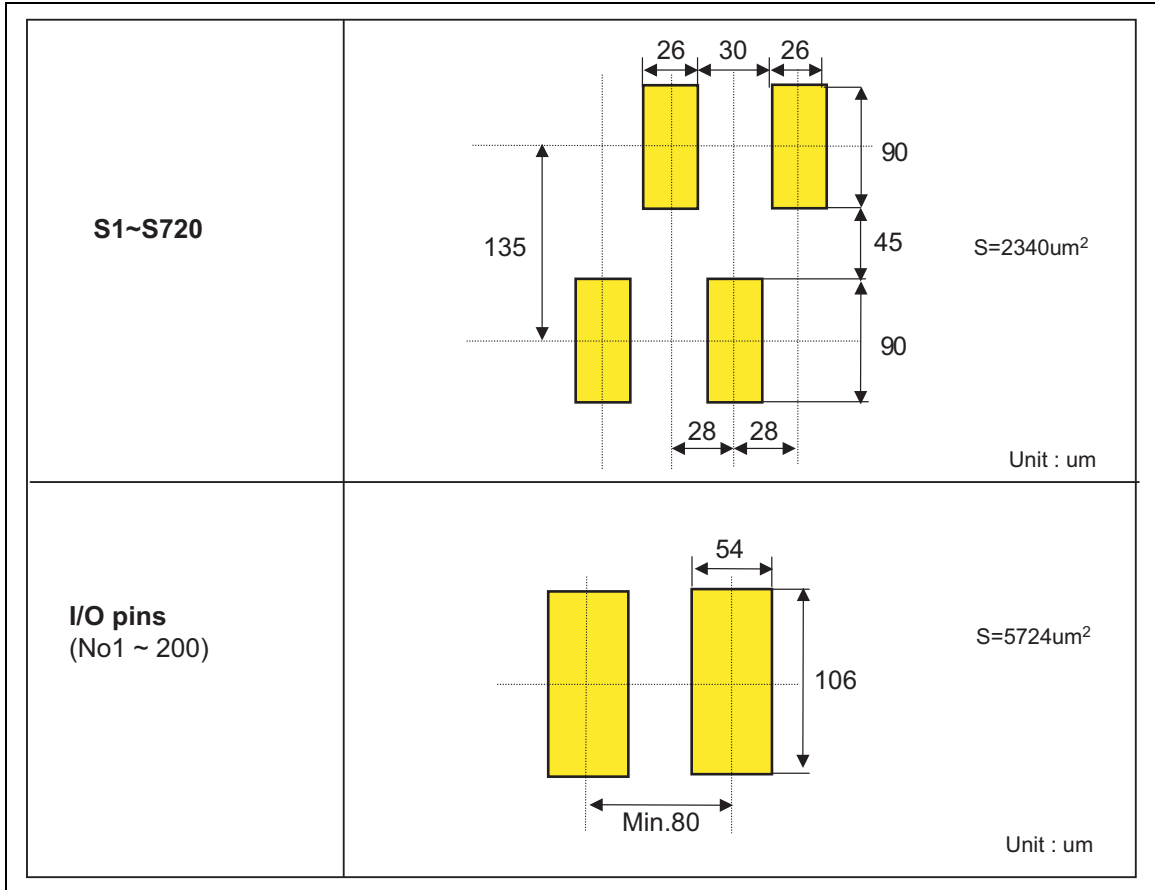

Example of connecting HD66781 and HD66783

Note:

This is an example of connecting HD66781 and HD66783 when these drivers are used as a set. The bottom views show an example of pin arrangements. See the pad coordination of each product for more accurate and detailed reference to the number of pads and the coordination.

The validity of this connection example is not confirmed. It is necessary to thoroughly check the operation and the display quality before use.

a-Si TFT

IOVcc = 1.7V~3.3V (HD66781)
 Vcc1 = 1.7~3.3V (HD66781)
 Vcc = 2.5~3.3V (HD66781)
 VCC = 1.7~3.3V (HD667P21)
 VCI = 2.5~3.3V (HD667P21)
 Supply a same potential to Vcc1 of HD66781 and VCC of HD66783.
 Make sure that IOVcc Vcc1 Vcc (HD66781).

To opposing electrodes on the panel(Vcom)

Source Electrode

Gate electrode

Gate electrode

Bottom View (Non Bump View)

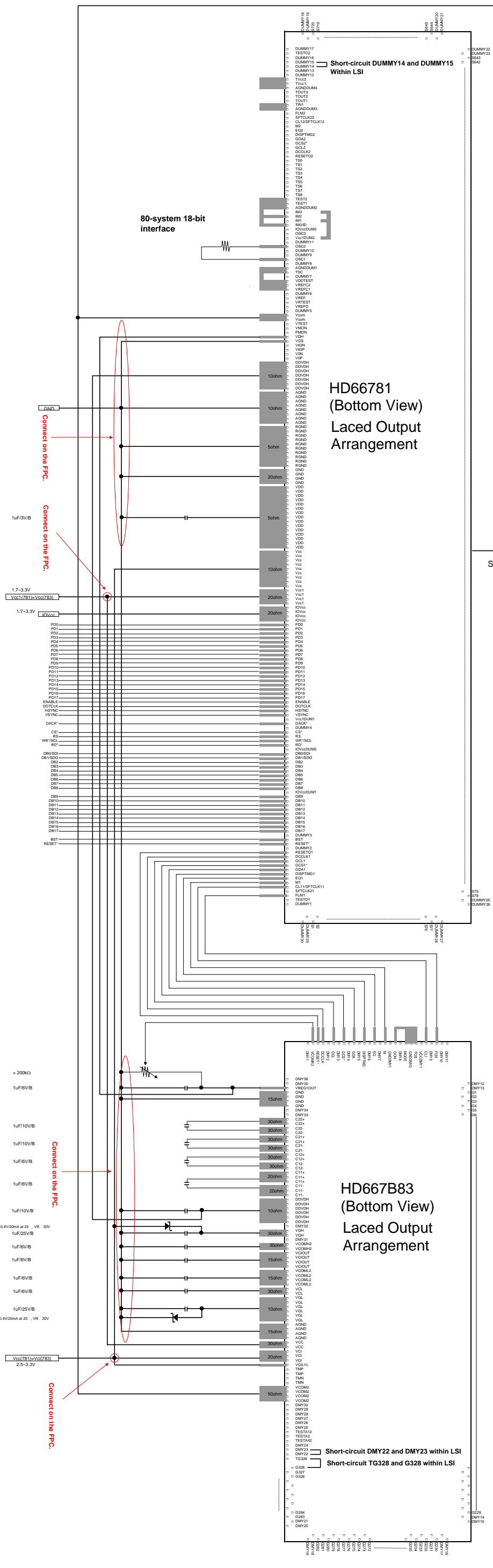
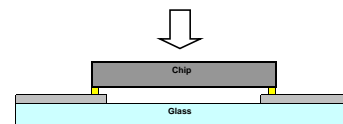

80-system 18-bit interface

HD66781 (Bottom View) Laced Output Arrangement

HD66783 (Bottom View) Laced Output Arrangement

Short-circuit DMY22 and DMY23 within LSI
 Short-circuit TG328 and G328 within LSI

Connect on the FPC.

Connect on the FPC.

Connect on the FPC.

Connect on the FPC.

Vcc1(781)=Vcc1(783)
 1.7-3.3V

Vcc1(781)=Vcc1(783)
 2.5-3.3V

> 200kΩ

1uF/10V/B

1uF/10V/B

1uF/10V/B

1uF/10V/B

1uF/10V/B

1uF/10V/B

1uF/10V/B

1uF/10V/B

1uF/10V/B

1uF/10V/B

1uF/10V/B

1uF/10V/B

1uF/10V/B

1uF/10V/B

1uF/10V/B

1uF/10V/B

1uF/10V/B

1uF/10V/B

1uF/10V/B

1uF/10V/B

1uF/10V/B

1uF/10V/B

1uF/10V/B

1uF/10V/B

1uF/10V/B

1uF/10V/B

1uF/10V/B

1uF/10V/B

1uF/10V/B

1uF/10V/B

1uF/10V/B

1uF/10V/B

1uF/10V/B

1uF/10V/B

1uF/10V/B

1uF/10V/B

1uF/10V/B

1uF/10V/B

1uF/10V/B

1uF/10V/B

1uF/10V/B

1uF/10V/B

1uF/10V/B

1uF/10V/B

1uF/10V/B

1uF/10V/B

1uF/10V/B

1uF/10V/B

1uF/10V/B

1uF/10V/B

1uF/10V/B

1uF/10V/B

1uF/10V/B

1uF/10V/B

1uF/10V/B

1uF/10V/B

1uF/10V/B

1uF/10V/B

1uF/10V/B

1uF/10V/B

1uF/10V/B

1uF/10V/B

1uF/10V/B

1uF/10V/B

1uF/10V/B

1uF/10V/B

1uF/10V/B

1uF/10V/B

1uF/10V/B

1uF/10V/B

1uF/10V/B

1uF/10V/B

1uF/10V/B

1uF/10V/B

1uF/10V/B

1uF/10V/B

1uF/10V/B

1uF/10V/B

1uF/10V/B

1uF/10V/B

1uF/10V/B

1uF/10V/B

1uF/10V/B

1uF/10V/B

1uF/10V/B

1uF/10V/B

1uF/10V/B

1uF/10V/B

1uF/10V/B

1uF/10V/B

1uF/10V/B

1uF/10V/B

1uF/10V/B

1uF/10V/B

1uF/10V/B

1uF/10V/B

1uF/10V/B

1uF/10V/B

1uF/10V/B

1uF/10V/B

1uF/10V/B

1uF/10V/B

1uF/10V/B

1uF/10V/B

1uF/10V/B

1uF/10V/B

1uF/10V/B

1uF/10V/B

1uF/10V/B

1uF/10V/B

1uF/10V/B

1uF/10V/B

1uF/10V/B

1uF/10V/B

1uF/10V/B

1uF/10V/B

1uF/10V/B

1uF/10V/B

1uF/10V/B

1uF/10V/B

1uF/10V/B

1uF/10V/B

1uF/10V/B

1uF/10V/B

1uF/10V/B

1uF/10V/B

1uF/10V/B

1uF/10V/B

1uF/10V/B

1uF/10V/B

1uF/10V/B

1uF/10V/B

1uF/10V/B

1uF/10V/B

1uF/10V/B

1uF/10V/B

1uF/10V/B

1uF/10V/B

1uF/10V/B

1uF/10V/B

1uF/10V/B

1uF/10V/B

1uF/10V/B

1uF/10V/B

1uF/10V/B

1uF/10V/B

1uF/10V/B

1uF/10V/B

1uF/10V/B

1uF/10V/B

1uF/10V/B

1uF/10V/B

1uF/10V/B

1uF/10V/B

1uF/10V/B

1uF/10V/B

1uF/10V/B

1uF/10V/B

1uF/10V/B

1uF/10V/B

1uF/10V/B

1uF/10V/B

1uF/10V/B

1uF/10V/B

1uF/10V/B

1uF/10V/B

1uF/10V/B

1uF/10V/B

1uF/10V/B

1uF/10V/B

1uF/10V/B

1uF/10V/B

1uF/10V/B

1uF/10V/B

1uF/10V/B

1uF/10V/B

1uF/10V/B

1uF/10V/B

1uF/10V/B

1uF/10V/B

1uF/10V/B

1uF/10V/B

1uF/10V/B

1uF/10V/B

1uF/10V/B

1uF/10V/B

1uF/10V/B

1uF/10V/B

1uF/10V/B

1uF/10V/B

1uF/10V/B

1uF/10V/B

1uF/10V/B

1uF/10V/B

1uF/10V/B

1uF/10V/B

1uF/10V/B

1uF/10V/B

1uF/10V/B

1uF/10V/B

1uF/10V/B

1uF/10V/B

1uF/10V/B

1uF/10V/B

1uF/10V/B

1uF/10V/B

1uF/10V/B

1uF/10V/B

1uF/10V/B

1uF/10V/B

1uF/10V/B

1uF/10V/B

1uF/10V/B

1uF/10V/B

1uF/10V/B

1uF/10V/B

1uF/10V/B

1uF/10V/B

1uF/10V/B

1uF/10V/B

1uF/10V/B

1uF/10V/B

1uF/10V/B

1uF/10V/B

1uF/10V/B

1uF/10V/B

1uF/10V/B

Example of connecting HD66781 and HD667P21

To opposing electrodes on the panel(Vcom)

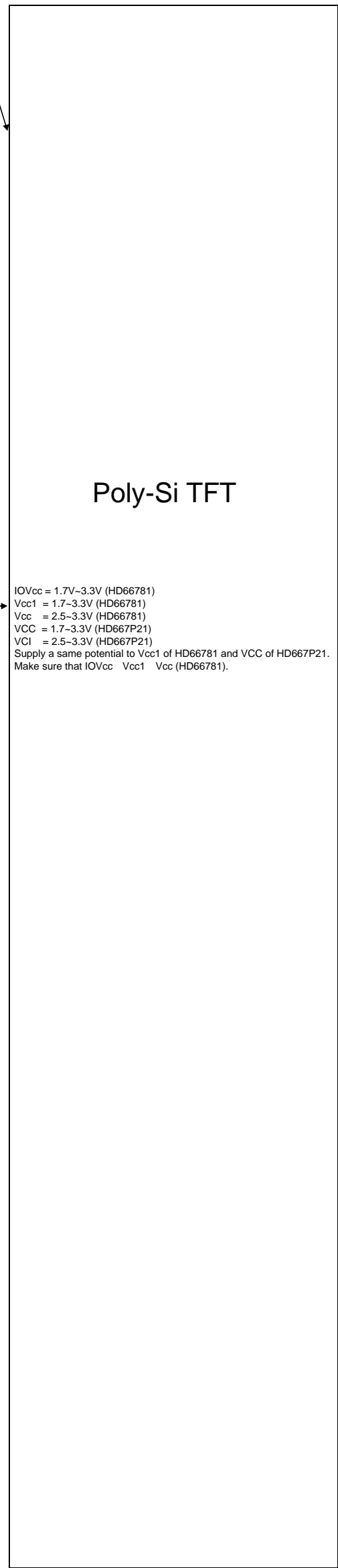

IOVcc = 1.7V~3.3V (HD66781)
 Vcc1 = 1.7~3.3V (HD66781)
 Vcc = 2.5~3.3V (HD66781)
 VCC = 1.7~3.3V (HD667P21)
 VCI = 2.5~3.3V (HD667P21)
 Supply a same potential to Vcc1 of HD66781 and VCC of HD667P21.
 Make sure that IOVcc = Vcc1 = Vcc (HD66781).

80-system 18-bit interface

HD66781
 (Bottom View)
 Laced Output

HD667P21
 (Bottom View)

Bottom View (Non Bump View)

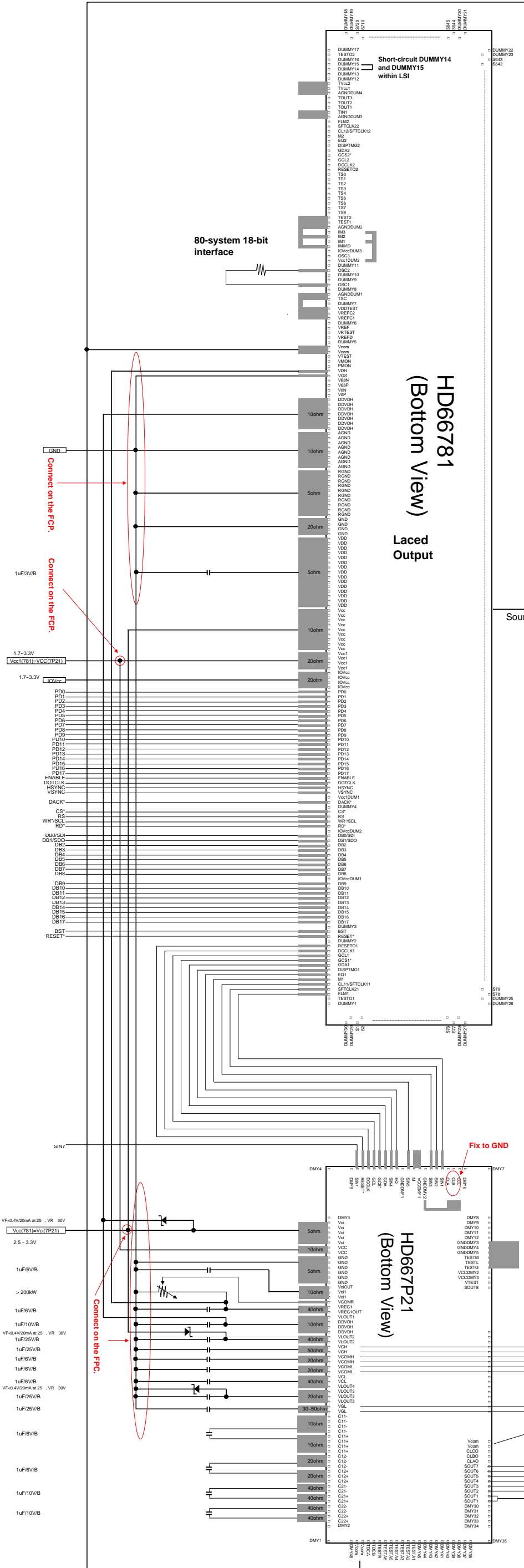
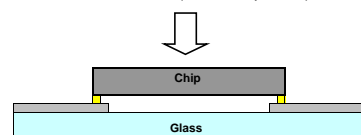

Connect on the FPC.

Connect on the FPC.

Connect on the FPC.

Fix to GND

Block Function

(1) System interface

The HD66781 has 2 kinds of high-speed system interfaces: 80-system 18-/16-/9-/8-bit bus interfaces and Serial Peripheral Interface (SPI) ports. The 8-bit bus interface is compliant to both big and little endian data outputs from the microcomputer. The interface mode is selected with the IM3-0 pins.

The HD66781 incorporates 16-bit index register (IR), write-data register (WDR), and 16-bit read-data register (RDR). The IR stores index information from the control register and GRAM. The WDR temporarily stores data to write into the control register and GRAM, and the RDR temporarily stores data read from GRAM. Data written into GRAM from MPU is first written into the WDR and then automatically written to GRAM by internal operation. Since data are read through the RDR from GRAM, the data that are read out first are invalid and the ensuing data are read out normally.

The execution time for the instructions other than oscillation start is 0-clock cycle, which enables writing instructions consecutively.

Table 1 Register Selection (8/9/16/18 parallel interface)

80-system bus			Operation
WR*	RD*	RS	
0	1	0	Write index to IR.
1	0	0	Read internal status
0	1	1	Write to control registers/GRAM through WDR
1	0	1	Read from GRAM through RDR

Table 2 Register Selection (SPI)

Start byte		Operation
RW	RS	
0	0	Write index to IR.
1	0	Read internal status
0	0	Write to control registers/GRAM through WDR
1	1	Read from GRAM through RDR

The HD66781 incorporates DMA single address mode interface to keep control on the bus occupation ratio when transferring a large volume of data. The DMA controller supporting a single address mode controls the DACK pin of HD66781 to recognize out-enable signal (OE) for SRAM as a write strobe signal. The HD66781 enables data transfer with less bus cycle by using a same bus cycle for a readout operation from an external SRAM and a write operation to HD66781. See “DMA transfer single address mode” (p.131) for details on controlling the execution of transfer and conditions in using this mode.

(2) External Display Interface (RGB I/F, VSYNC I/F)

The HD66781 incorporates RGB and VSYNC interfaces as an external interface for displaying moving pictures. When the RGB-I/F is selected, the operation is synchronized with externally supplied signals, VSYN C, HSYNC, and DOTCLK. The display data (PD17-0) are written in accordance with the data enable signal (ENABLE). Accordingly, the display on the screen does not flicker when RAM data are being updated internally.

When the VSYNC-I/F is selected, the operation is synchronized with internal clocks except frame synchronization, which is synchronized with VSYNC signal. The display data is written to GRAM through a system interface. In this case, there are constraints on the speed and methods of updating RAM data when the VSYNC I/F is selected. For details, see the “External Display Interface” section (p.139).

The switch from and to the system interface is made through instructions. An optimum interface can be selected for the kind of display (still and/or moving pictures). The display data are all written to GRAM through the RGB-I/F. This enables transmission of data only when the display on the screen is being updated, and thereby reduces the data transmission as well as consumption of power when a moving picture is displayed.

(3) Address Counter (AC)

The address counter (AC) assigns the address to GRAM. When a set-address instruction is written to the IR, the address information is sent from the IR to the AC. After writing data into GRAM, the AC is automatically incremented or decremented by 1, while after data are read from GRAM, the AC is not updated. Window address function enables data write only in the rectangular area of GRAM specified by the window address.

(4) Graphic RAM (GRAM)

GRAM is a graphics RAM that stores 224,640-byte bit-pattern data, where one pixel is expressed by 18 bits. Maximum 240 RGB x 320 can be displayed by using both main/sub panels. Besides data of 240 RGB x 320 lines for a base image, it can store OSD data of 240 RGB x 96 lines. The allocation of the numbers of lines for a base image and an OSD image is changeable.

(5) Grayscale Voltage Generation Circuit

The grayscale voltage generation circuit generates an LCD drive voltage according to the grayscale level set in the γ -correction register. Simultaneously 262,144 colors are available for display.

(6) Timing generator

Timing generator generates a timing signal for the operation of internal circuits such as GRAM. The timing for display operation such as RAM read and the internal operation timing such as access from MPU are generated in a way to avoid mutual interfere. Also the signals interfacing with gate driver/power supply IC (M, FLM, CL1/SFTCLK1, SFTCLK2, EQ, DCCLK, and DISPTMG) are generated.

(7) Oscillation Circuit (OSC)

The HD66781 generates R-C oscillation simply by placing an external oscillation-resistor between the OSC1 and OSC2 pins. The oscillation frequency is changeable with the value of external resistor. Adjust oscillation frequency in accordance to an operation voltage, display size, and frame frequency. During the standby mode, the R-C oscillation is halted to reduce power consumption. For details, see "Oscillation Circuit" (p.173).

(8) Liquid Crystal Display Driver Circuit

The LCD driver circuit consists of a 720-output source driver (S1 ~ S720). Display pattern data are latched when 720-bit data arrive. The latched data controls the source driver and generates drive waveforms. The shift direction of 720-bit output from source driver is changeable with SS bit. Select an appropriate shift direction for the assembly.

(9) Gate driver/power supply IC interfacing circuit

Gate driver/power supply IC interfacing circuit is a serial interface circuit to interface with the HD66783 and the HD667P21. When making settings for instructions to the HD66783 or the HD667P21 through the HD66781, values set in the register of HD66781 are transferred through this serial interface circuit. The transfer starts by making a serial transfer ENABLE setting. Both transfer of instruction to the HD66783/HD667P21 and read out from the HD66781 are impossible during standby mode. For details, see "Gate Driver/Power Supply IC interface control" (p.70).

(10) Internal Logic Power Supply Regulator

Internal logic power supply regulator generates power supply VDD for the internal logic.

GRAM Address MAP

Relation between GRAM addresses and Screen positions (SS=0, BGR=0)

Table 3

S/ G pins		S1	S2	S3	S4	S5	S6	S7	S8	S9	S10	S11	S12	S709	S710	S711	S712	S713	S714	S715	S716	S717	S718	S719	S720
GS=0	GS=1	PD17-0	PD17-0	PD17-0	PD17-0	PD17-0	PD17-0	PD17-0	PD17-0	PD17-0	PD17-0	PD17-0	PD17-0	PD17-0	PD17-0	PD17-0	PD17-0	PD17-0	PD17-0	PD17-0	PD17-0	PD17-0	PD17-0	PD17-0	PD17-0
G1	G328	h00000	h00001	h00002	h00003	h00004	h00005	h00006	h00007	h00008	h00009	h00010	h00011	h00012	h00013	h00014	h00015	h00016	h00017	h00018	h00019	h00020	h00021	h00022	h00023	h00024
G2	G327	h00100	h00101	h00102	h00103	h00104	h00105	h00106	h00107	h00108	h00109	h00110	h00111	h00112	h00113	h00114	h00115	h00116	h00117	h00118	h00119	h00120	h00121	h00122	h00123	h00124
G3	G326	h00200	h00201	h00202	h00203	h00204	h00205	h00206	h00207	h00208	h00209	h00210	h00211	h00212	h00213	h00214	h00215	h00216	h00217	h00218	h00219	h00220	h00221	h00222	h00223	h00224
G4	G325	h00300	h00301	h00302	h00303	h00304	h00305	h00306	h00307	h00308	h00309	h00310	h00311	h00312	h00313	h00314	h00315	h00316	h00317	h00318	h00319	h00320	h00321	h00322	h00323	h00324
G5	G324	h00400	h00401	h00402	h00403	h00404	h00405	h00406	h00407	h00408	h00409	h00410	h00411	h00412	h00413	h00414	h00415	h00416	h00417	h00418	h00419	h00420	h00421	h00422	h00423	h00424
G6	G323	h00500	h00501	h00502	h00503	h00504	h00505	h00506	h00507	h00508	h00509	h00510	h00511	h00512	h00513	h00514	h00515	h00516	h00517	h00518	h00519	h00520	h00521	h00522	h00523	h00524
G7	G322	h00600	h00601	h00602	h00603	h00604	h00605	h00606	h00607	h00608	h00609	h00610	h00611	h00612	h00613	h00614	h00615	h00616	h00617	h00618	h00619	h00620	h00621	h00622	h00623	h00624
G8	G321	h00700	h00701	h00702	h00703	h00704	h00705	h00706	h00707	h00708	h00709	h00710	h00711	h00712	h00713	h00714	h00715	h00716	h00717	h00718	h00719	h00720	h00721	h00722	h00723	h00724
G9	G320	h00800	h00801	h00802	h00803	h00804	h00805	h00806	h00807	h00808	h00809	h00810	h00811	h00812	h00813	h00814	h00815	h00816	h00817	h00818	h00819	h00820	h00821	h00822	h00823	h00824
G10	G319	h00900	h00901	h00902	h00903	h00904	h00905	h00906	h00907	h00908	h00909	h00910	h00911	h00912	h00913	h00914	h00915	h00916	h00917	h00918	h00919	h00920	h00921	h00922	h00923	h00924
G11	G318	h00A00	h00A01	h00A02	h00A03	h00A04	h00A05	h00A06	h00A07	h00A08	h00A09	h00A10	h00A11	h00A12	h00A13	h00A14	h00A15	h00A16	h00A17	h00A18	h00A19	h00A20	h00A21	h00A22	h00A23	h00A24
G12	G317	h00B00	h00B01	h00B02	h00B03	h00B04	h00B05	h00B06	h00B07	h00B08	h00B09	h00B10	h00B11	h00B12	h00B13	h00B14	h00B15	h00B16	h00B17	h00B18	h00B19	h00B20	h00B21	h00B22	h00B23	h00B24
G13	G316	h00C00	h00C01	h00C02	h00C03	h00C04	h00C05	h00C06	h00C07	h00C08	h00C09	h00C10	h00C11	h00C12	h00C13	h00C14	h00C15	h00C16	h00C17	h00C18	h00C19	h00C20	h00C21	h00C22	h00C23	h00C24
G14	G315	h00D00	h00D01	h00D02	h00D03	h00D04	h00D05	h00D06	h00D07	h00D08	h00D09	h00D10	h00D11	h00D12	h00D13	h00D14	h00D15	h00D16	h00D17	h00D18	h00D19	h00D20	h00D21	h00D22	h00D23	h00D24
G15	G314	h00E00	h00E01	h00E02	h00E03	h00E04	h00E05	h00E06	h00E07	h00E08	h00E09	h00E10	h00E11	h00E12	h00E13	h00E14	h00E15	h00E16	h00E17	h00E18	h00E19	h00E20	h00E21	h00E22	h00E23	h00E24
G16	G313	h00F00	h00F01	h00F02	h00F03	h00F04	h00F05	h00F06	h00F07	h00F08	h00F09	h00F10	h00F11	h00F12	h00F13	h00F14	h00F15	h00F16	h00F17	h00F18	h00F19	h00F20	h00F21	h00F22	h00F23	h00F24
G17	G312	h01000	h01001	h01002	h01003	h01004	h01005	h01006	h01007	h01008	h01009	h01010	h01011	h01012	h01013	h01014	h01015	h01016	h01017	h01018	h01019	h01020	h01021	h01022	h01023	h01024
G18	G311	h01100	h01101	h01102	h01103	h01104	h01105	h01106	h01107	h01108	h01109	h01110	h01111	h01112	h01113	h01114	h01115	h01116	h01117	h01118	h01119	h01120	h01121	h01122	h01123	h01124
G19	G310	h01200	h01201	h01202	h01203	h01204	h01205	h01206	h01207	h01208	h01209	h01210	h01211	h01212	h01213	h01214	h01215	h01216	h01217	h01218	h01219	h01220	h01221	h01222	h01223	h01224
G20	G309	h01300	h01301	h01302	h01303	h01304	h01305	h01306	h01307	h01308	h01309	h01310	h01311	h01312	h01313	h01314	h01315	h01316	h01317	h01318	h01319	h01320	h01321	h01322	h01323	h01324
.....	
G301	G28	h12C00	h12C01	h12C02	h12C03	h12C04	h12C05	h12C06	h12C07	h12C08	h12C09	h12C10	h12C11	h12C12	h12C13	h12C14	h12C15	h12C16	h12C17	h12C18	h12C19	h12C20	h12C21	h12C22	h12C23	h12C24
G302	G27	h12D00	h12D01	h12D02	h12D03	h12D04	h12D05	h12D06	h12D07	h12D08	h12D09	h12D10	h12D11	h12D12	h12D13	h12D14	h12D15	h12D16	h12D17	h12D18	h12D19	h12D20	h12D21	h12D22	h12D23	h12D24
G303	G26	h12E00	h12E01	h12E02	h12E03	h12E04	h12E05	h12E06	h12E07	h12E08	h12E09	h12E10	h12E11	h12E12	h12E13	h12E14	h12E15	h12E16	h12E17	h12E18	h12E19	h12E20	h12E21	h12E22	h12E23	h12E24
G304	G25	h12F00	h12F01	h12F02	h12F03	h12F04	h12F05	h12F06	h12F07	h12F08	h12F09	h12F10	h12F11	h12F12	h12F13	h12F14	h12F15	h12F16	h12F17	h12F18	h12F19	h12F20	h12F21	h12F22	h12F23	h12F24
G305	G24	h13000	h13001	h13002	h13003	h13004	h13005	h13006	h13007	h13008	h13009	h13010	h13011	h13012	h13013	h13014	h13015	h13016	h13017	h13018	h13019	h13020	h13021	h13022	h13023	h13024
G306	G23	h13100	h13101	h13102	h13103	h13104	h13105	h13106	h13107	h13108	h13109	h13110	h13111	h13112	h13113	h13114	h13115	h13116	h13117	h13118	h13119	h13120	h13121	h13122	h13123	h13124
G307	G22	h13200	h13201	h13202	h13203	h13204	h13205	h13206	h13207	h13208	h13209	h13210	h13211	h13212	h13213	h13214	h13215	h13216	h13217	h13218	h13219	h13220	h13221	h13222	h13223	h13224
G308	G21	h13300	h13301	h13302	h13303	h13304	h13305	h13306	h13307	h13308	h13309	h13310	h13311	h13312	h13313	h13314	h13315	h13316	h13317	h13318	h13319	h13320	h13321	h13322	h13323	h13324
G309	G20	h13400	h13401	h13402	h13403	h13404	h13405	h13406	h13407	h13408	h13409	h13410	h13411	h13412	h13413	h13414	h13415	h13416	h13417	h13418	h13419	h13420	h13421	h13422	h13423	h13424
G310	G19	h13500	h13501	h13502	h13503	h13504	h13505	h13506	h13507	h13508	h13509	h13510	h13511	h13512	h13513	h13514	h13515	h13516	h13517	h13518	h13519	h13520	h13521	h13522	h13523	h13524
G311	G18	h13600	h13601	h13602	h13603	h13604	h13605	h13606	h13607	h13608	h13609	h13610	h13611	h13612	h13613	h13614	h13615	h13616	h13617	h13618	h13619	h13620	h13621	h13622	h13623	h13624
G312	G17	h13700	h13701	h13702	h13703	h13704	h13705	h13706	h13707	h13708	h13709	h13710	h13711	h13712	h13713	h13714	h13715	h13716	h13717	h13718	h13719	h13720	h13721	h13722	h13723	h13724
G313	G16	h13800	h13801	h13802	h13803	h13804	h13805	h13806	h13807	h13808	h13809	h13810	h13811	h13812	h13813	h13814	h13815	h13816	h13817	h13818	h13819	h13820	h13821	h13822	h13823	h13824
G314	G15	h13900	h13901	h13902	h13903	h13904	h13905	h13906	h13907	h13908	h13909	h13910	h13911	h13912	h13913	h13914	h13915	h13916	h13917	h13918	h13919	h13920	h13921	h13922	h13923	h13924
G315	G14	h13A00	h13A01	h13A02	h13A03	h13A04	h13A05	h13A06	h13A07	h13A08	h13A09	h13A10	h13A11	h13A12	h13A13	h13A14	h13A15	h13A16	h13A17	h13A18	h13A19	h13A20	h13A21	h13A22	h13A23	h13A24
G316	G13	h13B00	h13B01	h13B02	h13B03	h13B04</																				

Relation between GRAM data and Display data (SS=0, BGR=0)

The following figure illustrates the relationship between data on GRAM and display data through each interface.

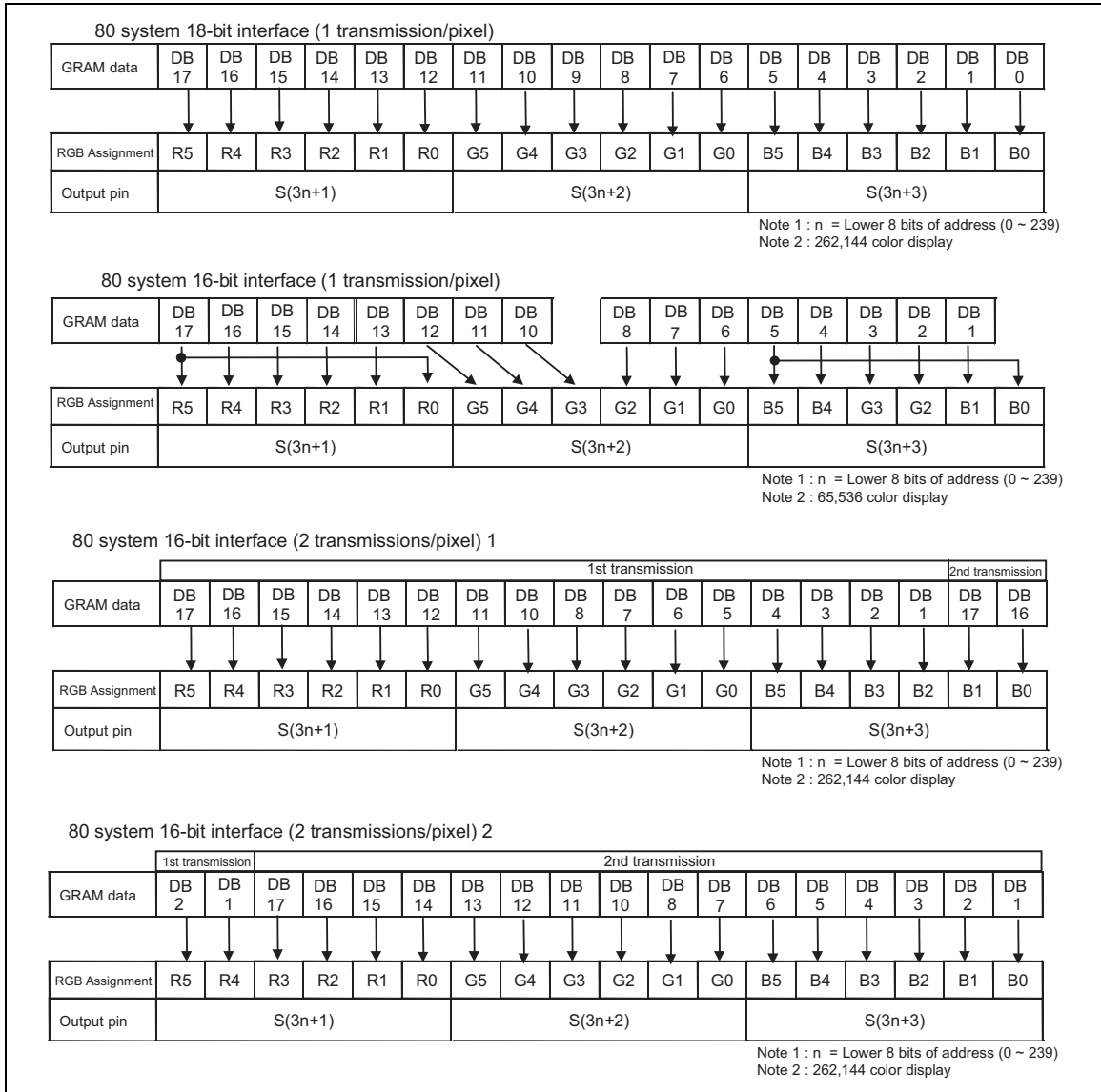

80 system 9-bit interface (2 transmissions/pixel)

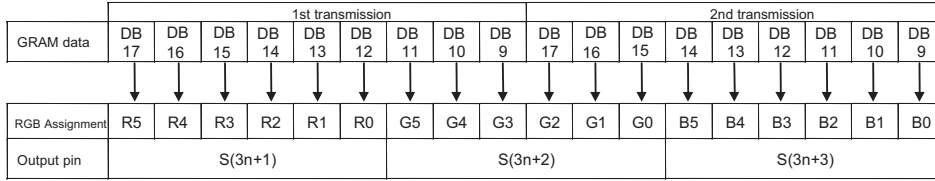

Note 1 : n = Lower 8 bits of address (0 ~ 239)
 Note 2 : 262,144 color display

80 system 8-bit interface (big endian)/ SPI (2 transmissions/pixel)

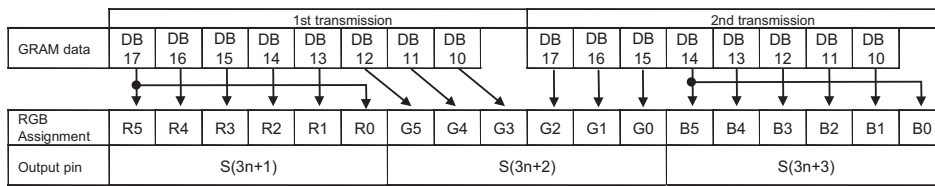

Note 1 : n = lower 8 bits of address (0 ~ 239)
 Note 2 : 65,536 color display

80 system 8-bit interface / (3 transmissions/pixel) 1

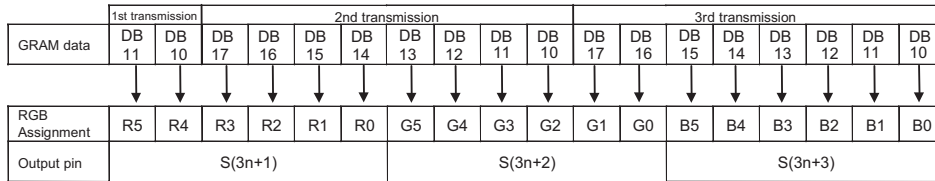

Note 1 : n = lower 8 bits of address (0 ~ 239)
 Note 2 : 262,144 color display

80 system 8-bit interface / (3 transmissions/pixel) 2

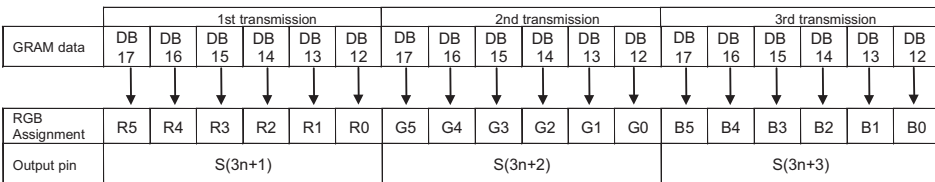

Note 1 : n = lower 8 bits of address (0 ~ 239)
 Note 2 : 262,144 color display
 Note 3 : Upper 2-bit data of each transmission are not used.

80 system 8-bit interface (little endian) / (2 transmissions/pixel)

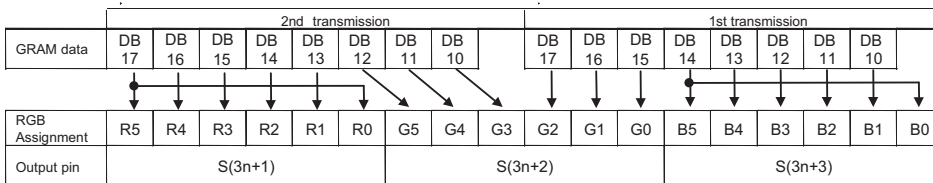

Note 1 : n = lower 8 bits of address (0 ~ 239)
 Note 2 : 65,536 color display

80-system 9/8-bit interface (SS = 0, BGR = 0)

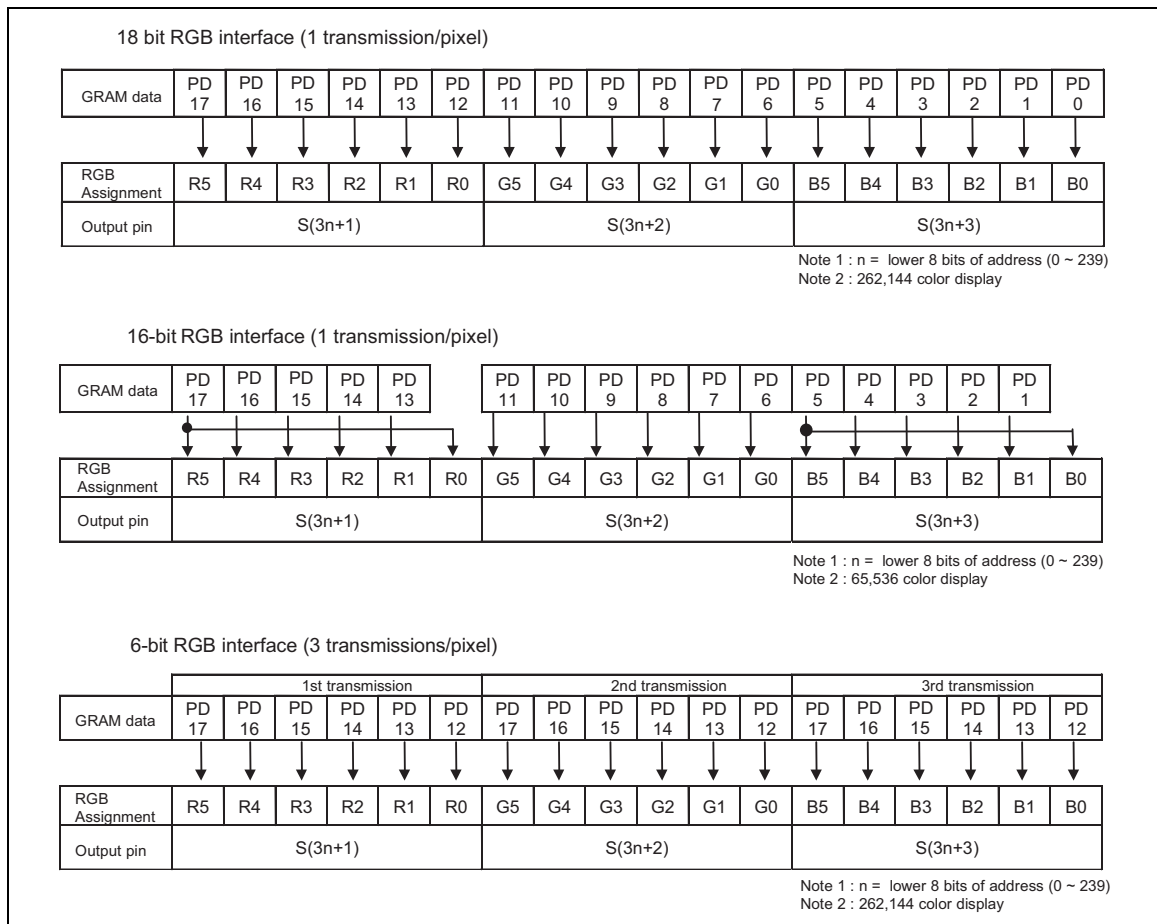

RGB interface (SS = 0, BGR = 0)

Relation between GRAM address and Screen position (SS=1, BGR=1)

Table 4

S/ G pins		S1	S2	S3	S4	S5	S6	S7	S8	S9	S10	S11	S12	S709	S710	S711	S712	S713	S714	S715	S716	S717	S718	S719	S720
GS=0	GS=1	PD17-0	PD17-0	PD17-0	PD17-0	PD17-0	PD17-0	PD17-0	PD17-0	PD17-0	PD17-0	PD17-0	PD17-0	PD17-0	PD17-0	PD17-0	PD17-0	PD17-0	PD17-0	PD17-0	PD17-0	PD17-0	PD17-0	PD17-0	PD17-0
G1	G328	h000EF	h000EE	h000ED	h000EC	h00003	h00002	h00001	h00000																
G2	G327	h001EF	h001EE	h001ED	h001EC	h00103	h00102	h00101	h00100																
G3	G326	h002EF	h002EE	h002ED	h002EC	h00203	h00202	h00201	h00200																
G4	G325	h003EF	h003EE	h003ED	h003EC	h00303	h00302	h00301	h00300																
G5	G324	h004EF	h004EE	h004ED	h004EC	h00403	h00402	h00401	h00400																
G6	G323	h005EF	h005EE	h005ED	h005EC	h00503	h00502	h00501	h00500																
G7	G322	h006EF	h006EE	h006ED	h006EC	h00603	h00602	h00601	h00600																
G8	G321	h007EF	h007EE	h007ED	h007EC	h00703	h00702	h00701	h00700																
G9	G320	h008EF	h008EE	h008ED	h008EC	h00803	h00802	h00801	h00800																
G10	G319	h009EF	h009EE	h009ED	h009EC	h00903	h00902	h00901	h00900																
G11	G318	h00AEF	h00AEE	h00AED	h00AEC	h00A03	h00A02	h00A01	h00A00																
G12	G317	h00BEF	h00BEE	h00BED	h00BEC	h00B03	h00B02	h00B01	h00B00																
G13	G316	h00CEF	h00CEE	h00CED	h00CEC	h00C03	h00C02	h00C01	h00C00																
G14	G315	h00DEF	h00DEE	h00DED	h00DEC	h00D03	h00D02	h00D01	h00D00																
G15	G314	h00EEF	h00EEE	h00EED	h00EEC	h00E03	h00E02	h00E01	h00E00																
G16	G313	h00FEF	h00FEE	h00FED	h00FEC	h00F03	h00F02	h00F01	h00F00																
G17	G312	h010EF	h010EE	h010ED	h010EC	h01003	h01002	h01001	h01000																
G18	G311	h011EF	h011EE	h011ED	h011EC	h01103	h01102	h01101	h01100																
G19	G310	h012EF	h012EE	h012ED	h012EC	h01203	h01202	h01201	h01200																
G20	G309	h013EF	h013EE	h013ED	h013EC	h01303	h01302	h01301	h01300																
:	:	:	:	:	:	:	:	:	:	:	:	:	:	:	:	:	:	:	:	:	:	:	:	:	:	:
G301	G28	h12CEF	h12CEE	h12CED	h12CEC	h12C03	h12C02	h12C01	h12C00																
G302	G27	h12DEF	h12DEE	h12DED	h12DEC	h12D03	h12D02	h12D01	h12D00																
G303	G26	h12EEF	h12EEE	h12EED	h12EEC	h12E03	h12E02	h12E01	h12E00																
G304	G25	h12FEF	h12FEE	h12FED	h12FEC	h12F03	h12F02	h12F01	h12F00																
G305	G24	h130EF	h130EE	h130ED	h130EC	h13003	h13002	h13001	h13000																
G306	G23	h131EF	h131EE	h131ED	h131EC	h13103	h13102	h13101	h13100																
G307	G22	h132EF	h132EE	h132ED	h132EC	h13203	h13202	h13201	h13200																
G308	G21	h133EF	h133EE	h133ED	h133EC	h13303	h13302	h13301	h13300																
G309	G20	h134EF	h134EE	h134ED	h134EC	h13403	h13402	h13401	h13400																
G310	G19	h135EF	h135EE	h135ED	h135EC	h13503	h13502	h13501	h13500																
G311	G18	h136EF	h136EE	h136ED	h136EC	h13603	h13602	h13601	h13600																
G312	G17	h137EF	h137EE	h137ED	h137EC	h13703	h13702	h13701	h13700																
G313	G16	h138EF	h138EE	h138ED	h138EC	h13803	h13802	h13801	h13800																
G314	G15	h139EF	h139EE	h139ED	h139EC	h13903	h13902	h13901	h13900																
G315	G14	h13AEF	h13AEE	h13AED	h13AEC	h13A03	h13A02	h13A01	h13A00																
G316	G13	h13BEF	h13BEE	h13BED	h13BEC	h13B03	h13B02	h13B01	h13B00																
G317	G12	h13CEF	h13CEE	h13CED	h13CEC	h13C03	h13C02	h13C01	h13C00																
G318	G11	h13DEF	h13DEE	h13DED	h13DEC	h13D03	h13D02	h13D01	h13D00																
G319	G10	h13EEF	h13EEE	h13EED	h13EEC	h13E03	h13E02	h13E01	h13E00																
G320	G9	h13FEF	h13FEE	h13FED	h13FEC	h13F03	h13F02	h13F01	h13F00																

Relation between GRAM data and Display data (SS=1, BGR=1)

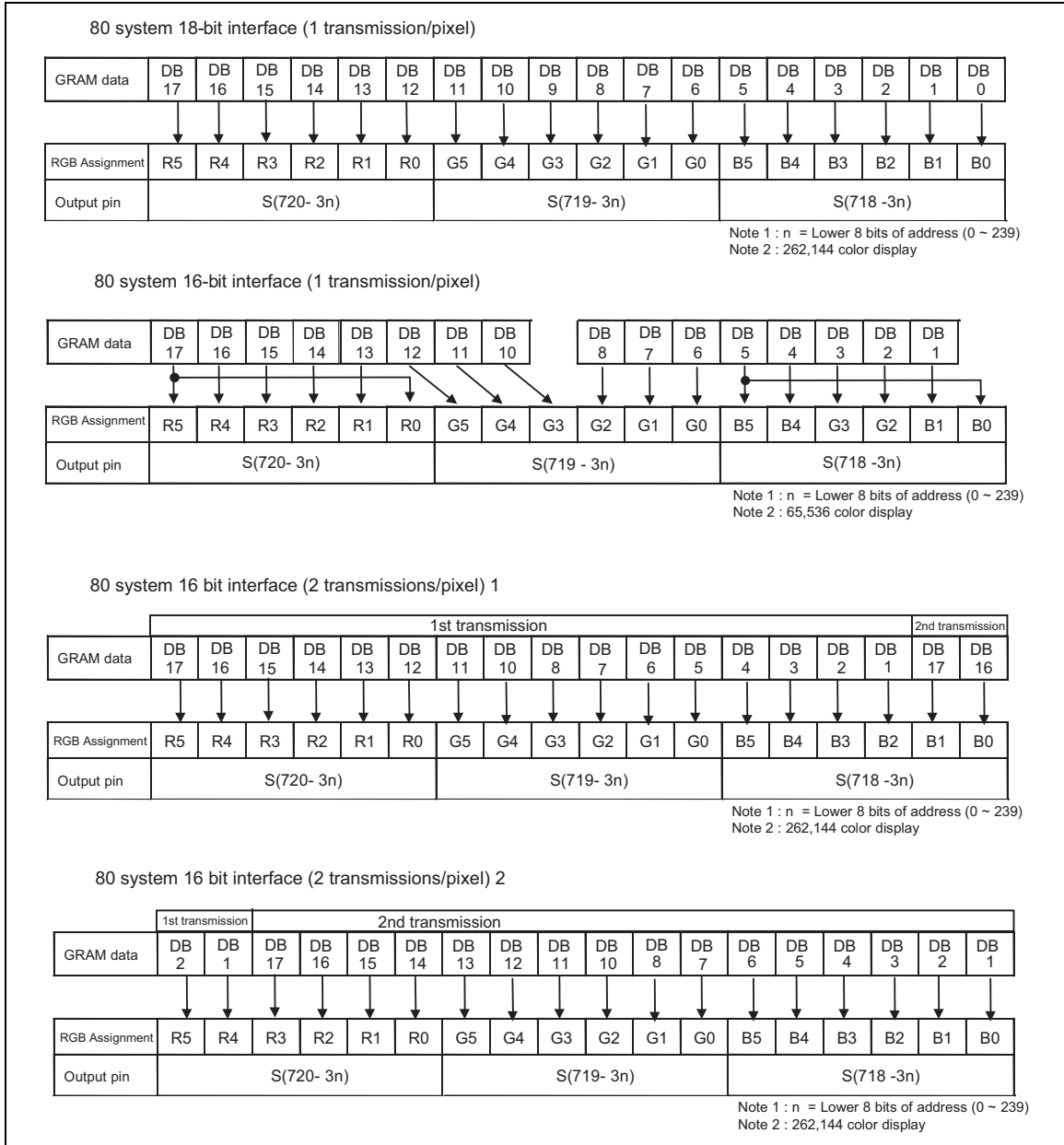

80 system 9-bit interface (2 transmissions/pixel)

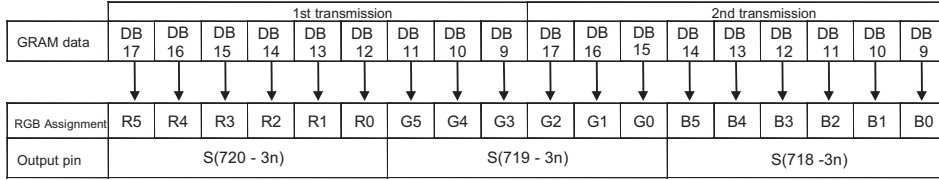

Note 1 : n = Lower 8 bits of address (0 ~ 239)
 Note 2 : 262,144 color display

80 system 8-bit interface (big endian) / SPI (2 transmissions/pixel)

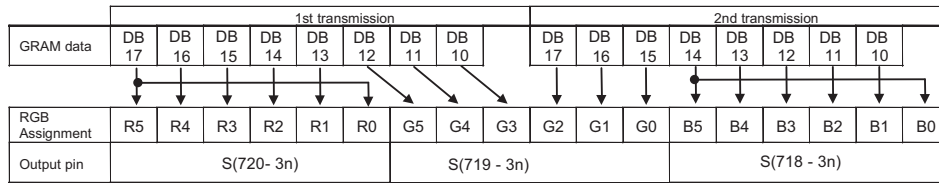

Note 1 : n = lower 8 bits of address (0 ~ 239)
 Note 2 : 65,536 color display

80 system 8-bit interface / (3 transmissions/pixel) 1

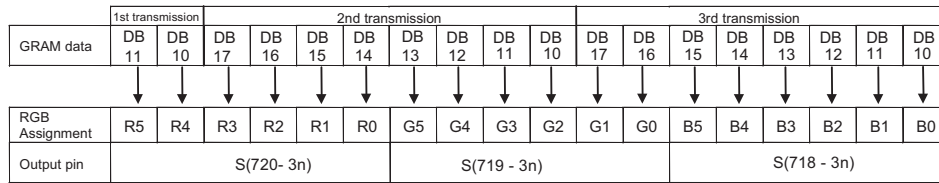

Note 1 : n = lower 8 bits of address (0 ~ 239)
 Note 2 : 262,144 color display

80 system 8-bit interface / (3 transmissions/pixel) 2

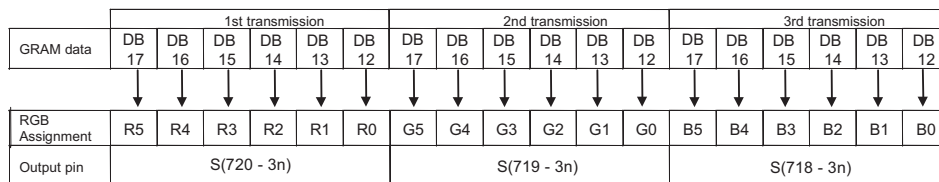

Note 1 : n = lower 8 bits of address (0 ~ 239)
 Note 2 : 262,144 color display
 Note 3 : Upper 2-bit data of each transmission are not used.

80 system 8-bit interface (little endian) / (2 transmissions/pixel)

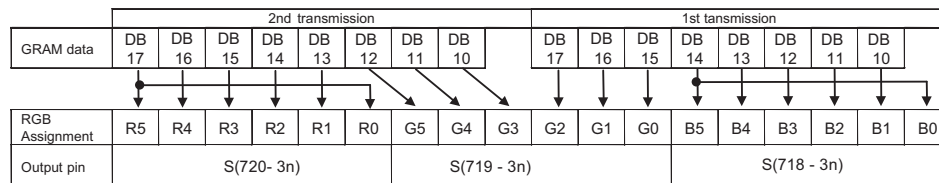

Note 1 : n = lower 8 bits of address (0 ~ 239)
 Note 2 : 65,536 color display

80-system 9/8-bit interface (SS = 1, BGR = 1)

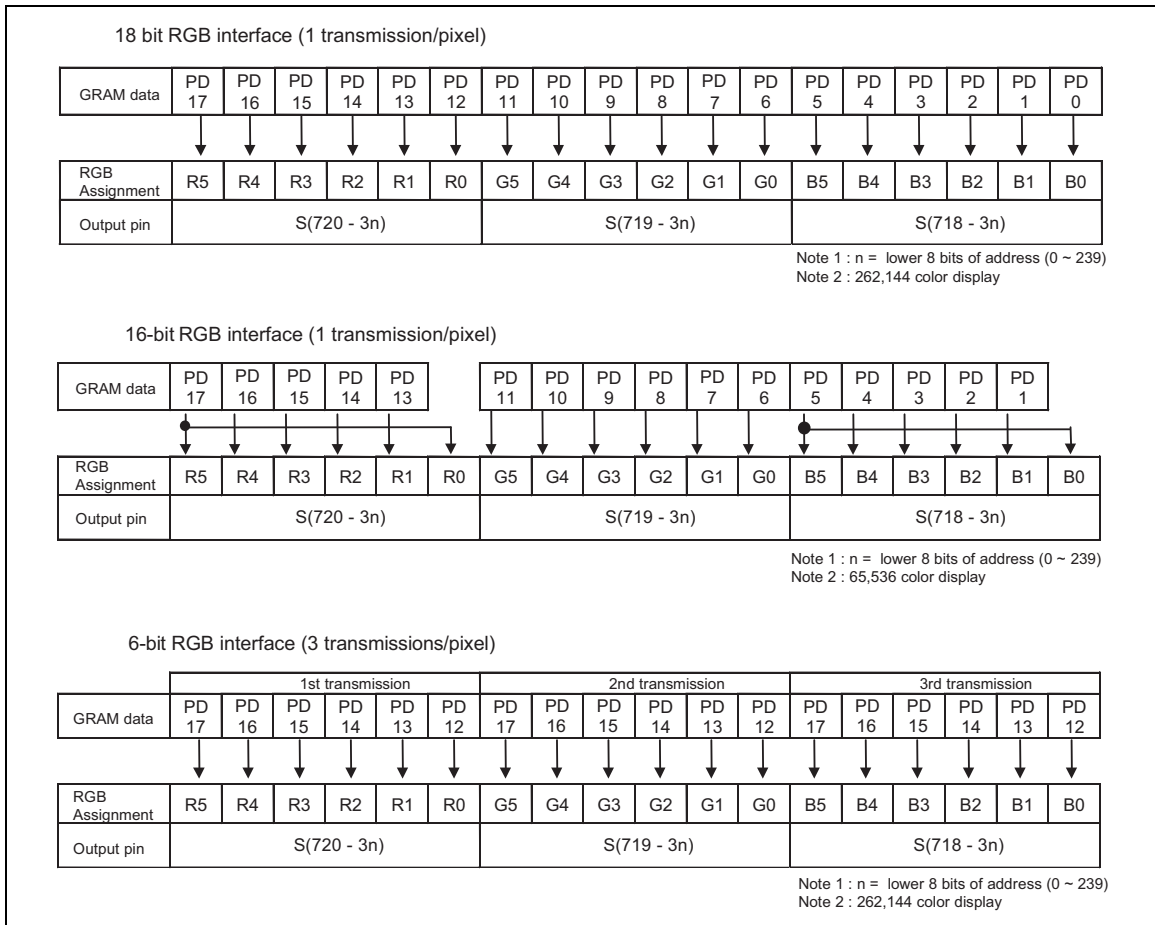

RGB interface (SS = 1, BGR = 1)

Instruction

Outline

The HD66781 adapts an 18-bit bus architecture that enables high-speed interfacing with high-performance microcomputers. The HD66781 starts internal processing of 18/16/9/8-bit data sent from external after storing control information in the instruction register (IR) and data register (DR). Since the internal operation of HD66781 is determined by signals sent from the microcomputer, register selection signal (RS), read/write signal (R/W), and internal 16-bit data bus signals (DB15 to DB0) are called instructions. GRAM is accessed through internal 18-bit data bus. The HD66781 has ten categories of instruction.

1. Specify index
2. Read status
3. Control display
4. Power management control
5. Graphics data processing
6. Set internal GRAM address
7. Transfer data to and from internal GRAM
8. Make an internal γ -adjustment
9. Control a panel
10. Control OSD display

Normally, the instruction to write data on GRAM is used the most often. The address of internal GRAM is updated automatically after data are written to the internal GRAM. With window address function, this reduces the amount of data transmission to minimum and thereby lightens the load on the program processed by the microcomputer. Since instructions are executed in 0 cycle, it is possible to write instructions consecutively.

Instruction data format

As the following figure shows, the assignment to the 16 instruction bits (IB15-0) varies according to the interface in use. An instruction must adopt the data format for each interface.

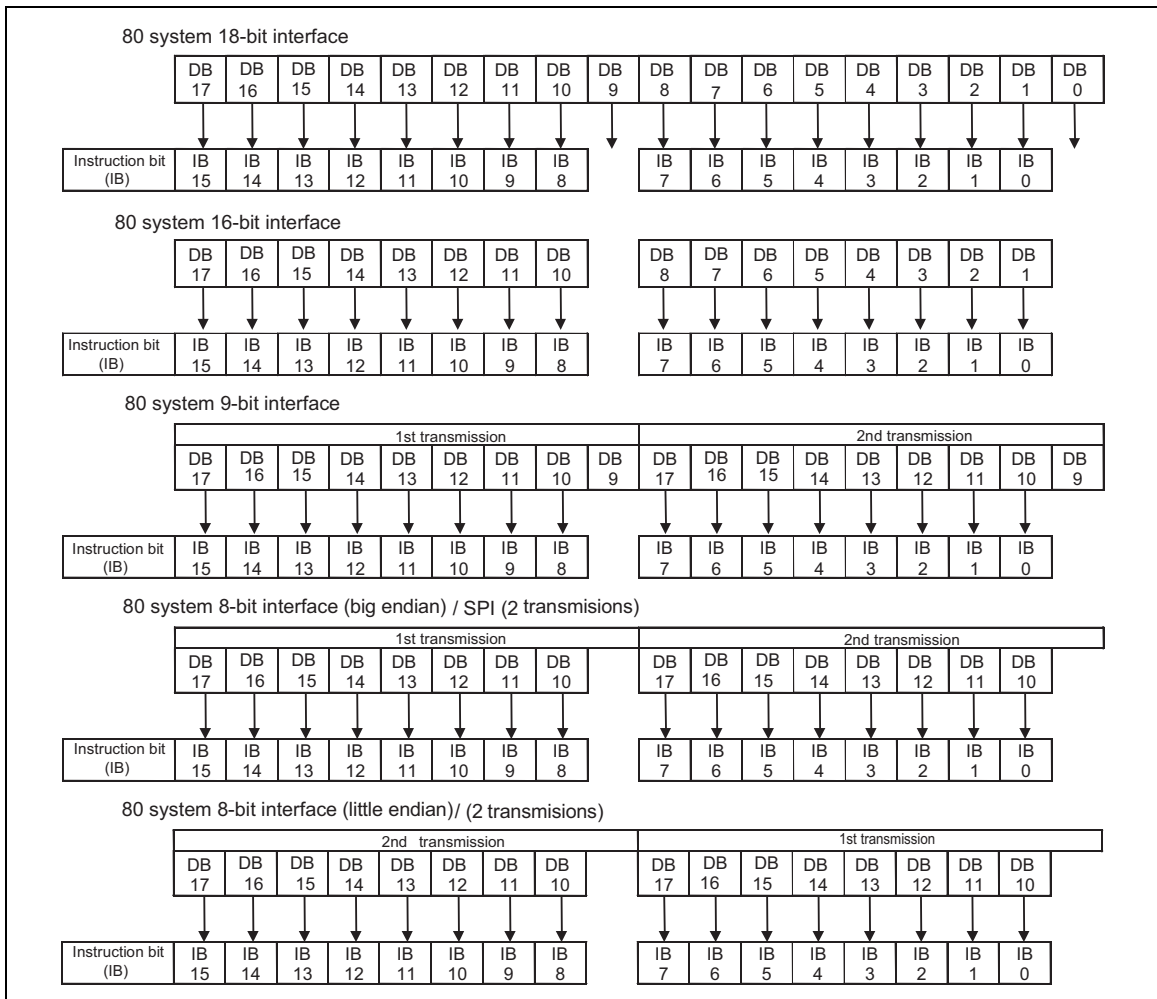

80-system interface instruction data format

Basic Operation modes

The basic operation modes of HD66781 and transitions between the modes are illustrated as follows. A transition between the modes must be made according to the instruction setting flow.

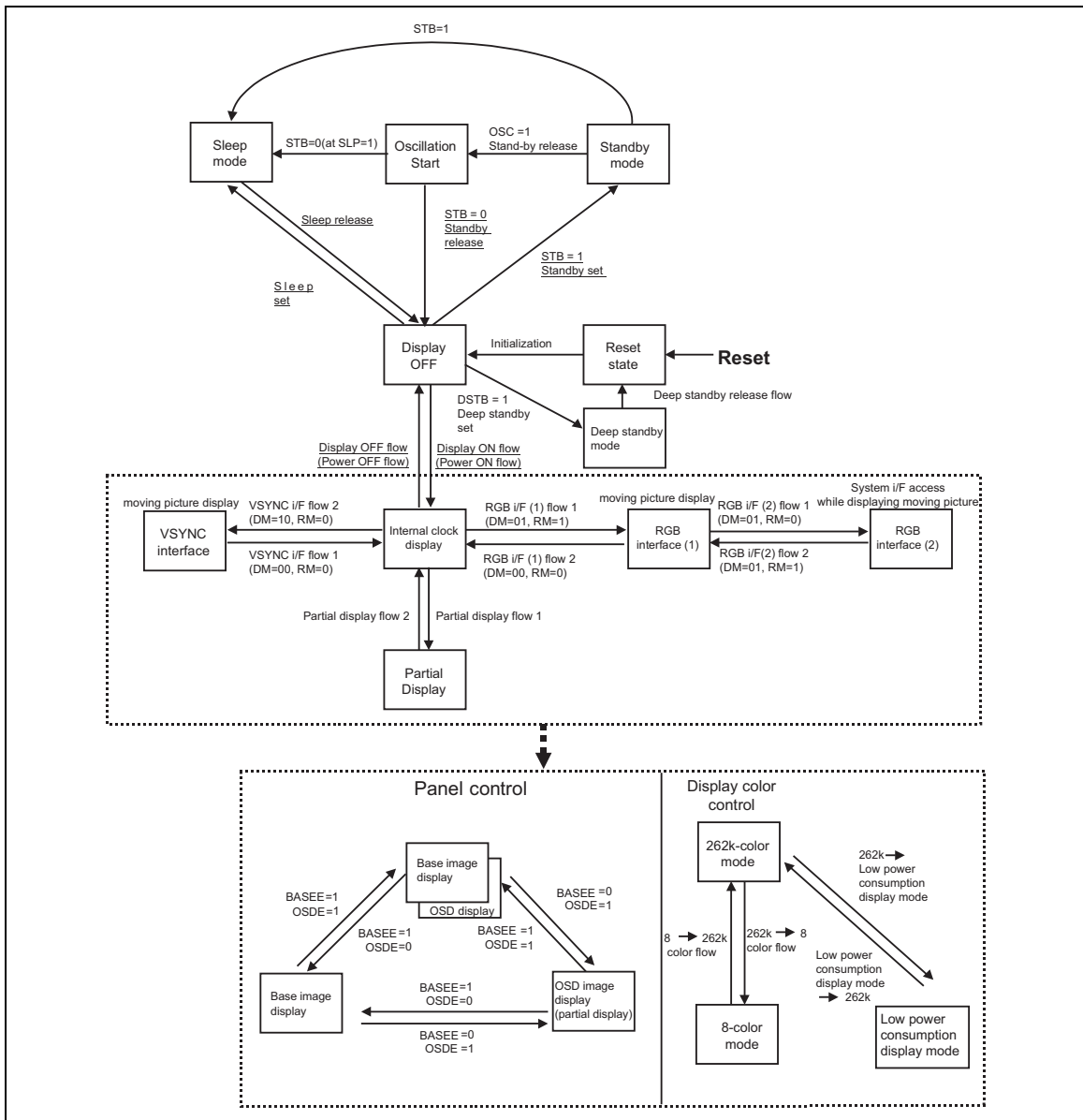

Basic operation modes

Instructions

The following are detail explanations of instructions with illustrations of instruction bits (IB15-0) assigned to each interface.

Index/Status/Display control instruction

Index (IR)

R/W	RS	IB15	IB14	IB13	IB12	IB11	IB10	IB9	IB8	IB7	IB6	IB5	IB4	IB3	IB2	IB1	IB0
W	0	*	*	*	*	*	ID10	ID9	ID8	ID7	ID6	ID5	ID4	ID3	ID2	ID1	ID0

The index instruction specifies the control register and the RAM control indexes that are accessed (R000h to R508h). The register number is set in binary from “000_0000_0000” to “101_0000_1000”. Do not access to the registers and bits to which the index and the instruction bit are not assigned.

Status read (SR)

R/W	RS	IB15	IB14	IB13	IB12	IB11	IB10	IB9	IB8	IB7	IB6	IB5	IB4	IB3	IB2	IB1	IB0
R	0	0	0	0	0	0	0	0	L8	L7	L6	L5	L4	L3	L2	L1	L0

SR read the internal status of HD66781.

L[8:0]: Indicate the position of the raster-row driving liquid crystal.

Start Oscillation (R000h)

R/W	RS	IB15	IB14	IB13	IB12	IB11	IB10	IB9	IB8	IB7	IB6	IB5	IB4	IB3	IB2	IB1	IB0
W	1	*	*	*	*	*	*	*	*	*	*	*	*	*	*	*	1
R	1	0	0	0	0	0	1	1	1	1	0	0	0	0	1	0	0

The start oscillation instruction restarts the oscillator in a halt state during the standby mode. After executing this instruction, wait at least 10ms for stabilizing oscillation before issuing a next instruction. For details, see “ Standby/Sleep mode” (p190.). The device code “0781”H is read out when this register is forced to read out.

Driver Output Control (R001h)

R/W	RS	IB15	IB14	IB13	IB12	IB11	IB10	IB9	IB8	IB7	IB6	IB5	IB4	IB3	IB2	IB1	IB0
W	1	0	0	0	LTPS	0	0	0	SS	0	0	0	0	0	0	0	0

LTPS: Select the type of a panel. The output waveforms from SFTCLK1, 2 vary according to the setting of the panel. When LTPS = 0, a-Si TFT panel waveforms are output. When LTPS = 1, low temperature poly-Si TFT panel waveforms are output. See SFTCLK waveforms (p.67) for detail.

Make a setting for this register when D[1:0] = 2'h0.

SS: Select the correspondence between RAM write address and source driver output.

SS = "0": data written in H'00000 is output from S1.

SS = "1": data written in H'00000 is output from S720.

For details, see "GRAM Address Map".

By making settings for both SS and RGB bits, the assignment of RGB dots to the S1 ~ S720 pins is determined.

When SS = 0 and BGR = 0, R, G, B are assigned interchangeably in this order from S1 to S720.

When SS = 1 and BGR = 1, R, G, B are assigned interchangeably in this order from S720 to S1.

Changes in the SS and BGR settings require RAM data rewrite.

LCD Driving Wave Control (R002h)

R/W	RS	IB15	IB14	IB13	IB12	IB11	IB10	IB9	IB8	IB7	IB6	IB5	IB4	IB3	IB2	IB1	IB0
W	1	0	0	0	0	FLD1	FLD0	B/C	EOR	0	0	NW5	NW4	NW3	NW2	NW1	NW0

NW[5:0]: Specify "n", the number of raster-rows from 1 to 64, to alternate every n+1 raster-rows when C-pattern waveform is generated (B/C = 1).

EOR: When EOR = 1, alternations occur by applying EOR (exclusive OR) operation to an odd/even frame select signal and an n-raster-row inversion signal while a C-pattern waveform is generated (B/C=1). This instruction is used when liquid crystal alternate drive is not available due to a combination of numbers of LCD raster-rows and the value of "n". For details, see "n-raster-row inversion Alternate drive"(p.174).

B/C: When B/C = 0, field alternating waveforms are generated. Alternation occurs every frame to drive liquid crystal. When B/C=1, alternation occurs every n raster-rows. For details, see the "n-raster-row Inversion alternating Drive" section.

FLD[1:0]: Specify the number of fields for n-field interlaced drive. For details, see the “Interlaced Drive”(p.175) section.

Table 5

FLD [1:0]	Numbers of fields
2'h0	Setting disabled
2'h1	1 field (= 1 frame)
2'h2	Setting disabled
2'h3	3 fields

Note 1) This instruction is not available with the external display interface. In the external display interface mode, make sure FLD[1:0] = 2'h1.

The following functions are not available during interlaced drive (FLD =2'h3).

Table 6

Unavailable functions when FLD = 2'h3
External display interface
OSD function (α blending)
Scroll function
Resizing function (vertical direction magnification)

Entry Mode 1 (R003h)

R/W	RS	IB15	IB14	IB13	IB12	IB11	IB10	IB9	IB8	IB7	IB6	IB5	IB4	IB3	IB2	IB1	IB0
W	1	TRI	DFM	0	BGR	0	0	HWM	0	0	0	I/D1	I/D0	AM	0	OSD	ODF

This instruction is for writing data from the microcomputer to the internal GRAM of HD66781.

ODF: Set the format to write OSD data to the internal RAM. When ODF =0, assign transmission rate bits (α channel) to the LSB of RGB data. When ODF = 1, assign transmission rate bit (α channel) to the MSB. OSD bit must be “1” when writing OSD data.

Table 7 BGR = 0

OSD	ODF	D17	D16	D15	D14	D13	D12	D11	D10	D9	D8	D7	D6	D5	D4	D3	D2	D1	D0
0	*	R5	R4	R3	R2	R1	R0	G5	G4	G3	G2	G1	G0	B5	B4	B3	B2	B1	B0
1	0	R5	R4	R3	R2	R1	$\alpha 2$	G5	G4	G3	G2	G1	$\alpha 1$	B5	B4	B3	B2	B1	$\alpha 0$
1	1	$\alpha 2$	$\alpha 1$	$\alpha 0$	R4	R3	R2	R1	R0	G4	G3	G2	G1	G0	B4	B3	B2	B1	B0

Table 8 BGR =1

OSD	ODF	D17	D16	D15	D14	D13	D12	D11	D10	D9	D8	D7	D6	D5	D4	D3	D2	D1	D0
0	*	B5	B4	B3	B2	B1	B0	G5	G4	G3	G2	G1	G0	R5	R4	R3	R2	R1	R0
1	0	B5	B4	B3	B2	B1	$\alpha 0$	G5	G4	G3	G2	G1	$\alpha 1$	R5	R4	R3	R2	R1	$\alpha 2$
1	1	$\alpha 0$	$\alpha 1$	$\alpha 2$	B4	B3	B2	B1	B0	G4	G3	G2	G1	G0	R4	R3	R2	R1	R0

Table 9

$\alpha 2$	$\alpha 1$	$\alpha 0$	Transmission rate	Display screen
0	0	0	0%	Base picture display
0	0	1	-	Setting disabled
0	1	0	25%	Base picture (75%) + OSD image (25%) display
0	1	1	75%	Base picture (25%) + OSD image (75%) display
1	0	0	50%	Base picture (50%) + OSD image (50%) display
1	0	1	-	Setting disabled
1	1	0	100%	OSD image display
1	1	1	-	Setting disabled

OSD: Set RAM write data as OSD data. Set OSD =1, when writing OSD data. By setting OSD to 1, OSD data are written to the internal RAM according to the format set by ODF.

OSD =0: Write normal picture data (18-bit RGB) to RAM

OSD =1: Write OSD image data (18-bit (α +RGB)) to RAM

AM: Set the automatic updating method of address counter after data are written to GRAM.

AM =0, the address counter is updated in horizontal direction.

AM =1, the address counter is updated in vertical direction.

When a window-address range is specified, data are written in the window-address range specified within the GRAM in accordance with I/D1-0 and AM setting.

I/D[1:0]: I/D sets automatic increment (+1) and automatic decrement (-1) of address counter (AC) after data are written to GRAM. When I/D=0, the address counter is incremented or decremented in horizontal direction (lower address: AD7-0). When I/D =1, the address counter is incremented or decremented in vertical direction (upper address: AD16-8). The AM bit specifies the address transition direction when data are being written to GRAM.

HWM: When HWM =1, data are written to GRAM in high speed with low power consumption. In power saving high-speed write mode, the data in the horizontal line of rectangular area specified by the window address are stored in the line buffer and one-line data are written to GRAM at once. This minimizes the number of RAM access required to write data and thereby reduces power consumption.

When HWM =1, the data write in horizontal direction must be executed by line of the specified window-address range. If data write is terminated in the middle of the line, data in that line are not correctly written to GRAM.

Note 1) Insertion of dummy write is not required in high-speed write mode.

Note 2) Data in the buffer will be erased if RAM write is terminated in the middle of a line and other instruction set is executed.

Note 3) In the high-speed write mode, wait at least 2 write cycles (t_{cyw}) of the normal write mode after RAM write before making a transition from RAM write to index write.

BGR: Change the order of (R), (G), (B) dots to (B), (G), (R) when the dots are assigned to the 18-bit write data.

BGR=0, the dot order (R), (G), (B) is not changed when 18-bit data are written to GRAM.

BGR =1, the dot order changes from (R), (G), (B) to (B), (G), (R) when 18-bit data are written to GRAM. The assignment of α bit of OSD data is also changed.

DFM: Set the data format for 3-RAM-write 18-bit data transfers in 80-system 8-bit interface (big-endian) mode when IM3-0 = GND/GND/ Vcc1/Vcc1 in conjunction with TRI.

DFM =0, RGB 18-bit data are written to GRAM by byte-boundary 3 transfers.

DFM =1, RGB 18-bit data are written to GRAM by 3 x 6-bit transfer.

Set the data format for 2-RAM-write 18-bit data transfers in 80-system 16-bit interface mode when IM3-0 = GND/GND/Vcc1/GND in conjunction with TRI.

DFM =0, RGB 18-bit data are written to GRAM in the MSB format by 2 transfers.

DFM =1, RGB 18-bit data are written to GRAM in the LSB format by 2 transfers.

DFM must be set to 0, when not using 8- or 16-bit interface.

TRI: Make the 3-RAM-write transfers available in 80-system 8-bit interface (big-endian) when IM3-0 = GND/GND/Vcc1/Vcc1.

TRI =0, 16-bit RAM data are transferred in 2 transfers.

TRI =1, 18-bit RAM data are transferred in 3 transfers.

Make the 2-RAM-write transfers available in 80-system 16-bit interface (big-endian) when IM3-0 = GND/GND/Vcc1/GND.

TRI =0, 16-bit RAM data are transferred in one transfer.

TRI =1, 18-bit RAM data are transferred in 2 transfers.

TRI must be set to 0, when not using 8- or 16-bit interface. During RAM read, set TRI = 0.

TRI	DFM	8-bit interface RAM write transmission formula																																																		
0	*	<p>IM3-0 = (GND, GND, Vcc1, Vcc1)</p> <p>80 system 8-bit interface(big endian) (2 transmissions/pixel) 65,536 colors</p> <p>GRAM data</p> <table border="1"> <tr> <td colspan="8">1st transmission</td> <td colspan="8">2nd transmission</td> </tr> <tr> <td>DB 17</td><td>DB 16</td><td>DB 15</td><td>DB 14</td><td>DB 13</td><td>DB 12</td><td>DB 11</td><td>DB 10</td> <td>DB 17</td><td>DB 16</td><td>DB 15</td><td>DB 14</td><td>DB 13</td><td>DB 12</td><td>DB 11</td><td>DB 10</td> </tr> </table> <p>RGB Assignment</p> <table border="1"> <tr> <td>R5</td><td>R4</td><td>R3</td><td>R2</td><td>R1</td><td>R0</td><td>G5</td><td>G4</td><td>G3</td><td>G2</td><td>G1</td><td>G0</td><td>B5</td><td>B4</td><td>B3</td><td>B2</td><td>B1</td><td>B0</td> </tr> </table>	1st transmission								2nd transmission								DB 17	DB 16	DB 15	DB 14	DB 13	DB 12	DB 11	DB 10	DB 17	DB 16	DB 15	DB 14	DB 13	DB 12	DB 11	DB 10	R5	R4	R3	R2	R1	R0	G5	G4	G3	G2	G1	G0	B5	B4	B3	B2	B1	B0
1st transmission								2nd transmission																																												
DB 17	DB 16	DB 15	DB 14	DB 13	DB 12	DB 11	DB 10	DB 17	DB 16	DB 15	DB 14	DB 13	DB 12	DB 11	DB 10																																					
R5	R4	R3	R2	R1	R0	G5	G4	G3	G2	G1	G0	B5	B4	B3	B2	B1	B0																																			
0	*	<p>IM3-0 = (GND, Vcc1, Vcc1, Vcc1)</p> <p>80 system 8-bit interface (little endian) (2 transmissions/pixel) 65,536 colors</p> <p>GRAM data</p> <table border="1"> <tr> <td colspan="8">2nd transmission</td> <td colspan="8">1st transmission</td> </tr> <tr> <td>DB 17</td><td>DB 16</td><td>DB 15</td><td>DB 14</td><td>DB 13</td><td>DB 12</td><td>DB 11</td><td>DB 10</td> <td>DB 17</td><td>DB 16</td><td>DB 15</td><td>DB 14</td><td>DB 13</td><td>DB 12</td><td>DB 11</td><td>DB 10</td> </tr> </table> <p>RGB Assignment</p> <table border="1"> <tr> <td>R5</td><td>R4</td><td>R3</td><td>R2</td><td>R1</td><td>R0</td><td>G5</td><td>G4</td><td>G3</td><td>G2</td><td>G1</td><td>G0</td><td>B5</td><td>B4</td><td>B3</td><td>B2</td><td>B1</td><td>B0</td> </tr> </table>	2nd transmission								1st transmission								DB 17	DB 16	DB 15	DB 14	DB 13	DB 12	DB 11	DB 10	DB 17	DB 16	DB 15	DB 14	DB 13	DB 12	DB 11	DB 10	R5	R4	R3	R2	R1	R0	G5	G4	G3	G2	G1	G0	B5	B4	B3	B2	B1	B0
2nd transmission								1st transmission																																												
DB 17	DB 16	DB 15	DB 14	DB 13	DB 12	DB 11	DB 10	DB 17	DB 16	DB 15	DB 14	DB 13	DB 12	DB 11	DB 10																																					
R5	R4	R3	R2	R1	R0	G5	G4	G3	G2	G1	G0	B5	B4	B3	B2	B1	B0																																			
1	0	<p>IM3-0 = (GND, GND, Vcc1, Vcc1)</p> <p>80 system 8-bit interface (3 transmissions/pixel) 262,144 colors</p> <p>GRAM data</p> <table border="1"> <tr> <td colspan="4">1st transmission</td> <td colspan="4">2nd transmission</td> <td colspan="4">3rd transmission</td> </tr> <tr> <td>DB 17</td><td>DB 16</td><td>DB 15</td><td>DB 14</td><td>DB 13</td><td>DB 12</td><td>DB 11</td><td>DB 10</td> <td>DB 17</td><td>DB 16</td><td>DB 15</td><td>DB 14</td><td>DB 13</td><td>DB 12</td><td>DB 11</td><td>DB 10</td> </tr> </table> <p>RGB Assignment</p> <table border="1"> <tr> <td>R5</td><td>R4</td><td>R3</td><td>R2</td><td>R1</td><td>R0</td><td>G5</td><td>G4</td><td>G3</td><td>G2</td><td>G1</td><td>G0</td><td>B5</td><td>B4</td><td>B3</td><td>B2</td><td>B1</td><td>B0</td> </tr> </table>	1st transmission				2nd transmission				3rd transmission				DB 17	DB 16	DB 15	DB 14	DB 13	DB 12	DB 11	DB 10	DB 17	DB 16	DB 15	DB 14	DB 13	DB 12	DB 11	DB 10	R5	R4	R3	R2	R1	R0	G5	G4	G3	G2	G1	G0	B5	B4	B3	B2	B1	B0				
1st transmission				2nd transmission				3rd transmission																																												
DB 17	DB 16	DB 15	DB 14	DB 13	DB 12	DB 11	DB 10	DB 17	DB 16	DB 15	DB 14	DB 13	DB 12	DB 11	DB 10																																					
R5	R4	R3	R2	R1	R0	G5	G4	G3	G2	G1	G0	B5	B4	B3	B2	B1	B0																																			
1	1	<p>IM3-0 = (GND, GND, Vcc1, Vcc1)</p> <p>80 system 8-bit interface (3 transmissions/pixel) 262,144 colors</p> <p>GRAM data</p> <table border="1"> <tr> <td colspan="4">1st transmission</td> <td colspan="4">2nd transmission</td> <td colspan="4">3rd transmission</td> </tr> <tr> <td>DB 17</td><td>DB 16</td><td>DB 15</td><td>DB 14</td><td>DB 13</td><td>DB 12</td><td>DB 11</td><td>DB 10</td> <td>DB 17</td><td>DB 16</td><td>DB 15</td><td>DB 14</td><td>DB 13</td><td>DB 12</td><td>DB 11</td><td>DB 10</td> </tr> </table> <p>RGB Assignment</p> <table border="1"> <tr> <td>R5</td><td>R4</td><td>R3</td><td>R2</td><td>R1</td><td>R0</td><td>G5</td><td>G4</td><td>G3</td><td>G2</td><td>G1</td><td>G0</td><td>B5</td><td>B4</td><td>B3</td><td>B2</td><td>B1</td><td>B0</td> </tr> </table>	1st transmission				2nd transmission				3rd transmission				DB 17	DB 16	DB 15	DB 14	DB 13	DB 12	DB 11	DB 10	DB 17	DB 16	DB 15	DB 14	DB 13	DB 12	DB 11	DB 10	R5	R4	R3	R2	R1	R0	G5	G4	G3	G2	G1	G0	B5	B4	B3	B2	B1	B0				
1st transmission				2nd transmission				3rd transmission																																												
DB 17	DB 16	DB 15	DB 14	DB 13	DB 12	DB 11	DB 10	DB 17	DB 16	DB 15	DB 14	DB 13	DB 12	DB 11	DB 10																																					
R5	R4	R3	R2	R1	R0	G5	G4	G3	G2	G1	G0	B5	B4	B3	B2	B1	B0																																			

8-bit interface: RAM write transmission

Note 1) Instruction setting is transferred by 2 x 8-bit transmissions regardless of TRI and DFM settings.

TRI	DFM	16-bit interface RAM write transmission formula
0	*	<p>80 system 16-bit interface (1 transmission/pixel) 65,536 colors</p>
1	0	<p>80 system 16-bit interface (2 transmissions/pixel) 262,144 colors</p>
1	1	<p>80 system 16-bit interface (2 transmissions/pixel) 262,144 colors</p>

16-bit interface: RAM write transmission

Note 1) Instruction setting is transferred by 1 x 16-bit transmission regardless of TRI and DFM settings.

Direction Setting	I/D1-0 = "00" Horizontal: Decrement Vertical: Decrement	I/D1-0 = "01" Horizontal: Increment Vertical: Decrement	I/D1-0 = "10" Horizontal: Decrement Vertical: Increment	I/D1-0 = "11" Horizontal: Increment Vertical: Increment
AM = "0" Horizontal				
AM = "1" Vertical				

Address direction setting

Note 1) When a window-address range is specified, write operation is executed only within the specified window-address range of GRAM.

Resizing Control 1/2 (R004/R005h)

R/W	RS	IB15	IB14	IB13	IB12	IB11	IB10	IB9	IB8	IB7	IB6	IB5	IB4	IB3	IB2	IB1	IB0
W	1	0	0	0	0	0	0	RCV ₁	RCV ₀	0	0	RCH1	RCH0	0	0	RSR1	RSR0
W	1	RSE _{V7}	RSE _{V6}	RSE _{V5}	RSE _{V4}	RSE _{V3}	RSE _{V2}	RSE _{V1}	RSE _{V0}	0	0	0	0	0	0	0	RSEH

RSR[1:0]: Set the contraction scale which is applied during RAM write. When the resizing scale is set, data are written to RAM according to this bit scale in horizontal and vertical directions. See the “Resizing Function” (p.105) section for details.

RCH[1:0]: RCH specifies the number of surplus pixels in the horizontal direction, which are made after resizing a picture. By specifying the number of surplus pixels, it is possible to disregard the surplus pixels when data are transferred. This instruction is only available with resizing function. Set RCH = 2'h0 when resizing function is not used (RSR = 2'h0).

RCV[1:0]: RCV specifies the number of surplus pixels in the vertical direction, which are made after resizing a picture. By specifying the number of surplus pixels, it is possible to disregard the surplus pixels when data are transferred. This instruction is only available with resizing function. Set RCV = 2'h0 when resizing function is not used (RSR = 2'h0).

RSEH: Set the magnifying scale in the horizontal direction of a picture. When the magnifying scale is set, data are written to RAM according to the bit scale in horizontal direction. See “Resizing Function” for details.

RSEV[7:0]: Set magnifying scale in the vertical direction of a picture. When the magnifying scale is set, the data in the internal RAM are magnified when displayed.

Note 1) When using picture magnification function, the picture resizing scale register (contraction) must be RSR1-0 = 2'h0.

Note 2) When using picture contraction function, the picture resizing scale (magnification) must be set RSEV7-0 = 8'h00, RSEH = 0.

Note 3) Base picture scrolling function and vertical-direction display magnification function cannot be used simultaneously.

Settings for resizing scales**Table 10 Resizing scale ratio setting (RSR)**

RSR[1:0]	Resizing scale
2'h0	No resizing (x 1)
2'h1	x 1/2
2'h2	Setting disabled
2'h3	x 1/4

Table 11 Setting for the number of surplus pixel in the horizontal/vertical direction (RCV, RCH)

RCH [1:0] / RCV [1:0]	Number of pixel surplus in horizontal/vertical direction
2'h0	0 pixel
2'h1	1 pixel
2'h2	2 pixels
2'h3	3 pixels

Note 1) 1 pixel = 1RGB

Table 12 magnification in horizontal direction (RSEH)

RSEH	Magnification
2'h0	No resizing (x1)
2'h1	2 times (x2)

Table 13 BASE picture magnification in the vertical direction (RSEV)

RSEV [1:0]	Magnification
2'h0	No resizing (x1)
2'h1	2 times (x2)
2'h2	Setting disabled
2'h3	Setting disabled

Table 14 OSD image 1 magnification in the vertical direction (RSEV)

RSEV [3:2]	Magnification
2'h0	No resizing (x1)
2'h1	2 times (x2)
2'h2	4 times (x4)
2'h3	Setting disabled

Table 15 OSD image 2 magnification in the vertical direction (RSEV)

RSEV [5:4]	Magnification
2'h0	No resizing (x1)
2'h1	2 times (x2)
2'h2	4 times (x4)
2'h3	Setting disabled

Table 16 OSD image 3 magnification in the vertical direction (RSEV)

RSEV [7:6]	Magnification
2'h0	No resizing (x1)
2'h1	2 times (x2)
2'h2	4 times (x4)
2'h3	Setting disabled

Display Control 1 (R007h)

R/W	RS	IB15	IB14	IB13	IB12	IB11	IB10	IB9	IB8	IB7	IB6	IB5	IB4	IB3	IB2	IB1	IB0
W	1	0	OSD E2	OSD E1	OSD E0	0	0	0	BASE E	0	0	0	DTE	0	0	D1	D0

D[1:0]: The graphics display is shown when D[1] = 1, and turned off when D[1] = 0. When setting D[1] = 0, the data are retained in GRAM. This means the graphics display is instantly shown when setting D[1] to 1. When D[1] is 0 (i.e. the display is not shown) all source outputs are set to the GND level. This reduces the charged/discharged current on LCD, which is generated during liquid crystal alternate drive.

When D = 2'b01, the display operation is being executed inside the HD66781 even while the external display is turned off. When D = 2'b00, both internal and external display operations are halted.

In combination with GON and DTE bits, D1-0 bits control ON/OFF of display. For details, see the "Instruction Setting"(p.185) section.

Table 17

D[1:0]	Source output	HD66781 internal operation	Gate control signal/Power supply IC, LCD panel control signal (FLM, CL1/SFTCLK1, 2, DCCLK, EQ)
2'h0	GND	Halt	Halt
2'h1	GND	Continue	Continue
2'h2	Non-lit display	Continue	Continue
2'h3	Display	Continue	Continue

Note 1) Data from the microcomputer can be written to GRAM irrespective of D bit setting.

Note 2) D = 2'h00 during the standby mode. In this case, the register setting of D bit is not changed.

Note 3) A picture displayed when D = 2'b11 is specified by the BASEE setting.

DTE: Control the DISPTMG output.

Table 18

DTE	DISPTMG
0	GND
1	Vcc1/GND

BASEE: Set display enable of a base image. The D-bit setting takes precedence over the BASEE-bit setting.

Table 19

D[1:0]	BASEE	Source Output (S1~S720)
2'h0	*	GND
2'h1	*	GND
2'h2	*	Non-lit level
2'h3	0	Non-lit display
	1	Display BASE image

Note 1) The source output at the "non-lit display" level is determined according to the PTS bit setting.

Note 2) Gate lines are scanned in the manner determined by the PTS bit setting during the non-lit display.

OSDE0: Display enable bit for OSD image 1.

OSDE1: Display enable bit for OSD image 2.

OSDE2: Display enable bit for OSD image 3.

OSDE0/OSDE1/OSDE2 = 0, the HD66781 does not display OSD images. Only base images are displayed.

OSDE0/OSDE1/OSDE2 = 1, the HD66781 displays OSD images according to the α channel bits in the pixel data of the OSD image.

When OSDE =1, while a base image is not displayed (BASEE =0), an OSD is displayed with 100% transmission rate.

Display Control 2 (R008h)

R/W	RS	IB15	IB14	IB13	IB12	IB11	IB10	IB9	IB8	IB7	IB6	IB5	IB4	IB3	IB2	IB1	IB0
W	1	0	0	0	0	FP3	FP2	FP1	FP0	0	0	0	0	BP3	BP2	BP1	BP0

FP [3:0]: Set the number of lines for a front porch (a blank period made before the end of display).

BP [3:0]: Set the number of lines for a back porch (a blank period made after the beginning of display).

In the external display interface mode, a back porch (BP) period starts at the falling edge of VSYNC and display operation starts after the back porch period. A front porch (FP) period starts after the numbers of raster-rows set with NL bit are driven for display. After the front porch period, a blank period continues until the next VSYNC input.

Table 20

FP [3:0] BP [3:0]	Number of Front porch line Number of Back porch line
4'h0	Setting disabled
4'h1	Setting disabled
4'h2	2 lines
4'h3	3 lines
4'h4	4 lines
4'h5	5 lines
4'h6	6 lines
4'h7	7 lines
4'h8	8 lines
4'h9	9 lines
4'hA	10 lines
4'hB	11 lines
4'hC	12 lines
4'hD	13 lines
4'hE	14 lines
4'hF	Setting disabled

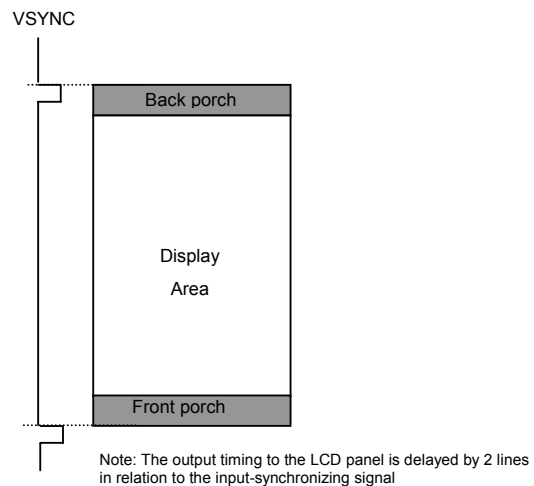

Set BP, FP, and MP within the range indicated below.

Table 21

Internal clock operation	FLD = 2'h1	BP ≥ 2 lines	FP ≥ 2 lines	FP+BP ≤ 16 lines
	FLD = 2'h3	BP = 3 lines	FP = 5 lines	
RGB interface		BP ≥ 2 lines	FP ≥ 2 lines	FP+BP ≤ 16 lines
VSYNC interface		BP ≥ 2 lines	FP ≥ 2 lines	FP+BP = 16 lines

Display Control 3 (R009h)

R/W	RS	IB15	IB14	IB13	IB12	IB11	IB10	IB9	IB8	IB7	IB6	IB5	IB4	IB3	IB2	IB1	IB0
W	1	0	0	0	0	0	PTS2	PTS1	PTS0	0	0	PTG1	PTG0	ISC3	ISC2	ISC1	ISC0

ISC [3:0]: Specify the cycle to scan gate lines, when PTG bits set the scan mode in the non-display area to the interval scan mode. The scan cycle is always odd number of frames, and polarity inversion is applied each timing when gate lines are scanned.

Table 22

ISC [3:0]	Scan cycle	When (fFLM) = 60Hz
4'h0	Setting disabled	-
4'h1	3 frames	50ms
4'h2	5 frames	84ms
4'h3	7 frames	117ms
4'h4	9 frames	150ms
4'h5	11 frames	184ms
4'h6	13 frames	217ms
4'h7	15 frames	251ms
4'h8	17 frames	284ms
4'h9	19 frames	317ms
4'hA	21 frames	351ms
4'hB	23 frames	384ms
4'hC	25 frames	418ms
4'hD	27 frames	451ms
4'hE	29 frames	484ms
4'hF	31 frames	518ms

PTG [1:0]: Set the DISPTMG output to determine the gate bus line scan mode in non-display area. The setting is applied to all no-display areas and front/back porch periods of the entire panel.

Table 23

PTG[1:0]	DISPTMG output	Gate output in non-display area	Source output in non-display area
2'h0	Normal drive	Normal scan	PT setting
2'h1	GND	VGL (fixed)	PT setting
2'h2	Interval drive	Interval scan	PT setting
2'h3	Setting disabled	-	-

Note 1) Set alternating drive to frame cycle when using interval scan.

PTS [2:0]: Determine the kind of source outputs in the no-display area, which is applied to the front/back porch periods and non-display area of partial display. When PTS [2] =1, the grayscale voltage generating amplifiers are halted except those for the V0 and V63 levels during no-display area drive period to reduce power consumption.

Table 24

PTS[2:0]	Non-display source output		Non-display area	Non-display area
	Positive polarity	Negative polarity	Operation of grayscale amplifier	Step up clock frequency
3'h0	V63	V0	V0 to V63	DC0, DC1 setting
3'h1	Setting disabled	Setting disabled	-	DC0, DC1 setting
3'h2	GND	GND	V0 to V63	DC0, DC1 setting
3'h3	Hi-Z	Hi-Z	V0 to V63	DC0, DC1 setting
3'h4	V63	V0	V0, V63	DC0, DC1 setting x 1/2
3'h5	Setting disabled	Setting disabled	-	-
3'h6	GND	GND	V0, V63	DC0, DC1 setting x 1/2
3'h7	Hi-z	Hi-z	V0, V63	DC0, DC1 setting x 1/2

Note 1) Gate outputs in non-display area are controlled by the off-scan mode (PTG).

Note 2) Grayscale amplifier operation halt and slowdown of step-up clocks are applied to the non-display area.

Note 3) When DC[4:3]=2'h3, the frequency of step-up clocks in the non-display area are not slowed down half even if PTS[2:0] is set to 4, 6 or 7.

Display Control 4 (R00Bh)

R/W	RS	IB15	IB14	IB13	IB12	IB11	IB10	IB9	IB8	IB7	IB6	IB5	IB4	IB3	IB2	IB1	IB0
W	1	0	FRC ON	D16 B	0	0	0	0	0	0	0	0	0	0	0	COL 1	COL 0

FRCON: Make a setting for the FRC mode. Control on and off of the FRC mode.

D16B: When FRCON=1, the FRC mode sets in. When COL[1:0]=2'h1 and the low-power display mode, where only 32 operational amplifiers are used, the FRC mode enables display with abundant colors. For details, see “low-power display mode”(p.169).

Set D16B to 1 when using a 16-bit interface (one-transfer 16-bit interface, 2-transfer 8-bit interface, 16-bit SPI, RGB interfaces).

Table 25

Interface mode	FRCON	D16B	Colors
18-bit, 16-bit x2, 9-bit x2, 8-bit x3, RGB 18-bit, 6-bit x3	0	*	262,144
	1	0	250,047
16-bit x1, 8-bit x2, SPI	0	*	65,536
	1	1	64,512

Note 1) When the FRC mode is on, do not switch the interface mode settings (M, TRI, D16B registers)

Note 2) When the FRC mode is on, 18-bit format data and 16-bit format data are not displayed simultaneously.

COL[1:0]: When COL=2'h1, 32 grayscale operational amplifiers are halted. When making a setting, it must follow the setting sequence in the “Low Power Consumption Display Mode” section.

When COL = 2'h2, 8-color mode sets in. When making a setting, it must follow the setting sequence in the “8-Color Display Mode” section. All operational amplifiers except V0 and V63 levels are halted for low power consumption display.

Table 26

COL[1:0]	Amplifiers in operation	Available colors for display	
		FRCON = 0	FRCON = 1
2'h0	64	262,144 colors/65,536 colors	-
2'h1	32	32,768 colors	250,047 colors/64,512 colors
2'h2	2	8 colors	-
2'h3	Setting disabled	Setting disabled	Setting disabled

Note 1) When COL[1:0] =2'h1 and FRCON = 0, do not write data that correspond to the grayscale levels the amplifiers of which are halted.

Table 27 grayscale level amplifiers in operation (when REV=0)

amplifier	COL[1:0]			GRAM data	
	2'h0	2'h1	2'h2	RGB	RGB
V0	*	*	*	6'h00	6'h3F
V1	*			6'h01	6'h3E
V2	*	*		6'h02	6'h3D
V3	*			6'h03	6'h3C
V4	*	*		6'h04	6'h3B
V5	*			6'h05	6'h3A
V6	*	*		6'h06	6'h39
V7	*			6'h07	6'h38
V8	*	*		6'h08	6'h37
V9	*			6'h09	6'h36
V10	*	*		6'h0A	6'h35
V11	*			6'h0B	6'h34
V12	*	*		6'h0C	6'h33
V13	*			6'h0D	6'h32
V14	*	*		6'h0E	6'h31
V15	*			6'h0F	6'h30
V16	*	*		6'h10	6'h2F
V17	*			6'h11	6'h2E
V18	*	*		6'h12	6'h2D
V19	*			6'h13	6'h2C
V20	*	*		6'h14	6'h2B
V21	*			6'h15	6'h2A
V22	*	*		6'h16	6'h29
V23	*			6'h17	6'h28
V24	*	*		6'h18	6'h27
V25	*			6'h19	6'h26
V26	*	*		6'h1A	6'h25
V27	*			6'h1B	6'h24
V28	*	*		6'h1C	6'h23
V29	*			6'h1D	6'h22
V30	*	*		6'h1E	6'h21
V31	*			6'h1F	6'h20

*: amplifier in operation

amplifier	COL[1:0]			GRAM data	
	2'h0	2'h1	2'h2	RGB	RGB
V32	*			6'h20	6'h1F
V33	*	*		6'h21	6'h1E
V34	*			6'h22	6'h1D
V35	*	*		6'h23	6'h1C
V36	*			6'h24	6'h1B
V37	*	*		6'h25	6'h1A
V38	*			6'h26	6'h19
V39	*	*		6'h27	6'h18
V40	*			6'h28	6'h17
V41	*	*		6'h29	6'h16
V42	*			6'h2A	6'h15
V43	*	*		6'h2B	6'h14
V44	*			6'h2C	6'h13
V45	*	*		6'h2D	6'h12
V46	*			6'h2E	6'h11
V47	*	*		6'h2F	6'h10
V48	*			6'h30	6'h0F
V49	*	*		6'h31	6'h0E
V50	*			6'h32	6'h0D
V51	*	*		6'h33	6'h0C
V52	*			6'h34	6'h0B
V53	*	*		6'h35	6'h0A
V54	*			6'h36	6'h09
V55	*	*		6'h37	6'h08
V56	*			6'h38	6'h07
V57	*	*		6'h39	6'h06
V58	*			6'h3A	6'h05
V59	*	*		6'h3B	6'h04
V60	*			6'h3C	6'h03
V61	*	*		6'h3D	6'h02
V62	*			6'h3E	6'h01
V63	*	*	*	6'h3F	6'h00

External Display interface Control 1 (R00Ch)

R/W	RS	IB15	IB14	IB13	IB12	IB11	IB10	IB9	IB8	IB7	IB6	IB5	IB4	IB3	IB2	IB1	IB0
W	1	0	0	0	0	0	0	0	RM	0	0	DM [1]	DM [0]	0	0	RIM [1]	RIM [0]

RIM[1:0] Make settings for the RGB interface mode when the RGB interface is selected with DM and RM bits. The setting must be made before the display through an external display interface. Do not make changes to the setting during display.

Table 28

RIM[1:0]	RGB interface mode	Colors
2'h0	18-bit RGB interface (1 transmission/pixel)	262,144
2'h1	16-bit RGB interface (1 transmission/pixel)	65,536
2'h2	6-bit RGB interface (3 transmission/pixel)	262,144
2'h3	Setting disabled	-

Note 1) The instruction register setting is made only through a system interface.

Note 2) Data transfer and DOTCLK input must be by the RGB unit when a 6-bit RGB interface is selected.

DM[1:0]: Set a display operation mode. An interface for display operation is selected by the DM setting. DM allows switching between the internal clock operation mode and the external display interface mode. Do not try to switch between the external interface modes (RGB-I/F and VSYNC-I/F).

Table 29

DM[1:0]	Display operation interface
2'h0	Internal clock operation
2'h1	RGB interface
2'h2	VSYNC interface
2'h3	Setting disabled-

RM: Set a RAM access interface. RAM access is made only through the interface specified by the RM setting. Set RM to 1 when writing display data through the RGB interface. This setting is valid irrespective of the display operation mode. Changes in display data can be made by setting RM to 0, which enables RAM data overwrite through a system interface, even while the screens are displayed through the RGB interface mode.

Table 30

RM	Display operation interface
0	Internal clock operation/VSYNC interface
1	RGB interface

As the following table shows, an optimum interface is selected for the kind of display by the external display interface control setting.

Write display data during moving picture display (through RGB and VSYNC interfaces) in the high-speed write mode (HWM=1), which enables high-speed RAM access with low power consumption.

Table 31

Kind of Display	Operation mode	RAM access setting (RM)	Display operation mode (DM)
still picture	internal clock operation only	system interface (RM = 0)	internal clock operation (DM = 2'h0)
moving picture	RGB interface (1)	RGB interface (RM = 1)	RGB interface (DM = 2'h1)
Write over still picture area during moving picture display	RGB interface (2)	system interface (RM = 0)	RGB interface (DM = 2'h1)
moving picture	VSYNC interface	system interface (RM = 0)	VSYNC interface (DM = 2'h2)

Note 1) The instruction register settings are made only through a system interface.

Note 2) No switching between the RGB and VSYNC interfaces is made.

Note 3) No change in the settings of RGB interface mode (RIM) is made during the RGB interface operation.

Note 4) See "External Display Interface" for reference to the transition flows between the modes.

Note 5) Use the RGB and VSYNC interfaces in the high-speed write mode (HWM =1).

Internal clock mode: All display operations are controlled by signals generated by the internal clock in internal clock operation mode. All inputs through the external display interface are invalid. The internal RAM is accessible only through a system interface.

RGB interface mode (1): Display operation is controlled by the frame synchronizing clock (VSYNC), line synchronizing signal (VSYNC), and dot clock (DOTCLK) in the RGB interface mode. These signals must be supplied throughout the display operation in this mode.

All display data are stored in the internal RAM, transmitted through DB17-0 bits by pixel. The combination with the window address function enables simultaneous display of both moving picture areas and the internal RAM area. The data are transmitted only when the screen is being updated, thereby reducing the overall data transmission to minimum.

The periods of the front (FP) and back (BP) porches and the display period (NL) are automatically generated in the HD66782 by counting the clock of line synchronizing signal (HSYNC) in accordance to the frame synchronizing signal (VSYNC). Transmit pixel data through DB17-0 bits in accordance with the aforementioned setting.

RGB interface mode (2): When RGB-I/F is selected, RAM data are changeable through the system interface. This write operation must be performed while display data are not being transmitted through the RGB-I/F (ENABLE = High). When reverting from the system interface mode to the data transmission through the RGB interface, make a new setting for the address set and index (R202h) after changing the aforementioned settings.

VSYNC interface mode: The internal display operation is synchronized with the frame-synchronizing signal (VSYNC) in the VSYNC interface mode. By writing data to RAM at a fixed speed on the falling edge of VSYNC, it enables moving pictures display with a system interface. In this case, there are some constraints in the RAM write speed and methods. For details, see “External Display Interface” (p.139).

In the VSYNC-I/F mode, only VSYNC input is valid. Other input signals for the external display interface are invalid.

The front porch (FP), back porch (BP) periods and display period (NL) are automatically generated in accordance to the frame synchronizing signal (VSYNC) according to the register setting of HD66781.

Frame Cycle Control (R00Dh)

R/W	RS	IB15	IB14	IB13	IB12	IB11	IB10	IB9	IB8	IB7	IB6	IB5	IB4	IB3	IB2	IB1	IB0
W	1	0	0	0	0	0	0	DIVI1	DIVI0	0	0	0	RTNI 4	RTNI 3	RTNI 2	RTNI 1	RTNI 0

RTNI[4:0]: Set IH (line) period.

DIVI[1:0]: Set the division ratio of clocks for internal operations (DIV1-0). The internal operations are executed by the clocks, the frequency of which is divided according to the DIV1-0 setting. When changing the number of raster-rows to drive, adjust the frame frequency too. For details, see “Frame Frequency Adjustment Function”(p.178).

Table 32

RTNI[3:0]	clocks per line	DIVI[1:0]	division ratio	internal operation clock frequency
5'h00	Setting disabled	2'h0	1/1	fosc / 1
:	:	2'h1	1/2	fosc / 2
5'h0F	Setting disabled	2'h2	1/4	fosc / 4
5'h10	16 clocks	2'h3	1/8	fosc / 8
5'h11	17 clocks			
5'h12	18 clocks			
5'h13	19 clocks			
5'h14	20 clocks			
5'h15	21 clocks			
5'h16	22 clocks			
5'h17	23 clocks			
5'h18	24 clocks			
5'h19	25 clocks			
5'h1A	26 clocks			
5'h1B	27 clocks			
5'h1C	28 clocks			
5'h1D	29 clocks			
5'h1E	30 clocks			
5'h1F	31 clocks			

Note 1) fosc : R-C oscillation frequency

Formula for frame frequency

$$\text{frame frequency} = \frac{f_{\text{osc}}}{\text{Number of clock per line} \times \text{division ratio} \times (\text{Line} + \text{FP} + \text{BP})} \quad [\text{Hz}]$$

fosc : R-C oscillation frequency
Line : Number of drive raster-rows (NL bit)
division ration : DIV1 bit
clocks per line : RTNI bit

External Display Interface Control 2 (R00Eh)

R/W	RS	IB15	IB14	IB13	IB12	IB11	IB10	IB9	IB8	IB7	IB6	IB5	IB4	IB3	IB2	IB1	IB0
W	1	0	0	0	0	0	0	DIVE 1	DIVE 0	0	RTNE 6	RTNE 5	RTNE 4	RTNE 3	RTNE 2	RTNE 1	RTNE 0

RTNE[6:0]: Specify the number of clocks for internal operation per 1H (line). Set the value of the number of DOTCLK input in 1H period, divided by the division ratio.

DIVE[1:0]: Set the internal division ratio of DOTCLK (DIVE). The internal operation is executed according to the clocks divided by the division ratio set by DIVE.

Table 33

RTNE[6:0]	Clocks per line	DIVE[1:0]	Division	Internal operation clock frequency
7'h00	Setting disabled	2'h0	Setting disabled	
:	:	2'h1	1/4	fdotclk / 4
7'h0F	Setting disabled	2'h2	1/8	fdotclk / 8
7'h10	16 clocks	2'h3	1/16	fdotclk / 16
7'h11	17 clocks			fdotclk: DOTCLK frequency
7'h12	18 clocks			
:	:			
7'h7D	125 clocks			
7'h7E	126 clocks			
7'h7F	127 clocks			

External Display Interface Control 3 (R00Fh)

R/W	RS	IB15	IB14	IB13	IB12	IB11	IB10	IB9	IB8	IB7	IB6	IB5	IB4	IB3	IB2	IB1	IB0
W	1	0	0	0	0	0	0	0	0	0	0	0	VSPL	HSPLE	0	EPL	DPL

DPL: Specify the polarities of signals on DOTCLK pin.

DPL=0: Input data on a rising edge of DOTCLK.

DPL=1: Input data on a falling edge of DOTCLK.

EPL: Specify the polarities of signals on ENABLE pin.

EDL = 0 Data are written to PD17 to PD 0 when ENABLE = 0. No data are written when ENABLE = 1.

EDL = 1 Data are written to PD17 to PD 0 when ENABLE = 1. No data are written when ENABLE = 0.

HSPL: Specify the polarities of signals on HSYNC pin.

HSPL=0: Low active.

HSPL=1: High active.

VSPL: Specify the polarities of signals on VSYNC pin.

VSPL=0: Low active.

VSPL=1: High active.

Gate Driver/LTPS LCD Panel Interface Control 1 (R010h)

R/W	RS	IB15	IB14	IB13	IB12	IB11	IB10	IB9	IB8	IB7	IB6	IB5	IB4	IB3	IB2	IB1	IB0
W	1	0	0	0	FWI 4	FWI 3	FWI 2	FWI 1	FWI 0	0	0	0	0	0	FTI2	FTI1	FTI0

FTI[2:0]: FTI bits specify the rising position of FLM during display operation with internal clocks (DM = 2'h0 or 2'h2) when LTPS = 1. The setting of this register is invalid when LTPS = 0. In this case, the rising position of FLM is at a reference point.

FWI[4:0]: FWI bits specifies the width of “High” of FLM during display operation with internal clocks (DM = 2'h0 or 2'h2) when LTPS = 1. The setting of this register is invalid when LTPS = 0. In this case, the width of “High” of FLM is 1H.

See the figures (page 66, 67) with regard to how the signal waveform of each gate driver and LTPS LCD panel interface are controlled by these settings.

Table 34

FTI[2:0]	FLM Rising position	FWI[4:0]	FLM “High” width
2'h0	0 clock	5'h00	0 clock
2'h1	1 clock	5'h01	1 clock
2'h2	2 clocks	5'h02	2 clocks
2'h3	3 clocks	5'h03	3 clocks
		:	:
		5'h1D	29 clocks
		5'h1E	30 clocks
		5'h1F	31 clocks

Note 1) The clocks in the tables are measured from the reference point. The reference point is the position where SFTCLK rises when the rising position of SFTCLK is set to 0 clock.

Gate Driver/LTPS LCD Panel Interface Control 2 (R011h)

R/W	RS	IB15	IB14	IB13	IB12	IB11	IB10	IB9	IB8	IB7	IB6	IB5	IB4	IB3	IB2	IB1	IB0
W	1	0	0	0	SWI 4	SWI 3	SWI 2	SWI 1	SWI 0	0	0	0	0	0	0	STI1	STI0

STI[1:0]: STI bits specifies the rising position of SFTCLK1/2 during display operation with internal clocks (DM = 2'h0 or 2'h2) when LTPS = 1. The setting of this register is invalid when LTPS = 0. In this case, the rising position of CL1 is 8 clocks away from a reference point.

SWI[4:0]: SWI bits specifies the width of "High" of SFTCLK1/2 during display operation with internal clocks (DM = 2'h0 or 2'h2) when LTPS = 1. The setting of this register is invalid when LTPS = 0. In this case, the falling position of CL1 is at a reference point.

See the figures (page 66, 67) with regard to how the signal waveform of each gate driver and LTPS LCD panel interface are controlled by these settings.

Table 35

STI[1:0]	CL1/SFTCLK1, 2 Rising position	SWI[4:0]	CL1/SFTCLK1, 2 "High" width
2'h0	0 clock	5'h00	0 clock
2'h1	1 clock	5'h01	1 clock
2'h2	2 clocks	5'h02	2 clocks
2'h3	3 clocks	5'h03	3 clocks
		:	:
		5'h1D	29 clocks
		5'h1E	30 clocks
		5'h1F	31 clocks

Note 1) The clocks in the tables are measured from a reference point. The reference point is the position where SFTCLK rises when the rising position of SFTCLK is set to 0 clock.

Gate Driver/LTPS LCD Panel Interface Control 3 (R012h)

R/W	RS	IB15	IB14	IB13	IB12	IB11	IB10	IB9	IB8	IB7	IB6	IB5	IB4	IB3	IB2	IB1	IB0
W	1	0	0	0	0	0	0	0	0	0	0	0	0	0	0	SDTI 1	SDTI 0

SDTI[1:0]: Specify the delay from a reference point of the source output during display operation with internal clocks (DM = 2'h0 or 2'h2).

See the figures (page 66, 67) with regard to how the signal waveform of each gate driver and LTPS LCD panel interface are controlled by these settings.

Table 36

SDTI[1:0]	Source output delay
2'h0	1 clock
2'h1	2 clocks
2'h2	3 clocks
2'h3	4 clocks

Note 1) The clocks in the tables are measured from a reference point. The reference point is the position where SFTCLK rises when the rising position of SFTCLK is set to 0 clock.

Gate Driver/LTPS LCD Panel Interface Control 4 (R013h)

R/W	RS	IB15	IB14	IB13	IB12	IB11	IB10	IB9	IB8	IB7	IB6	IB5	IB4	IB3	IB2	IB1	IB0
W	1	0	0	0	DPW I4	DPW I3	DPW I2	DPW I1	DPW I0	0	0	0	0	0	0	DPTI 1	DPTI 0

DPTI[1:0]: Specify the rising position of DISPTMG during display operation with internal clocks (DM = 2'h0 or 2'h2).

DPWI[4:0]: DPWI bits specifies the width of “High” of DISPTMG during display operation with internal clocks (DM = 2'h0 or 2'h2) when LTPS = 1. The setting of this register is invalid when LTPS = 0. In this case, the falling position of CL1 is at a reference point.

See the figures (page 66, 67) with regard to how the signal waveform of each gate driver and LTPS LCD panel interface are controlled by these settings.

Table 37

DPTI[1:0]	DISPTMG Rising position	DPWI[4:0]	DISPTMG “High” width
2'h0	0 clock	5'h00	0 clock
2'h1	1 clock	5'h01	1 clock
2'h2	2 clocks	5'h02	2 clocks
2'h3	3 clocks	5'h03	3 clocks
		:	:
		5'h1D	29 clocks
		5'h1E	30 clocks
		5'h1F	31 clocks

Note 1) The clocks in the tables are measured from a reference point. The reference point is the position where SFTCLK rises when the rising position of SFTCLK is set to 0 clock.

Note 2) The gate non-overlap period can be set to 0 when DPTI = “2'h0” and DPWI is set to the number of clocks more than that of the 1H period.

Gate Driver/LTPS LCD Panel Interface Control 5 (R015h)

R/W	RS	IB15	IB14	IB13	IB12	IB11	IB10	IB9	IB8	IB7	IB6	IB5	IB4	IB3	IB2	IB1	IB0
W	1	0	0	0	0	0	0	EQW I1	EQW I0	0	0	0	0	0	0	0	0

EQWI[1:0]: Specify the width of “High” of EQ during display operation with internal clocks (DM = 2’h0 or 2’h2).

See the figures (page 66, 67) with regard to how the signal waveform of each gate driver and LTPS LCD panel interface are controlled by these settings. Also see “Equalizing Function” for details on equalization.

Table 38

EQWI[1:0]	EQ “High” width
2’h0	0 clock
2’h1	1 clock
2’h2	2 clocks
2’h3	3 clocks

Note 1) The clocks in the tables are measured from the source output alternating point.

Gate Driver/LTPS LCD Panel Interface Control 6 (R016h)

R/W	RS	IB15	IB14	IB13	IB12	IB11	IB10	IB9	IB8	IB7	IB6	IB5	IB4	IB3	IB2	IB1	IB0
W	1	0	0	FWE 5	FWE 4	FWE 3	FWE 2	FWE 1	FWE 0	0	0	0	0	0	FTE2	FTE1	FTE0

FTE[2:0]: FTE bits specifies the rising position of FLM during display operation with DOTCLK (DM = 2'h1) when LTPS = 1. The setting of this register setting is invalid when LTPS = 0. In this case, the rising position of FLM is at a reference point.

FWE[5:0]: FWE bits specifies the width of "High" of FLM during display operation with DOTCLK (DM = 2'h1) when LTPS = 1. The register setting is invalid when LTPS = 0. In this case, the width of "High" of FLM is 1H.

See the figures (page 66, 67) with regard to how the signal waveform of each gate driver and LTPS LCD panel interface are controlled by these settings.

Table 39

FTE[2:0]	FLM Rising position	FWE[5:0]	FLM "High" width
3'h0	0 clock	6'h00	0 clock
3'h1	1 clock	6'h01	1 clock
3'h2	2 clocks	6'h02	2 clocks
3'h3	3 clocks	6'h03	3 clocks
3'h4	4 clocks	:	:
3'h5	5 clocks	6'h3D	61 clocks
3'h6	6 clocks	6'h3E	62 clocks
3'h7	7 clocks	6'h3F	63 clocks

Note 1) The clocks in the tables are DOTCLK / division ratio for the 1H period, measured from a reference point. The reference point is the position where SFTCLK rises when the rising position of SFTCLK is set to 0 clock.

Gate Driver/LTPS LCD Panel Interface Control 7 (R017h)

R/W	RS	IB15	IB14	IB13	IB12	IB11	IB10	IB9	IB8	IB7	IB6	IB5	IB4	IB3	IB2	IB1	IB0
W	1	0	0	SWE 5	SWE 4	SWE 3	SWE 2	SWE 1	SWE 0	0	0	0	0	0	STE2	STE1	STE0

STE[2:0]: STE bits specifies the rising position of SFTCLK1/2 during display operation with DOTCLK (DM = 2'h1) when LTPS = 1. The register setting is invalid when LTPS = 0. In this case, the rising position of CL1 is 8 clocks away from a reference point.

SWE[5:0]: SWE bits specifies the width of "High" of SFTCLK1/2 during display operation with DOTCLK (DM = 2'h1) when LTPS = 1. The register setting is invalid when LTPS = 0. In this case, the falling position of CL1 is at a reference point.

See the figures (page 66, 67) with regard to how the signal waveform of each gate driver and LTPS LCD panel interface are controlled by these settings.

Table 40

STE[2:0]	CL1/SFTCLK1,2 Rising position	SWE[5:0]	CL1/SFTCLK1,2 "High" width
3'h0	0 clock	6'h00	0 clock
3'h1	1 clock	6'h01	1 clock
3'h2	2 clocks	6'h02	2 clocks
3'h3	3 clocks	6'h03	3 clocks
3'h4	4 clocks	:	:
3'h5	5 clocks	6'h3D	61 clocks
3'h6	6 clocks	6'h3E	62 clocks
3'h7	7 clocks	6'h3F	63 clocks

Note 1) The clocks in the tables are DOTCLK / division ratio for the 1H period, measured from a reference point. The reference point is the position where SFTCLK rises when the rising position of SFTCLK is set to 0 clock.

Gate Driver/LTPS LCD Panel Interface Control 8 (R018h)

R/W	RS	IB15	IB14	IB13	IB12	IB11	IB10	IB9	IB8	IB7	IB6	IB5	IB4	IB3	IB2	IB1	IB0
W	1	0	0	0	0	0	0	0	0	0	0	0	0	0	SDTE 2	SDTE 1	SDTE 0

SDTE[2:0]: Specify the delay from a reference point of the source output during display operation with DOTCLK (DM = 2'h1).

See the figures (page 66, 67) with regard to how the signal waveform of each gate driver and LTPS LCD panel interface are controlled by these settings.

Table 41

SDTE[2:0]	Source output delay
3'h0	1 clock
3'h1	2 clocks
3'h2	3 clocks
3'h3	4 clocks
3'h4	5 clocks
3'h5	6 clocks
3'h6	7 clocks
3'h7	Setting disabled

Note 1) The clocks in the tables are DOTCLK / division ratio for the 1H period, measured from a reference point. The reference point is the position where SFTCLK rises when the rising position of SFTCLK is set to 0 clock.

Gate Driver/LTPS LCD Panel Interface Control 9 (R019h)

R/W	RS	IB15	IB14	IB13	IB12	IB11	IB10	IB9	IB8	IB7	IB6	IB5	IB4	IB3	IB2	IB1	IB0
W	1	0	0	DPWE5	DPWE4	DPWE3	DPWE2	DPWE1	DPWE0	0	0	0	0	0	DPTE2	DPTE1	DPTE0

DPTE[2:0]: Specify the rising position of DISPTMG during display operation with DOTCLK (DM = 2'h1).

DPWE[5:0]: DPWE specifies the width of “High” of DISPTMG during display operation with DOTCLK (DM = 2'h1) when LTPS = 1. The register setting is invalid when LTPS = 0. In this case, the falling position of CL1 is at a reference point.

See the figures (page 66, 67) with regard to how the signal waveform of each gate driver and LTPS LCD panel interface are controlled by these settings.

Table 42

DPTE[2:0]	DISPTMG Rising position	DPWE[5:0]	DISPTMG “High” width
3'h0	0 clock	6'h00	0 clock
3'h1	1 clock	6'h01	1 clock
3'h2	2 clocks	6'h02	2 clocks
3'h3	3 clocks	6'h03	3 clocks
3'h4	4 clocks	:	:
3'h5	5 clocks	6'h3D	61 clocks
3'h6	6 clocks	6'h3E	62 clocks
3'h7	7 clocks	6'h3F	63 clocks

Note 1) The clocks in the tables are DOTCLK / division ratio for the 1H period, measured from a reference point. The reference point is the position where SFTCLK rises when the rising position of SFTCLK is set to 0 clock.

Note 2) The gate non-overlap period can be set to 0 when DPT1 = “2'h0” and DPWI is set to the number of clocks more than that of the 1H period.

Gate Driver/LTPS LCD Panel Interface Control 10 (R01Bh)

R/W	RS	IB15	IB14	IB13	IB12	IB11	IB10	IB9	IB8	IB7	IB6	IB5	IB4	IB3	IB2	IB1	IB0
W	1	0	0	0	0	0	EQW E2	EQW E1	EQW E0	0	0	0	0	0	0	0	0

EQWE[2:0]: Specify the width of “High” of EQ DISPTMG during display operation with DOTCLK (DM = 2’h1).

See the figures (page 66, 67) with regard to how the signal waveform of each gate driver and LTPS LCD panel interface are controlled by these settings. Also see “Equalizing Function” for details on equalization.

Table 43

EQWE[2:0]	EQ “High” width
3’h0	0 clock
3’h1	1 clock
3’h2	2 clocks
3’h3	3 clocks
3’h4	4 clocks
3’h5	5 clocks
3’h6	6 clocks
3’h7	7 clocks

Note 1) The clocks in the tables are DOTCLK / division ratio for the 1H period, measured from the source output change.

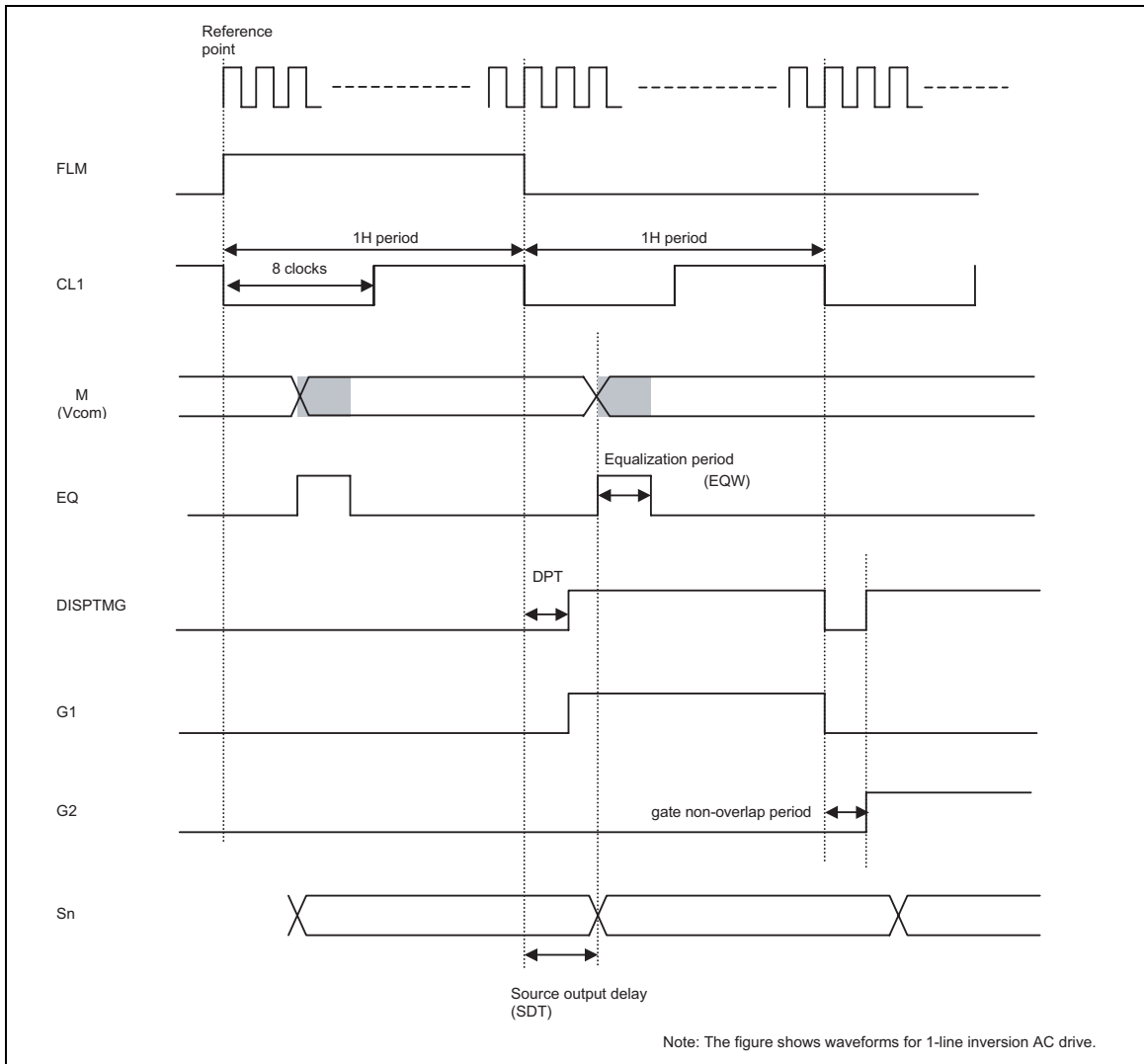

Output waveforms of a-Si TFT panel (LTPS = 0)

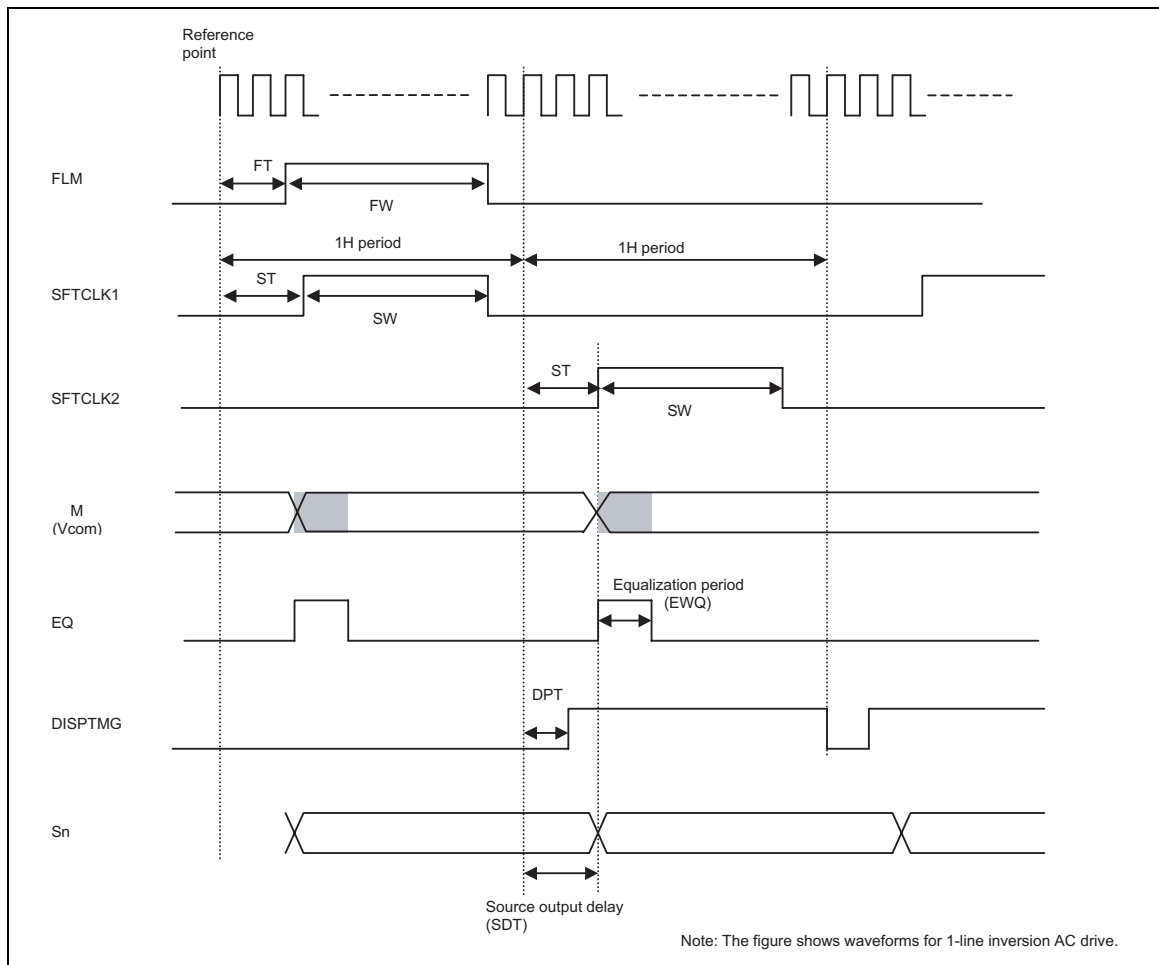

Output waveforms of low-temperature poly-Si TFT panel (LTPS = 1)

Power control 1 (R100h)

R/W	RS	IB15	IB14	IB13	IB12	IB11	IB10	IB9	IB8	IB7	IB6	IB5	IB4	IB3	IB2	IB1	IB0
W	1	DC 4	DC 3	0	0	0	SAP 2	SAP 1	SAP 0	0	AP 2	AP 1	AP 0	0	DS TB	SLP	STB

STB: When STB = 1, the HD66781 enters into the standby mode. In the standby mode, display operation is completely halted, and all internal operations including the internal R-C oscillator and reception of external clock pulse, are halted. Only instructions to release from the standby mode (STB = 0) and to start oscillation are accepted during the standby mode.

In the standby mode, a serial transfer to the gate driver/power supply IC cannot be made and it requires retransfer after release from the standby mode. Also in the standby mode, any change in the GRAM data or instruction setting cannot be made, but GRAM data are retained.

SLP: When SLP = 1, the HD66781 enters into the sleep mode. In the sleep mode, internal display operation is halted except the R-C oscillator to reduce current consumption. No change is made to the GRAM data or instructions during the sleep mode, and the GRAM data and the instructions are retained.

DSTB: When DSTB = 1, the HD66781 enters into the deep standby mode, where the power supply for the internal logic is turned off to save more power than the standby mode. The GRAM data and the instruction setting are destroyed in the deep standby mode and it requires resetting after release from the deep standby mode. Also in the deep standby mode, a serial transfer to the gate driver cannot be made and it requires a retransfer after the release from the deep standby mode.

AP[2:0]: Adjust the amount of constant current in the operational amplifier in the liquid crystal drive power supply. When the amount of constant current is set large, the liquid crystal drive capacity will be enhanced and the display quality will improve, while the current consumption will increase. Select an optimum amount of current taking both the display quality and the current consumption into account. When no display operation is required, set AP[2:0] = "3'h0" to halt the operation of operational amplifier and step-up circuits to reduce the current consumption. Also if AP[2:0] is set to other than 0, the clock for the step-up circuit DCCLK is output.

SAP[2:0]: Adjust the amount of constant current in the operational amplifier of source driver. When the amount of constant current is set large, the liquid crystal drive capacity is enhanced and the display quality will improve, while the current consumption will increase. Select an optimum amount of current taking both the display quality and the current consumption into account. When no display operation is required, set SAP[2:0] = "3'h0" to halt the operation of operational amplifier and step-up circuits to reduce the current consumption.

DC[4:3]: Select the frequency of clocks for the step-up circuit (DCCLK). If the DCCLK frequency is set high, display quality is enhanced due to increased drive capacity of step-up circuit, while power consumption will be increased. Make an adjustment taking both display quality and power consumption into consideration.

Note: The AP[2:0] in the above description is the instruction bits for gate driver/power supply IC. The instruction setting in the AP[2:0] must be transferred to the gate driver/power supply IC before an instruction is executed. For details, see "Gate driver/power supply IC Serial Transfer".

Table 44 SAP setting**DC setting**

SAP[2:0]	Current in the operational amplifier	DC[4:3]	DCCLK frequency
3'h0	operation halt : op-amp, step-up circuit	2'h0	Fosc / 4
3'h1	op-amp constant current flow rate : 0.65	2'h1	fosc / 8
3'h2	op-amp constant current flow rate : 0.80	2'h2	fosc / 16
3'h3	op-amp constant current flow rate : 1.00	2'h3	fosc / 32
3'h4	op-amp constant current flow rate : 1.35		
3'h5	op-amp constant current flow rate : 1.60		
3'h6	Setting disabled		
3'h7	Setting disabled		

Note 1) The amount of current in the above table is shown as a ratio against that of SAP[2:0] = 3'h3 as 1.

Gate Driver/ Power Supply IC Interface Control 1 (R110h)

R/W	RS	IB15	IB14	IB13	IB12	IB11	IB10	IB9	IB8	IB7	IB6	IB5	IB4	IB3	IB2	IB1	IB0
W	1	0	0	0	0	0	0	0	TE	0	0	0	0	0	IDX 2	IDX 1	IDX 0
R	1	0	0	0	0	0	0	0	TE	0	0	0	0	0	IDX 2	IDX 1	IDX 0

Gate Driver/ Power Supply IC Interface Control 2 (R111h)

R/W	RS	IB15	IB14	IB13	IB12	IB11	IB10	IB9	IB8	IB7	IB6	IB5	IB4	IB3	IB2	IB1	IB0
W	1	0	0	0	TB 12	TB 11	TB 10	TB 9	TB 8	TB 7	TB 6	TB 5	TB 4	TB 3	TB 2	TB 1	TB 0

IDX[2:0]: The index register of the instruction, which is transferred to the gate driver/power supply IC. The instruction that corresponds to the index as determined by the IDX[2:0] setting is transferred to the gate driver or power supply IC through a serial interface for the gate/power supply IC. The following figures illustrates the bit array with which instructions are transferred. The upper 3 bits in the figures corresponds to the IDX[2:0] bits. The instructions of the indexes determined by the IDX[2:0] settings as below are transferred to the gate driver/power supply IC.

When any change will be made to the instruction setting to the gate driver/power supply IC, the setting must be made first in the R111h register of HD 66781 before making a setting for IDX[2:0]. The transfer start (TE = 1) starts transferring the instructions, which is then followed by the execution.

TE: The ENABLE for the serial transfer to the gate driver/power supply IC. TE=0 enables a serial transfer. TE=1 starts a transfer to the gate driver/power supply IC. When the transfer is completed, TE=0 is returned.

A serial transfer takes 18 clocks at maximum (with reference to internal clocks). Do not make any changes to the instructions that are being transferred. Other instructions can be executable even during the instruction transfer.

Note 1) The transfer of the NL[5:0], AP[2:0], FLD[1:0] settings to the gate driver/power supply IC must be made right after the instruction setting of HD66781. Make a same setting to the HD66781 and HD66783/HD667P21 with regard to NL, AP, FLD registers. Otherwise, a proper operation is not guaranteed.

Note 2) As in the following figures, the bits to which no register is assigned must be overwritten with "0" or "1".

HD66783 Instructions															
IDX2	IDX1	IDX0	TB12	TB11	TB10	TB9	TB8	TB7	TB6	TB5	TB4	TB3	TB2	TB1	TB0
0	0	0	0	GON	VCO MG	BT[2]	BT[1]	BT[0]	DC0 [2]	DC0 [1]	DC0 [0]	AP [2]	AP [1]	AP [0]	0
0	0	1	0	DK	1	EQM	0	PON	VRH [3]	VRH [2]	VRH [1]	VRH [0]	VC [2]	VC [1]	VC [0]
0	1	0	DC1 [2]	DC1 [1]	DC1 [0]	VDV [4]	VDV [3]	VDV [2]	VDV [1]	VDV [0]	VCM [4]	VCM [3]	VCM [2]	VCM [1]	VCM [0]
0	1	1	Setting disabled												
1	0	0	Setting disabled												
1	0	1	Setting disabled												
1	1	0	GS	NL [5]	NL [4]	NL [3]	NL [2]	NL [1]	NL [0]	SC N [5]	SC N [4]	SC N [3]	SC N [2]	SC N [1]	SC N [0]
1	1	1	0	0	0	0	0	0	0	0	0	0	0	NL [1]	NL [0]

HD667P21 Instructions															
IDX2	IDX1	IDX0	TB12	TB11	TB10	TB9	TB8	TB7	TB6	TB5	TB4	TB3	TB2	TB1	TB0
0	0	0	0	GON	VCO MG	BT[2]	BT[1]	BT[0]	DC [2]	DC [1]	DC [0]	AP [2]	AP [1]	AP [0]	0
0	0	1	0	0	0	0	0	PON	VRH [3]	VRH [2]	VRH [1]	VRH [0]	VC [2]	VC [1]	VC [0]
0	0	1	0	1	0	DK [1]	DK [0]	0	0	0	0	0	0	0	0
0	1	0	0	0	0	VDV [4]	VDV [3]	VDV [2]	VDV [1]	VDV [0]	VCM [4]	VCM [3]	VCM [2]	VCM [1]	VCM [0]
0	1	1	Setting disabled												
1	0	0	Setting disabled												
1	0	1	Setting disabled												
1	1	0	Setting disabled												
1	1	1	0	0	VGL [4]	VGL [3]	VGL [2]	VGL [1]	VGL [0]	0	VGH [4]	VGH [3]	VGH [2]	VGH [1]	VGH [0]

HD66783 / HD667P21 instructions

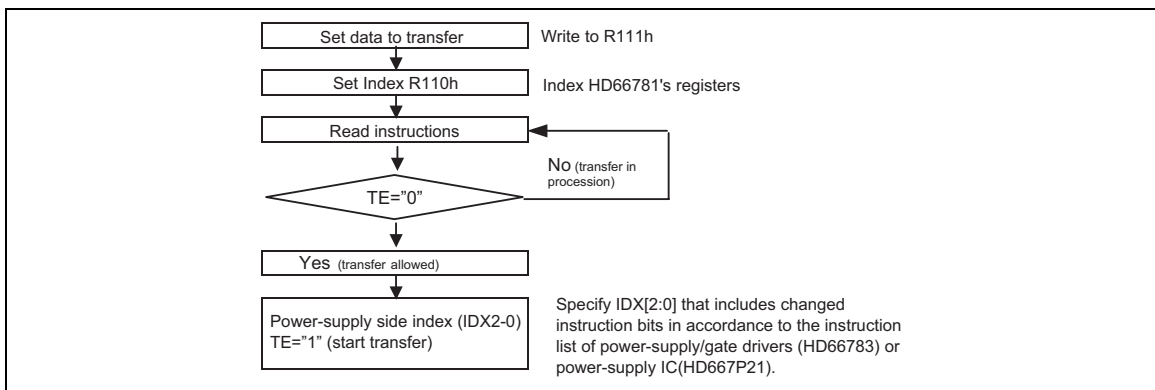

Serial transfer sequence: gate driver/power supply IC interface

Setting examples

1. Set DC1[2:0], VDV[4:0], VCM of HD66783 to 3'h2, 5'h2, 5'h3 respectively.
 - (1) Instruction set: R111h
 - (2) Data write: 16'h0843 (DC1[2:0]=3'h2, VDV[4:0]=5'h2, VCM[4:0]=5'h3)
 - (3) Instruction set: R110h
 - (4) Data read: (make sure TE=0)
 - (5) Data write: 16'h0102 (TE=1, IDX[2:0]=3'h2)

2. Set NL of HD66781 and HD66783 to 6'h20 (NL, AP, FLD are the registers that require a setting in both HD66781 and HD66783).
 - (1) Instruction set: R400h
 - (2) Data write: 16'h0020
 - ↓
 - (3) Instruction set: R111h
 - (4) Data write: 16'h0800 (GS=0, NL[5:0]=6'h20, SCN[5:0]=6'h00)
 - (5) Instruction set: R110h
 - (6) Data read: (make sure TE=0)
 - (7) Data write: 16'h0102 (TE=1, IDX[2:0]=3'h6)

Note 1) Make a same setting to the HD66781 and HD66783 at one time. (1) and (2) are the setting for the HD66781. (3)~(7) are the setting for the HD66783.

Common registers for HD66783 and HD667P21

BT[2:0]: Change the output scale of step-up circuits. Adjust the step-up scale according to the voltage in use. To set power consumption lower, it is necessary to set the step-up scale smaller. For details, see the datasheets of HD66783 and HD667P21.

VCOMG: Make settings for the output level of VcomL.

- | | |
|-----------|--|
| VCOMG = 0 | The low-side output of Vcom is fixed to GND and the instruction (VDV) setting becomes invalid. Outputs from VcomL and VCL are halted. For this reason, the VCOMG setting is related to the power-supply startup sequence. Make a VCOMG setting by following the power-supply setting sequence. |
| VCOMG = 1 | The low-side output of Vcom becomes VcomL. The output voltage of VcomL is set by instruction (VDV) setting. VCOMG = 1 is valid when PON = 1. |

VC[2:0]: Adjust the reference voltages of VREG1OUT, VREG2OUT, and Vci1 voltages according to Vci as the reference voltage. For details, see the datasheets of HD66783 and HD667P21.

VRH[3:0]: Set the amplifying scale of VREG1OUT with the values set in VC bits (REGP) as an input. For details, see the datasheets of HD66783 and HD667P21.

VCM[4:0]: Make a setting for VcomH (the “High” of Vcom). VcomH can be amplified to VREG1OUT x 0.41 ~ 1.00. When VCM = 5'h01, VcomH is not adjusted by the internal volume adjustment but by an external resistor from VcomR. For details on whether to generate the VcomH level with internal electronic volume or an external resistor, see the datasheets of HD66783 and HD667P21.

VDV[4:0]: Set the Vcom alternating amplitude. The setting is invalid without Vcom alternating drive. For details, see the datasheets of HD66783 and HD667P21.

Registers of HD66783

AP[2:0]: Adjust the amount of constant current in the operational amplifier in the liquid crystal drive power supply. When the amount of constant current is set large, the liquid crystal drive capacity is enhanced and the display quality will improve, while the current consumption will increase. Select an optimum amount of current taking both the display quality and the current consumption into account. When no display operation is required, set AP[2:0] = “3'h0” to halt the operation of operational amplifiers and step-up circuits to reduce the current consumption. To set AP[2:0] otherwise, it starts step-up circuits to output VGH. For details, see the datasheets of HD66783.

DC0[2:0]: Select the operation frequency of step-up circuit 1. If the step-up operation frequency is set high, display quality will be enhanced due to increased drive capacity of step-up circuit, while power consumption will be increased. Make an adjustment taking both display quality and power consumption into consideration. For details, see the datasheets of HD66783.

GON: When GON=0, the output level of G1~G320 pins of HD66783 becomes VGH and the Vcom level becomes GND.

PON: Set start/halt of VGL, VCL operations. Set PON according to the power supply start sequence.

PON=0: Halt
PON=1: Start

EQM: Select the operation mode of Vcom2 output. Set EQM = 0.

DK: Control the start-up of DDVDH. See “Instruction Setting Flow” (p.185) for details on the setting.

VCM[4:0]: Make a setting for VcomH (the High voltage of Vcom). VcomH can be amplified to the level $VREG1OUT \times 0.40 \sim 0.98$. When VCM[4:0] = 5'h0F, internal volume is halted and VcomH is adjusted by an external resistor from VcomR. See the datasheet of HD66783 whether to generate VcomH level with internal electronic volume or an external resistor.

DC1[2:0]: Select the operation frequency of step-up circuit 2. If the step-up operation frequency is set high, display quality will be enhanced due to increased drive capacity of step-up circuit, while power consumption will be increased. Make an adjustment taking both display quality and power consumption into consideration. See the datasheet of HD66783 for details.

SCN[5:0]: Set the start position of scanning gate bus line. For details, see the datasheets of HD66783.

NL[5:0]: Set the number of liquid crystal drive raster-rows. The number of raster-rows can be set to 8 multiples. The value should be set equal to or more than to drive the number of raster-rows required for the panel size.

Note: Set SCN[5:0] and NL[5:0] to satisfy the following equation:

$$(\text{Output start position}) + (\text{Number of drive raster-rows}) - 1 \leq 320 (\text{raster-rows})$$

GS: Set the scan direction of gate bus lines. The direction is changeable according to the gate driver's position on the assembly. For details, see the datasheets of HD66783.

FLD[1:0]: Set the number of valid lines to drive n-line interlacing. For details, see the datasheets of HD66783.

Registers of HD667P21

AP[2:0]: Adjust the amount of constant current in the operational amplifier in the liquid crystal drive power supply. When the amount of constant current is set large, the liquid crystal drive capacity will be enhanced and the display quality will improve, while the current consumption will increase. Select an optimum amount of current taking both the display quality and the current consumption into account. When no display operation is required, set AP[2:0] = “3'h0” to halt the operation of operational amplifier and step-up circuits to reduce the current consumption. If AP[2:0] is set otherwise, it starts step-up circuit to output VLOUT1, VLOUT2. For details, see the datasheets of HD667P21.

DC[2:0]: Select the operation frequency of step-up circuit 1. If the step-up operation frequency is set high, display quality will be enhanced due to increased drive capacity of step-up circuit, while power consumption will be increased. Make an adjustment taking both display quality and power consumption into consideration. For details, see the datasheets of HD66783.

GON: When GON=0, the Vcom level becomes GND.

PON: Set start/halt of VLOUT3 operation. Set PON according to the power supply start sequence.

PON=0: Halt

PON=1: Start

VCM[4:0]: Make a setting for VcomH (the High voltage of Vcom). VcomH can be amplified to the level $VREG1OUT \times 0.41 \sim 1.00$. When $VCM[4:0] = 5'h1F$, internal volume is halted and VcomH is adjusted by an external resistor from VcomR. See the datasheet of HD667P21 whether to generate VcomH level with internal electronic volume or an external resistor.

VGH[4:0]: Set the VGH regulator output level. The setting can be made from 2.82 to 4.06 times of REGP voltage.

VGL[4:0]: Set the VGL regulator output level. The setting can be made from -1.60 to -2.84 times of REGP voltage.

RAM Address set in horizontal/vertical directions (R200h/R201h)

R/W	RS	IB15	IB14	IB13	IB12	IB11	IB10	IB9	IB8	IB7	IB6	IB5	IB4	IB3	IB2	IB1	IB0
W	1	0	0	0	0	0	0	0	0	AD [7]	AD [6]	AD [5]	AD [4]	AD [3]	AD [2]	AD [1]	AD [0]
W	1	0	0	0	0	0	0	0	AD [16]	AD [15]	AD [14]	AD [13]	AD [12]	AD [11]	AD [10]	AD [9]	AD [8]

Note : Top R200h, Bottom R201h

AD[16:0]: Initialize GRAM address at AC (Address Counter). The address counter is automatically updated in accordance with AM, I/D settings after data are written to GRAM. Data can be written consecutively without making a new address setting. The address counter is not automatically updated when data are read out from GRAM.

Table 45 GRAM address range

AD[16:0]	GRAM Setting
17'h00000 – 17'h000EF	Bitmap data for G1
17'h00100 – 17'h001EF	Bitmap data for G2
17'h00200 – 17'h002EF	Bitmap data for G3
17'h00300 – 17'h003EF	Bitmap data for G4
17'h00400 – 17'h004EF	Bitmap data for G5
:	:
17'h13F00 – 17'h13CEF	Bitmap data for G317
17'h13F00 – 17'h13DEF	Bitmap data for G318
17'h13F00 – 17'h13EEF	Bitmap data for G319
17'h13F00 – 17'h13FEF	Bitmap data for G320

Note 1) An address set is made every frame within the GRAM address range set by AD[16:0] at the falling edge of VSYNC when RGB interface (RM=1) is selected.

Note 2) An address set is made when instructions are executed in the internal clock operation or the VSYNC interface mode (RM = 0).

Note 3) Register values are loaded in both horizontal/vertical address counters when a setting is made for either one of the R200h/R201h registers.

Write Data to GRAM (R202h)

R/W RS

W	1	The DB[17:0] pins are assigned to RAM write data (WD[17:0]) differently according to an interface.
RGB interface		The DB[17:0] pins are assigned to RAM write data (WD[17:0]) differently according to an interface .

WD[17:0]: All data are expanded into 18 bits internally before being written to GRAM. The way of expanding data into 18 bits is different according to the interface.

The grayscale level is selected according to the GRAM data. The address is automatically updated according to the setting with the AM and I/D bits after data are written to GRAM. During the standby mode, no access is allowed to GRAM. When the 8 or 16 bit interface modes are selected, the data in the MSB of R and B pixels are also written to the LSB of R and B pixels respectively to expand the 8/16-bit data into the 18-bit data internally.

During the RGB interface mode, when writing data to RAM through a system interface, make sure to avoid conflicts between writing through the RGB interface and writing through system interface.

When the 18-bit RGB interface is selected, the 18-bit data in PD17-0 bits are written, and 262,144 colors are available. When the 16-bit RGB interface is selected, the data in the MSB of R and B pixels are also written to the LSB of R and B pixels respectively, and 65,536 colors are available.

The upper 3 bits of OSD image data are used as a transmission-rate bit (α channel).

Table 46 BGR = 0

OSD	ODF	D17	D16	D15	D14	D13	D12	D11	D10	D9	D8	D7	D6	D5	D4	D3	D2	D1	D0
0	*	R5	R4	R3	R2	R1	R0	G5	G4	G3	G2	G1	G0	B5	B4	B3	B2	B1	B0
1	0	R5	R4	R3	R2	R1	$\alpha 2$	G5	G4	G3	G2	G1	$\alpha 1$	B5	B4	B3	B2	B1	$\alpha 0$
1	1	$\alpha 2$	$\alpha 1$	$\alpha 0$	R4	R3	R2	R1	R0	G4	G3	G2	G1	G0	B4	B3	B2	B1	B0

Table 47 BGR =1

OSD	ODF	D17	D16	D15	D14	D13	D12	D11	D10	D9	D8	D7	D6	D5	D4	D3	D2	D1	D0
0	*	B5	B4	B3	B2	B1	B0	G5	G4	G3	G2	G1	G0	R5	R4	R3	R2	R1	R0
1	0	B5	B4	B3	B2	B1	$\alpha 0$	G5	G4	G3	G2	G1	$\alpha 1$	R5	R4	R3	R2	R1	$\alpha 2$
1	1	$\alpha 0$	$\alpha 1$	$\alpha 2$	B4	B3	B2	B1	B0	G4	G3	G2	G1	G0	R4	R3	R2	R1	R0

Table 48 α channel

$\alpha 2$	$\alpha 1$	$\alpha 0$	transmission rate	displayed picture
0	0	0	0%	Base image display
0	0	1		Setting disabled
0	1	0	25%	Base image 75%+OSD 25%
0	1	1	75%	Base image 25%+OSD 75%
1	0	0	50%	Base image 50%+OSD 50%
1	0	1		Setting disabled
1	1	0	100%	OSD image display
1	1	1		Setting disabled

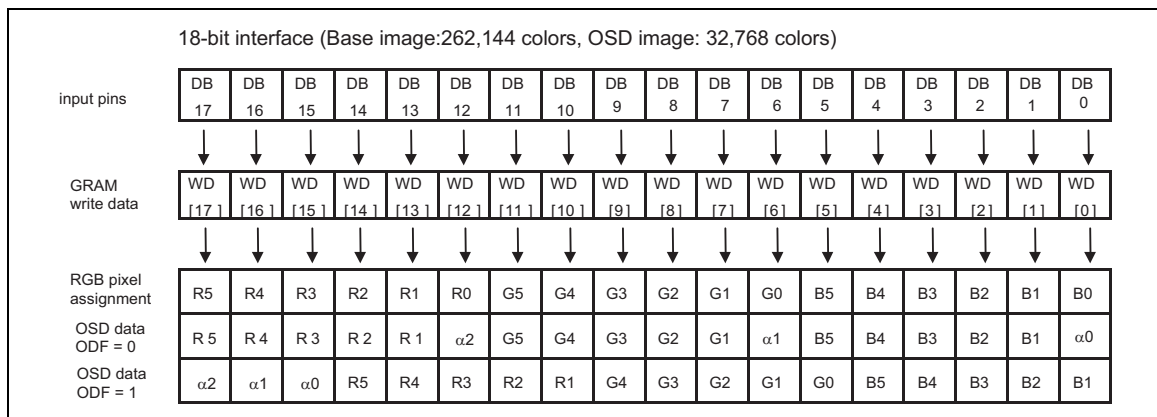

RAM data write in 18-bit interface (Base image 262,144 colors/OSD image 8,192 colors)

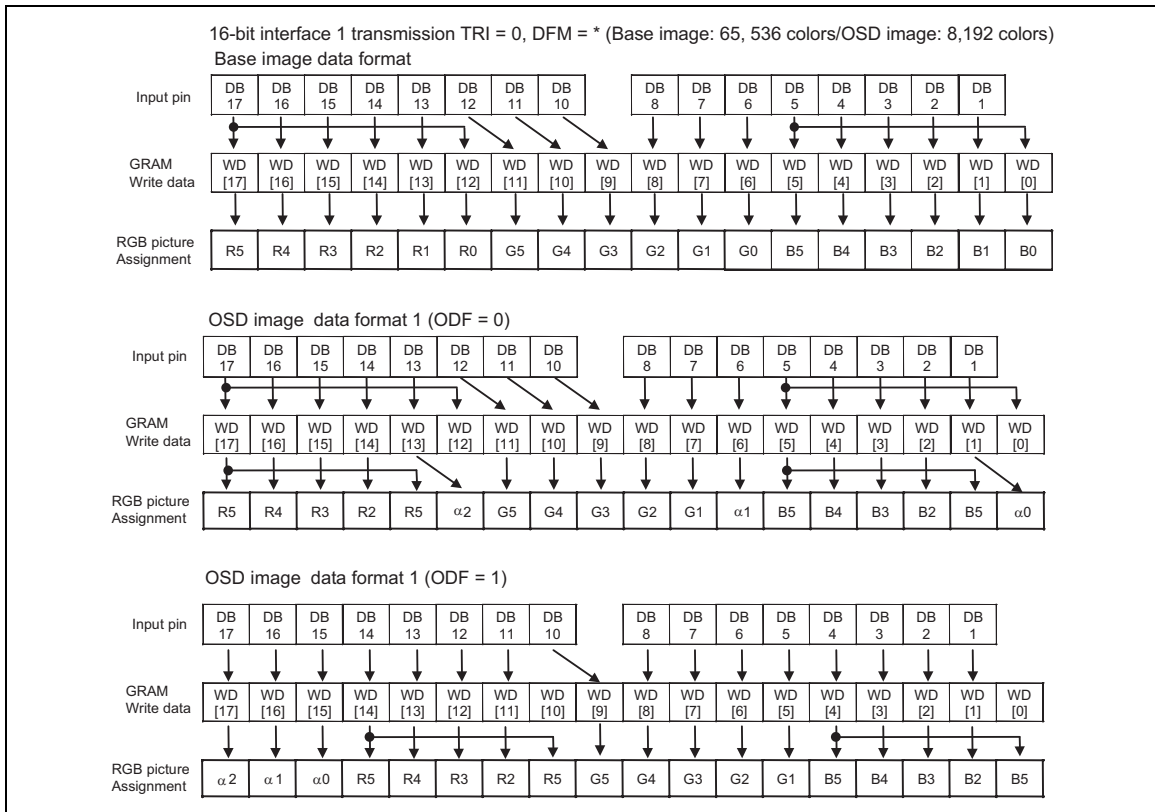

RAM data write in 16-bit interface (Base image 65,536 colors/OSD image 32,768 colors)

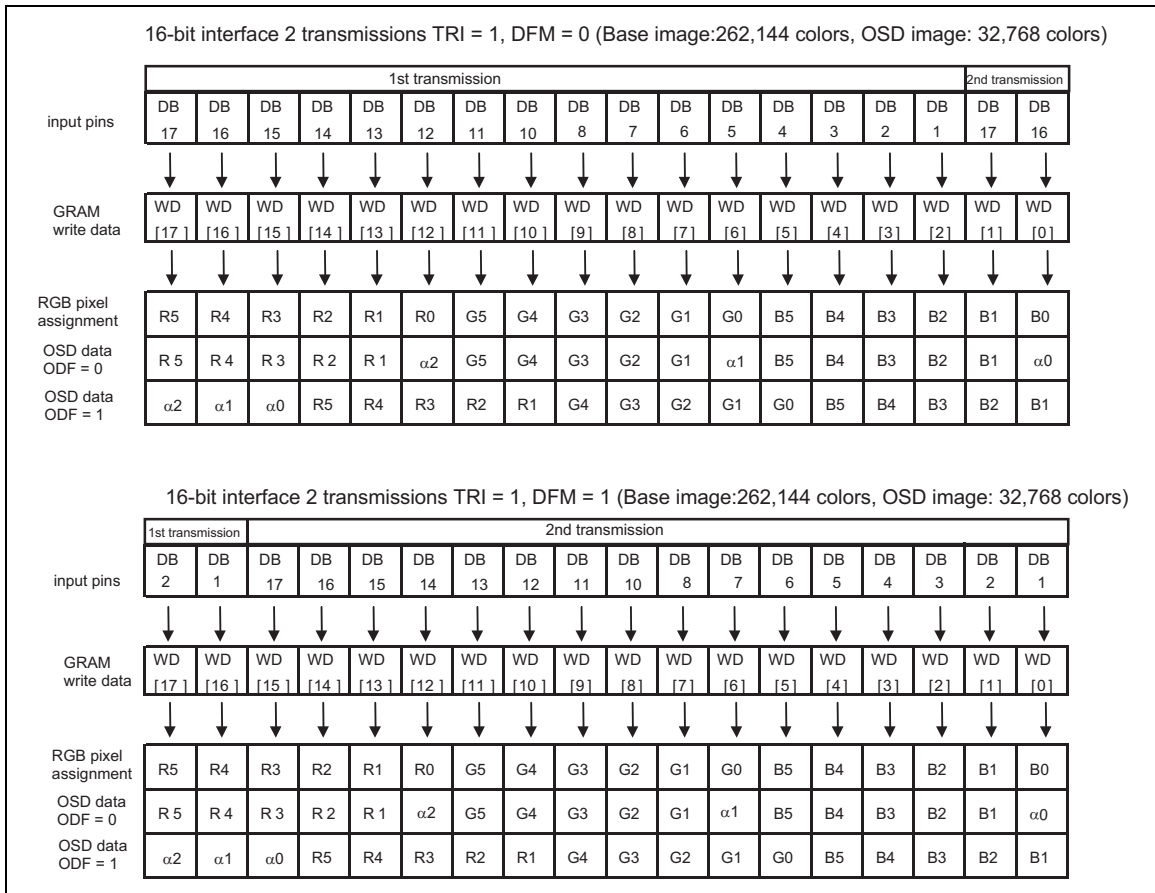

RAM data write in 16-bit interface (Base image 262,144 colors/OSD image 32,768 colors)

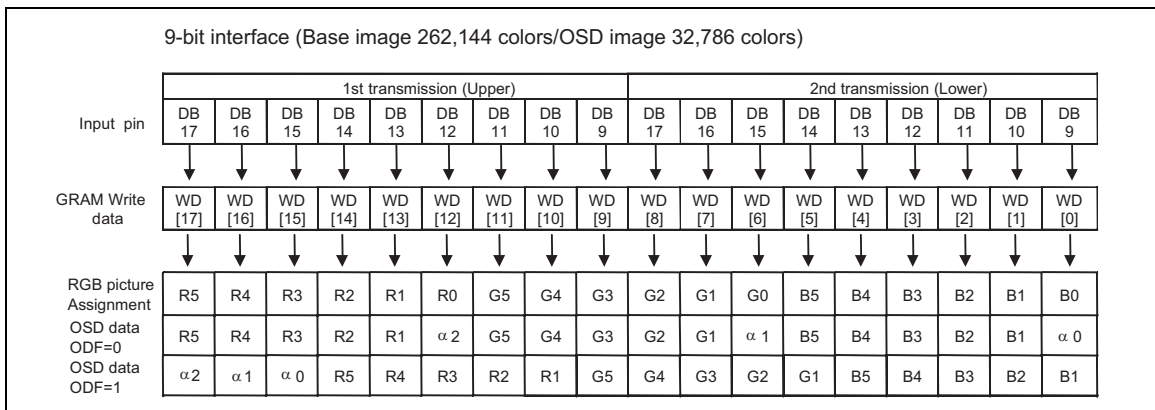

RAM data write in 9-bit interface (Base image 262,144 colors /OSD image 32,768 colors)

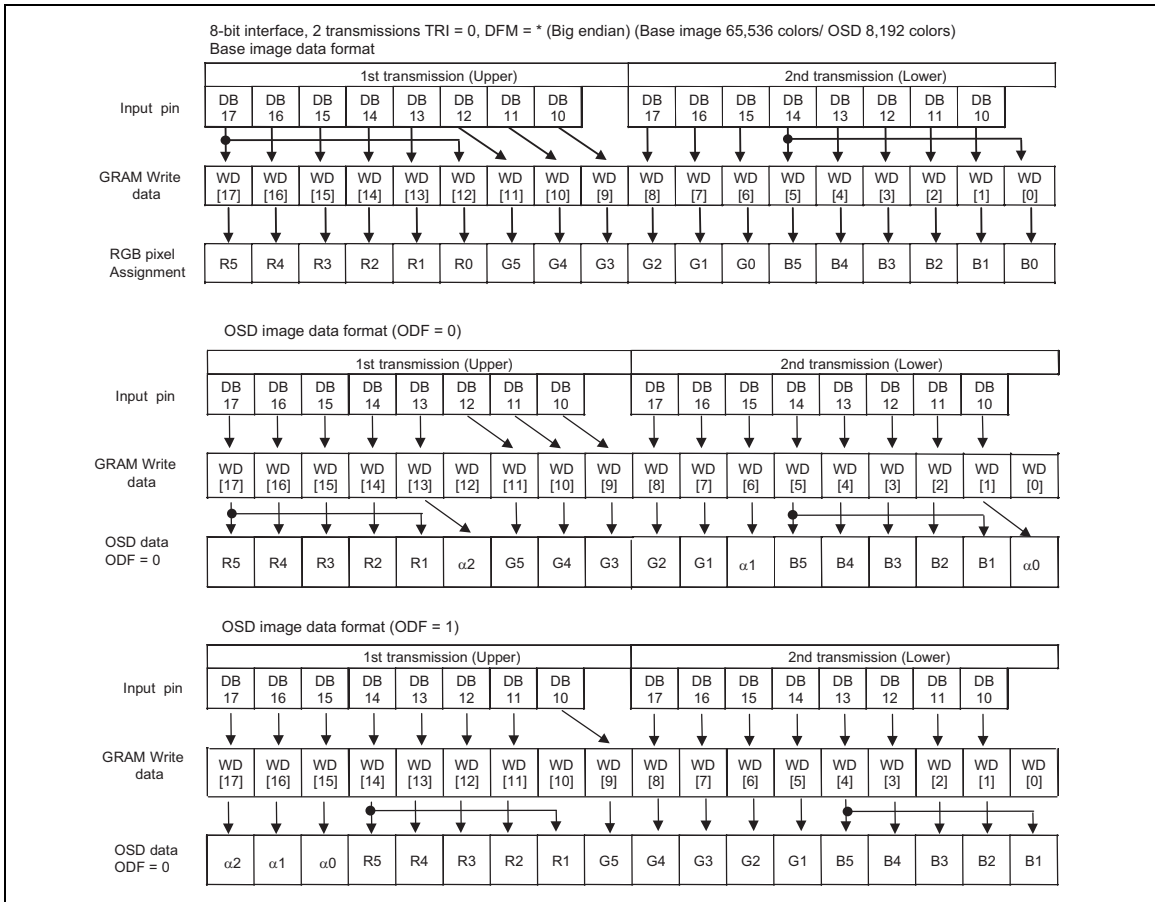

RAM data write in 8-bit interface, big endian (Base image/OSD image)

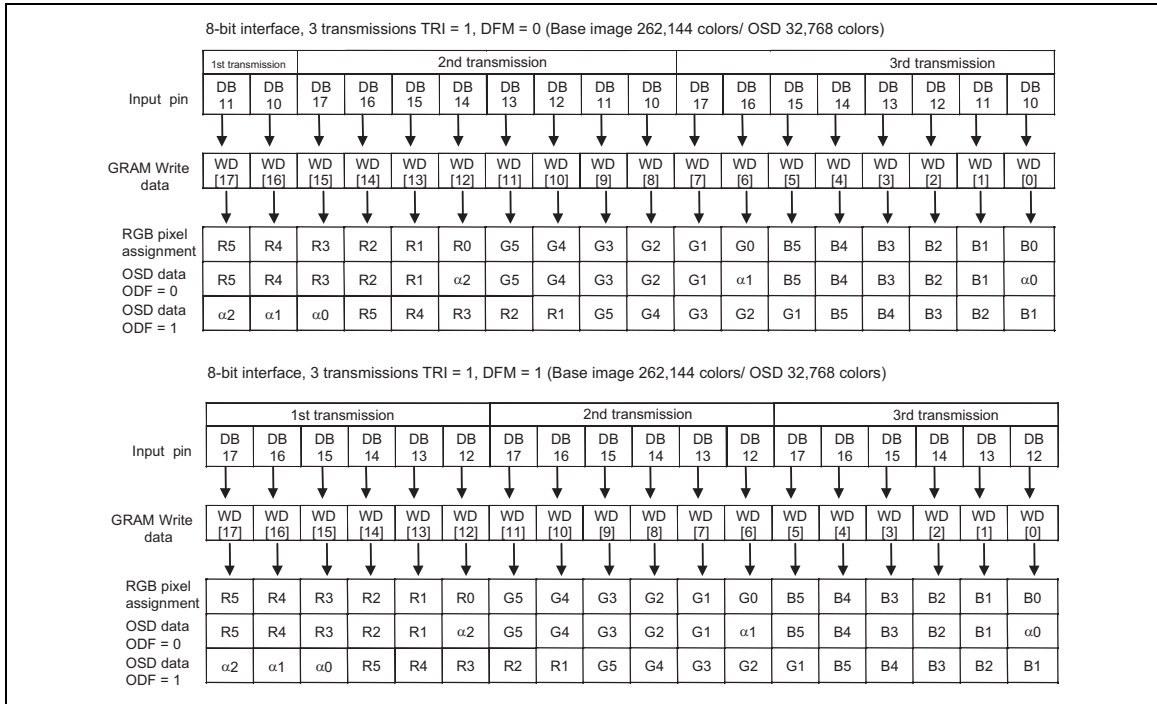

RAM data write in 8-bit interface, 3 transmissions (Base image/OSD image)

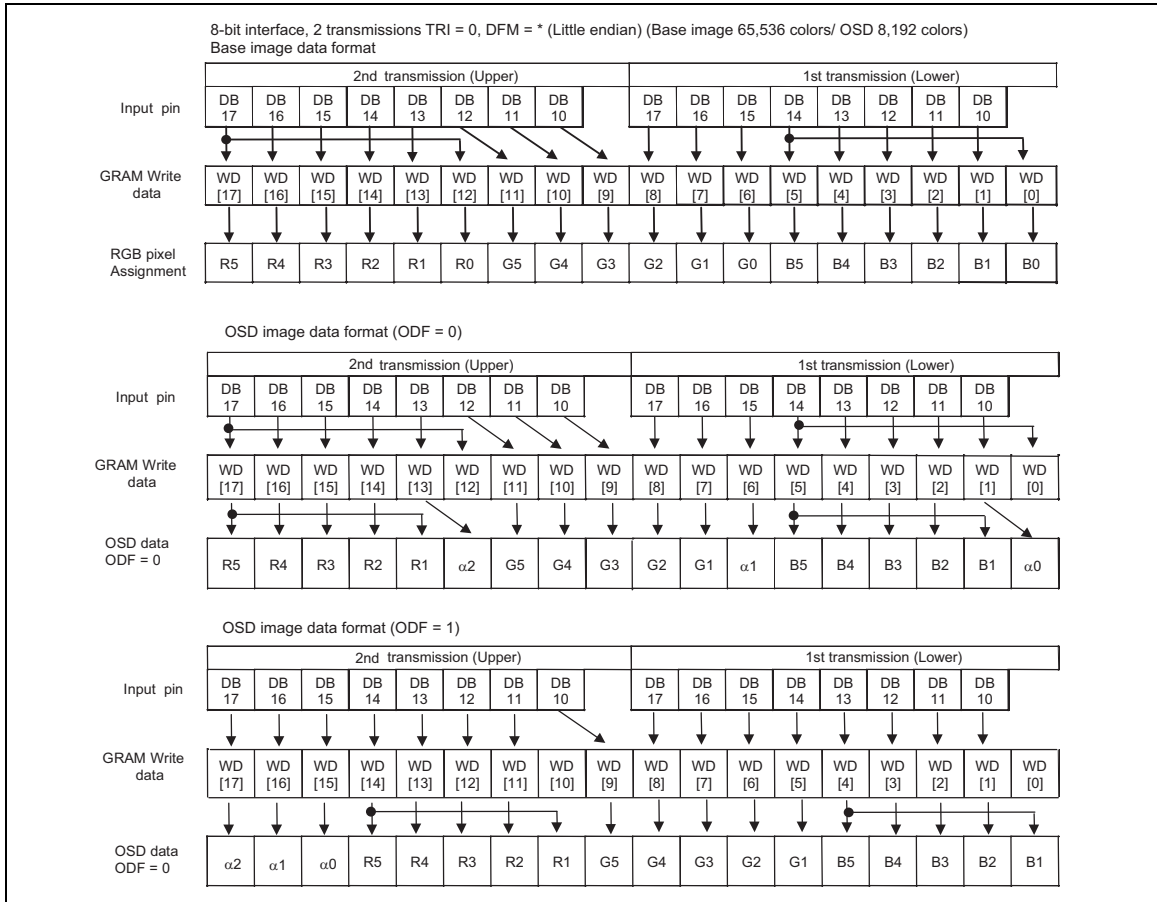

RAM data write in 8-bit interface, little endian (Base image/OSD image)

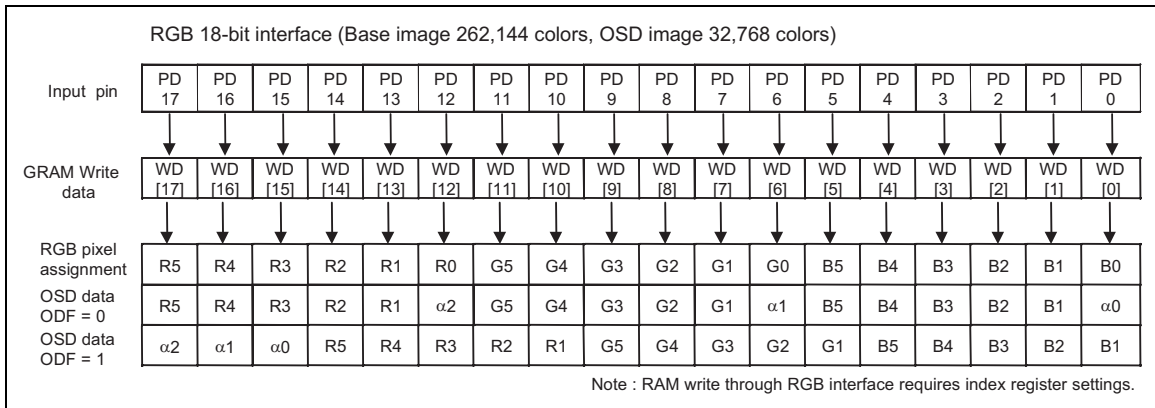

RGB 18-bit interface (Base/OSD image display)

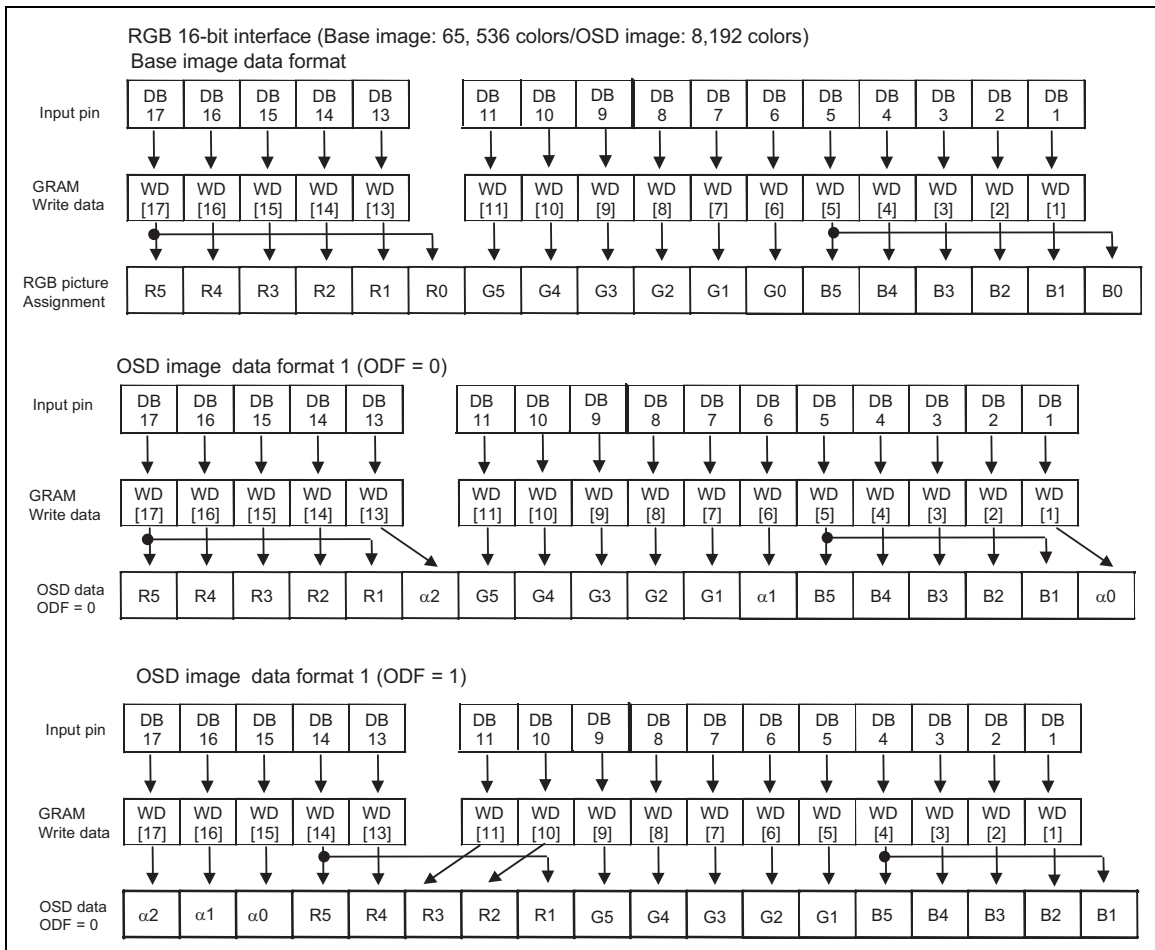

RGB 16-bit interface (Base/OSD image display)

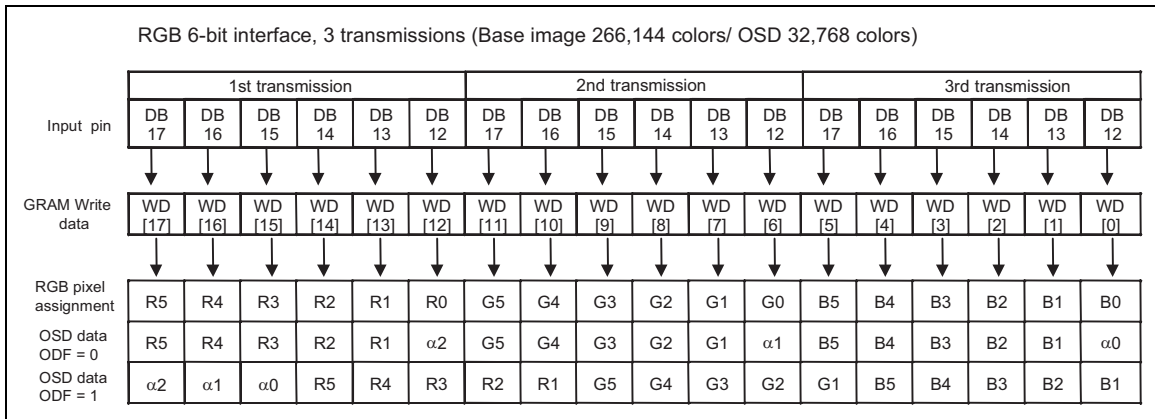

RGB 6-bit interface (Base/OSD image)

Table 49 GRAM data and LCD output level (REV = 0)

GRAM data RGB	Selected grayscale level		GRAM data RGB	Selected grayscale level	
	Positive	Negative		Positive	Negative
6'h00	V0	V63	6'h20	V32	V31
6'h01	V1	V62	6'h21	V33	V30
6'h02	V2	V61	6'h22	V34	V29
6'h03	V3	V60	6'h23	V35	V28
6'h04	V4	V59	6'h24	V36	V27
6'h05	V5	V58	6'h25	V37	V26
6'h06	V6	V57	6'h26	V38	V25
6'h07	V7	V56	6'h27	V39	V24
6'h08	V8	V55	6'h28	V40	V23
6'h09	V9	V54	6'h29	V41	V22
6'h0A	V10	V53	6'h2A	V42	V21
6'h0B	V11	V52	6'h2B	V43	V20
6'h0C	V12	V51	6'h2C	V44	V19
6'h0D	V13	V50	6'h2D	V45	V18
6'h0E	V14	V49	6'h2E	V46	V17
6'h0F	V15	V48	6'h2F	V47	V16
6'h10	V16	V47	6'h30	V48	V15
6'h11	V17	V46	6'h31	V49	V14
6'h12	V18	V45	6'h32	V50	V13
6'h13	V19	V44	6'h33	V51	V12
6'h14	V20	V43	6'h34	V52	V11
6'h15	V21	V42	6'h35	V53	V10
6'h16	V22	V41	6'h36	V54	V9
6'h17	V23	V40	6'h37	V55	V8
6'h18	V24	V39	6'h38	V56	V7
6'h19	V25	V38	6'h39	V57	V6
6'h1A	V26	V37	6'h3A	V58	V5
6'h1B	V27	V36	6'h3B	V59	V4
6'h1C	V28	V35	6'h3C	V60	V3
6'h1D	V29	V34	6'h3D	V61	V2
6'h1E	V30	V33	6'h3E	V62	V1
6'h1F	V31	V32	6'h3F	V63	V0

RAM Access through RGB-I/F and System I/F

The HD66781 writes all display data to the internal RAM even in the RGB-I/F mode. Through the RGB-I/F mode, only the data for the moving picture area as well as for the frames to update screens can be transmitted. By writing data in the high-speed write mode (HWM = 1) and with the window address function, the HD66781 achieves high-speed access to RAM with low power consumption while displaying moving pictures. In the frames other than the moving picture screen update, the display data in the area other than the moving picture area can be updated through a system interface.

RAM access is also possible through the system interface even in the RGB-I/F mode. In the RGB interface mode, data are written to RAM in synchronization with the DOTCLK input during ENABLE = "Low". When writing data in the RGB-I/F mode through the system interface, it is necessary to set ENABLE "High" to stop writing through the RGB interface. After accessing RAM through the system interface, wait an enough time for the write/read bus cycle before starting RAM access through the RGB interface.

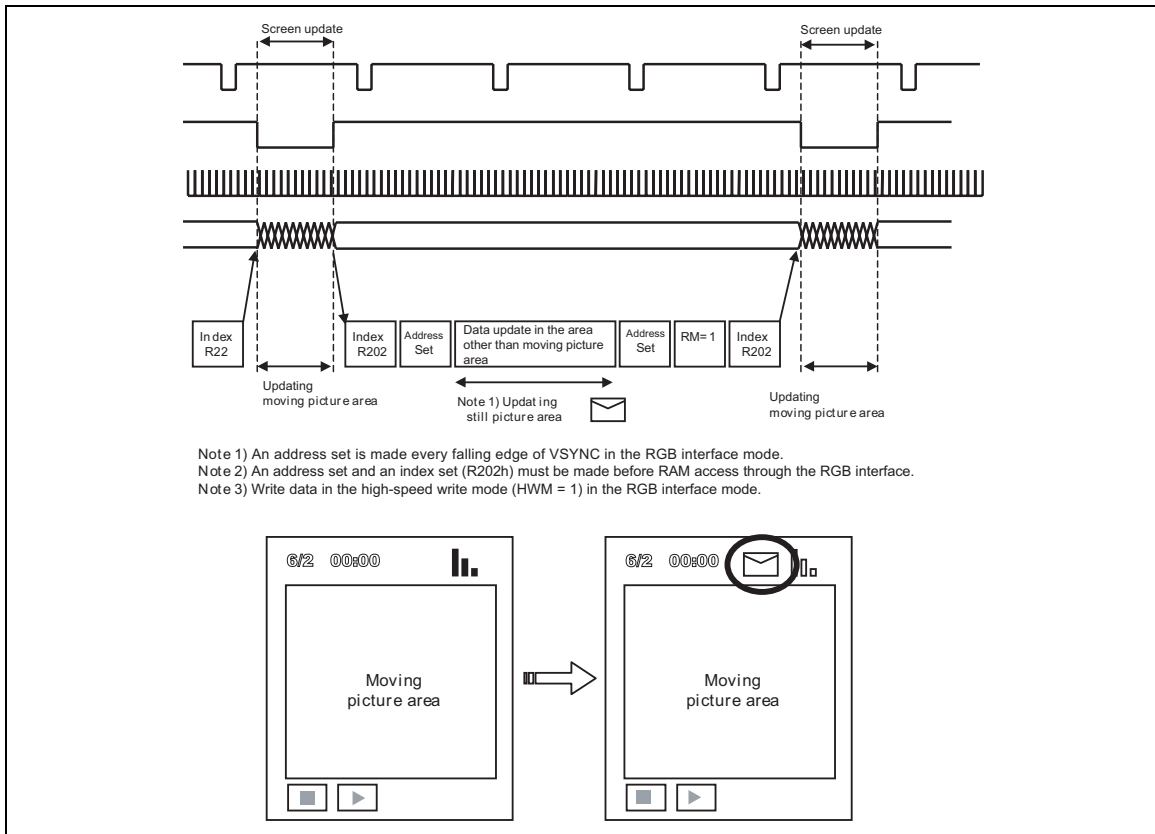

Updating still picture area while displaying a moving picture

Read Data from GRAM (R202h)

R/W RS

R	1	RAM read data (RD[17:0]) are assigned differently to the DB[17:0] pins according to an interface .
---	---	--

RD[17:0]: Read 18-bit data from GRAM. The RAM read data (RD[17:0]) are assigned differently to the DB[17:0] pins according to an interface.

When data are read out from GRAM to the microcomputer, the first-word data read immediately after the GRAM address set are latched in the internal read-data latch, and the data in the data bus (DB17-0) are nullified. The data are read as valid data from the second word.

When the 8-/16-bit interfaces are selected, the GRAM data in the LSBs of R and B pixels are not read out. When reading out OSD data, it takes the data format when ODF = 0. This function is not available in the RGB interface mode. Set TRI = 0 while data read is executed.

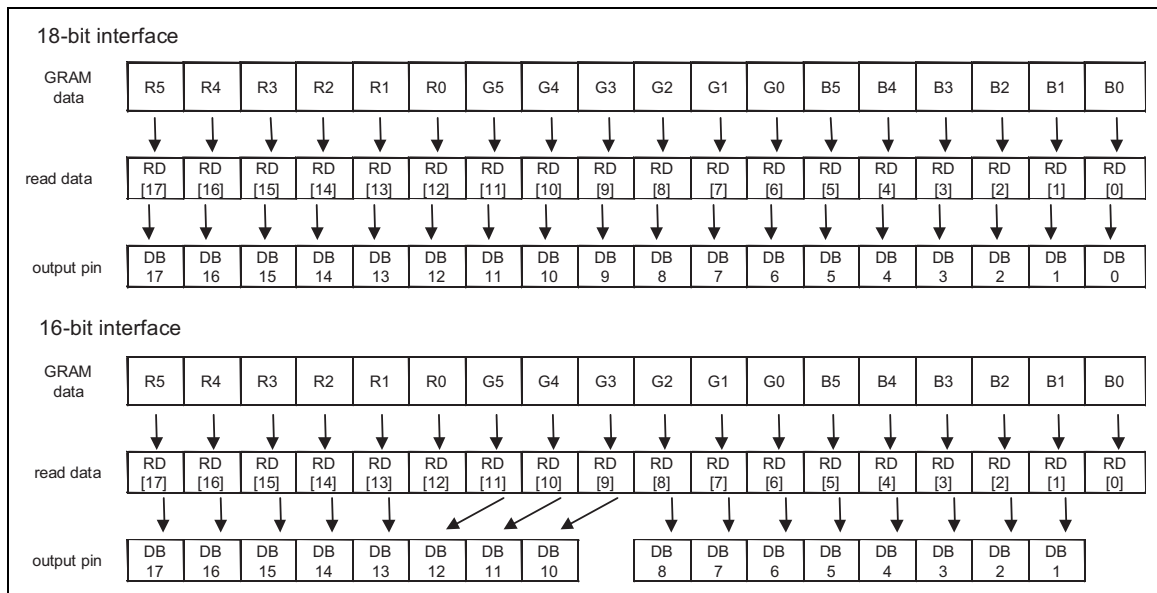

Read data from GRAM: 18/16-bit interface

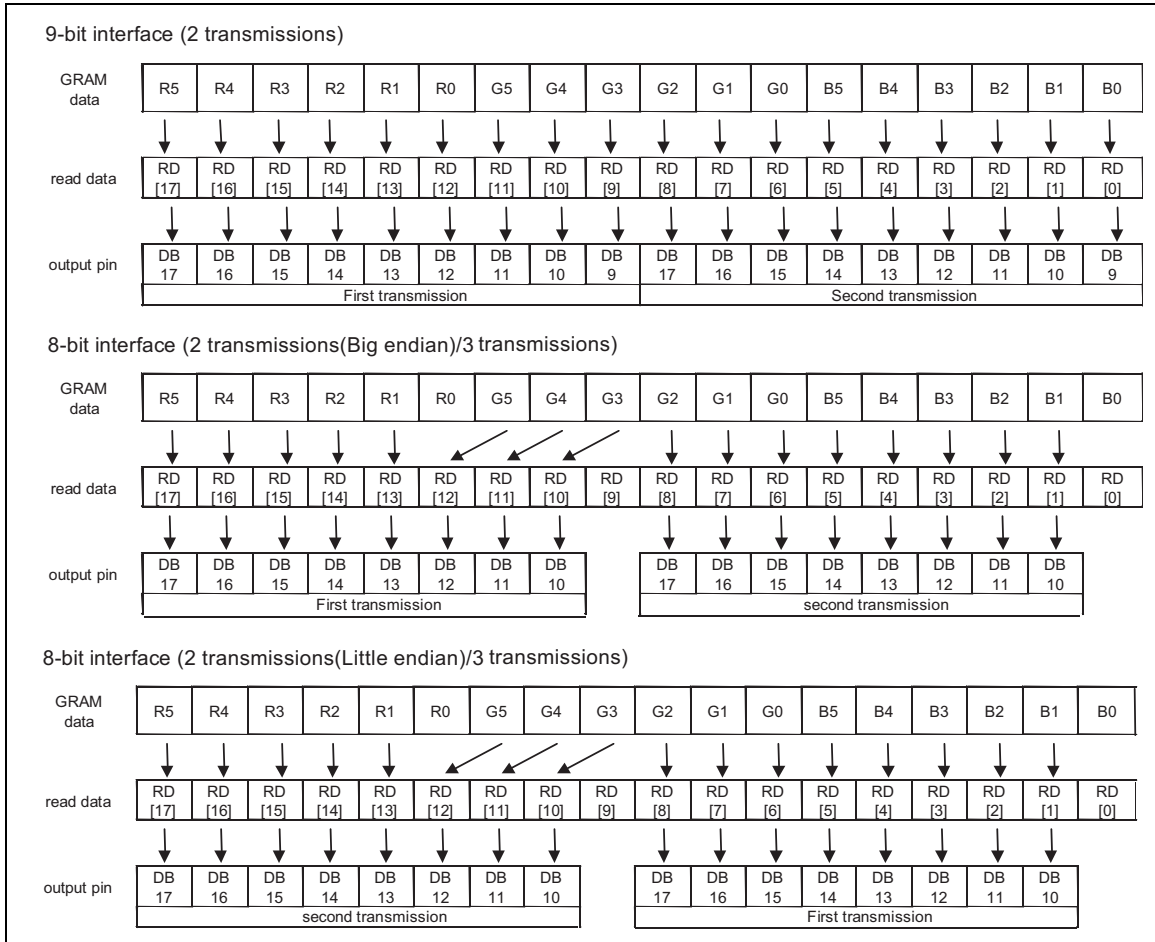

Read data from GRAM: 9/8-bit interface

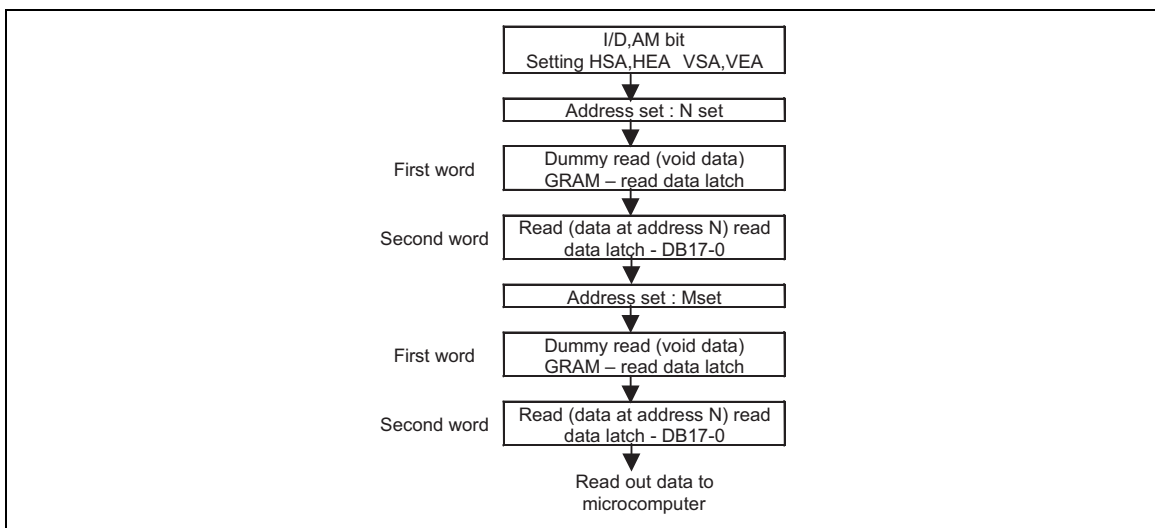

GRAM read sequence

RAM Write Data Mask 1/2 (R203h/R204h)

R/W	RS	IB15	IB14	IB13	IB12	IB11	IB10	IB9	IB8	IB7	IB6	IB5	IB4	IB3	IB2	IB1	IB0
W	1	0	0	WM [11]	WM [10]	WM [9]	WM [8]	WM [7]	WM [6]	0	0	WM [5]	WM [4]	WM [3]	WM [2]	WM [1]	WM [0]
W	1	0	0	0	0	0	0	0	0	0	0	WM [17]	WM [16]	WM [15]	WM [14]	WM [13]	WM [12]

Note 1) Top R203, bottom R204

WM[17:0]: Write-mask data by bit when the data are written to GRAM. For example, if WM17 = 1, the WM17 write-mask the MSB of the data to write to GRAM so that the data in the MSB is not written to GRAM. The rest of WM16 ~ 0 bits also write-mask the data in the corresponding bits of GRAM write data as well when they are set to 1.

The WM17-0 bits write-mask the 18-bit data to write to GRAM.

Note 1) This function is not available in the RGB-I/F mode.

Note 2) OSD image data are written to RAM in the ODF = 0 format. The write-mask setting for OSD images must be made for the ODF = 0 format.

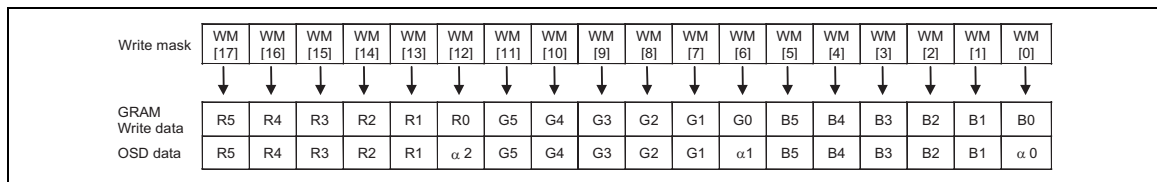

RAM write data mask

Window Address Control Instructions

Window horizontal RAM address Start/End (R210h/ R211h)

Window vertical RAM address Start/End (R212h/R213h)

	R/W	RS	IB15	IB14	IB13	IB12	IB11	IB10	IB9	IB8	IB7	IB6	IB5	IB4	IB3	IB2	IB1	IB0
R50	W	1	0	0	0	0	0	0	0	0	HSA [7]	HSA [6]	HSA [5]	HSA [4]	HSA [3]	HSA [2]	HSA [1]	HSA [0]
R51	W	1	0	0	0	0	0	0	0	0	HEA [7]	HEA [6]	HEA [5]	HEA [4]	HEA [3]	HEA [2]	HEA [1]	HEA [0]
R52	W	1	0	0	0	0	0	0	0	VSA [8]	VSA [7]	VSA [6]	VSA [5]	VSA [4]	VSA [3]	VSA [2]	VSA [1]	VSA [0]
R53	W	1	0	0	0	0	0	0	0	VEA [8]	VEA [7]	VEA [6]	VEA [5]	VEA [4]	VEA [3]	VEA [2]	VEA [1]	VEA [0]

HSA[7:0] Specify the start position of a window-address range in the horizontal direction by address.

HEA[7:0] Specify the end position of a window-address range in the horizontal direction by address. Data are written to a rectangular area within GRAM from the address specified by HSA to the address specified by HEA. The setting of the address is required before writing data to RAM. Make sure the address is set to satisfy $8'h00 \leq HSA < HEA \leq 8'hEF$ and $8'h4 \leq HEA - HSA$.

VSA[7:0] Specify the start position of a window-address range in the vertical direction to access to RAM.

VEA[7:0] Specify the end position of a window-address range in the vertical direction to access to RAM. Data are written to a rectangular area within GRAM from the address specified by VSA to the address specified by VEA. The setting of addresses is required before writing data to RAM. Make sure the addresses are set to satisfy $9'h000 \leq VSA < VEA \leq 9'h19F$.

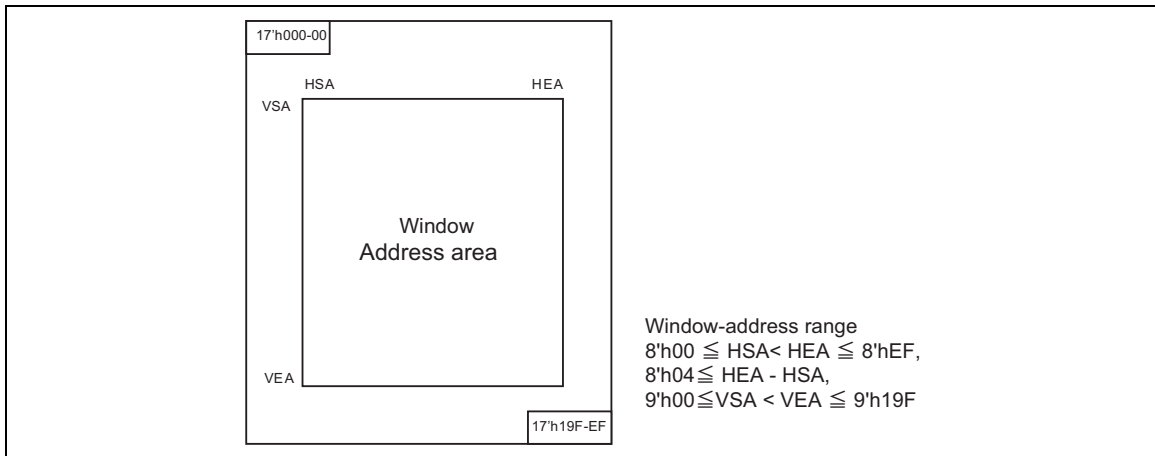

GRAM address map and window-address range

Note 1) Set a window-address range within the GRAM address map.

Note 2) In the high-speed write mode, data are written to GRAM by one horizontal line. Write data to GRAM by horizontal line unit.

Note 3) Make an address set within the window address area. In the high-speed write mode, make an address set from the first line of the window address area.

γ Control (R300h ~ R309h)

	R/W	RS	IB15	IB14	IB13	IB12	IB11	IB10	IB9	IB8	IB7	IB6	IB5	IB4	IB3	IB2	IB1	IB0	
R300	W	1	0	0	0	0	0	PK P1[2]	PK P1[1]	PK P1[0]	0	0	0	0	0	PK P0[2]	PK P0[1]	PK P0[0]	
R301	W	1	0	0	0	0	0	PK P3[2]	PK P3[1]	PK P3[0]	0	0	0	0	0	PK P2[2]	PK P2[1]	PK P2[0]	
R302	W	1	0	0	0	0	0	PK P5[2]	PK P5[1]	PK P5[0]	0	0	0	0	0	PK P4[2]	PK P4[1]	PK P4[0]	
R303	W	1	0	0	0	0	0	PR P1[2]	PR P1[1]	PR P1[0]	0	0	0	0	0	PR P0[2]	PR P0[1]	PR P0[0]	
R304	W	1	0	0	0	VR P1[4]	VR P1[3]	VR P1[2]	VR P1[1]	VR P1[0]	0	0	0	0	0	VR P0[3]	VR P0[2]	VR P0[1]	VR P0[0]
R305	W	1	0	0	0	0	0	PK N1[2]	PK N1[1]	PK N1[0]	0	0	0	0	0	PK P0[2]	PK P0[1]	PK P0[0]	
R306	W	1	0	0	0	0	0	PK N3[2]	PK N3[1]	PK N3[0]	0	0	0	0	0	PK N2[2]	PK N2[1]	PK N2[0]	
R307	W	1	0	0	0	0	0	PK N5[2]	PK N5[1]	PK N5[0]	0	0	0	0	0	PK N4[2]	PK N4[1]	PK N4[0]	
R308	W	1	0	0	0	0	0	PR N1[2]	PR N1[1]	PR N1[0]	0	0	0	0	0	PR N0[2]	PR N0[1]	PR N0[0]	
R309	W	1	0	0	0	VR N1[4]	VR N1[3]	VR N1[2]	VR N1[1]	VR N1[0]	0	0	0	0	0	VR N0[3]	VR N0[2]	VR N0[1]	VR N0[0]

- PKP5-0[2:0]:** γ fine adjustment registers for positive polarity
- PRP1-0[2:0]:** γ gradient adjustment registers for positive polarity
- VRP(N)0[3:0]:** amplitude adjustment resistor for positive polarity
- PKN5-0[2:0]:** γ fine adjustment registers for negative polarity
- PRN1-0[2:0]:** γ gradient adjustment registers for negative polarity
- VRP(N)1[4:0]:** amplitude average adjustment resistor for negative polarity

Base image display control instructions**Number of Line (R400h)****Base image display position (R401h)****Base picture RAM Address (R402h)****Base picture RAM Address (R403h)****Vertical scroll Control (R404h)****Base image expansion area/start line address (R405h)****Base image expansion area/end line address (R406h)**

	R/W	RS	IB15	IB14	IB13	IB12	IB11	IB10	IB9	IB8	IB7	IB6	IB5	IB4	IB3	IB2	IB1	IB0
R400	W	1	0	0	0	0	0	0	0	0	0	0	NL1 [5]	NL1 [4]	NL1 [3]	NL1 [2]	NL1 [1]	NL1 [0]
R401	W	1	0	0	0	0	0	0	0	0	0	0	0	0	0	0	VLE	REV
R402	W	1	0	0	0	0	0	0	0	BSA [8]	BSA [7]	BSA [6]	BSA [5]	BSA [4]	BSA [3]	BSA [2]	BSA [1]	BSA [0]
R403	W	1	0	0	0	0	0	0	0	BEA [8]	BEA [7]	BEA [6]	BEA [5]	BEA [4]	BEA [3]	BEA [2]	BEA [1]	BEA [0]
R404	W	1	0	0	0	0	0	0	0	VL [8]	VL [7]	VL [6]	VL [5]	VL [4]	VL [3]	VL [2]	VL [1]	VL [0]
R405	W	1	0	0	0	0	0	0	0	ESA [8]	ESA [7]	ESA [6]	ESA [5]	ESA [4]	ESA [3]	ESA [2]	ESA [1]	ESA [0]
R406	W	1	0	0	0	0	0	0	0	EEA [8]	EEA [7]	EEA [6]	EEA [5]	EEA [4]	EEA [3]	EEA [2]	EEA [1]	EEA [0]

Base image control instructions

NL0[5:0]: Set the number of liquid crystal drive raster-rows. The number of raster-rows can be set to 8 multiples. The GRAM address mapping is made irrespective of the value set for the number of raster-rows to drive liquid crystal. The value should be set equal to or more than to drive the number of raster-rows required for the panel size.

REV: When REV = 1, a reverse display is shown within the display area. The grayscale level inversion enables to use same data to display on both normally white and normally black panels. The REV setting is effective for both OSD and base image areas.

The source outputs during front and back porches and a blank period during partial display mode depend on the setting of PTS bits.

Table 50

REV0	GRAM data	Source output level in display area	
		Positive polarity	Negative polarity
0	18'h00000	V63	V0
	⋮	⋮	⋮
	18'h3FFFF	V0	V63
1	18'h00000	V0	V63
	⋮	⋮	⋮
	18'h3FFFF	V63	V0

Note 1) The source outputs during front and back porches and a blank period during partial display mode depend on the setting of PTS bits.

VLE: When VLE = 1, settings for the vertical scroll display is made valid. The start line is displayed according to the VL[8:0] setting. The raster-rows that display a base image are scrolled by the number of lines set by VL bits. OSD area is not affected by the base-picture scrolling. This function is not available while external display interface is selected. While external display interface is selected, make sure that VLE= 0.

Table 51

VLE	Base image
0	Fixed display
1	Scrolling display

Note 1) Scroll function is not available during the interlaced drive (FLD = 2'h3)

BSA[8:0]/BEA[8:0]: Set the start line address (BSA) and the end line address (BEA) of the base image display RAM area.

Display RAM data from the one set at BSA bits from the first line. Make sure that base image display RAM area (BSA/BEA) is equal to or more than the number of raster-rows driving a panel ($NL \leq BSA - BEA$). In case of $BSA - BEA \leq NL$, outside the base image area becomes non-lit display.

VL[8:0] Set the number of raster-rows that are scrolled for a base image. The numbers of raster-rows set by VL bits are scrolled within the base image.

ESA[8:0]/EEA[8:0] Set the start line address (ESA) and the end line address (EEA) of the area which is magnified in the base image display RAM area.

A base image in the area specified with ESA and EEA is magnified on display. Make sure that $BSA \leq ESA \leq EEA \leq BEA$. A magnified base image is not available with the scrolling function.

Table 52 Liquid crystal drive raster-rows

NL[5:0]	Number of raster-rows	NL[5:0]	Number of raster-rows
6'h00	Setting disabled	6'h14	168
6'h01	16	6'h15	176
6'h02	24	6'h16	184
6'h03	32	6'h17	192
6'h04	40	6'h18	200
6'h05	48	6'h19	208
6'h06	56	6'h1A	216
6'h07	64	6'h1B	224
6'h08	72	6'h1C	232
6'h09	80	6'h1D	240
6'h0A	88	6'h1E	248
6'h0B	96	6'h1F	256
6'h0C	104	6'h20	264
6'h0D	112	6'h21	272
6'h0E	120	6'h22	280
6'h0F	128	6'h23	288
6'h10	136	6'h24	296
6'h11	144	6'h25	304
6'h12	152	6'h26	312
6'h13	160	6'h27	320

OSD control instructions

OSD image 1 display position (R500h)

OSD image 1 RAM Address /Start line Address (R501h)

OSD image 1 RAM Address /End line Address (R502h)

OSD image 2 display position (R503h)

OSD image 2 RAM Address/Start line Address (R504h)

OSD image 2 RAM Address/End line Address (R505h)

OSD image 3 display position (R506h)

OSD image 3 RAM Address/Start line Address (R507h)

OSD image 3 RAM Address/End line Address (R508h)

	R/W	RS	IB15	IB14	IB13	IB12	IB11	IB10	IB9	IB8	IB7	IB6	IB5	IB4	IB3	IB2	IB1	IB0
R500	W	1	0	0	0	0	0	0	0	ODP0 0 [8]	ODP1 0 [7]	ODP2 0 [6]	ODP3 0 [5]	ODP4 0 [4]	ODP5 0 [3]	ODP6 0 [2]	ODP7 0 [1]	ODP8 0 [0]
R501	W	1	0	0	0	0	0	0	0	OSA0 0 [8]	OSA1 0 [7]	OSA2 0 [6]	OSA3 0 [5]	OSA4 0 [4]	OSA5 0 [3]	OSA6 0 [2]	OSA7 0 [1]	OSA8 0 [0]
R502	W	1	0	0	0	0	0	0	0	OEA0 0 [8]	OEA1 0 [7]	OEA2 0 [6]	OEA3 0 [5]	OEA4 0 [4]	OEA5 0 [3]	OEA6 0 [2]	OEA7 0 [1]	OEA8 0 [0]
R503	W	1	0	0	0	0	0	0	0	ODP1 1 [8]	ODP2 1 [7]	ODP3 1 [6]	ODP4 1 [5]	ODP5 1 [4]	ODP6 1 [3]	ODP7 1 [2]	ODP8 1 [1]	ODP9 1 [0]
R504	W	1	0	0	0	0	0	0	0	OSA1 1 [8]	OSA2 1 [7]	OSA3 1 [6]	OSA4 1 [5]	OSA5 1 [4]	OSA6 1 [3]	OSA7 1 [2]	OSA8 1 [1]	OSA9 1 [0]
R505	W	1	0	0	0	0	0	0	0	OEA1 1 [8]	OEA2 1 [7]	OEA3 1 [6]	OEA4 1 [5]	OEA5 1 [4]	OEA6 1 [3]	OEA7 1 [2]	OEA8 1 [1]	OEA9 1 [0]
R506	W	1	0	0	0	0	0	0	0	ODP2 2 [8]	ODP3 2 [7]	ODP4 2 [6]	ODP5 2 [5]	ODP6 2 [4]	ODP7 2 [3]	ODP8 2 [2]	ODP9 2 [1]	ODP10 2 [0]
R507	W	1	0	0	0	0	0	0	0	OSA2 2 [8]	OSA3 2 [7]	OSA4 2 [6]	OSA5 2 [5]	OSA6 2 [4]	OSA7 2 [3]	OSA8 2 [2]	OSA9 2 [1]	OSA10 2 [0]
R508	W	1	0	0	0	0	0	0	0	OEA2 2 [8]	OEA3 2 [7]	OEA4 2 [6]	OEA5 2 [5]	OEA6 2 [4]	OEA7 2 [3]	OEA8 2 [2]	OEA9 2 [1]	OEA10 2 [0]

ODP0[8:0]: ODP0 : Set the display position of OSD image 1.

ODP1[8:0]: ODP1 : Set the display position of OSD image 2.

ODP2[8:0]: ODP2 : Set the display position of OSD image 3.

The display areas for OSD images 1, 2, 3 should not overlap one another. Set each area as follows.

Display area of OSD image 1: ODP0, ODP0+(OEA0 – OSA0)

Display area of OSD image 2: ODP1, ODP1+(OEA1 – OSA1)

Display area of OSD image 3: ODP2, ODP2+(OEA2 – OSA2)

Make sure that

display area of OSD image 1 < Display area of OSD image 2 < Display area of OSD image 3.

If ODP0 is set “9’h000”, OSD image 1 is displayed from the start line of the base image on the first panel.

The OSD is not available during interlaced drive (FLD = 2’h3).

OSA0[8:0] OEA0[8:0]: OSA0, OEA0 : Set the start line address and end line address for display RAM area of the OSD image 1.

OSA1[8:0] OEA1[8:0]: OSA1, OEA1 : Set the start line address and end line address for display RAM area of the OSD image 2.

OSA2[8:0] OEA2[8:0]: OSA2, OEA2 : Set the start line address and end line address for display RAM area of the OSD image 3.

HD66783 Instruction Table

IDX[2]	IDX[1]	IDX[0]	TB[12]	TB[11]	TB[10]	TB[9]	TB[8]	TB[7]	TB[6]	TB[5]	TB[4]	TB[3]	TB[2]	TB[1]	TB[0]
0	0	0	0	GON	VCOMG	BT[2]	BT[1]	BT[0]	DC[2]	DC[1]	DC[0]	AP[2]	AP[1]	AP[0]	0
0	0	1	0	DK	1	EOM	0	PCN	VRH[3]	VRH[2]	VRH[1]	VRH[0]	VC[2]	VC[1]	VC[0]
0	1	0	DC[12]	DC[11]	DC[10]	VDV[4]	VDV[3]	VDV[2]	VDV[1]	VDV[0]	VCM[4]	VCM[3]	VCM[2]	VCM[1]	VCM[0]
0	1	1	Setting Disabled												
1	0	0	Setting Disabled												
1	0	1	Setting Disabled												
1	1	0	GS	NL[5]	NL[4]	NL[3]	NL[2]	NL[1]	NL[0]	SCN[5]	SCN[4]	SCN[3]	SCN[2]	SCN[1]	SCN[0]
1	1	1	0	0	0	0	0	0	0	0	0	0	0	FLD[1]	FLD[0]

HD667P21 Instruction Table

IDX[2]	IDX[1]	IDX[0]	TB[12]	TB[11]	TB[10]	TB[9]	TB[8]	TB[7]	TB[6]	TB[5]	TB[4]	TB[3]	TB[2]	TB[1]	TB[0]
0	0	0	0	GON	VCOMG	BT[2]	BT[1]	BT[0]	DC[2]	DC[1]	DC[0]	AP[2]	AP[1]	AP[0]	0
0	0	1	0	0	0	0	0	PCN	VRH[3]	VRH[2]	VRH[1]	VRH[0]	VC[2]	VC[1]	VC[0]
0	0	1	0	1	0	DK[1]	DK[0]	0	0	0	0	0	0	0	0
0	1	0	0	0	0	VDV[4]	VDV[3]	VDV[2]	VDV[1]	VDV[0]	VCM[4]	VCM[3]	VCM[2]	VCM[1]	VCM[0]
0	1	1	Setting Disabled												
1	0	0	Setting Disabled												
1	0	1	Setting Disabled												
1	1	0	Setting Disabled												
1	1	1	0	0	VGL[4]	VGL[3]	VGL[2]	VGL[1]	VGL[0]	0	VGH[4]	VGH[3]	VGH[2]	VGH[1]	VGH[0]

AP and NL require a same and separate setting for each HD66781 and the register to transfer (Different Setting Disabled).

1. Setting for AP register of 781
2. Setting for AP register of 783/7P21 (R111h, TB[3]-[1])
3. Serial Transfer to 783/7P21 (IDX000)

1. Setting for NL register of 781
2. Setting for NL register of 783 (R111h TB[11]-[6])
3. Serial Transfer to 783 (IDX110)

1. Setting for FLD register of 781
2. Setting for FLD register of 783 (R111h TB[1]-[0])
3. Serial Transfer to 783 (IDX111)

Reset Function

The HD66781 is internally initialized by RESET input. During the reset period, internal settings are initialized. No access to instructions or GRAM data from the MPU is accepted during the reset period. The gate driver and the power supply are also automatically initialized when RESET input enters into the HD66781. The RESET period must be secured for at least 1 ms. In case of resetting by turning on the power supply (power-on reset), wait until the R-C oscillation frequency becomes stable after power is supplied (10 ms). During this period, do not access GRAM or make any initial instruction setting.

Instruction Set Initialization

See the parenthesis number in each bit in the instruction list for the initial value.

RAM Data Initialization

The RAM data are not automatically initialized by RESET input and must be initialized by software during the display-off period (D1-0 = 00).

Output Pin Initialization

- | | |
|--|---|
| 1. LCD driver output pins (source outputs) | : Output GND level (All pins) |
| 2. Vcom | : Halt (Output GND) |
| 3. Gate driver control signal | : Halt (Output GND) |
| | (FLM1, FLM2, CL11/SFTCLK11,
CL12/SFTCLK12, SFTCLK21, SFTCLK22,
M1, M2, DISPTMG1, DISPTMG2, EQ1, EQ2,
DCCLK1, DCCLK2) |
| 4. Gate driver serial interface | : Halt GCS, GCL, GDA (Vcc1 output) |
| 5. Oscillator output pin | : Oscillate |
| 6. Synchronizing signal (BST) | : Output GND |
| 7. RESET signal output | : Same polarity with the RESET* input |

RAM Address and Display Position on the Panel

The HD66781 incorporates a memory for 240RGB x 416-line display, and enables to drive QVGA-size panel (240RGB x 320 lines). Unused display memory is available for a partial OSD area. These features realize various ways of display with a single chip.

The HD66781 allows independent settings for the display panel and the drive position, where the RAM area of each image is specified in relation to the display panel that is assigned to gate pins to fit into the assembly. Accordingly, in designing a panel, it is not necessary to take the assembly position into account.

The HD66781 allows realizes various ways of display with the following settings:

1. Specify the RAM area of a base image (BSA, BEA)
2. Specify the RAM area of an OSD image (OSA_x, OEA_x)
3. Specify the display position of the OSD image (step 2) on the panel (ODP_x).
4. Specify the gate pins for driving the panel displaying a base image (SCN, NL) and the scan order (GS).
5. Execute display ENABLE (BASEE, OSDE0/1/2) for each image after turning on display.

A base image is a display that is set to be a basic display on each panel. An OSD image is a picture that is set to display on the base image. The panel-drive settings are made with gate scan starting position (SCN), the number of raster-rows to drive (NL), and scan direction (GS). The gate scan direction can be set differently for each panel to fit into the assembly. To change the display position horizontally, the setting of SS bit is required during RAM write.

Table 53

	Display ENABLE	Numbers of lines	RAM area
(Base image 1)	BASEE	NL	(BSA, BEA)

Note 1) The base image is displayed from the start line of each panel.

Note 2) Make sure that base image RAM area is $NL \leq BEA - BSA$.

Table 54

	Display ENABLE	Display position	RAM area
OSD image 1	OSDE0	ODP0	(OSA0, OEA0)
OSD image 2	OSDE1	ODP1	(OSA1, OEA1)
OSD image 3	OSDE2	ODP2	(OSA2, OEA2)

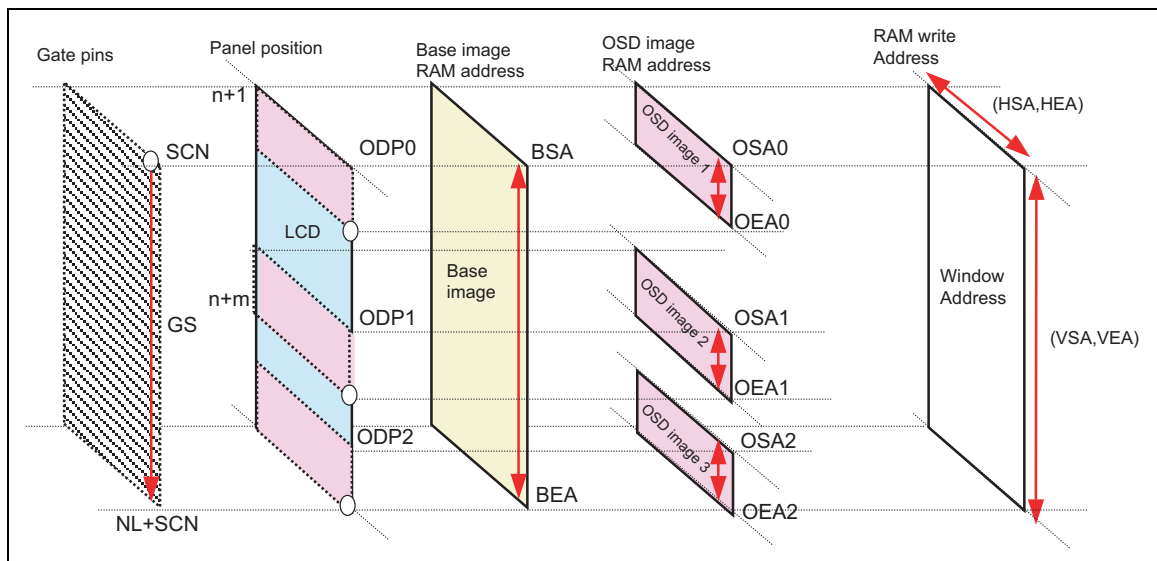

RAM Address, display position and drive position

Notes to the setting of panel control registers

The HD66781 has some constraints in setting the coordinate with regard to the display data, position, and OSD.

Screen settings

The following equation must be observed in making a setting for the screen.

$$\begin{aligned} NL &\leq 320 \text{ lines} \\ 0 &\leq SCN < SCN + NL \leq 320 \text{ lines} \end{aligned}$$

Base image display

Base image is displayed from the first line of each panel. Base image display start position: $SCN = BSA$

Set the base image RAM area (BSA, BEA) equal to or more than the number of lines (NL) required driving a panel. $NL \leq BEA - BSA$

OSD image display

Set the OSD image RAM area (OSA_x, OEA_x) not to overlap one another. Set the OSD positions not to overlap one another.

$$\begin{aligned} 0 &\leq ODP0 \leq ODP0 + n \times (OEA0 - OSA0 + 1) - 1 < \\ ODP1 &\leq ODP1 + n \times (OEA1 - OSA1 + 1) - 1 < \\ ODP2 &\leq ODP2 + n \times (OEA2 - OSA2 + 1) - 1 \leq NL \end{aligned}$$

n: OSD image magnification scale

The OSD images are displayed 100% when base image is turned off (BASEE = 0). The arrangement of α channels is also changed when changing RGB order to BGR. The OSD data are read out in the format when ODF is set to 0. During interlaced drive (FLD = 2'h3), OSD and α blending functions are not available.

Following figure shows the relationship among RAM address, display position, and panel drive.

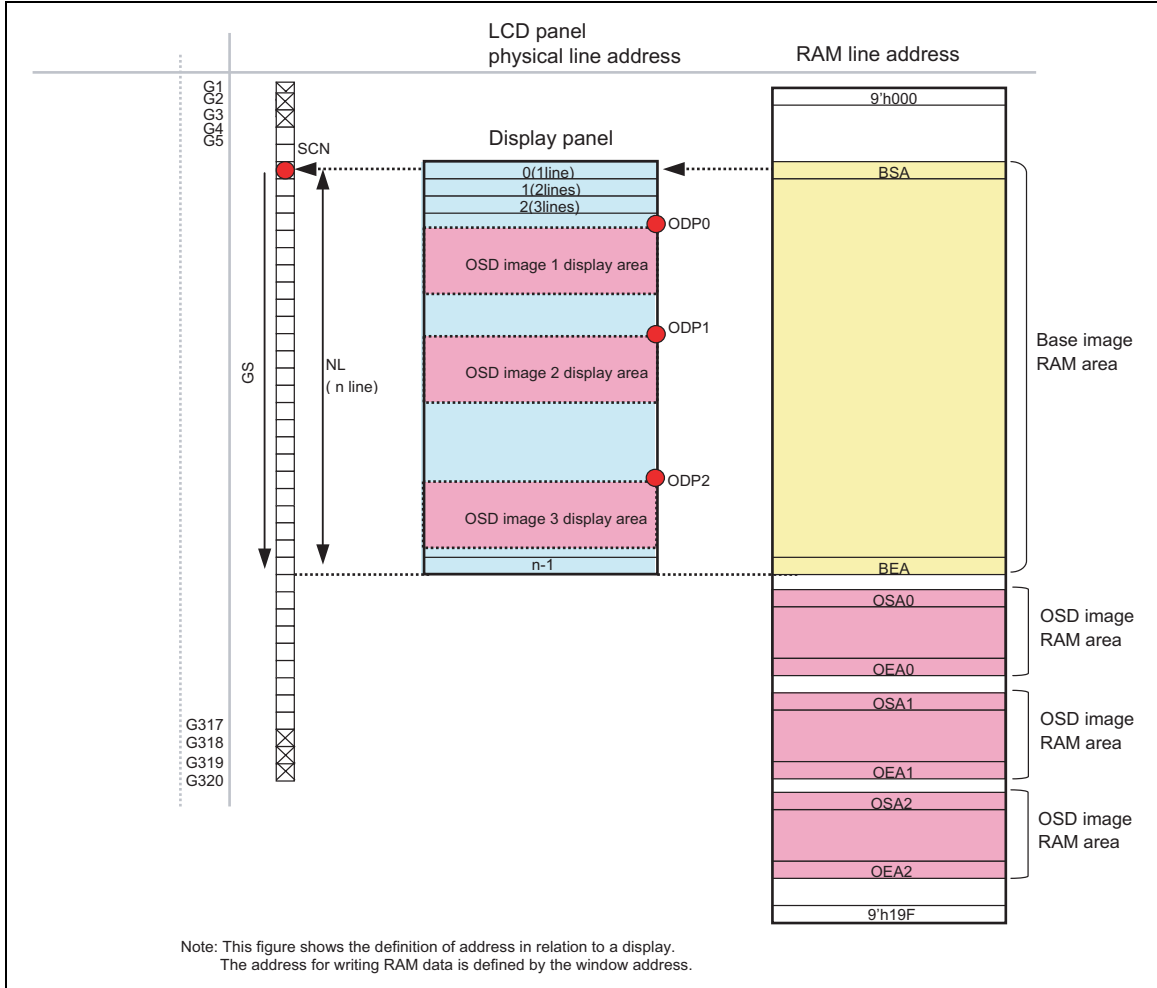

Display RAM address and panel display position

OSD and α blending functions

The HD66781 incorporates OSD and α blending functions. The OSD image data has 3 α bits to select transmission rates among 0, 25, 50, 75, 100%. The HD66781 not only handles 32,678-color OSD at maximum but also enables picture display data as OSD, in addition to usual single color text display. The HD66781 realizes various ways of display with a single-chip configuration.

The HD66781 eliminates the processing of OSD and α blending from the microcomputer. Just transmitting OSD image data including α bits into the LCD driver as usual enables OSD and α blending display.

OSD and α blending processing

The HD66781 writes data to RAM as an OSD image according to the setting of OSD bit. An image read out as OSD according to the OSD image display setting is displayed after being processed according to the transmission rate set by α bits. OSD and α blending settings can be made by pixels (RGB).

Table 55

$\alpha 2$	$\alpha 1$	$\alpha 0$	Transmission rate	Picture processing (Display data)	Picture processing (Display data)
0	0	0	0%	Base image display	Base image x 1.0 + OSD image x 0
0	0	1	-	Setting disabled	-
0	1	0	25%	Base image (75%) + OSD image (25%) display	25% transmission
0	1	1	75%	Base image (25%) + OSD image (75%) display	75% transmission
1	0	0	50%	Base image (50%) + OSD image (50%) display	Base image x 0.5 + OSD image x 0.5
1	0	1	-	Setting disabled	-
1	1	0	100%	OSD image display	Base image x 0 + OSD image x 1.0
1	1	1	-	Setting disabled	-

Note 1) The OSD image is displayed 100% when base image is turned off (BASEE = 0).

OSD and α blending processing

The following is an example of display with OSD and α blending functions with the HD66781. In the following example, the unused RAM area, which is not used for base image display, is used for OSD and α blending RAM area.

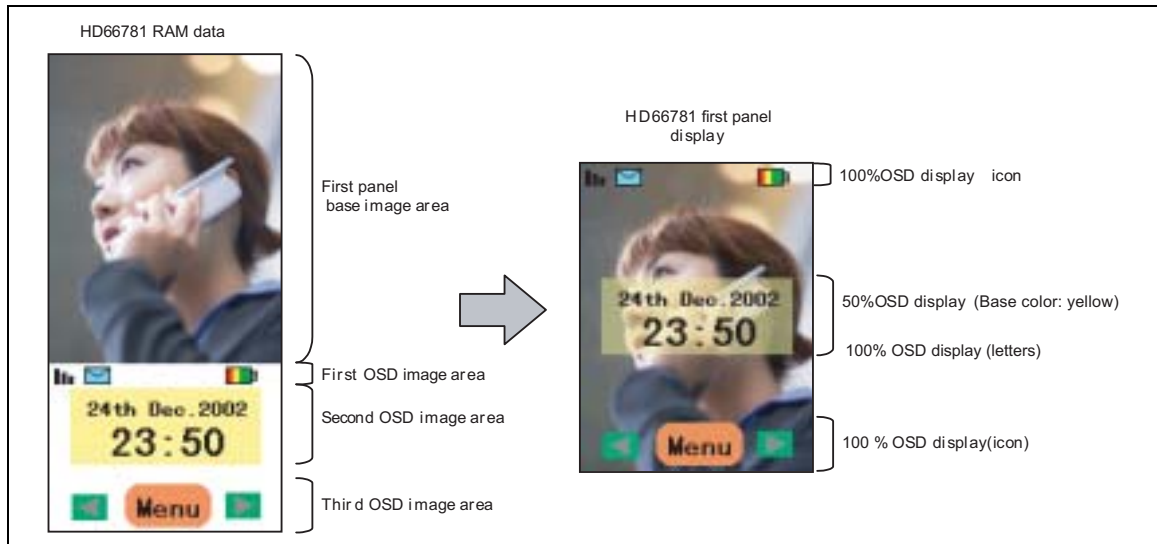

Display with OSD and α blending

OSD image data format

OSD image data format (α bit arrangement) is changeable with ODF bits. Select an appropriate format for the system to process. When writing an OSD image to RAM, set OSD to 1 beforehand. Specify the RAM write area by the window address.

OSD image data format

ODF	D 17	D 16	D 15	D 14	D 13	D 12	D 11	D 10	D9	D8	D7	D6	D5	D4	D3	D2	D1	D0
0	R5	R4	R3	R2	R1	2	G5	G4	G3	G2	G1	1	B5	B4	B3	B2	B1	0
1	2	1	0	R4	R3	R2	R1	R0	G4	G3	G2	G1	G0	B4	B3	B2	B1	B0
Normal data	R5	R4	R3	R2	R1	R0	G5	G4	G3	G2	G1	G0	B5	B4	B3	B2	B1	B0

OSD image display setting

To make a setting for OSD image display,

1. Specify OSD RAM area (OSA, OEA)
2. Specify OSD position
3. Set OSD ENABLE (OSDE)

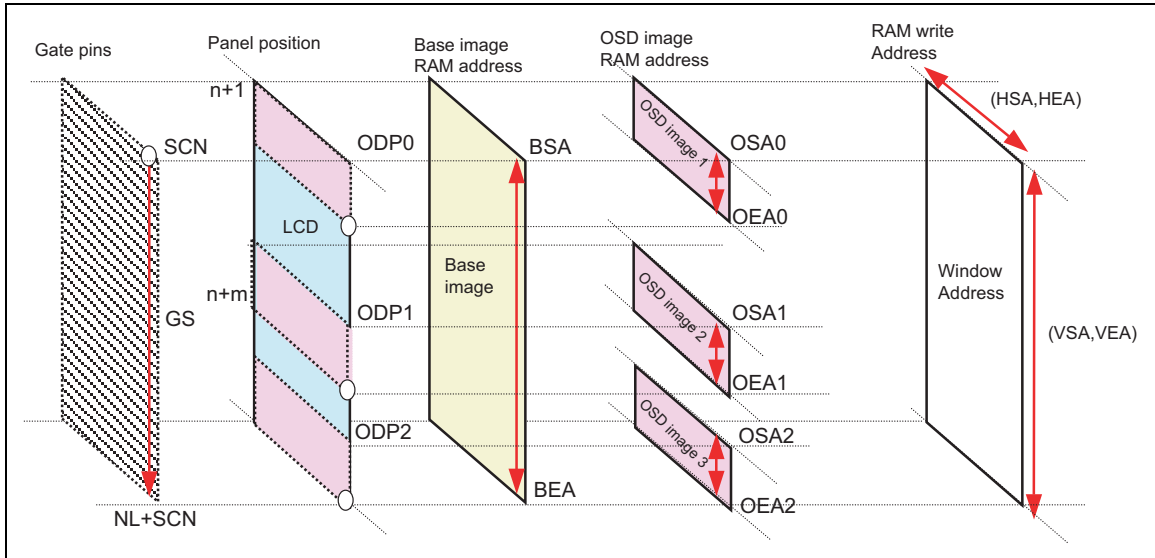

RAM Address, display position, drive position

Whenever making an OSD image setting, the following must be observed.

1. Set the OSD RAM area with OSA_x, OEA_x not to overlap one another.
2. Set the OSD position so that an OSD image does not overlap one another.

$$\begin{aligned}
 0 &\leq \text{ODP0} \leq \text{ODP0} + n \times (\text{OEA0} - \text{OSA0} + 1) - 1 < \\
 &\text{ODP1} \leq \text{ODP1} + n \times (\text{OEA1} - \text{OSA1} + 1) - 1 < \\
 &\text{ODP2} \leq \text{ODP2} + n \times (\text{OEA2} - \text{OSA2} + 1) - 1 \leq \text{NL}
 \end{aligned}$$

“n” is a magnification scale of an OSD image.

3. An OSD image is displayed 100% when the base image is turned off (BASEE = 0).
4. During the interlaced drive (FLD = 2'h3), the OSD and α blending functions are not available.

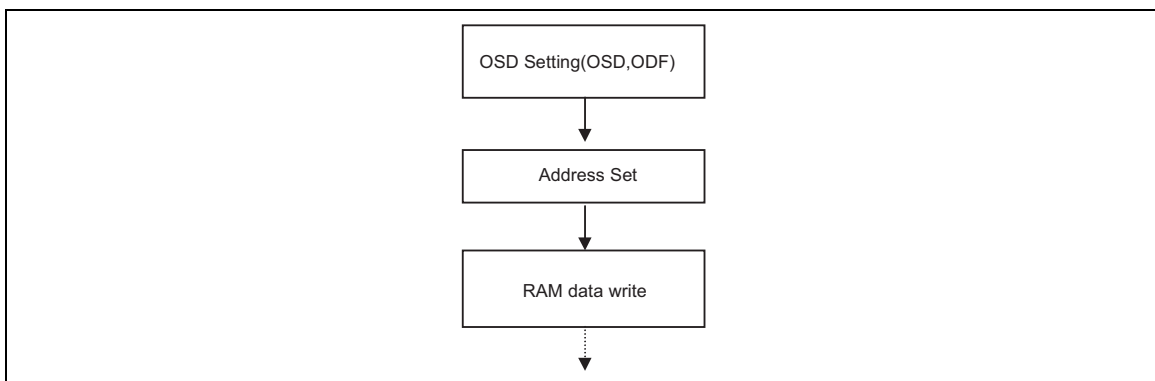

OSD data write flow

Resizing function

The HD66781 incorporates resizing function (contraction: x 1/2, x 1/4, magnification: x2) available when writing picture data.

Contraction

The HD66781 enables to write resized image data to RAM by simply transmitting original image data to the window address as usual with the setting of RSR bit that specifies the contraction rate.

This means the HD66781 allows the system simply to transmit data as usual even if resizing is required, and therefore makes resized images easily available on cameras, sub panels, or as a thumbnail display of a picture.

The HD66781 performs contraction resizing simply by selecting pixels. The resized image may seem distorted from the original image. Check the resized image before use.

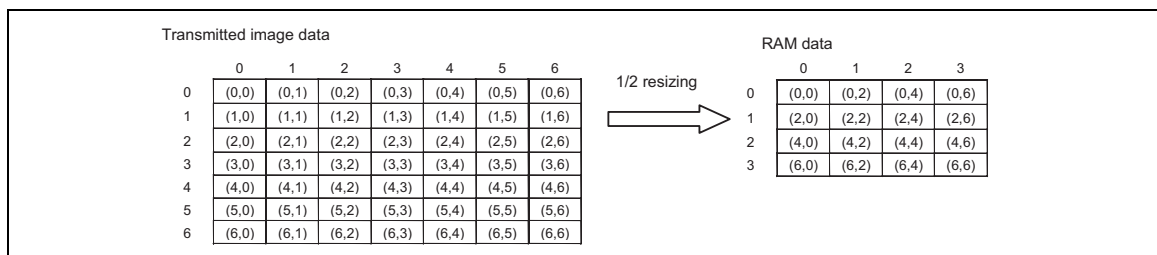

Resizing: contraction

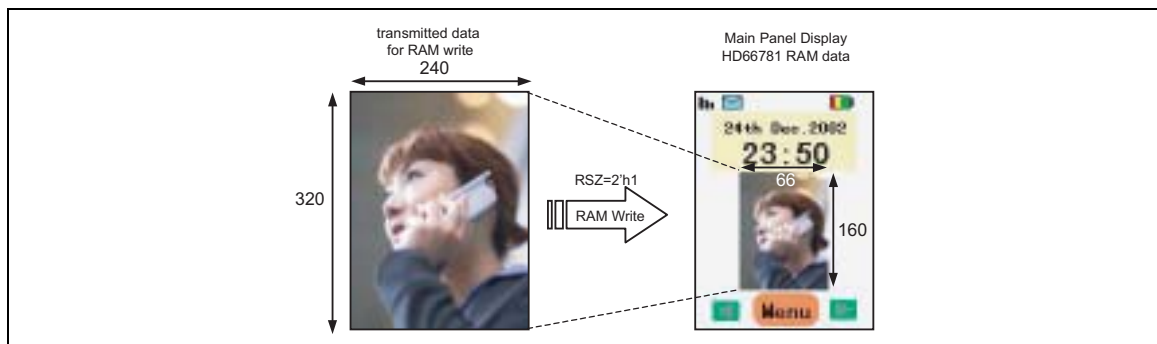

Resizing transmission, display example

Table 56

Original image size (X x Y)	Resized image size	
	1/2 (RSZ = 2'h1)	1/4 (RSZ = 2'h3)
640x480(VGA)	320x240	160x120
352x268 (CIF)	176x144	88x72
320x240 (QVGA)	160x120	80x60
176x144 (QCIF)	88x72	44x36
120x160	60x80	30x40
132x176	66x88	33x44

Resizing setting

The HD66781 selects resizing (contraction) rate according to the setting of RSR bit. Specify the RAM window-address range to fit into the resized picture. If resizing creates surplus pixels according to the result of calculation using the following formulas, set them in RCV, RCH registers before writing data to RAM.

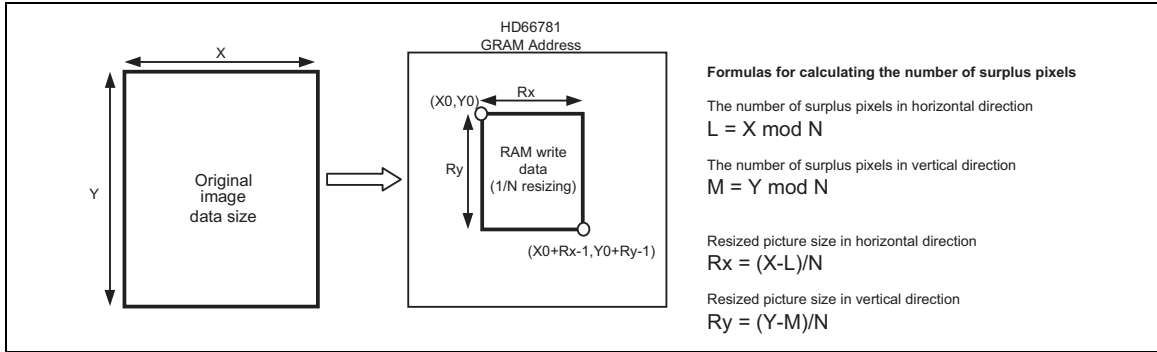

Resizing Setting, surplus pixel calculation

Table 57

Original image (before resizing)

number of data in horizontal direction	X
number of data in vertical direction	Y
resizing ratio	1/N

HD66781 settings

Resizing setting	RSR	N-1
number of data in horizontal direction	RCV	L
number of data in vertical direction	RCH	M

RAM writing start address	AD	(X0, Y0)
RAM window address	HSA	X0
	HEA	X0+Rx - 1
	VSA	Y0
	VEA	Y0+Ry - 1

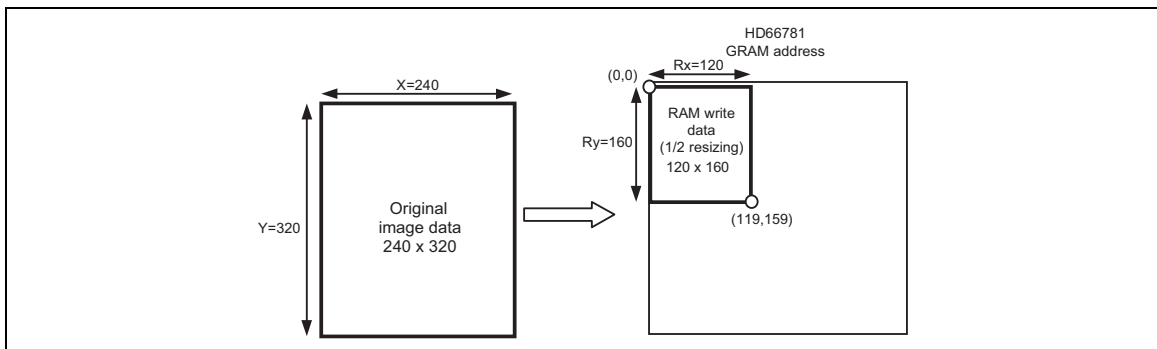

Resizing setting example (1/2 size)

Table 58

Original image (before resizing)

number of data in horizontal direction	X	240
number of data in vertical direction	Y	320
resizing ratio	1/N	1/2

HD66781 settings

Resizing setting	RSR	2'h1
number of data in horizontal direction	RCV	2'h0
number of data in vertical direction	RCH	2'h0

RAM writing start address	AD	17'h00000
RAM window address	HSA	8'h00
	HEA	8'h77
	VSA	8'h00
	VEA	8'h9F

Instructions for Resizing

Table 59 Resizing ratio

RSR[1:0]	ratio
2'h0	No resizing (x 1)
2'h1	1/2 resizing (x 1/2)
2'h2	setting disabled
2'h3	1/4 resizing (x 1/4)

Table 60 Surplus pixels

vertical direction

RCV[1:0]	surplus pixels
2'h0	0
2'h1	1 pixel
2'h2	2 pixels
2'h3	3 pixels

1 pixel = 1 RGB

horizontal direction

RCH[1:0]	surplus pixels
2'h0	0
2'h1	1 pixel
2'h2	2 pixels
2'h3	3 pixels

1 pixel = 1 RGB

Notes to the resizing function

1. Make settings for resizing instructions (RSR, RCH, and RCV) before writing data to RAM.
2. Write data to RAM from the start position of the window address by line when using resizing function.
3. Fit the window-address range into the size of the resized picture.
4. Make an address set before writing data to RAM when using resizing function.
5. Settings for RCH, RCV are only required when using resizing function. Otherwise (RSR = 2'h0), set RCH = RCV = 2'h0.

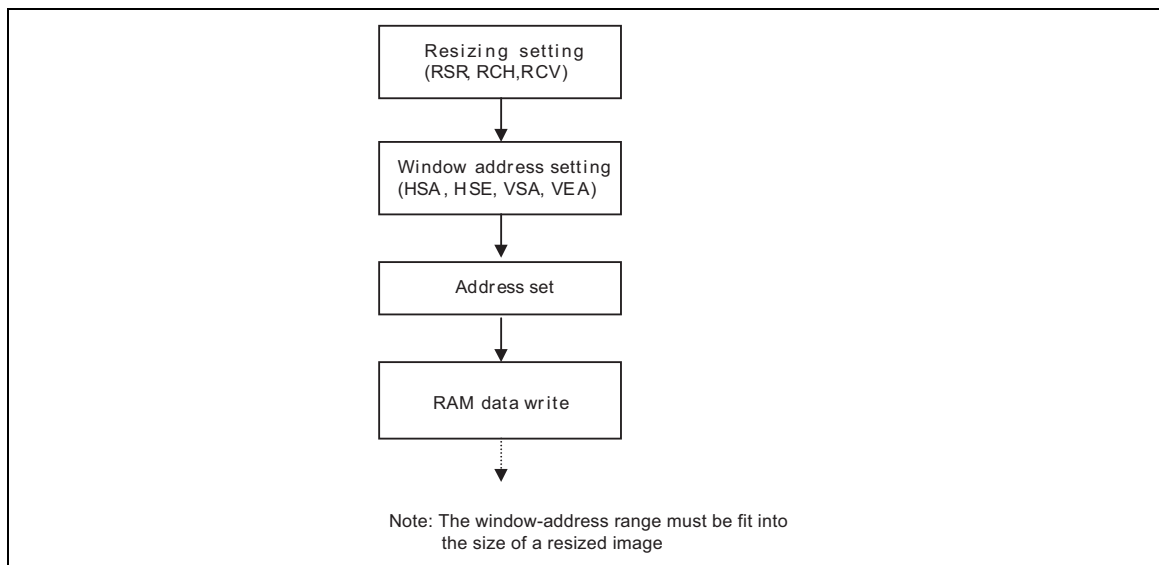
**RAM Writing flow when using resizing**

Magnification

The HD66781 enables to write resized image data to RAM by simply transmitting original image data to the window address as usual with the settings of RESH/RESEV[7:0] bits that specify the magnification rate each for the base and OSD images. The magnification rate is specified each for the base and OSD images. Also, only a part of RAM area of a base image can be magnified on display in the vertical direction. This means the HD66781 allows the system simply to transmit an original data as usual even when displaying a magnified image on a large screen, and therefore enables to reduce the data transmission required for a large screen display.

The display magnification in the vertical direction should be specified by line.

Base image: The image specified by ESA[8:0] and EEA[8:0] on RAM is magnified on display by the scale set by the RSEV[1:0] setting.

OSD image: The image specified by OSAx[8:0] and OEAx[8:0] on RAM is magnified on display in the manner set by the RSEV[7:2] setting.

When magnifying in the horizontal direction, the window-address settings (HSA[0], HEA[0]), RAM address set (AD[0]), and horizontal incremental direction of the counter (I/D[0]) as follows.

Table 61

Registers	Register setting
HSA[0]	1'b0
HEA[0]	1'b1
AD[0]	1'b0 when I/D[0]=0
	1'b1 when I/D[0]=1

The HD66781 performs magnification resizing simply by inserting pixels. The resized image is an extended original image in both horizontal and vertical direction. Check the resized image before use.

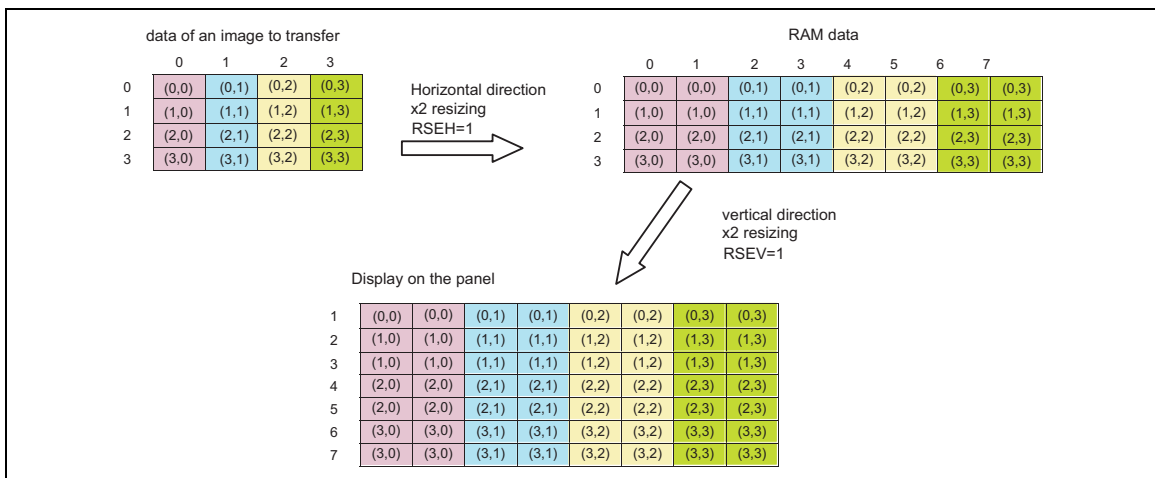

Resizing: magnification

The following figure illustrates the relationship of RAM address, display position and panel driving position when a base image is magnified in the vertical direction.

$$RESV[1:0] = 2 \cdot h1$$

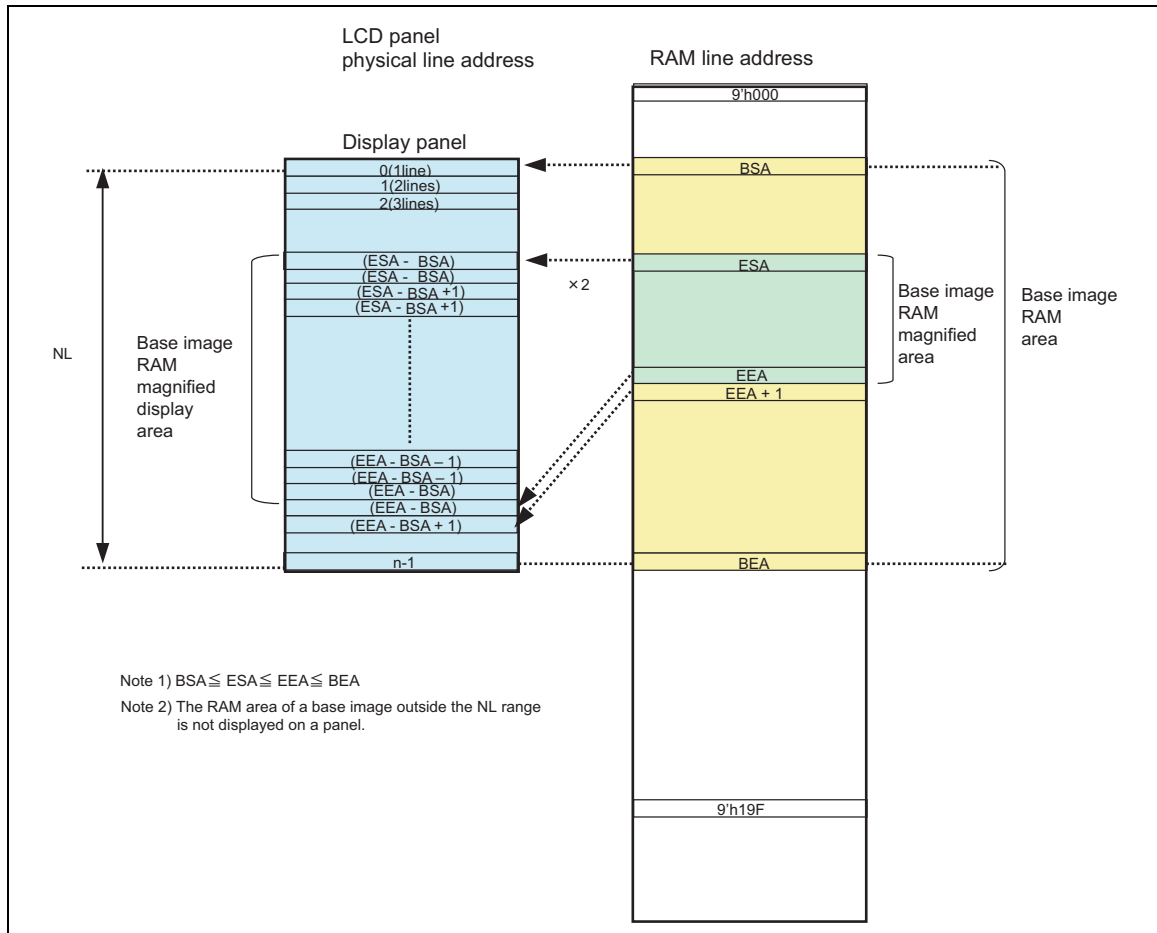

$$RSEV[3:2] = 2'h1, RSEV[5:4] = 2'h0, RSEV[7:6] = 2'h0$$

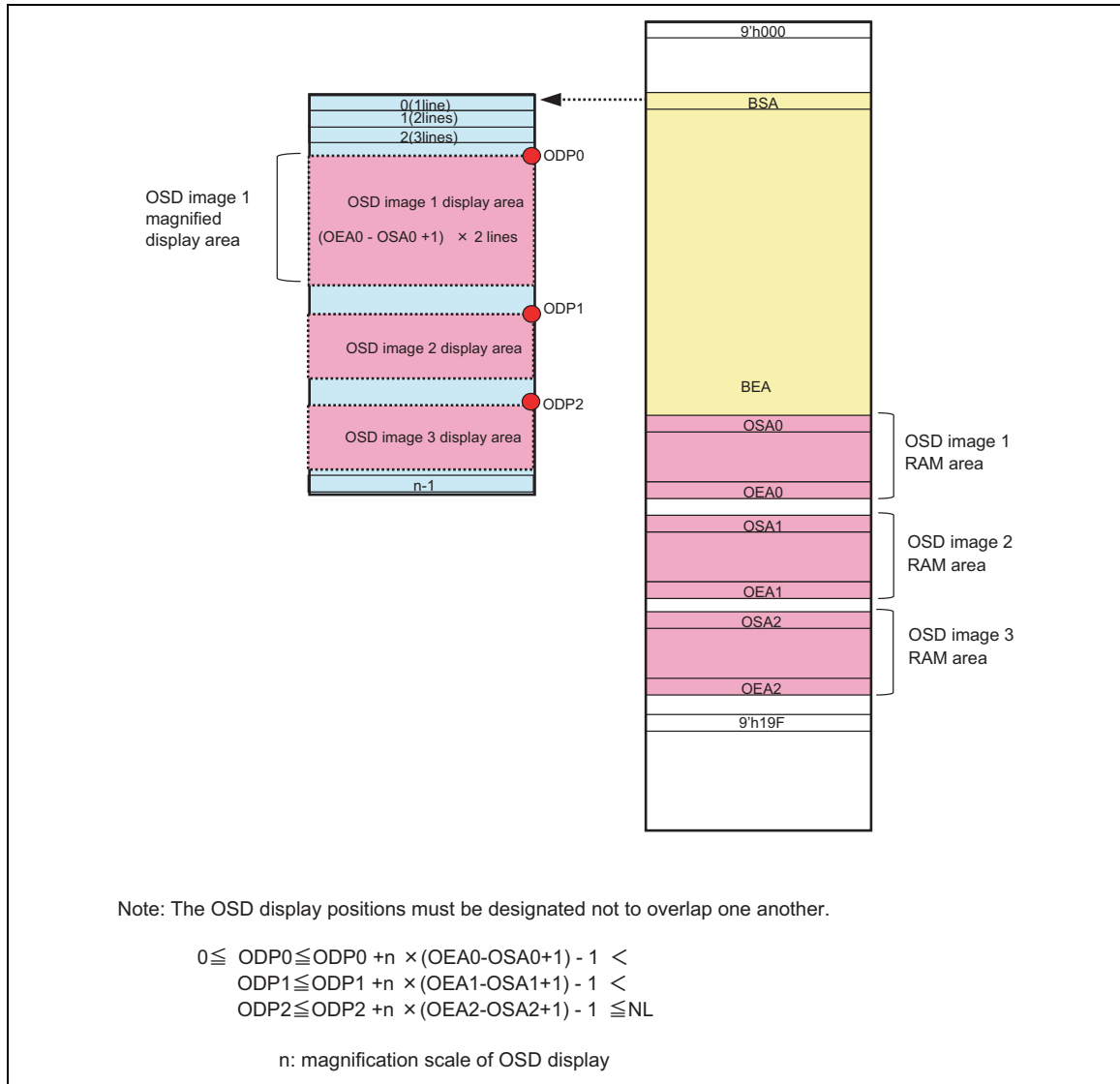

Interface specification

The HD66781 incorporates a system interface to make settings for instructions and an external display interface to display moving pictures. The HD66781 allows selecting an optimum interface for display (moving or still picture, or both) to transmit data efficiently.

The external display interface includes RGB interface and VSYNC interface, which enable flicker-free screen update.

In the RGB-I/F mode, the display operation is performed in synchronization with the signals (VSYNC, HSYNC, and DOTCLK). The display data are written according to the values of the data enable signal (ENABLE), and PD17-0 bits in synchronization with the VSYNC, HSYNC, and DOTCLK signals. The display data are written to GRAM to reduce the data transmission to minimum, i.e. only when the displays are being changed. With the window address function, only the RAM area used for moving picture display is overwritten, and therefore the simultaneous display of moving picture area, which is overwritten, and the RAM data in the area other than the moving picture area, which is not overwritten, is possible. In the RGB and VSYNC interface modes, write data to GRAM in the high speed write mode (HWM = 1) during displaying moving pictures to access to GRAM in high speed with low power consumption.

In the VSYNC interface mode, the frame synchronization signal (VSYNC) synchronizes internal display operations. By writing data in synchronization with the falling edge of VSYNC at a fixed speed to GRAM through a system interface, moving pictures are displayed with the system interface in use. In this case, there are some constraints in the speed and method to write data to RAM.

The HD66781 handles the following 4 operational modes according to the type of display. All settings are made through the external display interface. Transition between the modes must be done according to the transitional flow charts.

Table 62

Operation Mode	RAM Access Setting (RM)	Display Operation Mode (DM1-0)
Internal operating clock only (Displaying still picture)	System interface (RM = 0)	Internal operating clock (DM1-0 = 00)
RGB interface (1) (Displaying moving picture)	RGB interface (RM = 1)	RGB interface (DM1-0 = 01)
RGB interface (2) (Rewriting still picture while displaying moving pictures)	System interface (RM = 0)	RGB interface (DM1-0 = 01)
VSYNC interface (Displaying moving pictures)	System interface (RM = 0)	VSYNC interface (DM1-0 = 10)

Note 1) Instructions are set only through a system interface.

Note 2) RGB-I/F and VSYNC-I/F are not used simultaneously.

Note 3) Do not make a change to the RGB-I/F mode (RIM-0) while the RGB I/F is operating.

Note 4) When making transitions between the interfaces, see the "External Display Interface" (p.139) for the transition flow chart

Note 5) RGB-I/F and VSYNC-I/F modes should be used with the high-speed write mode (HWM = 1).

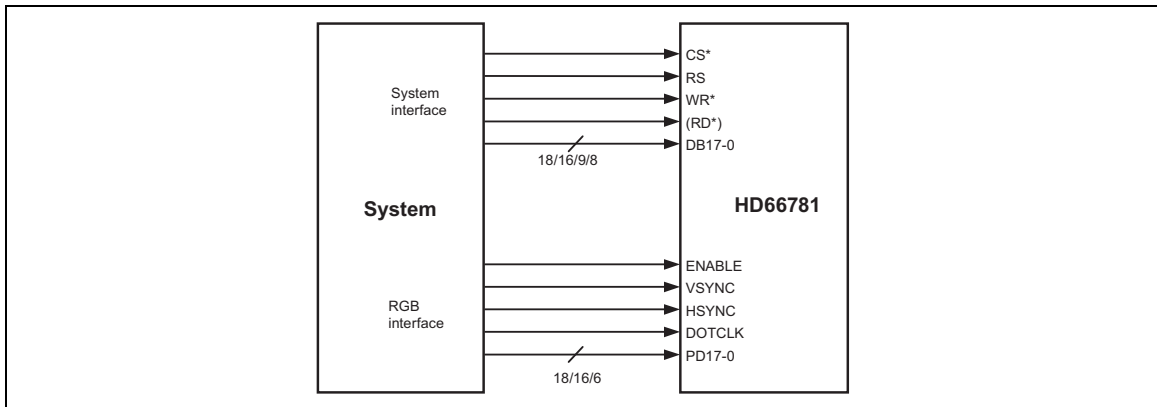

HD66781 Interface

System Interface

The setting with IM3/2/1/0 pins allows selecting among the following system interfaces. The system interface enables instruction settings and RAM access.

Table 63 IM bits settings and system interface

IM3	IM2	IM1	IM0	Interfacing mode with MPU	DB Pin	Colors
0	0	0	0	Setting disabled		
0	0	0	1	Setting disabled		
0	0	1	0	80-system 16-bit interface	DB17 to 10 and 8 to 1	65,536 (262,144) ^{Note 2)}
0	0	1	1	80-system 8-bit interface (Big endian)	DB17 to 10	65,536 (262,144) ^{Note 2)}
0	1	0	*	Serial Peripheral interface (SPI)	DB1 to 0	65,536
0	1	1	0	Setting disabled		
0	1	1	1	80-system 8-bit interface (Little endian)	DB17 to 10	65,536 (262,144) ^{Note 2)}
1	0	0	0	Setting disabled		
1	0	0	1	Setting disabled		
1	0	1	0	80-system 18-bit interface	DB17 to 0	262,144
1	0	1	1	80-system 9-bit interface	DB17 to 9	262,144
1	1	*	*	Setting disabled		

Note 1) 262,144 colors in 16-bit data bus 2-transmission mode.

Note 2) 262,144 colors in 8-bit data bus 3-transmission mode.

80-system 18-bit interface

80-system 18-bit parallel data transmission is selected by setting IM3/2/1/0 pins to Vcc1/GND/Vcc1/GND levels.

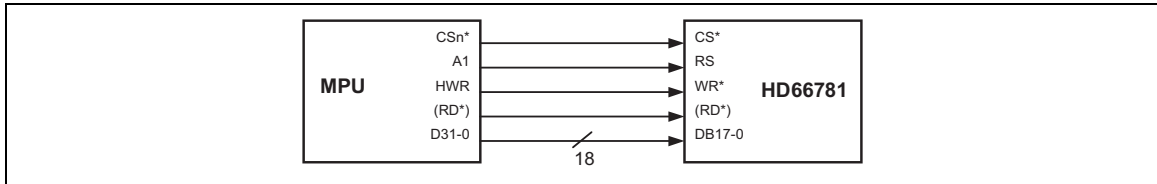

Example of Interface with the 18-bit Microcomputer

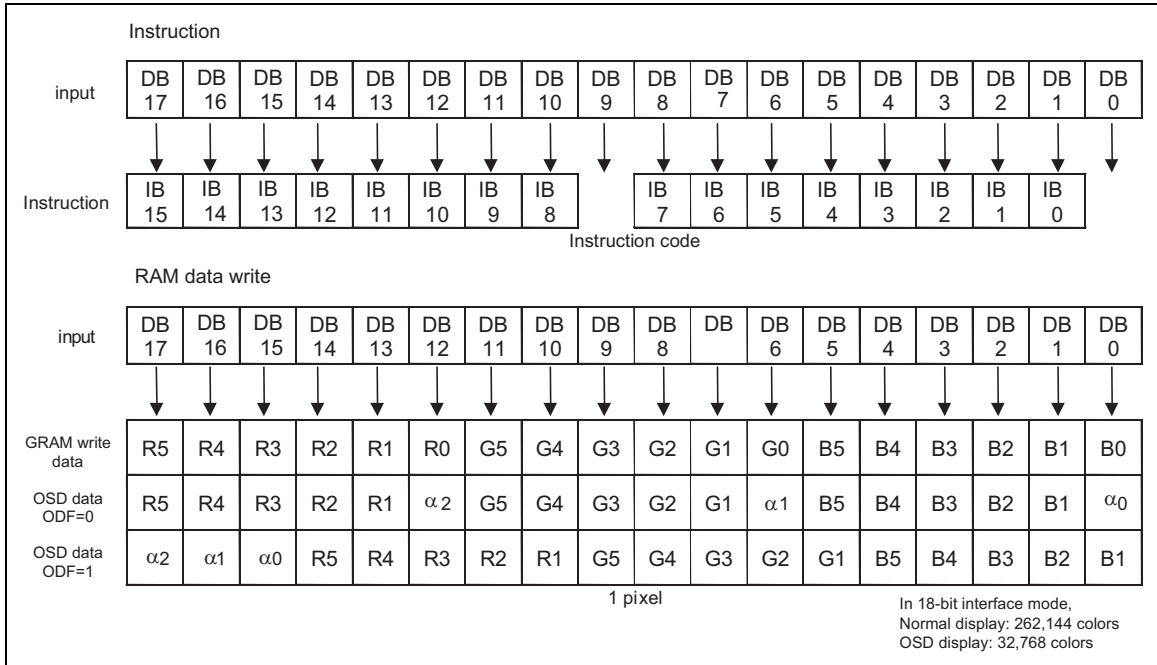

18-bit interface data format (Instruction / RAM write data)

80-system 16-bit interface

80-system 16-bit parallel data transmission is selected by setting IM3/2/1/0 pins to GND/GND/Vcc1/GND levels.

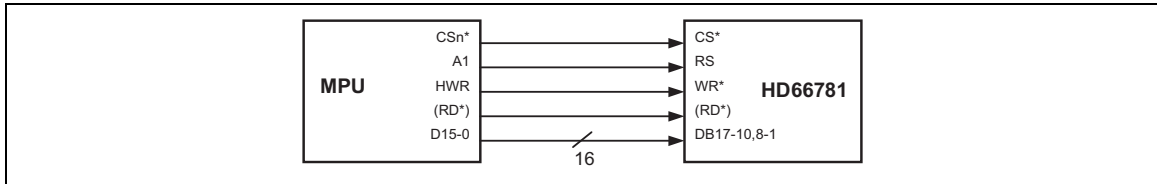

16-bit microcomputer and interface (example)

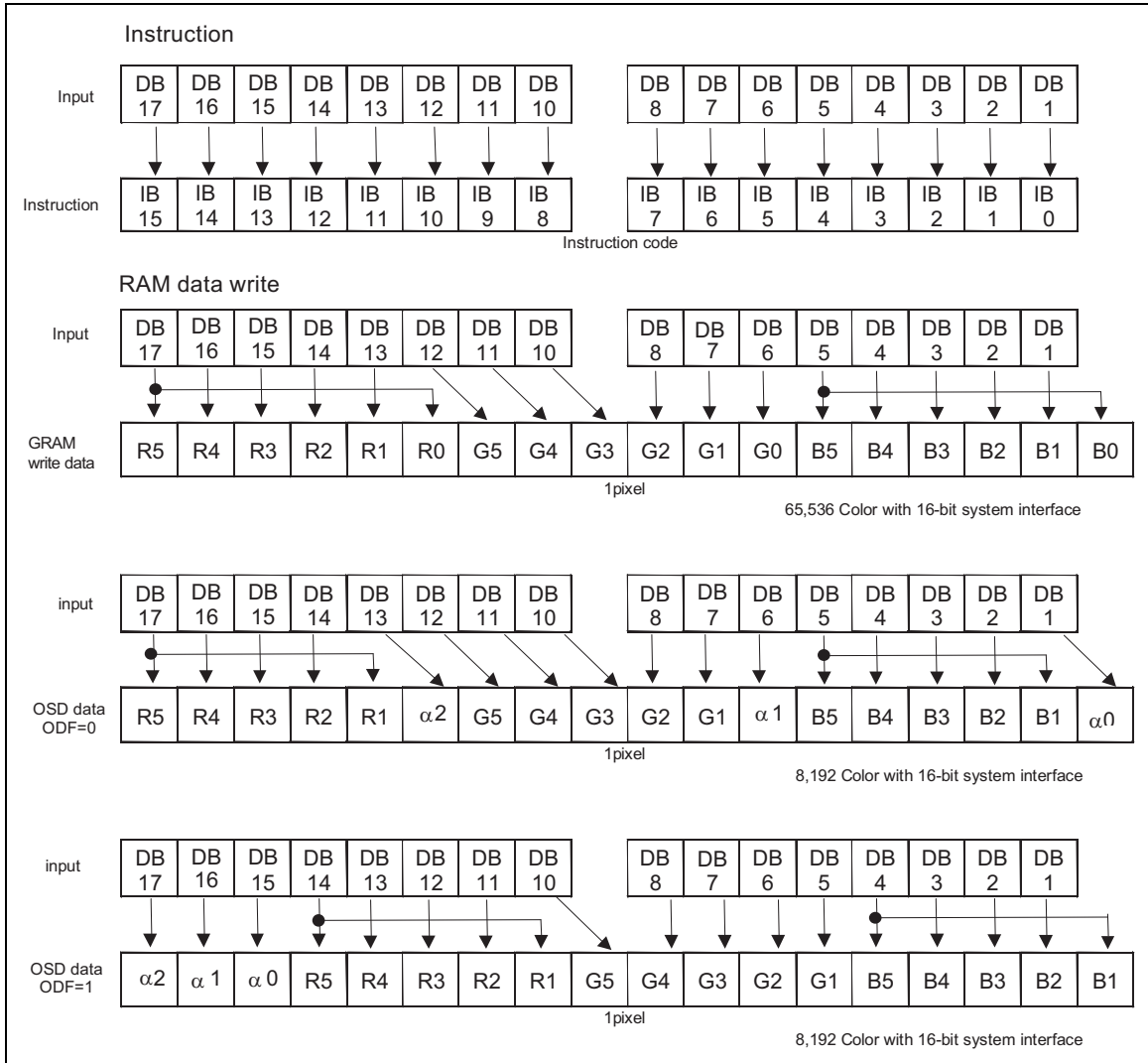

16-bit interface data format (Instruction / RAM write data)

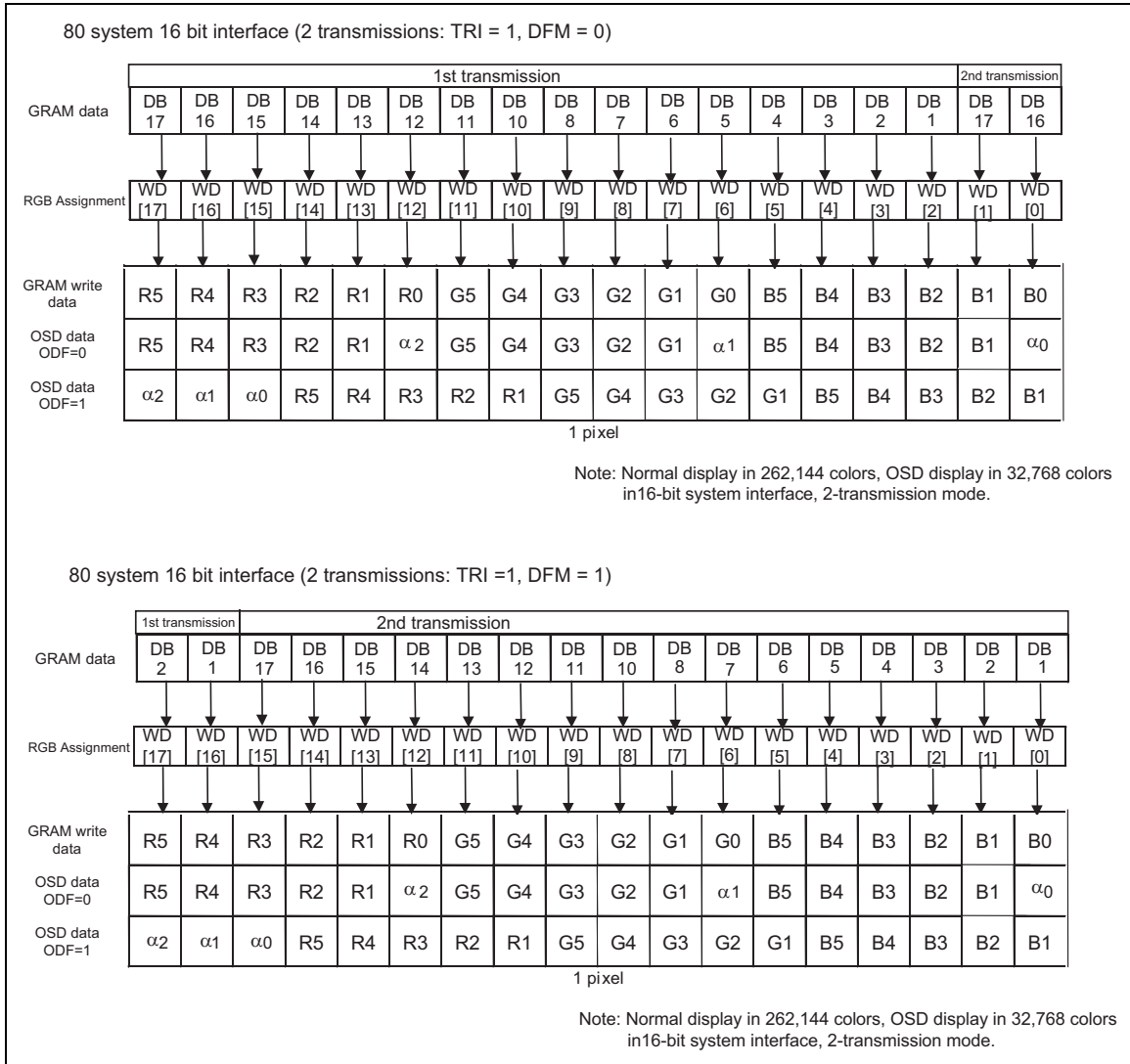

16-bit interface data format (RAM write data in 2-transmission mode)

Data transmission synchronization in 16-bit bus interface mode

The HD66781 supports the data transmission synchronization function, which resets the counter that counts the number of data transmission of upper 2 bits and lower 16 bits or upper 16 bits and lower 2 bits in the 16-bit data bus interface 2-transmission mode. When a discrepancy occurs in the data transmission of the upper/lower bits due to effects from noise and so on, the "000" H instruction is written 4 times consecutively to reset the upper/lower counters so that data transmission restarts with the upper bit transmission. Periodical execution of synchronization function allows the display system to recover from excursion.

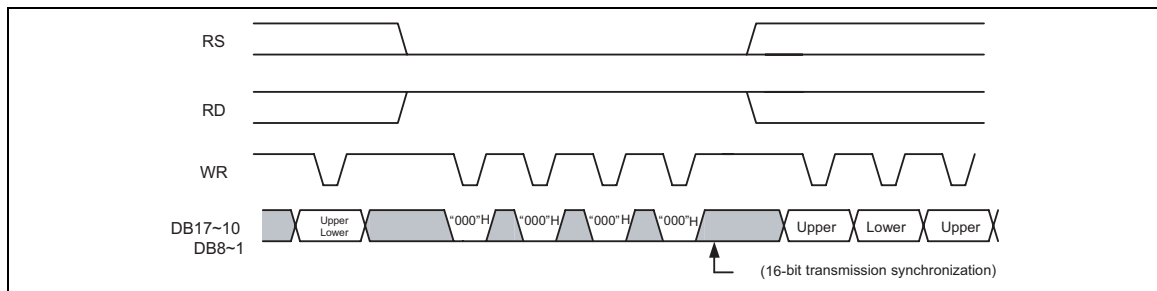

Data Transmission Synchronization

80-system 9-bit interface

The 80-system 9-bit parallel data transmission through DB17-9 pins is selected by setting IM3/2/1/0 pins to Vcc1/GND/Vcc1/Vcc1 levels respectively. When transmitting a 16-bit instruction, it is divided into upper and lower 8 bits (the LSB is not used) and the upper 8 bits are transmitted first. The RAM data is also divided into the upper and lower 9 bits, and the upper bits are transmitted first. The DB8-0 pins, that are not used, must be fixed to either IOVcc level. When writing the index register, the upper byte (8 bits) must be written.

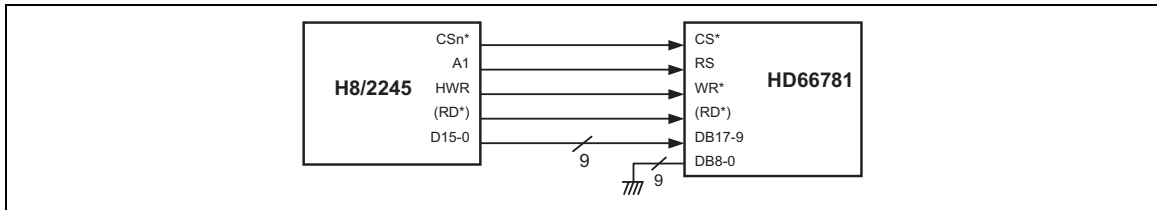

Example of Interface with the 9-bit Microcomputer

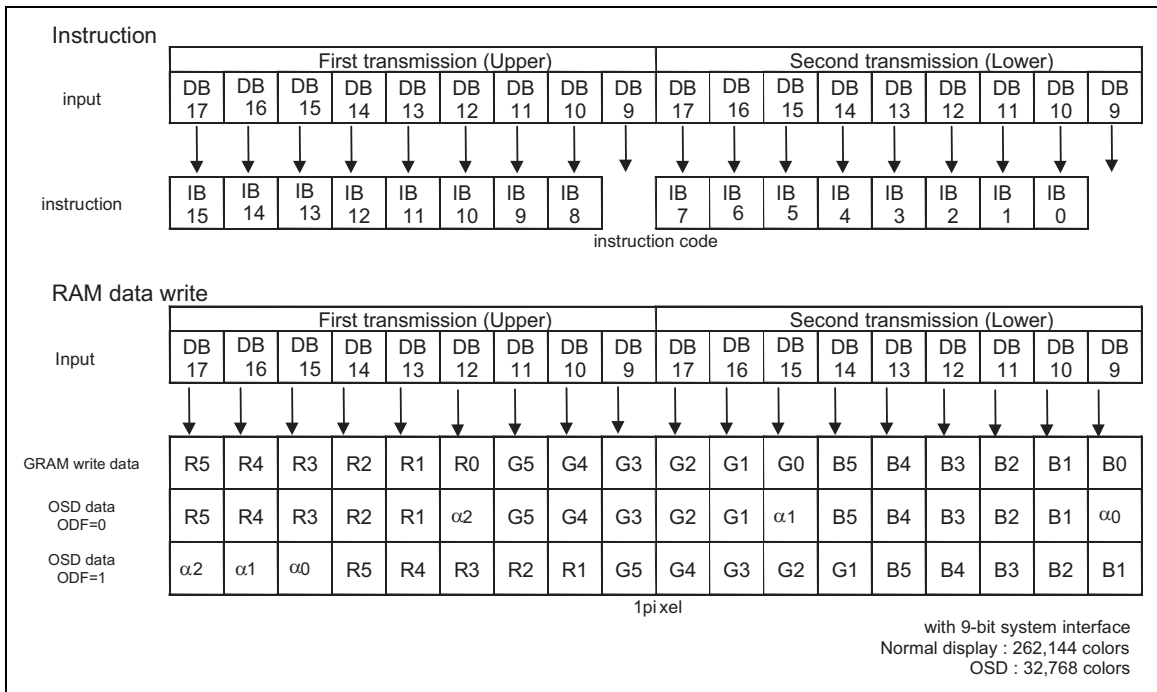

9-bit interface data format

Data transmission synchronization in 9-bit bus interface mode

The HD66781 supports the data transmission synchronization function, which resets the upper/lower counters that count the number of data transmission of upper/lower 9 bits in the 9-bit bus interface mode. When a discrepancy occurs in the data transmission of the upper/lower 9 bits due to effects from noise and so on, the “000” H instruction is written 4 times consecutively to reset the upper/lower counters so that data transmission restarts with the upper 9-bit transmission. Periodical execution of synchronization function allows the display system to recover from excursion.

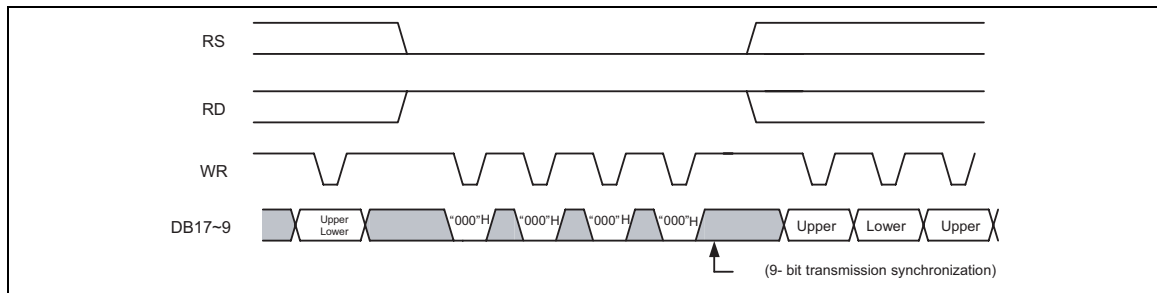

9-bit Transfer Synchronization

80-system 8-bit interface (Big endian)

The 80-system 8-bit parallel data transmission is selected by setting IM3/2/1/0 pins to GND/GND/Vcc1/Vcc1 levels respectively. When transmitting a 16-bit instruction, it is divided into upper and lower 8 bits and the upper 8 bits are transmitted first. The RAM data is also divided into the upper and lower 8 bits, and the upper bits are transmitted first. The data to write to RAM are expanded into 18 bits internally. The DB9-0 pins, that are not used, must be fixed to either IOVcc level. When writing the index register, the upper byte (8 bits) must be written.

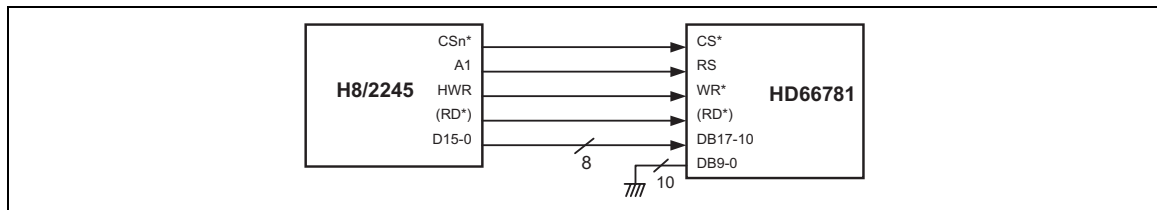

Example of Interface with the 8-bit Microcomputer

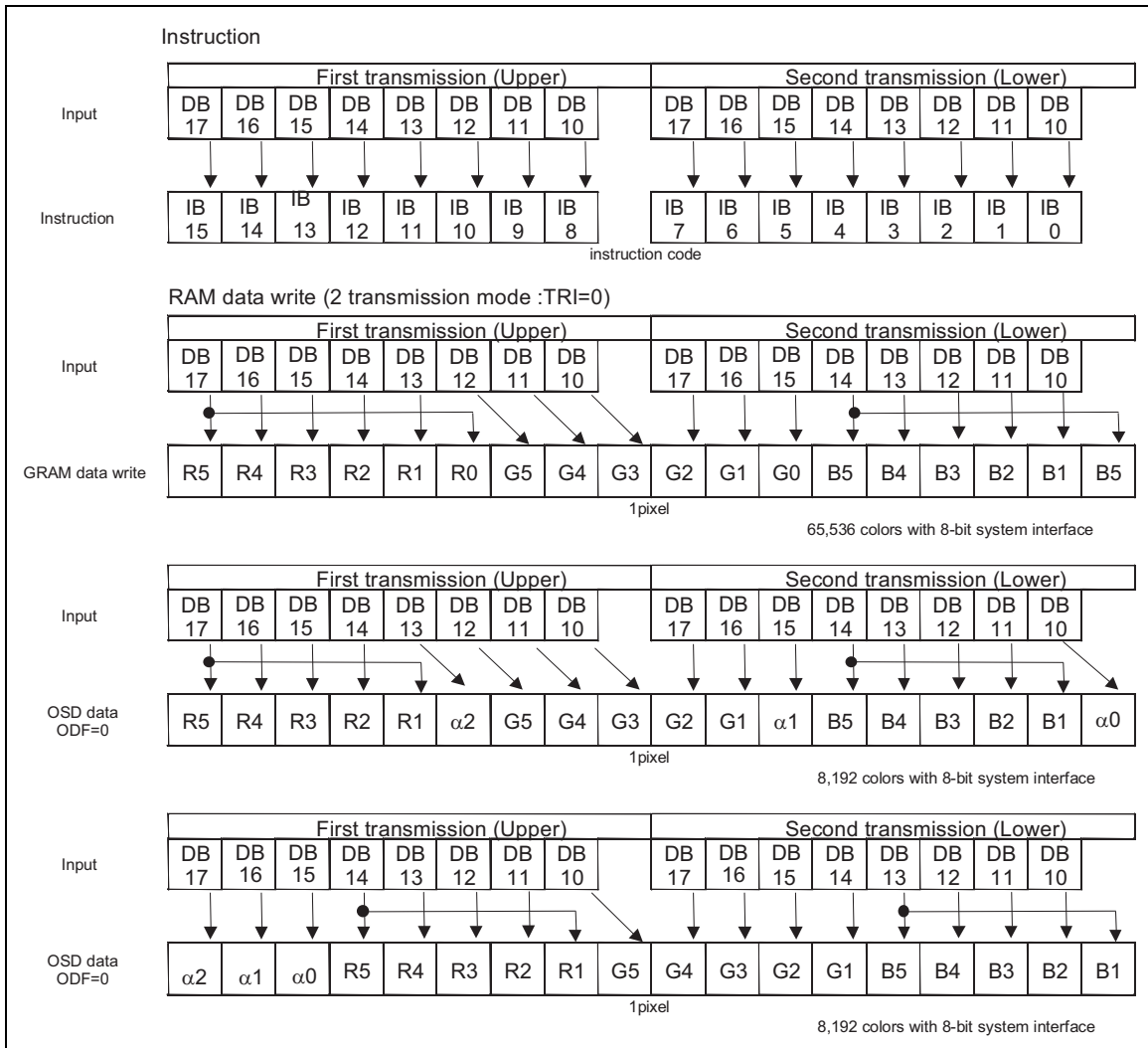

8-bit interface data format, RAM data write (2-transmission mode)

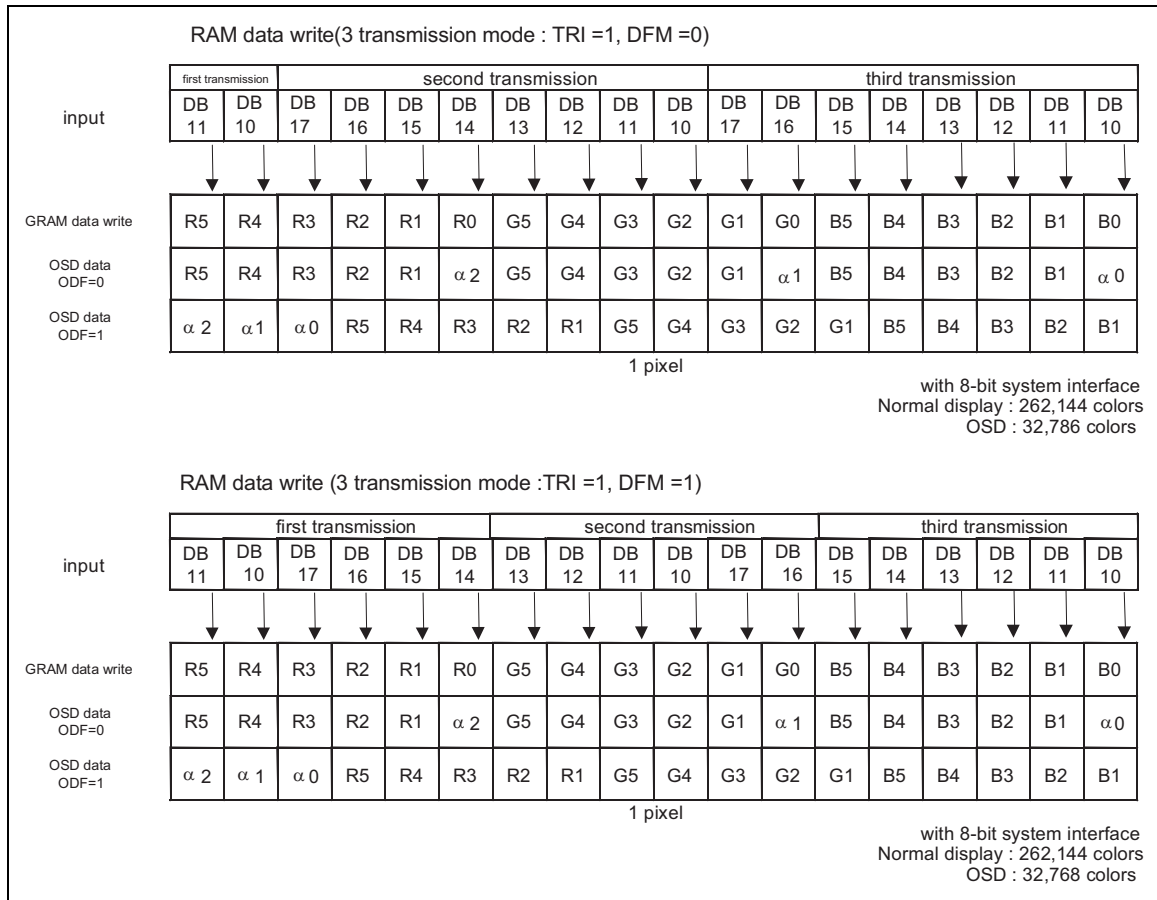

8-bit interface data format, RAM data write (3-transmission mode)

Data transmission synchronization in 8-bit bus interface mode

The HD66781 supports the data transmission synchronization function, which resets the upper/lower counters that count the number of data transmission of upper/lower 8 bits in the 8-bit bus interface mode. When a discrepancy occurs in the data transmission of the upper/lower 8 bits due to effects from noise and so on, the "00" H instruction is written 4 times consecutively to reset the upper/lower counters so that data transmission restarts with the upper 8-bit transmission. Periodical execution of synchronization function allows the display system to recover from excursion.

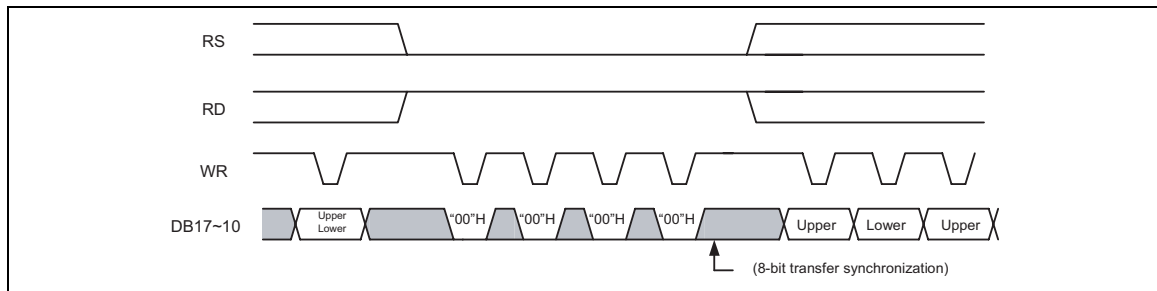

8-bit data transmission synchronization

Serial Peripheral interface (SPI)

The Serial Peripheral Interface (SPI) is selected by setting IM3/2/1 pins to GND/Vcc1/GND levels respectively. The SPI is available through the chip select line (CS), serial transfer clock line (SCL), serial data input (SDI), and serial data output (SDO). In the SPI mode, the IM0/ID pin functions as ID pin. In the SPI mode, the DB17-2 pins, which are not used, must be fixed at either IOVcc level.

The HD66781 recognizes the start of data transfer at the falling edge of CS input to initiate the transfer of start byte. It recognizes the end of data transfer at the rising edge of CS input. The HD66781 is selected when the 6-bit chip address in the start byte transferred from the transmission device and the 6-bit device identification code assigned to the HD66781 are compared and both 6-bit data correspond. When selected, the HD66781 starts taking in the subsequent data string. The setting for the least significant bit of the identification code is made with the ID pin. The five upper bits of the identification code must be 01110. Two different chip addresses must be assigned to the HD66781 because the seventh bit of the start byte is assigned to a register select bit (RS). When RS = 0, index register write or status read is executed. When RS = 1, instruction write or RAM read/write is executed. The eighth bit of the start byte is to specify read or write (R/W bit). The data are received when the R/W bit is 0, and are transmitted when the R/W bit is 1.

In the SPI mode, the data are written to GRAM after two-byte data transmission. The data are expanded into 18 bits by adding one bit (the same data as the MSB of RB) to the LSB of RB data.

After receiving the start byte, the HD66781 starts to transmit or receive data by byte. The data transmission adopts a format by which the MSB is first transmitted. All HD66781 instructions consist of 16 bits and they are executed internally after two bytes are transmitted with the MSB first (DB15 to 0). The data to write to RAM are expanded into 18-bit data. After the start byte is received, the first byte is always fetched as the upper eight bits of the instruction and the second byte is fetched as the lower eight bits of the instruction. The 4-byte data that are read from RAM right after the start byte are made invalid. The HD66781 reads as valid data from the 5th-byte data.

Start Byte Format

Transmitted bits	S	1	2	3	4	5	6	7	8
Start byte format	Transmission start	Device ID code						RS	R/W
		0	1	1	1	0	ID		

Note 1) ID bit is selected with the IM0/ID pin.

Table 64

RS	R/W	Function
0	0	Set index register
0	1	Read status
1	0	Write instruction or RAM data
1	1	Read instruction or RAM data

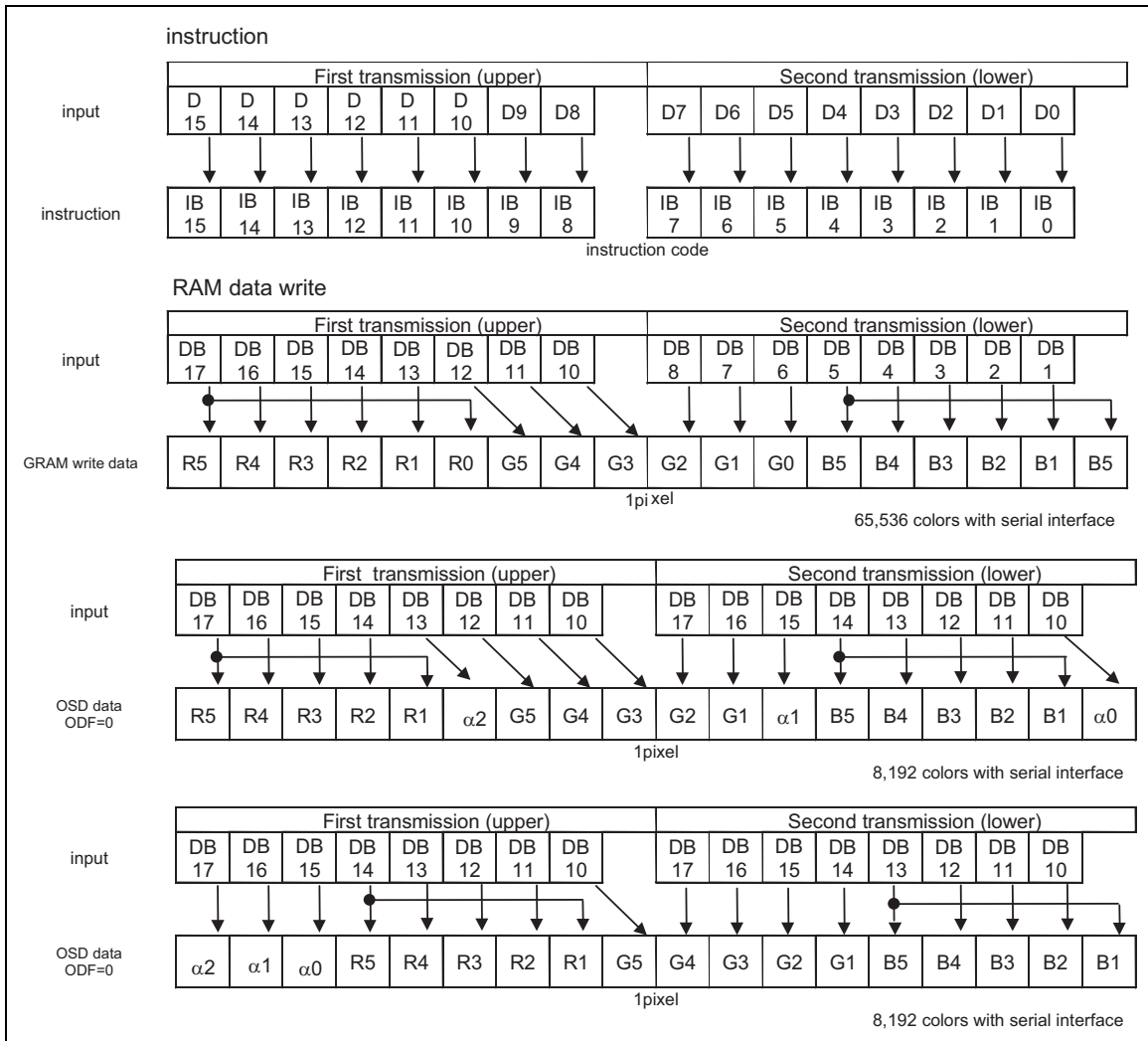

Data format for Serial Peripheral Interface

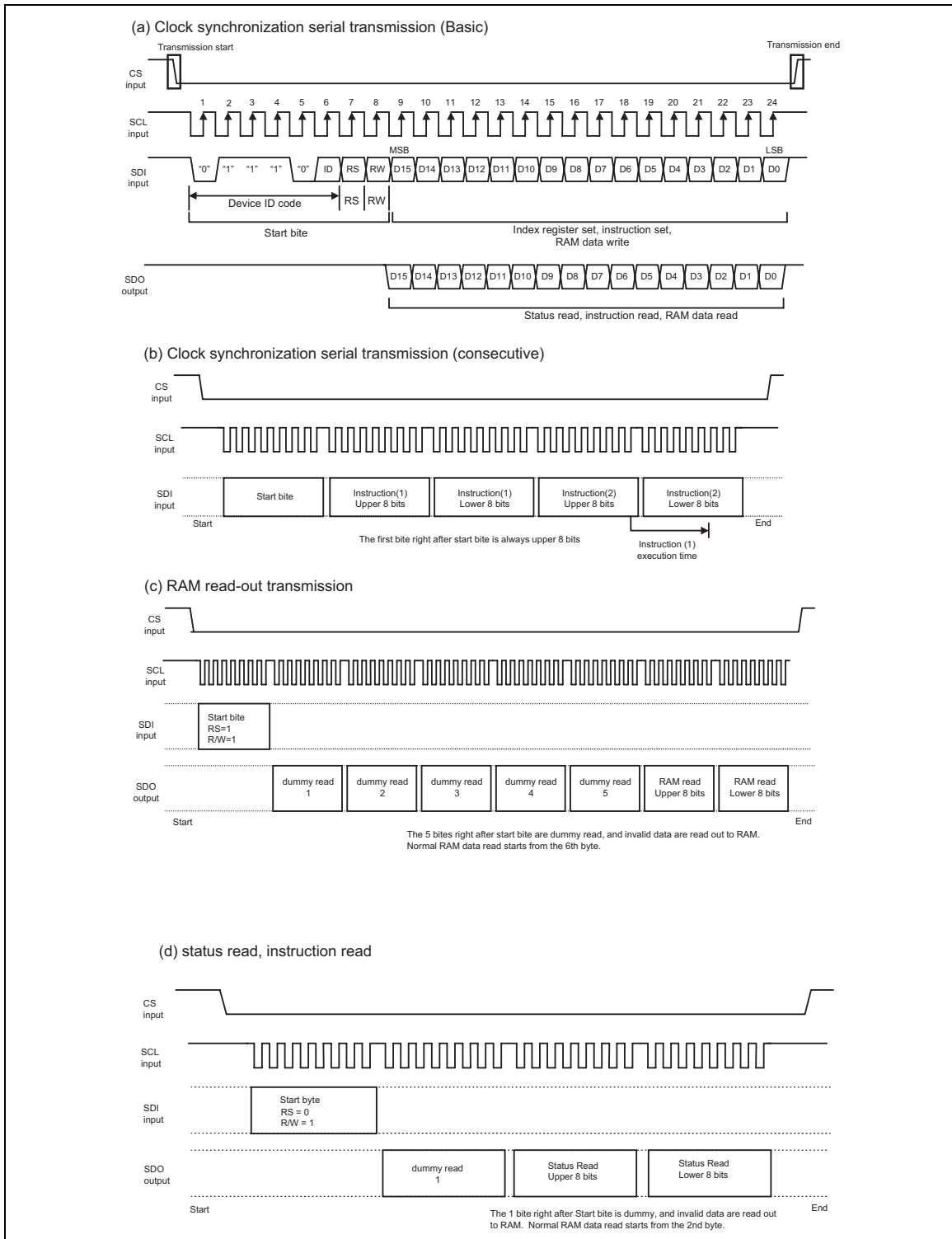

Serial Peripheral Interface: data transfer

80-system 8-bit interface (Little endian)

The 80-system 8-bit parallel data transmission is selected by setting IM3/2/1/0 pins to GND/Vcc1/Vcc1/Vcc1 levels respectively. When transmitting a 16-bit instruction, it is divided into upper and lower 8 bits and the upper 8 bits are transmitted first. The RAM data is also divided into the upper and lower 8 bits, and the upper bits are transmitted first. The data to write to RAM are expanded into 18 bits internally. The DB9-0 pins, that are not used, must be fixed to either IOVcc level. When writing into the index register, the upper byte (8 bits) must be written.

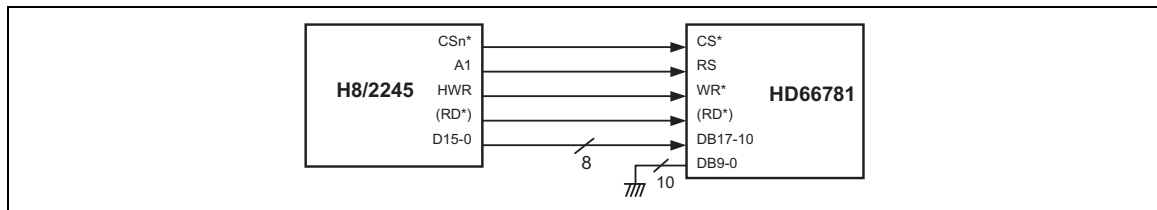

Example of Interface with the 8-bit Microcomputer

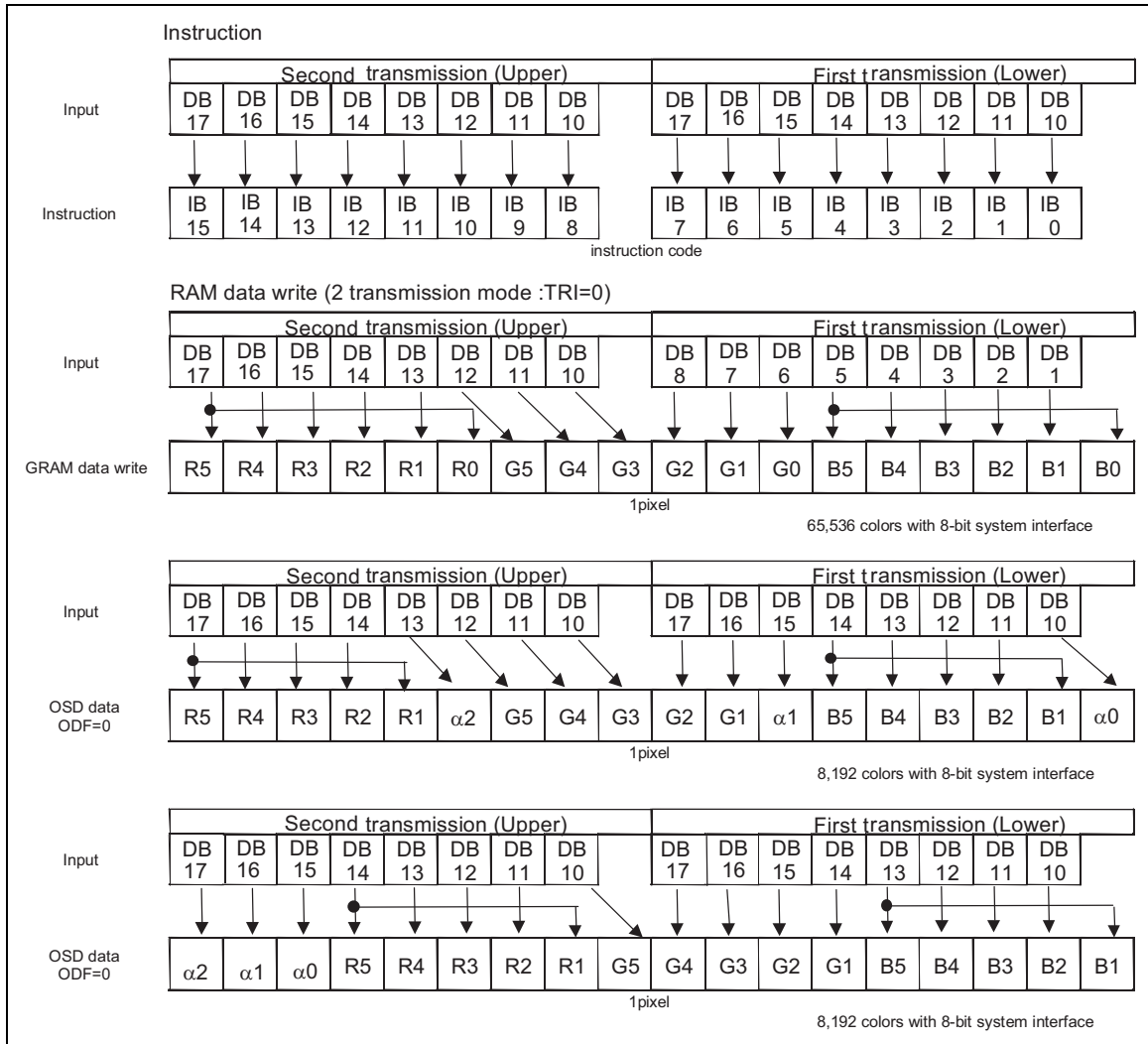

8-bit interface data format, RAM data write (2-transmission mode)

Data transmission synchronization in 8-bit bus interface mode

The HD66781 supports the data transmission synchronization function, which resets the upper/lower counters that count the number of data transmission of upper/lower 8 bits in the 8-bit bus interface mode. When a discrepancy occurs in the data transmission of the upper/lower 8 bits due to effects from noise and so on, the “00” H instruction is written 4 times consecutively to reset the upper/lower counters so that data transmission restarts with the upper 8-bit transmission. Periodical execution of synchronization function allows the display system to recover from excursion.

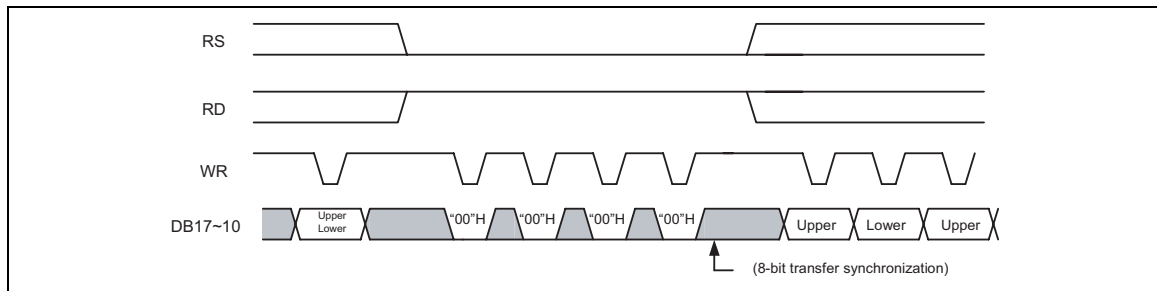

8-bit data transmission synchronization

DMA transfer Single Address mode

When connecting a microcomputer or an application processor, which are compliant to DMA transfer single address mode, with the HD66781, and SRAM or pseudo SRAM, the HD66781 allows using same bus cycle for data read from memory and data write to the HD66781. This reduces transfer time and controls bus occupation ratio when transferring a large volume of data from external memory to a LCD driver.

1. Pin functions in DMA single address mode

DACK: In DMA single address mode, it has the same function as CS in normal operation mode.

RD: Recognize write strobe (WR) internally when DACK is at the low level (active).

WR: Fix to High.

CS: Fix to High.

RS: Recognize a high level (data transfer) inside the HD66781 under any condition when DACK is at the low level (active).

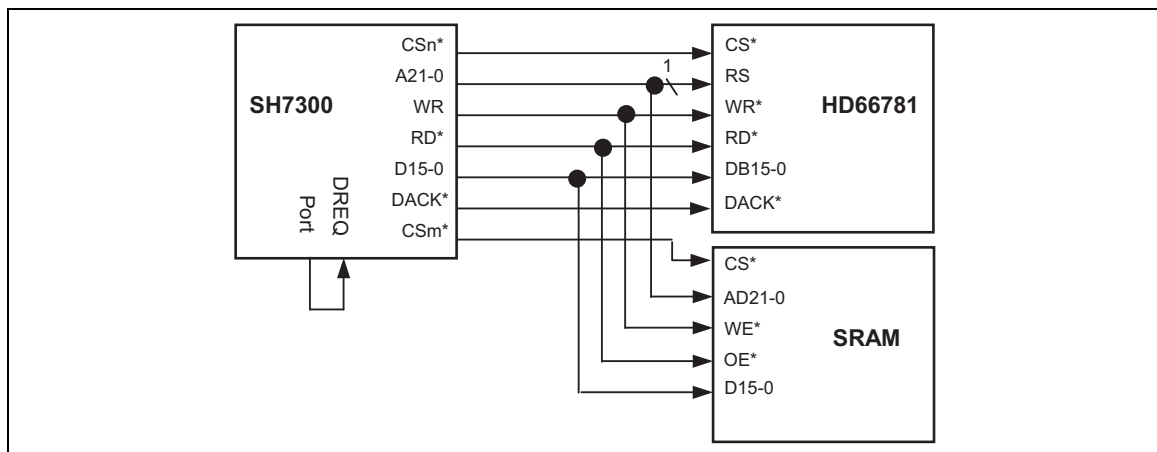

Interfacing with microcomputer and SRAM

2. Transfer procedure in DMA single address mode

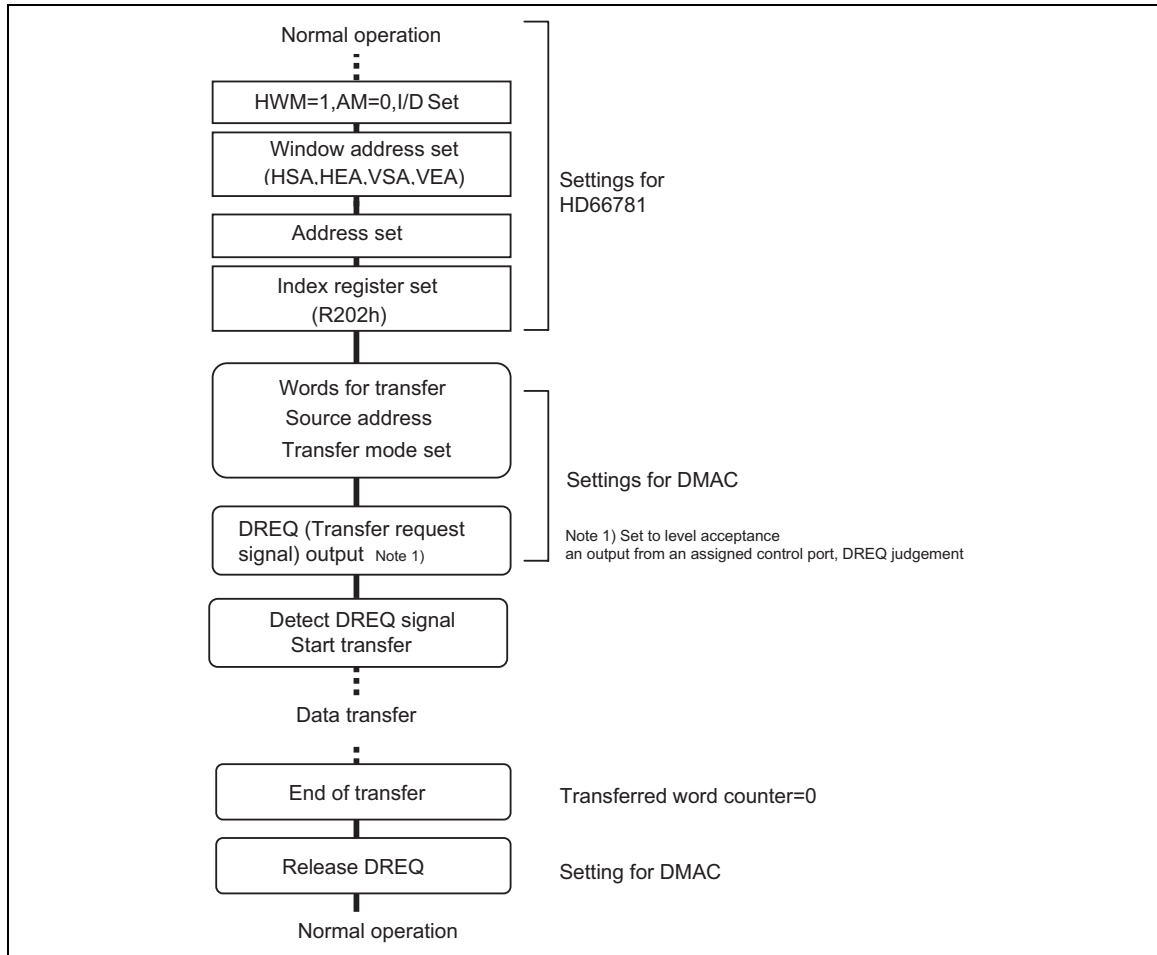

3. Notes to the DMA single address mode

1. DACK*pin and CS*pin cannot be made at a low level (active) simultaneously.
2. Once starting a transfer in the DMA single address mode, no command access to the HD66781 will be allowed until the end of the transfer.
3. The DMA single address mode must be used with the window address function to make sure the number of data transfer in the DMA mode and the numbers of data in the specified window address area correspond.
4. After transferring in the DMA mode, wait at least for RAM write execution time (bus cycle time in the normal write mode, t_{cycw}) before issuing a next instruction.
5. It is not possible to make a transfer from the HD66781 to external memory in the DMA single address mode.
6. The DMA single address mode is compatible with the normal cycle still mode and the burst mode.

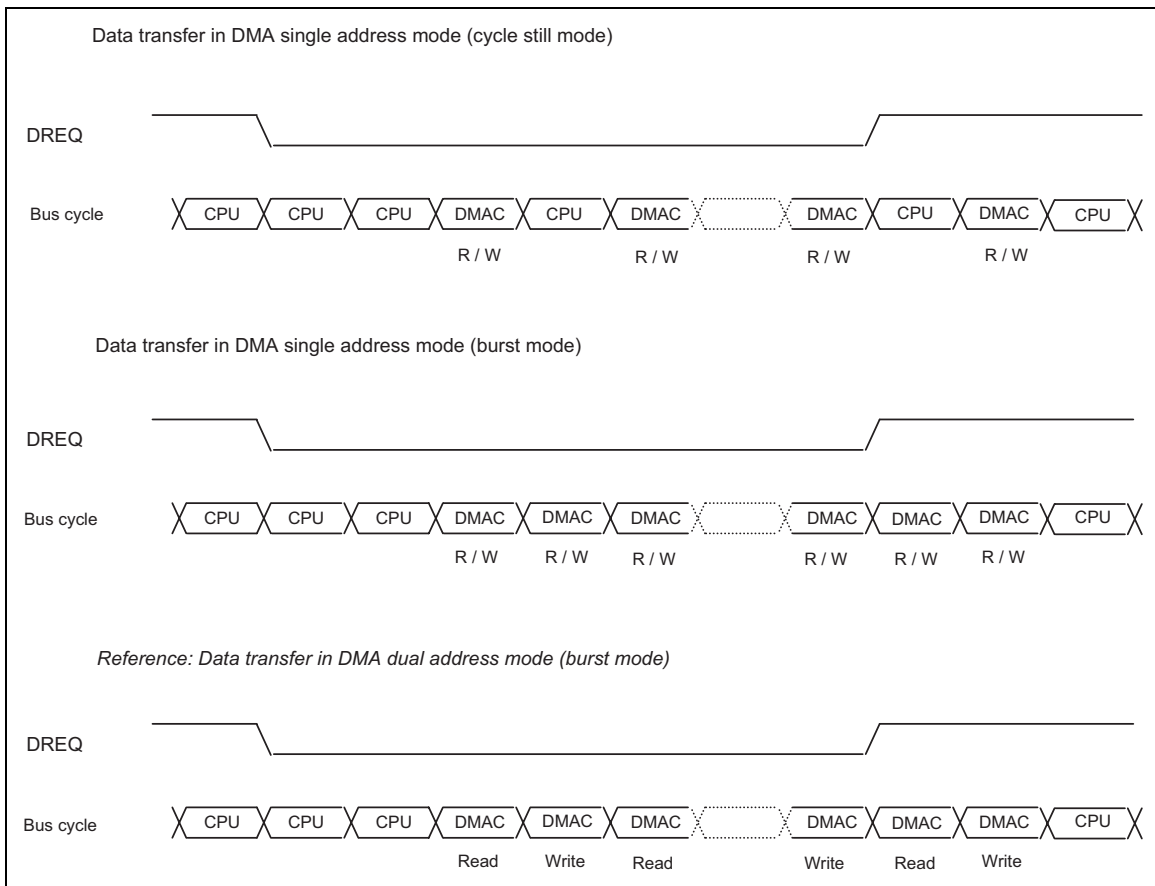

VSYNC Interface

The HD66781 incorporates a VSYNC-I/F, which enables moving picture display with a system interface and the frame synchronization signal (VSYNC) only. This interface enables the display of moving pictures with minimum modification to the conventional system.

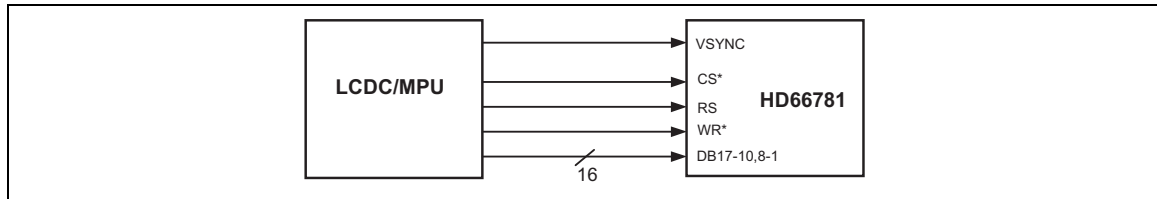

VSYNC interface

The VSYNC-I/F is selected by setting DM1-0 = 10 and RM = 0. In the VSYNC I/F mode, the internal display operations are synchronized with VSYNC. By writing data to RAM through the system interface in a speed that is higher for more than a fixed speed than the internal display operation speed, it enables moving picture display through a system interface and flicker-free screen update.

Display operations are executed by the internal clock generated by the internal oscillator and the VSYNC input. All display data are stored in RAM. Therefore, it only requires transfer of the data that is written over to update the screen, thereby minimizing the numbers of data transfers while displaying moving picture. The use of high-speed write mode (HWM = 1) with VSYNC interface enables RAM access in high speed with low power consumption.

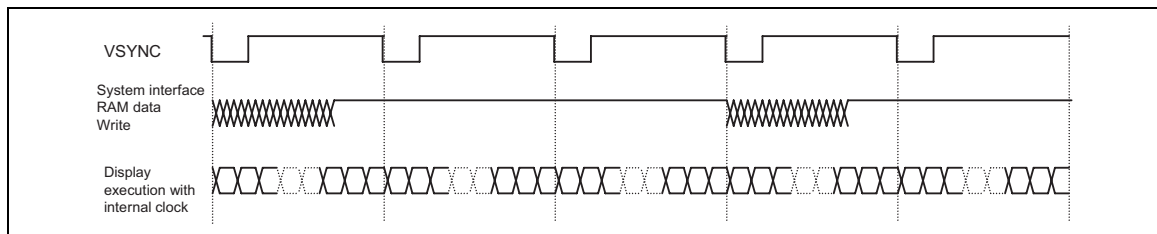

Moving picture data transmission through VSYNC interface

Note 1) Data must be written to RAM in the high-speed write mode (HWM = 1) in VSYNC interface mode.

The VSYNC-I/F has limits on the minimum speed for RAM write through the system interface and the frequency of the internal clock. It requires RAM write speed more than the calculated result from the following formula.

$$\begin{aligned} &\text{Internal clock frequency (fosc) [Hz]} \\ &= \text{Frame frequency} \times (\text{Display raster-row (NL)} + \text{Front porch (FP)} + \text{Back porch (BP)}) \times 16 \text{ clocks} \\ &\quad \times \text{Fluctuation} \\ &\text{RAM writing speed (min.) [Hz]} \\ &> 320 \times \text{Display lines (NL)} / \{(\text{Back porch (BP)} + \text{Display lines (NL)} - \text{margin}) \times 16 \text{ clocks}\} / \text{fosc} \end{aligned}$$

When RAM write does not start immediately after the falling edge of VSYNC, the period from the falling edge of VSYNC to the start of RAM write must also be taken into consideration.

An example of calculations for the internal clock frequency and RAM write speed in the VSYNC interface mode is as follows.

- Calculation Example: moving picture display in VSYNC I/F
- Panel size 240 RGB × 320 raster-rows (NL0 = 6'27)
- Total number of raster-rows(NL) 320 raster-rows
- Back, Front porches 14, 2, raster-rows
(BP = 4'hE, FP = 4'h2)
- Frame frequency 60Hz

$$\begin{aligned} &\text{Internal clock frequency (fosc) Hz} \\ &= 60 \text{ Hz} \times (320 + 2 + 14) \text{ raster-rows} \times 16 \text{ clocks} \times 1.1 / 0.9 = 394 \text{ [kHz]} \end{aligned}$$

When calculating an internal clock frequency, possible causes of fluctuations must also be taken into consideration. The allowance for this fluctuation is $\pm 10\%$ from the center value, and the range of the frequency must be within the VSYNC cycle.

As the causes of fluctuations, the above example takes the variation in the LSI fabrication and the room temperature into account. Other possible causes of fluctuations, such as variation in the external resistors or the voltage change are not considered in the above calculation. It is necessary to make a setting with enough margins to include the allowances for these factors.

$$\begin{aligned} &\text{Minimum RAM writing speed [Hz]} \\ &> 240 \times 320 / \{((14 + 320 - 2) \text{ raster-rows} \times 16 \text{ clocks}) / 394 \text{ kHz}\} = 5.70 \text{ [MHz]} \end{aligned}$$

In this case, RAM write is performed on the input of VSYNC.

When the data for one frame are written to RAM completely, there must be 2 raster-rows or more of a margin before the display raster-rows.

According to the above calculation results, writing data to RAM on the input of VSYNC at the speed of 5.7 MHz or more, the data for the entire screen on RAM are overwritten before the display operation starts. Accordingly, the flicker due to moving picture update can be avoided even if displaying a moving picture.

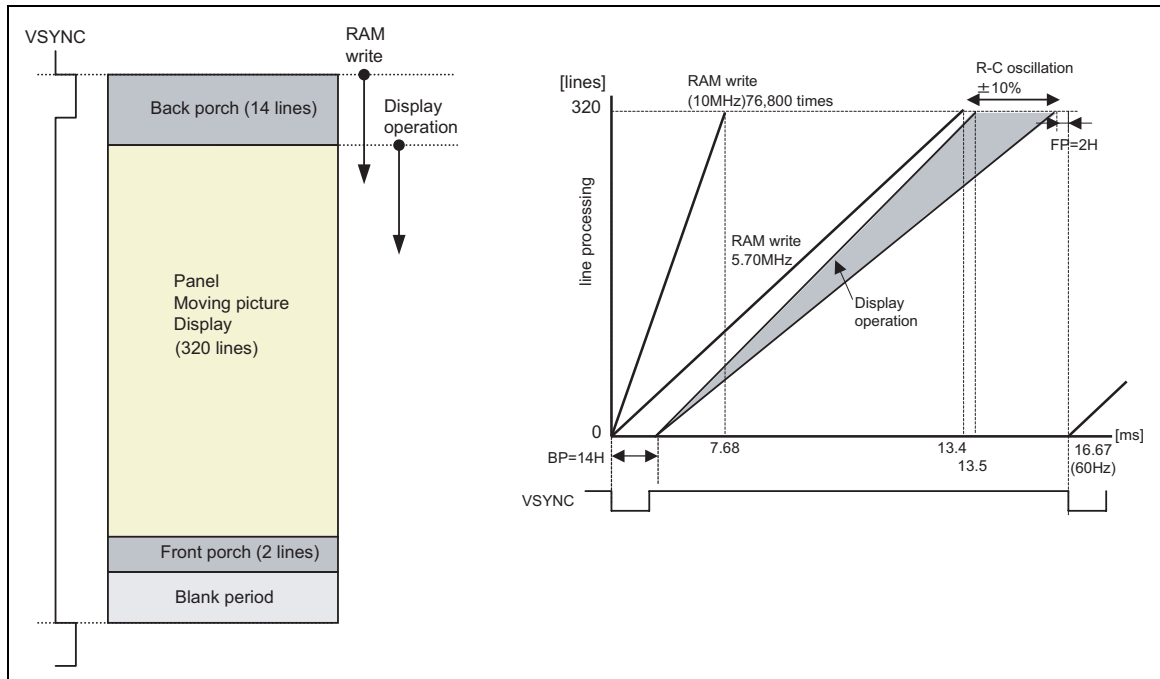

Minimum RAM write speed and internal clock frequency in VSYNC interface

Notes to the VSYNC interface

1. The aforementioned example of calculation is just a result of calculation. In the actual settings, causes for the fluctuations such as internal oscillators and so on should be taken into consideration. It is necessary to make a setting for RAM write speed with enough margins.
2. The aforementioned example of calculation is the value in case of writing over the entire screen. Limiting the area for the moving picture display will create more margins for the RAM write speed.

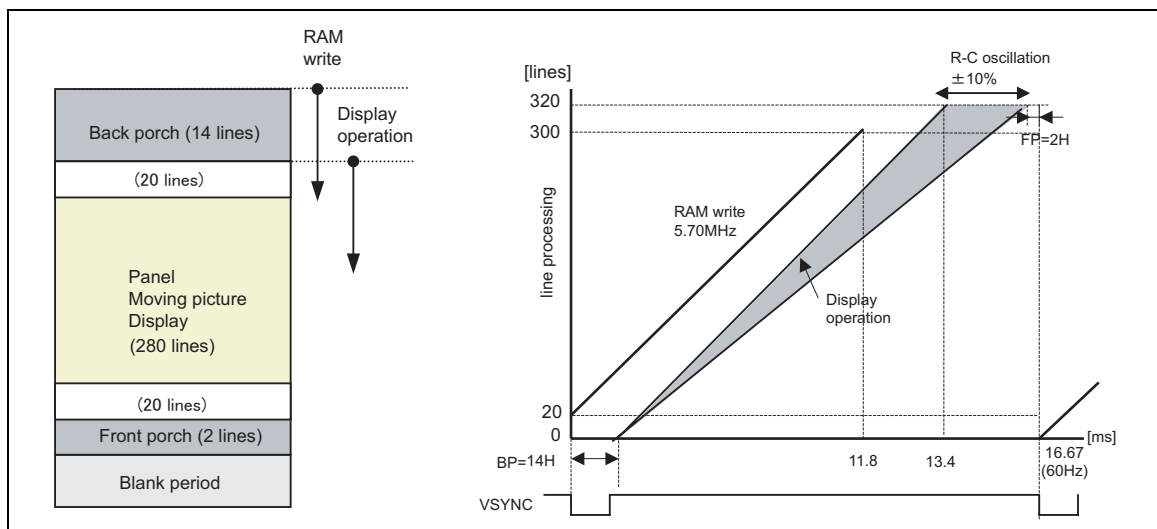

Condition on using VSYNC interface

3. A front porch period continues after the completion of 1 frame display and until the next input of VSYNC.
4. The transition between the internal clock operation mode (DM1-0 = 00) and the VSYNC interface mode becomes effective after displaying one frame made during instruction setting.
5. In the VSYNC interface mode, the partial display, vertical scroll, and interlaced drive functions are not available.
6. In the VSYNC interface mode, set AM to 0 to transmit display data in the aforementioned method.
7. In the VSYNC interface mode, write display data to RAM in the high speed write mode (HWM = 1)

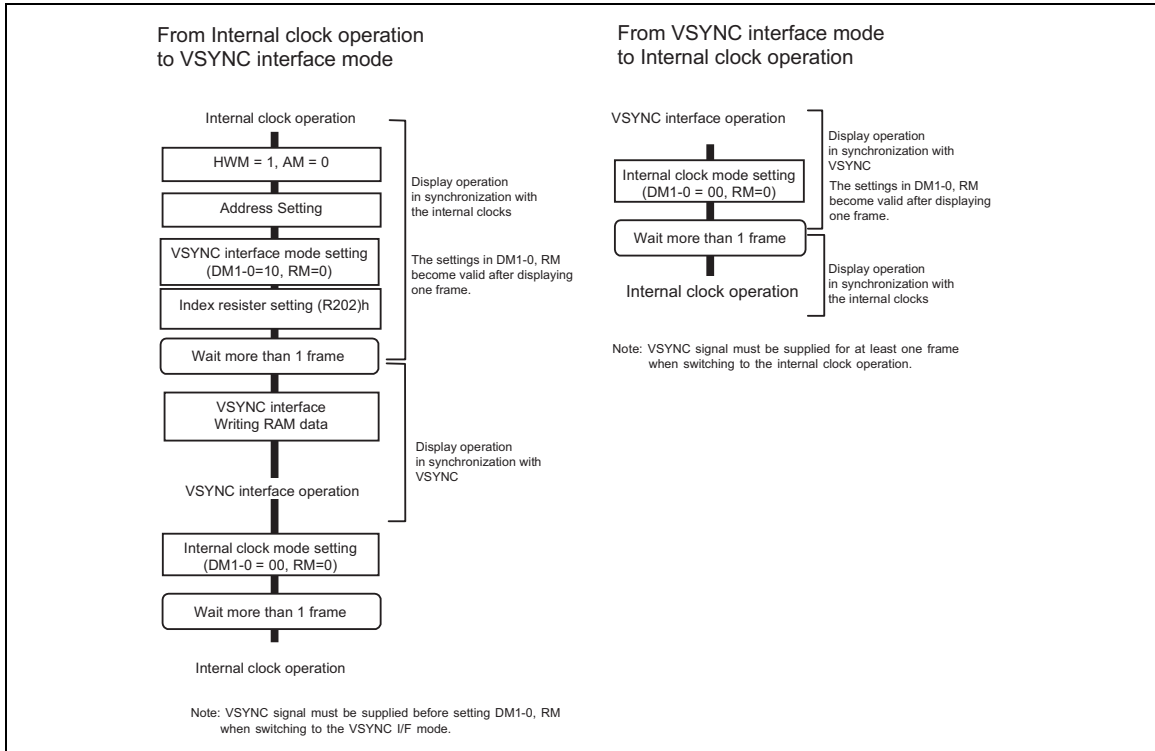

Transition between VSYNC and Internal clock operation modes

External Display Interface

The following interfaces are available as an external display interface (RGB interface). The interface is selected by setting RIM1-0 bits. The RGB interface allows RAM access.

Table 65

RIM1	RIM0	RGB Interface	PD Pin
0	0	18-bit RGB interface	PD17-0
0	1	16-bit RGB interface	PD17-13, 11-1
1	0	6-bit RGB interface	PD17-12
1	1	Setting disabled	-

Note 1) It is not possible to use multiple interfaces at the same time.

Through the RGB-I/F, the display operation is in synchronization with VSYNC, HSYNC, and DOTCLK. The RGB interface enables data transmission in high speed with low power consumption by only overwriting the area that is needed to update in the high-speed write mode in combination with window address function. Front and back porches must be set before and after the display period. Front and back porches must be set before and after the display period.

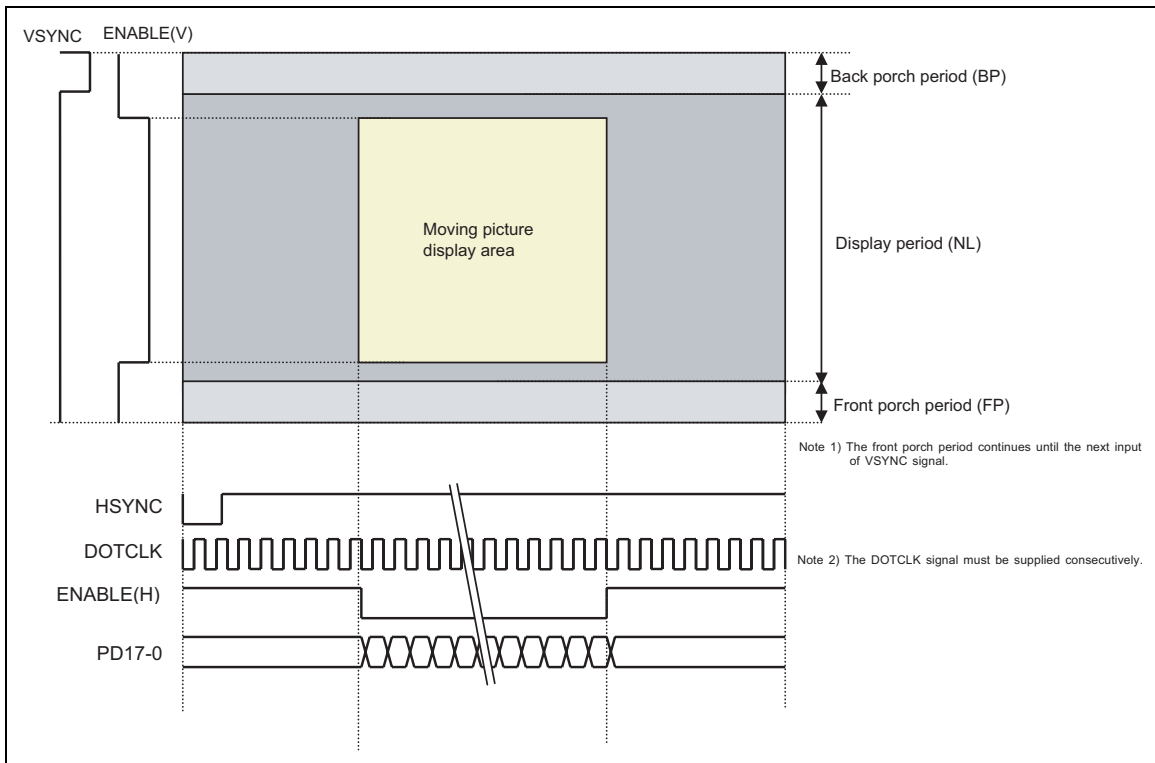

VSYNC: Frame synchronization signal
 HSYNC: Line synchronization signal
 DOTCLK: DOT clock
 ENABLE: Data enable signal
 PD17-0: RGB(6:6:6)display data

Back porch period (BP):
 Front porch period (FP):
 Display Period
 The numbers of raster-rows for 1 frame

$14H \geq BP \geq 2H$
 $14H \geq FP \geq 2H$
 $FP + BP = 16H$
 $NL \leq 320H$
 $FP + NL + BP$

In the RGB interface mode, VSYNC, HSYNC and DOTCLK must be supplied more than to achieve the resolution on the liquid crystal panels.

Polarities of VSYNC, HSYNC, ENABLE, DOTCLK signals

The polarities of VSYNC, HSYNC, ENABLE, DOTCLK signals are changeable by instruction settings (DPL, EPL, HSPL, and VSPL) to conform to the system.

RGB interface timing

Timing chart of signals in 16/18-bit RGB interface mode

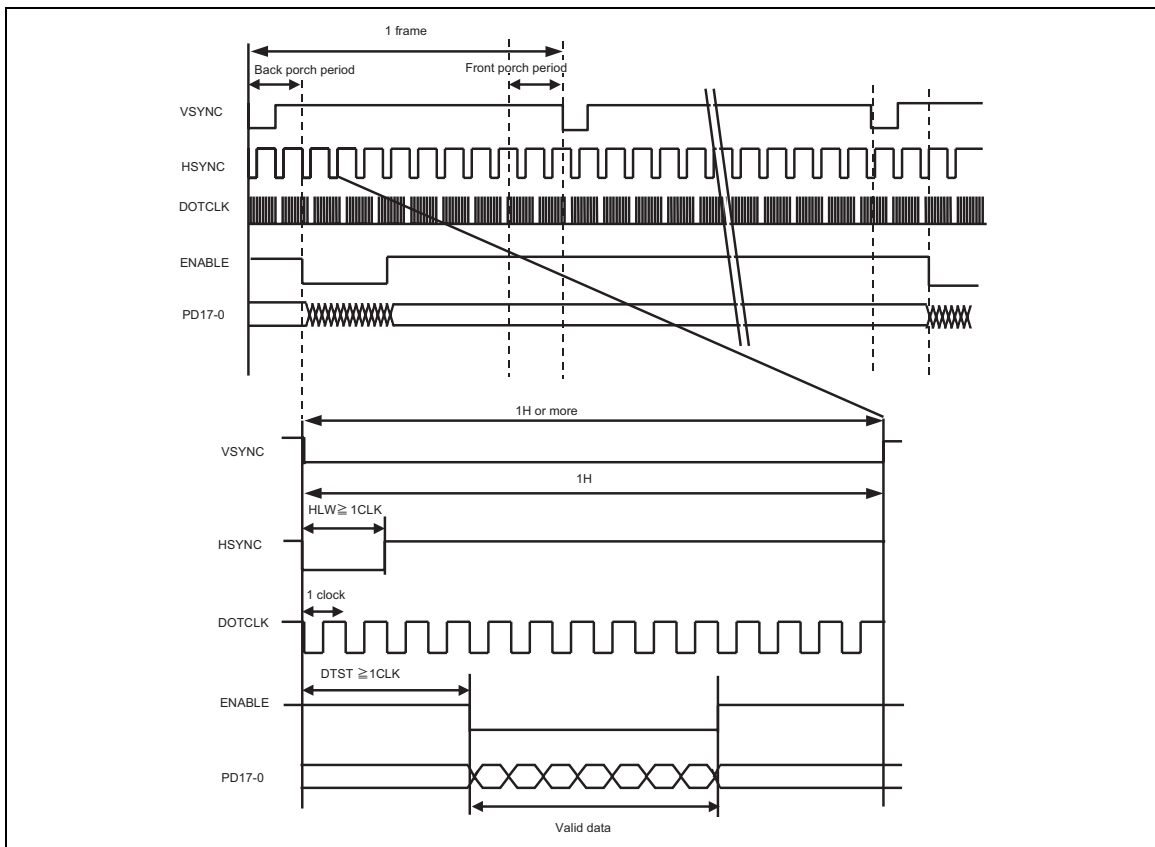

- Note 1) VLW: VSYNC "Low" period
- HLW: HSYNC "Low" period
- DTST: Setup time for data transfer

Note 2) Write data in the high speed write mode (HWM = 1) in the RGB I/F mode.

Timing chart of signals in 6-bit RGB interface mode

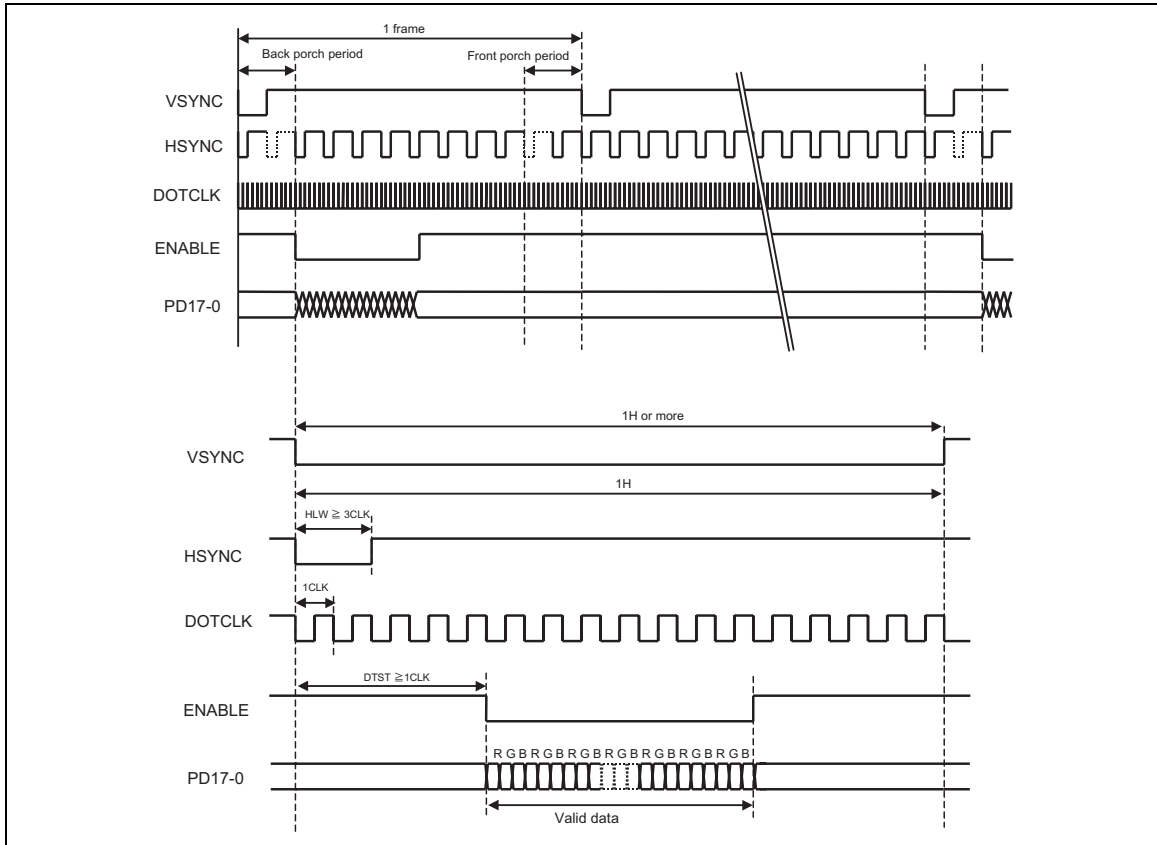

- Note 1) VLW: VSYNC "Low" period
- HLW: HSYNC "Low" period
- DTST: Setup time for data transfer

Note 2) Write data in the high speed write mode (HWM = 1) in the RGB I/F mode.

Note 3) VSYNC, HSYNC, EVABLE, DOTCLK, and PD17-0 must be transmitted by 3 clocks.

Moving picture display in RGB Interface

The HD66781 incorporates the RGB interface to display moving pictures and RAM to store display data, which provides the following merits in displaying moving pictures.

- The window address function enables the transfer of only data for the moving picture area.
- The high-speed write modes enables high-speed access to RAM with low power consumption
- Only transfer data that are written over the moving picture area.
- Reduced transmission contributes to the reduction of power consumption of the entire system.
- In combination with the system interface, the still picture area, such as an icon, can be updated while displaying moving pictures.

RAM access through the system interface in RGB-I/F mode

RAM is accessible through the system interface in the RGB-I/F mode. In the RGB interface mode, data are being written to RAM in synchronization with the DOTCLK input while the ENABLE is “Low”. When writing data to RAM through the system interface, it is necessary to set ENABLE to “High” to stop data write through the RGB-I/F. Setting RM = 0 allows RAM access through the system interface. When reverting to the RGB interface mode, wait a write/read bus cycle. Then, set RM = 1 and the index to R202h to start RAM access through the RGB-I/F. When RAM write through the RGB and system interfaces conflicts, it is not guaranteed that the data are properly written to RAM.

The following is an example of moving picture display through the RGB-I/F and updating still picture area through the system interface.

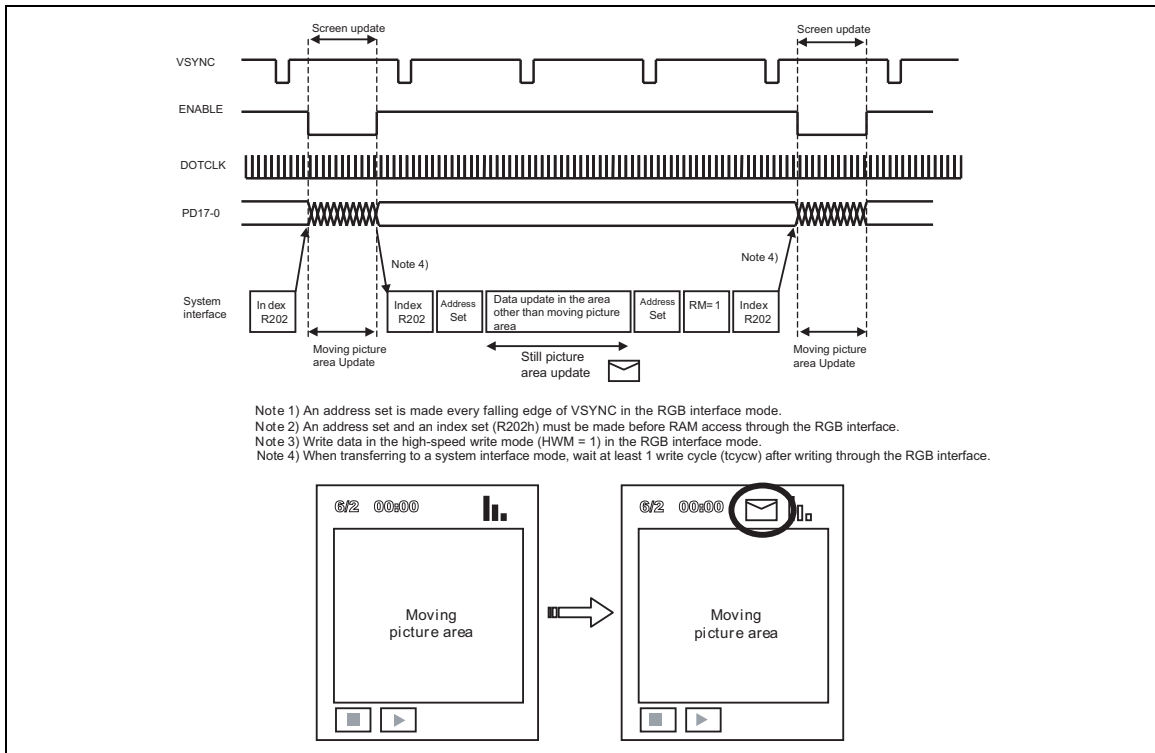

Updating still picture area during moving picture display

6-bit RGB interface

The 6-bit RGB interface is selected by setting RIM1-0 bits to 10. The display operation is synchronized with VSYNC, HSYNC, and DOTCLK signals. Display data are transmitted to RAM in synchronization with the display operation through 6-bit RGB data bus (PD17-12) according to the data enable signal (ENABLE). Unused pins (PD11 to 0) must be fixed to either IOVcc or GND level.

The instructions are set only through the system interface.

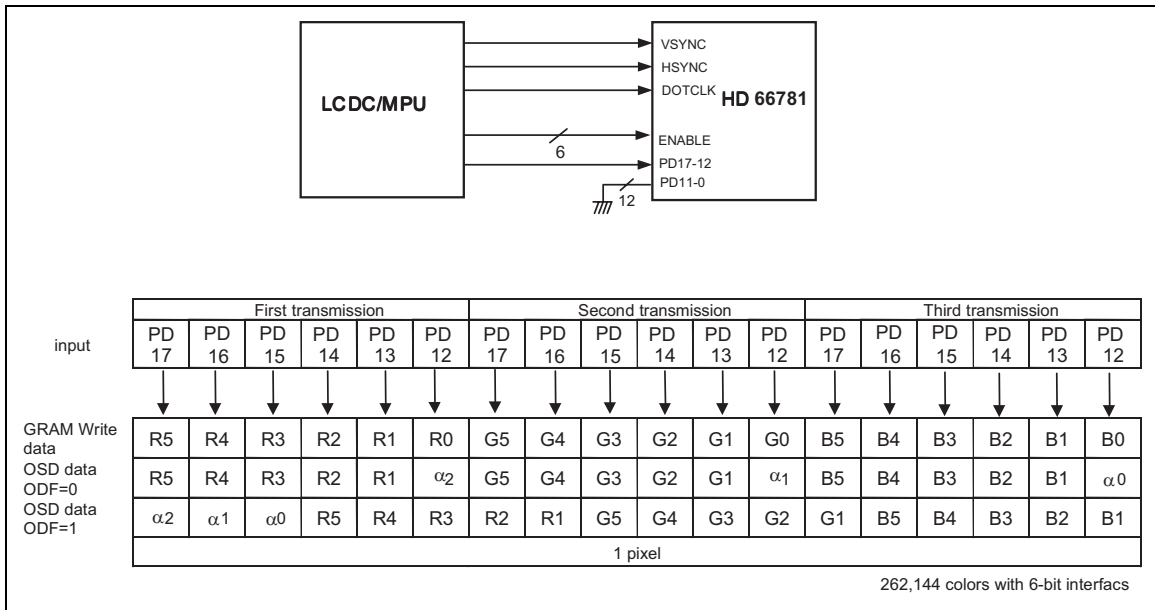

Example of 6-Bit RGB Interface and data format

Transfer synchronization function for a 6-bit bus interface

The HD66781 incorporates a transmission counter to count the first, second, third data transmissions in 6-bit RGB interface mode. The transmission counter is always reset to the first transmission on the falling edge of the VSYNC. When a discrepancy occurs in the transmission of first, second and third data, the counter is reset to the first data transmission at the start of each frame (the falling edge of VSYNC) and the data transmission restarts in the correct order from the next frame. In case of displaying moving pictures, which requires consecutive data transfer, this function minimizes the effect from the discrepancy in the data transmission and facilitates to return to the normal display.

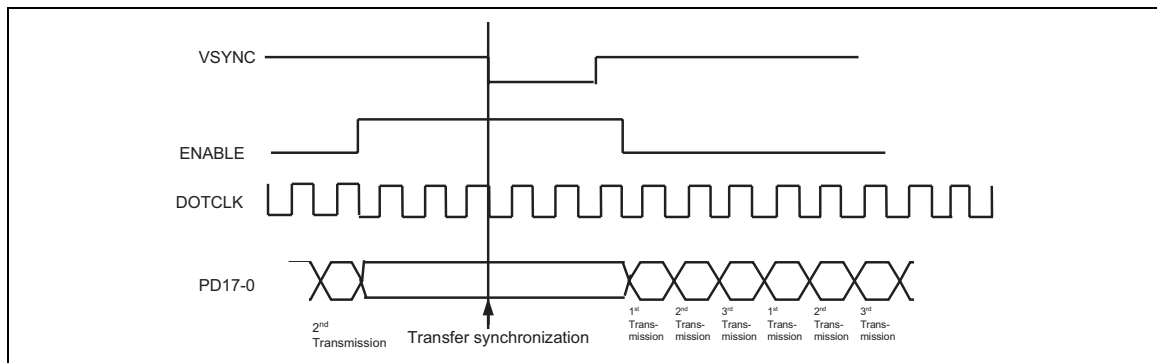

6-bit Transfer Synchronization

16-bit RGB interface

The 16-bit RGB interface is selected by setting RIM1-0 bits to 01. The display operation is synchronized with VSYNC, HSYNC, and DOTCLK signals. Display data are transmitted to RAM in synchronization with the display operation through 16-bit RGB data bus (PD17-13, 11-1) according to the data enable signal (ENABLE).

The instructions are set only through the system interface.

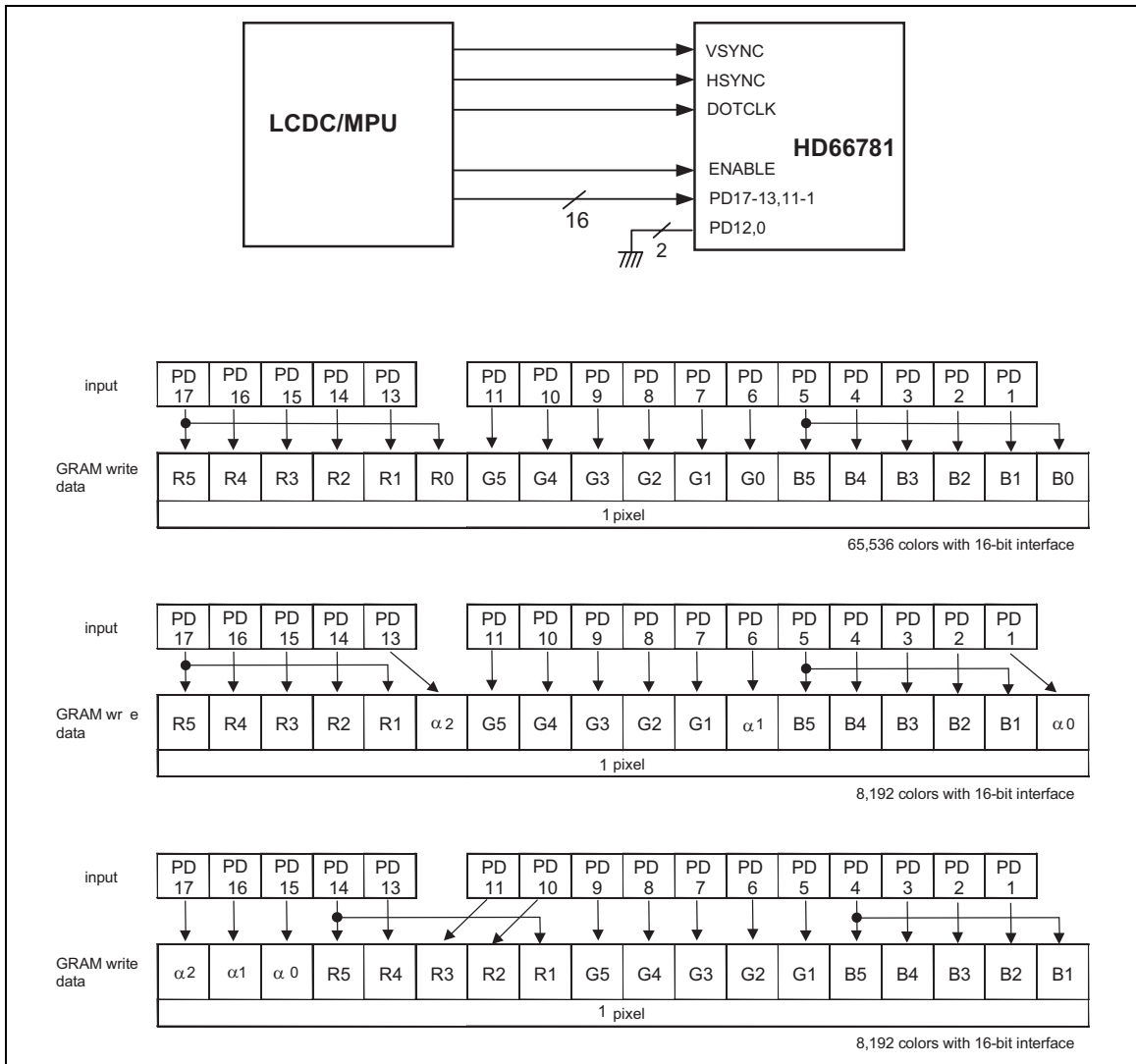

Example of 16-Bit RGB Interface and data format

18-bit RGB interface

The 18-bit RGB interface is selected by setting RIM1-0 bits to 10. The display operation is synchronized with VSYNC, HSYNC, and DOTCLK signals. Display data are transmitted to RAM in synchronization with the display operation through 18-bit RGB data bus (PD17-0) according to the data enable signal (ENABLE).

The instructions are set only through the system interface.

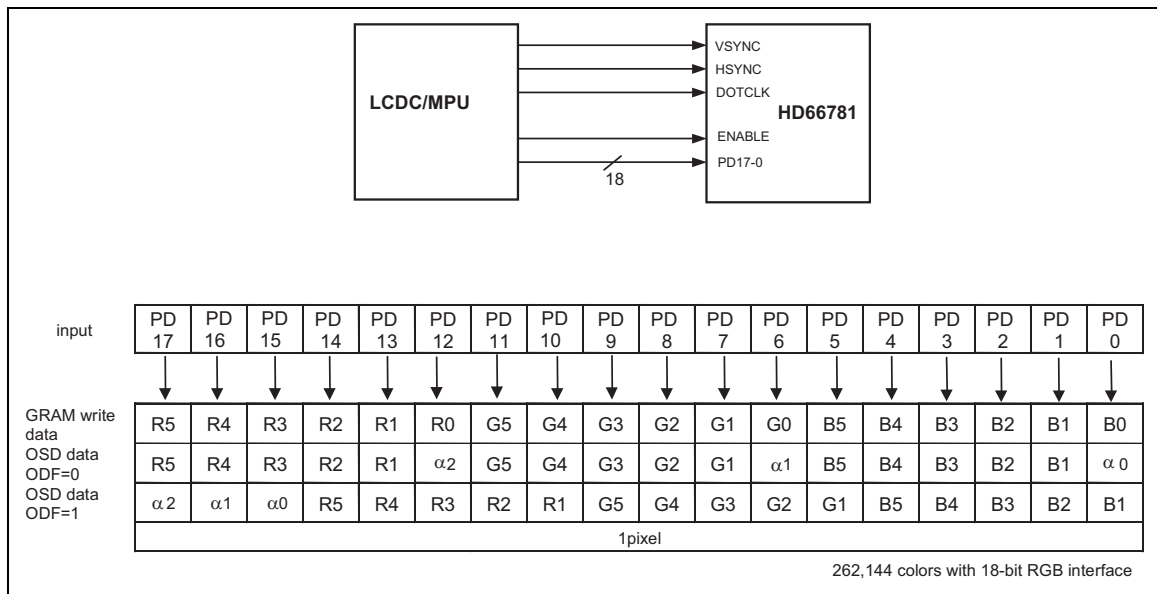

Example of 18-Bit RGB Interface and data format

Notes to the external display interface

1. While an external display interface is selected, the following functions are not available.

Table 66

Function	External Display Interface	Internal Display Operation
Partial display	Not available	Available
Scroll function	Not available	Available
Interlaced drive	Not available	Available

- The VSYNC, HSYNC, and DOTCLK signals must be supplied through the display operation through the RGB-I/F.
- When making settings for gate driver/LTPS panel controlling signal in the RGB-I/F modes, the reference clock is DOTCLK, not the internal operation clocks.
- In the 6-bit RGB-I/F mode, the RGB (pixels) data are transmitted by three clocks.
- In the 6-bit RGB-I/F mode, the interface signals, VSYNC, HSYNC, DOTCLK, ENABLE, and PD17-0, should be set by RGB (pixels) unit in convenience for the transmitting RGB pixels.
- The transitions between the internal operation mode and external display interface should be made according to the mode switching sequence below.
- In the RGB-I/F mode, the front porch period continues after displaying one frame data until the next VSYNC signal input.
- In the RGB-I/F mode, the data must be written in the high-speed write mode (HWM = 1).
- In the RGB-I/F mode, the address is set every frame on the falling edge of VSYNC.

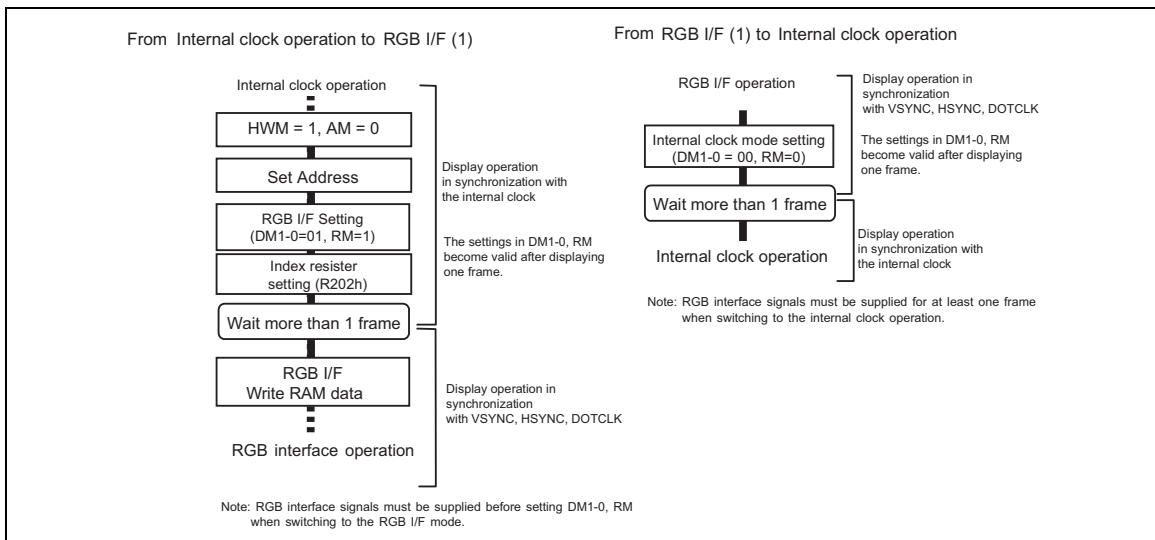

Display Synchronizing Data Transfer

The HD66781 outputs BST signal that indicates the start of vertical retrace line period for flicker-free screen update. The BST signal is used as trigger to start internal GRAM write so that data transfer is synchronized with display scan.

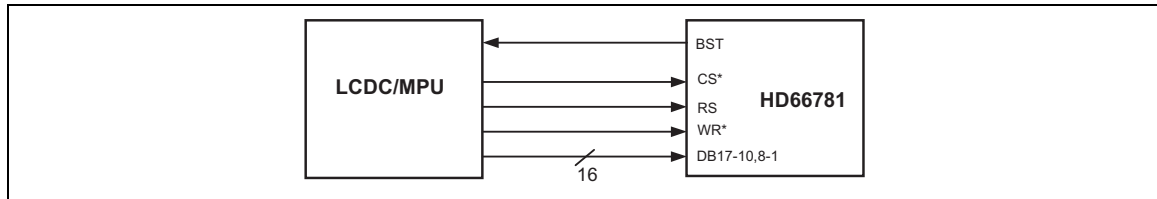

Display synchronizing data transfer: Interface example

By writing data to RAM through the system interface in a speed that is higher for more than a fixed speed than the internal display operation speed, it enables moving picture display through an conventional interface and flicker-free screen update.

All display data are stored in RAM. Therefore, it only requires transfer of the data that is written over to update the screen, thereby minimizing the numbers of data transfers while displaying moving picture. The use of high-speed write mode (HWM = 1) with VSYNC interface enables RAM access in high speed with low power consumption.

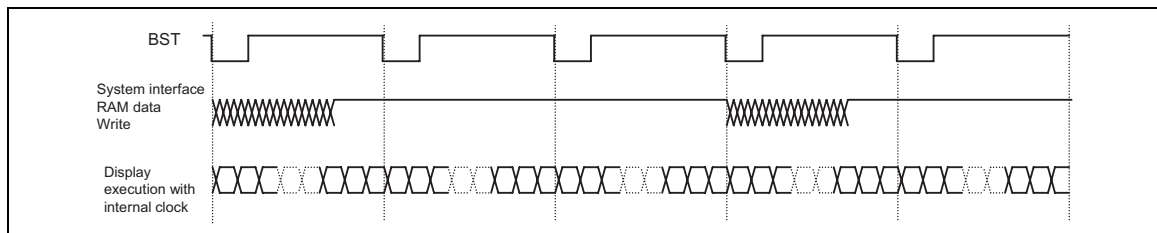

Moving picture data transmission through VSYNC interface

Note 1) Data must be written to RAM in the high-speed write mode (HWM = 1) in VSYNC interface mode.

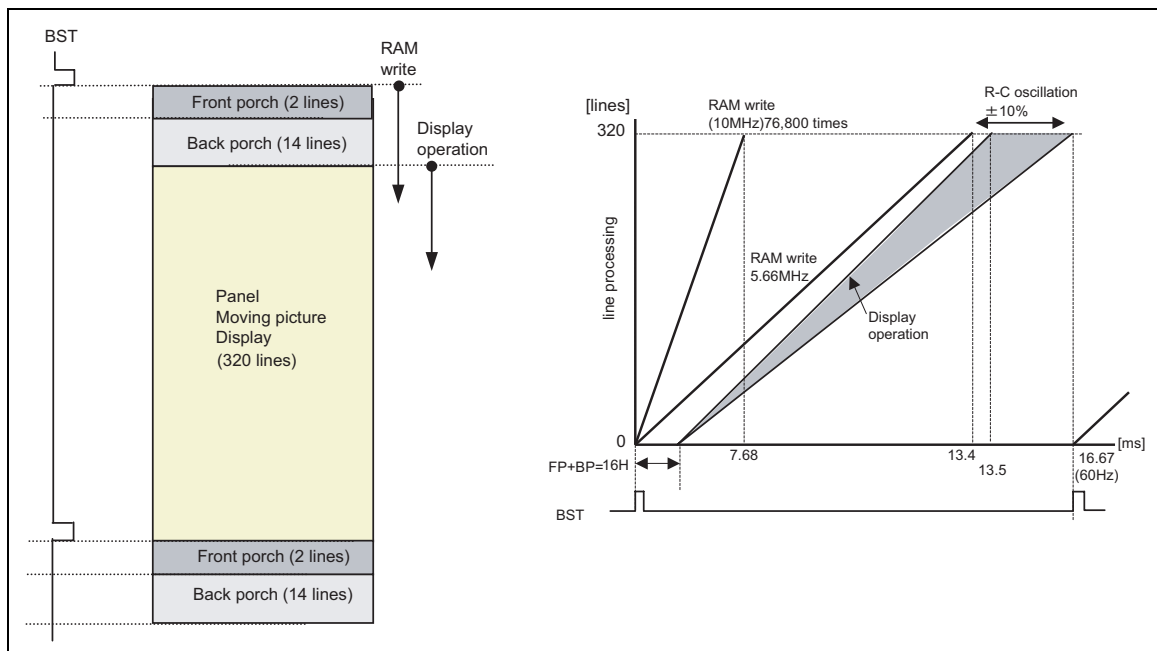

Minimum RAM write speed and internal clock frequency in VSYNC interface

Notes to the display synchronizing GRAM data transfer mode

1. The aforementioned example of calculation is just a result of calculation. In the actual settings, causes for the fluctuations such as internal oscillators and so on should be taken into consideration. It is necessary to make a setting for RAM write speed with enough margins.
2. In the display synchronizing GRAM data transfer mode, write display data to RAM in the high speed write mode (HWM = 1)

Timing interfacing with LCD panel signals

The relationship between RGB I/F signals and LCD panel signals during internal operation is as follows.

Timing interfacing with liquid crystal panel signals in RGB interface mode

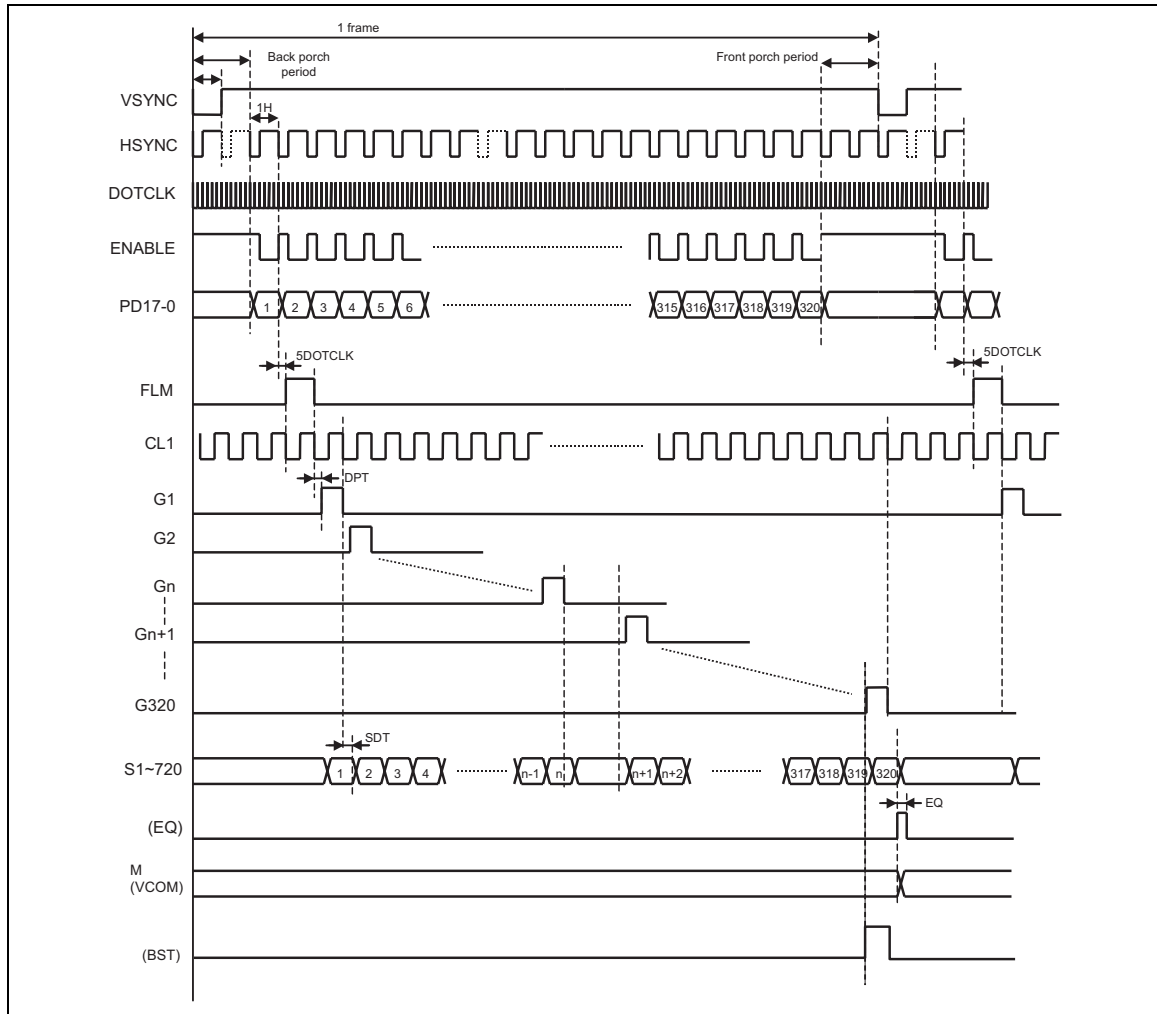

Note 1) This figure is the example when DIVE[1:0] = 2'h2

Timing interfacing with liquid crystal panel signals in internal clock operation mode

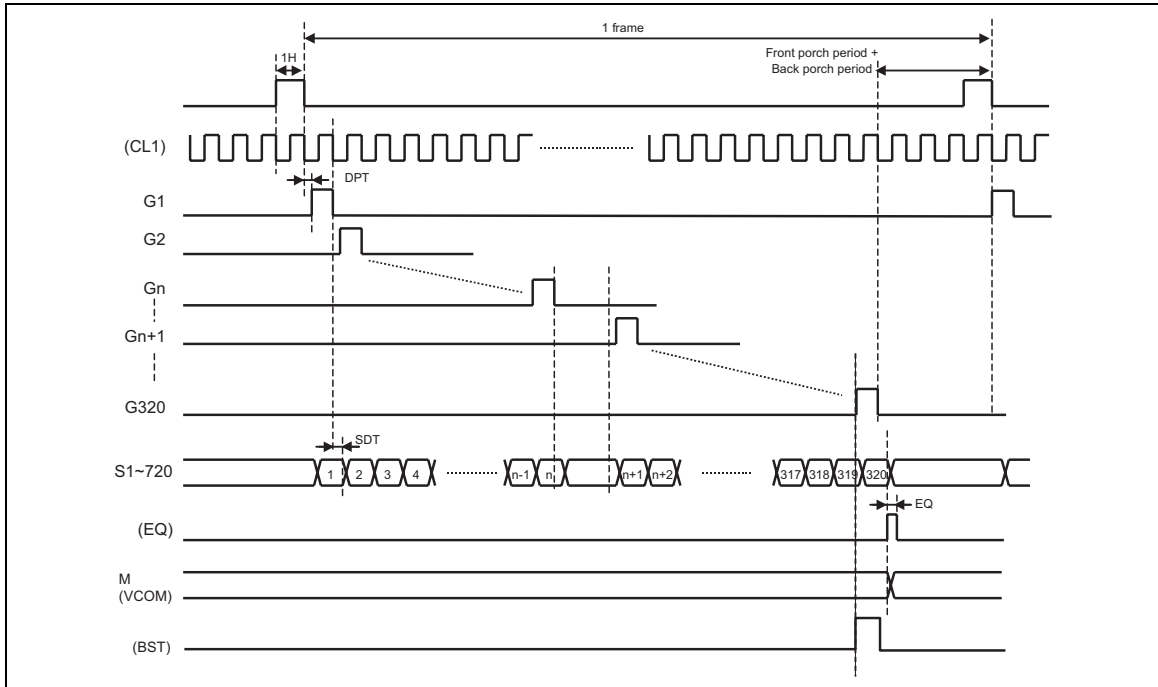

High-Speed Burst RAM Write Function

The HD66781 incorporates high-speed burst RAM-write function, which writes data to RAM about half the time required for the normal RAM write. This function is especially useful for applications, which require high-speed display data rewrite, such as colored moving picture display and so on.

In the high-speed RAM-write mode (HWM=1), data to write to RAM is temporarily stored to the internal register of HD66781 and then written to RAM by horizontal line in the area specified by the window address. Since the data stored in the register are written to RAM at once, it is possible to write next data to the internal register while data are being written from the internal register to RAM. This reduces the frequency of RAM access to minimum and enables consecutive high-speed access to the internal RAM with low power consumption, which is required for moving picture display.

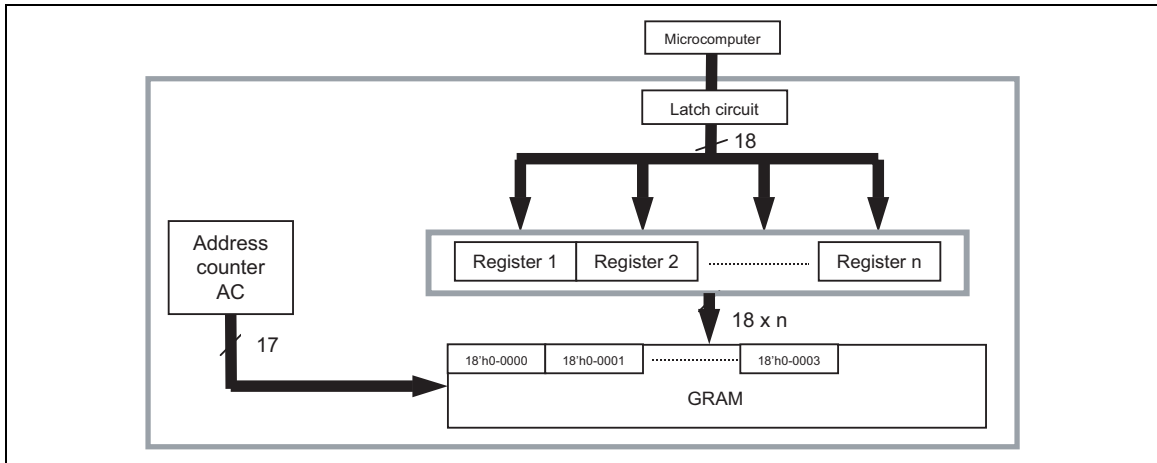

High-speed consecutive access to RAM, operational flow

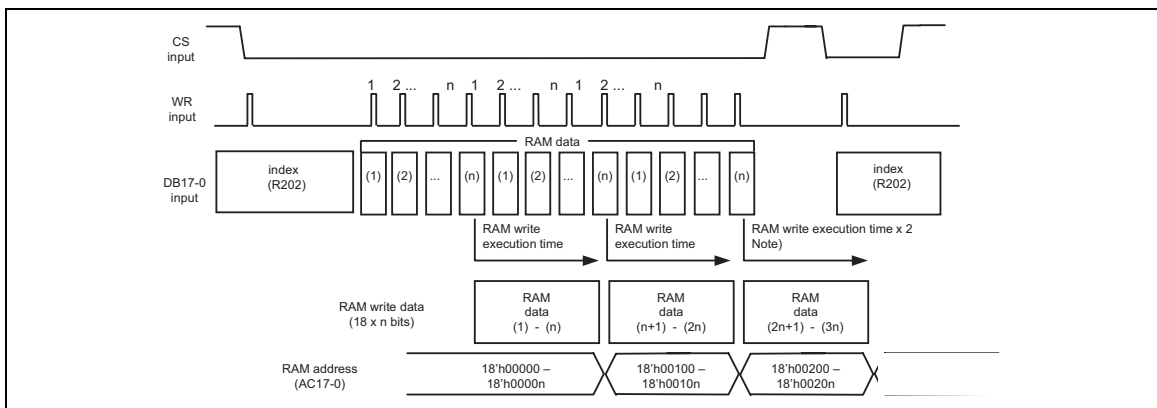

High-speed consecutive access to RAM (HWM = "1")

Note 1) When making a transition from the high-speed RAM write to the index write, wait at least 2 bus cycle time (t_{cyw}) in the normal write mode after RAM write before executing next instructions.

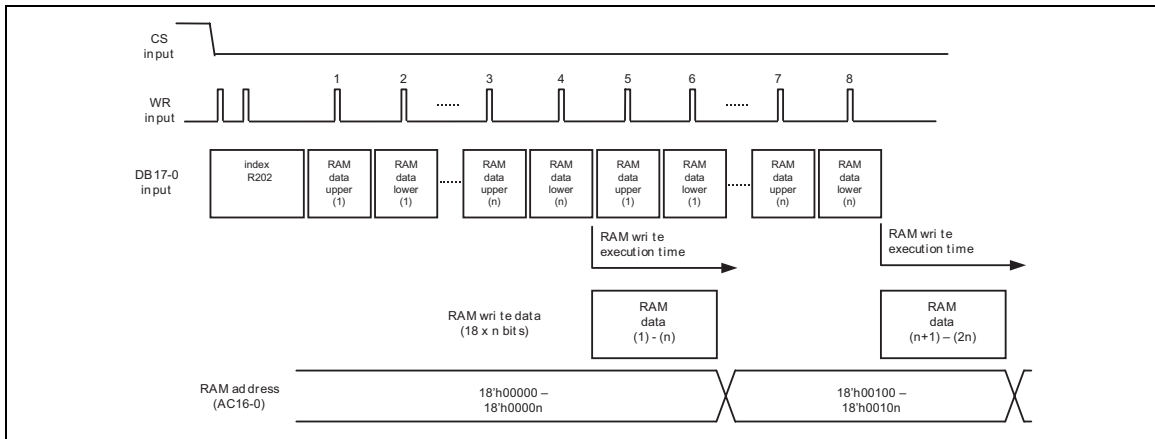

High-speed consecutive access to RAM (9-bit interface)

Note 1) The high-speed RAM write mode (HWM=1) writes data to RAM by n words. In the 9-bit interface mode, data are written to RAM 2xn times per line.

Notes to the high-speed RAM write mode

1. RAM write is executed by line. If write operation is terminated before it reaches the end of horizontal line of the window-address area, it is not guaranteed that data are properly written on that line.
2. The index register for the RAM data write (202H), if selected, executes the first data write operation. This setting does not allow RAM data read. HWM must be set to 0 during RAM read.
3. The high-speed RAM write mode is not compatible with the normal RAM write mode. Whenever switching to the other mode, it is necessary to set the address before starting RAM write.

Table 67

	Normal RAM Write (HWM=0)	High-Speed RAM Write (HWM=1)
BGR function	Available	Available
Write mask function	Available	Available
RAM address set	Set by words	Set by words
RAM read	Set by words	Not available
RAM write	Set by words	Set by lines
Window address	Set by words (minimum range: 1 word x 1 line)	Set by words (minimum range: 8 word x 1 line)
External display interface	Available	Available
AM	AM = 1/0	AM = 0

High-Speed RAM Write with Window Address Function

Specifying a window-address range (minimum range: 8 words x 1 word) enables consecutive high-speed RAM data write in an arbitrary rectangular area on RAM.

In the high-speed write mode, data must be written to RAM by horizontal lines. If RAM write is terminated in the middle of the line, there is no guarantee that data are properly written on that line.

The following figure illustrates an example of high-speed RAM write in the window-address range on RAM.

By setting the window address specifying bits (HSA = 8'h10, HEA = 8'h2F, VSA = 9'h020, VEA = 9'h05F), data are written consecutively in high speed in the window-address range specified by these bits.

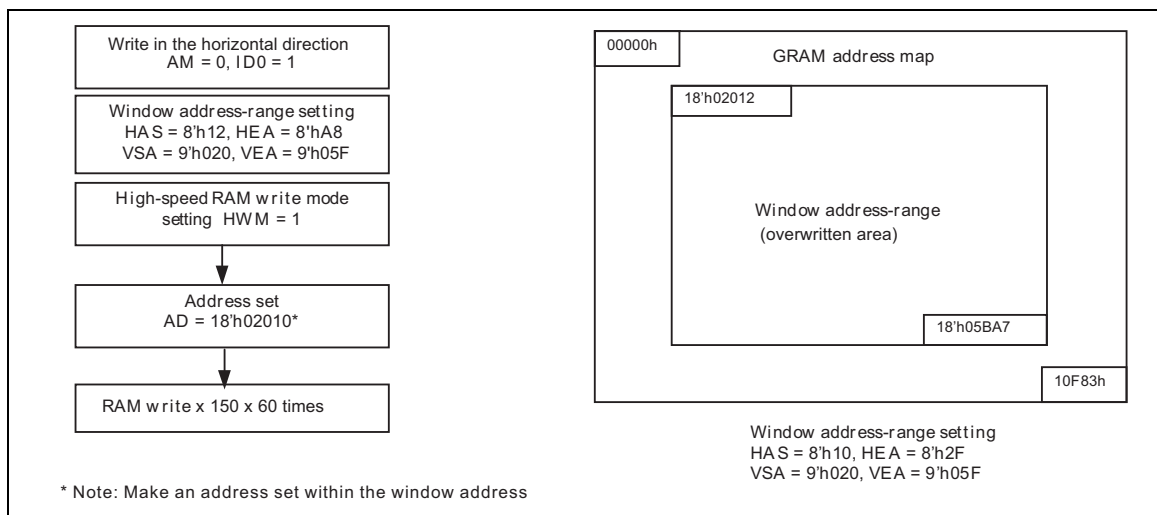

Window Address Function

The window address function writes data consecutively to the on-chip GRAM within the rectangular window-address range specified by the horizontal address registers (start: HSA7-0, end: HEA 7-0) and the vertical address registers (start: VSA7-0, end: VEA7-0).

The address transition direction is determined by AM bit (either increment or decrement). This allows writing data, including picture data, consecutively without taking the data wrap position into consideration.

The window-address range must be specified within the GRAM address area. An address set must be made within the window-address range.

[Conditions on setting window-address range]

(horizontal direction) $8'h00 \leq HSA \leq HEA \leq 8'hEF$
 (vertical direction) $9'h000 \leq VSA \leq VEA \leq 9'h19F$

[Conditions on making an address set within the window-address range]

(RAM address) $HSA \leq AD7-0 \leq HEA$
 $VSA \leq AD16-8 \leq VEA$

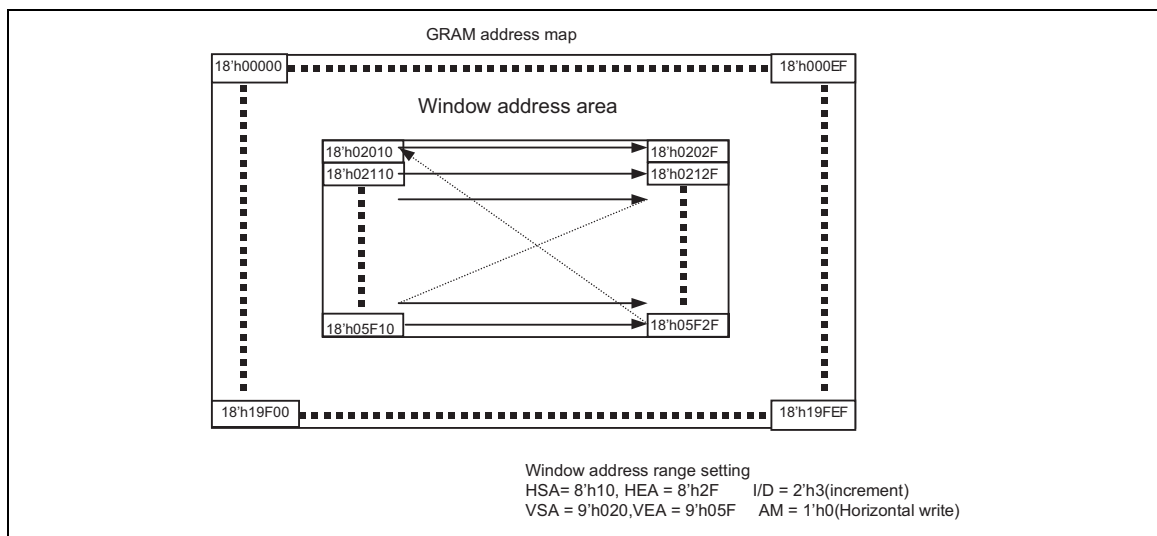

Address transition direction in specified window-address range

γ-Correction Function

The HD66781 incorporates γ-correction function to simultaneously display 262,144 colors, by which 8-level grayscale is determined by the gradient-adjustment and fine-adjustment registers. The HD66781 incorporates gradient-adjustment and fine-adjustment registers for both positive and negative polarities and allows selecting either positive or negative polarity according to the characteristics of a liquid crystal panel.

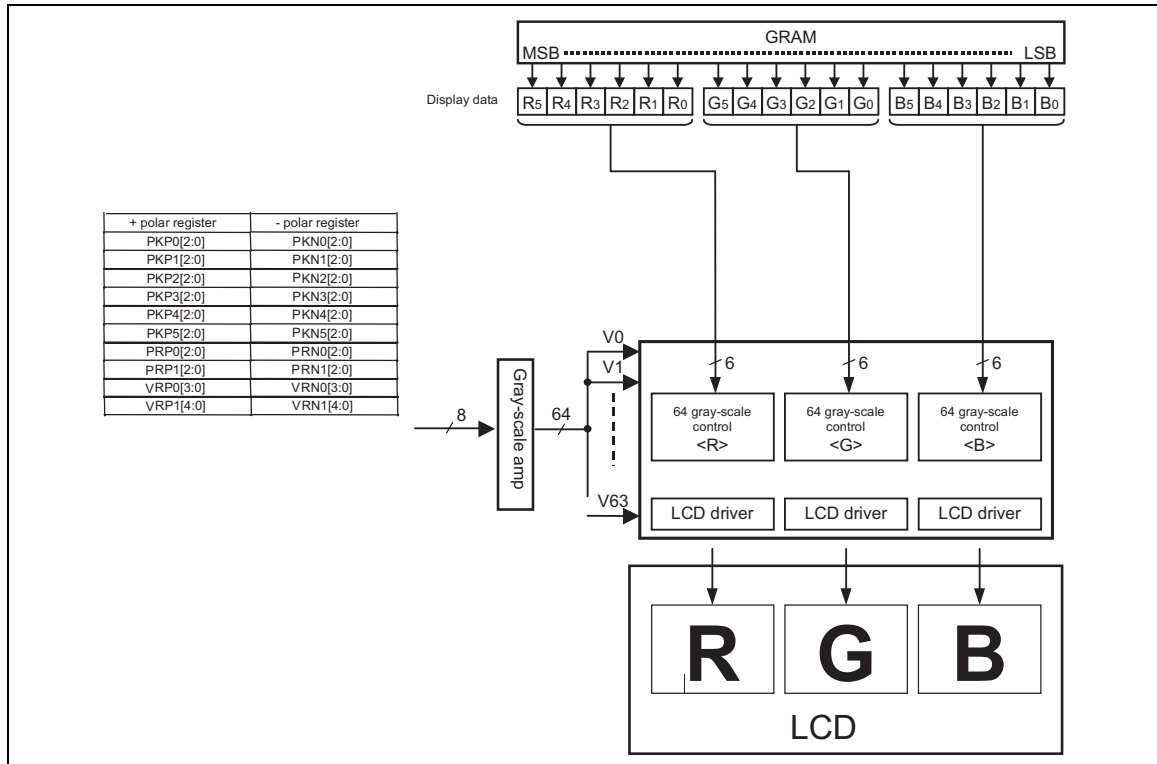

Grayscale control

Grayscale Amplifier Configuration

The following figure illustrates the configuration of grayscale amplifier.

The eight-level grayscales (VIN0-7) are determined by the gradient adjustment and fine adjustment registers. The 8 levels are then divided by the ladder resistors placed between each level into 64 levels (V0-63).

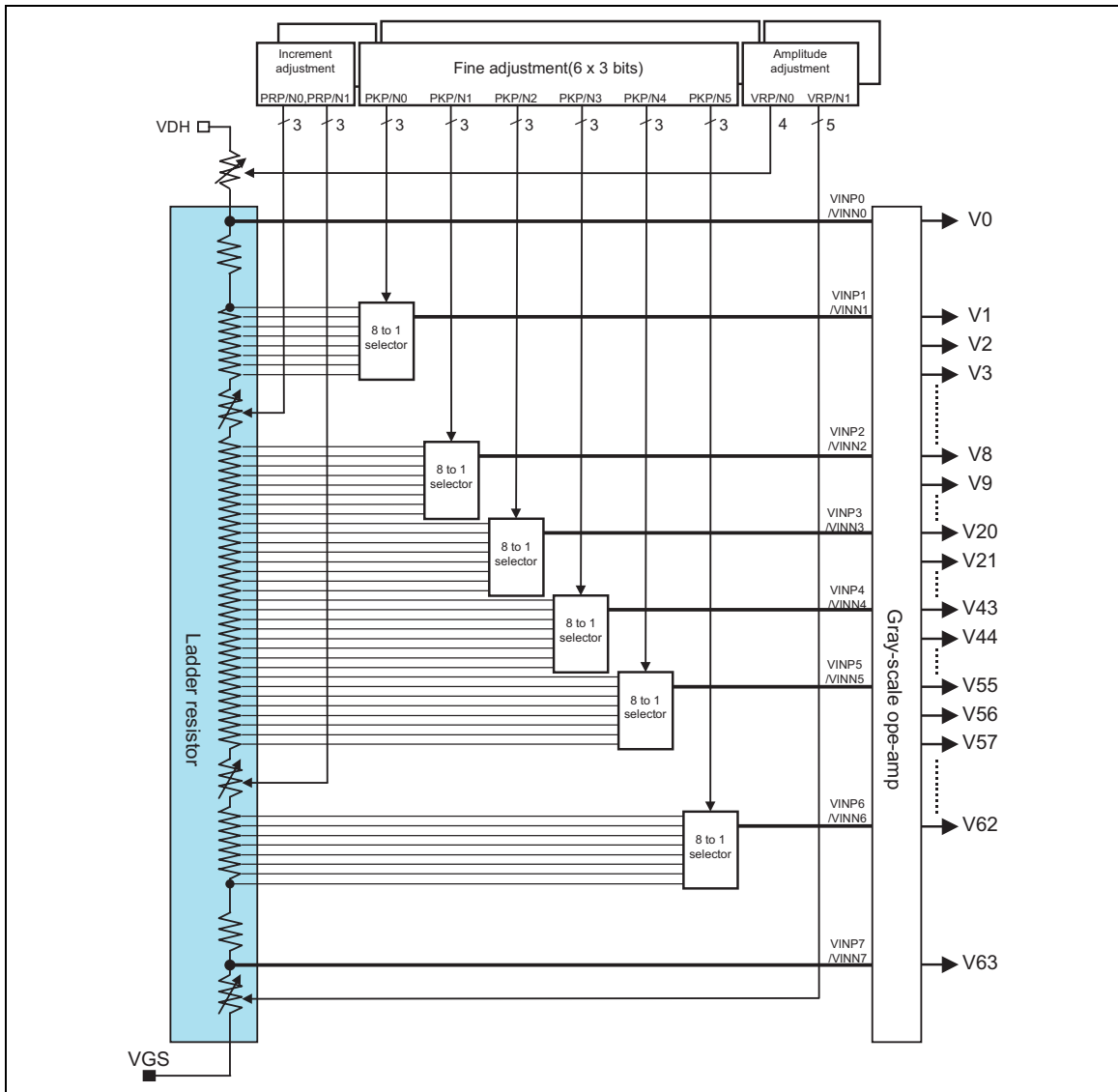

Grayscale amplifier

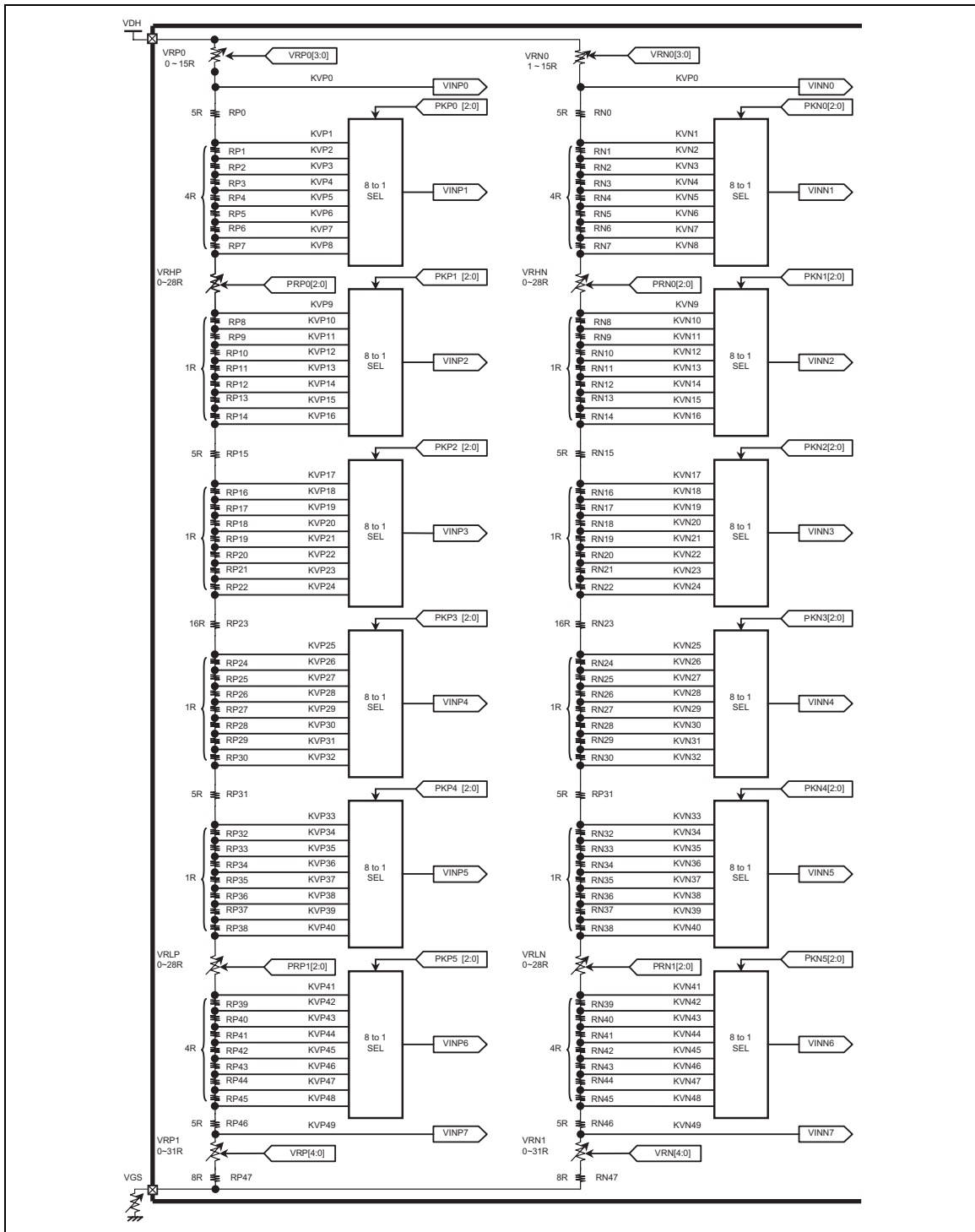

Ladder Resistors and 8 to 1 Selectors

γ -Correction Registers

The γ -adjustment register is a group of registers to set an appropriate grayscale voltage for the γ -characteristics of a liquid crystal panel. The register group is categorized into the ones adjusting gradient, amplitude, and reference value and fine-tuning in relation to grayscale number and grayscale voltage characteristics. Each register group can make an independent setting for the positive/negative polarity. The reference value and RGB are common to both polarities.

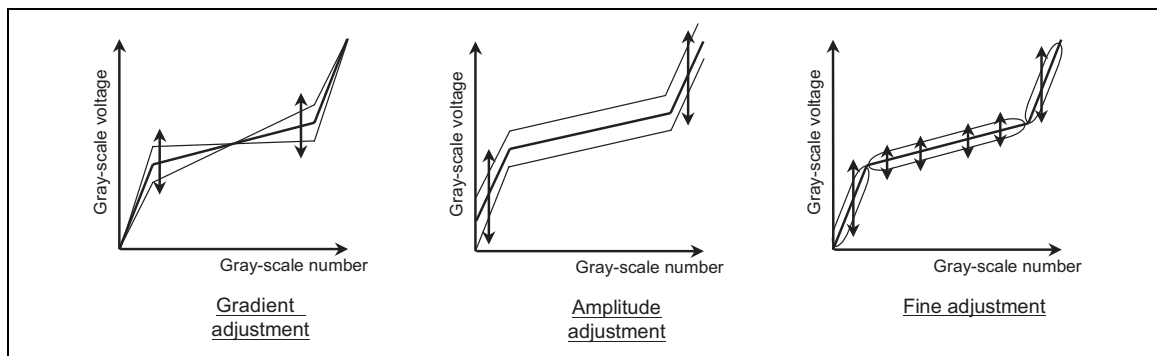

Gradient, Amplitude, Fine Adjustments

1. Gradient adjustment registers

The gradient adjustment registers are used to adjust the gradient around the middle of the grayscale number and voltage characteristics without changing a dynamic range. To adjust a gradient, the values of the variable resistors (VRHP (N)/VRLP (N)) in the ladder resistor block for grayscale voltage generation are controlled. The registers incorporate separate registers for positive and negative polarities to be compatible with asymmetric drive.

2. Amplitude adjustment registers

The amplitude adjustment registers are used to adjust the amplitude of the grayscale voltage. To adjust the amplitude, the values of the variable resistors (VRP(N)1/0) in the upper and lower parts of the ladder resistor block for grayscale voltage generation are adjusted. Same with the gradient registers, the amplitude adjustment registers also incorporate separate registers for positive and negative polarities.

3. Fine adjustment registers

The fine adjustment register is to fine-adjust the grayscale voltage level. To fine-adjust the grayscale voltage level, 8-to-1 selectors control each level of 8-level reference voltages generated from the ladder registers. Same with the other registers, the fine adjustment registers also incorporate separate registers for positive and negative polarities.

Table 68 List of output signals

Register Groups	Positive Polarity	Negative Polarity	Description
Gradient adjustment	PRP0 [2:0]	PRN0 [2:0]	Variable resistor VRHP (N)
	PRP1 [2:0]	PRN1 [2:0]	Variable resistor VRLP (N)
Amplitude adjustment	VRP0 [3:0]	VRN0 [3:0]	Variable resistor VRP (N) 0
	VRP1 [4:0]	VRN1 [4:0]	Variable resistor VRP (N) 1
Fine adjustment	PKP0 [2:0]	PKN0 [2:0]	8-to-1 selector (voltage level of grayscale 1)
	PKP1 [2:0]	PKN1 [2:0]	8-to-1 selector (voltage level of grayscale 8)
	PKP2 [2:0]	PKN2 [2:0]	8-to-1 selector (voltage level of grayscale 20)
	PKP3 [2:0]	PKN3 [2:0]	8-to-1 selector (voltage level of grayscale 43)
	PKP4 [2:0]	PKN4 [2:0]	8-to-1 selector (voltage level of grayscale 55)
	PKP5 [2:0]	PKN5 [2:0]	8-to-1 selector (voltage level of grayscale 62)

Ladder resistors and 8 to 1 selector

Block configuration

The block configuration of page 159 consists of two ladder resistors including variable resistors, and 8 to 1 selectors, which select the voltage generated by the ladder resistors, to output the reference voltage for the grayscale voltage. The γ -correction registers control the variable resistors and the 8 to 1 selectors. Pins that are connected to a variable resistor are also provided to compensate the variation among the panels.

Variable resistors

There are three kinds of variable resistors for the gradient adjustment (VRHP(N)/VRLP(N)), the amplitude adjustment (VRP(N)), and the reference adjustment (VDR). The resistance is determined by the gradient adjustment and amplitude adjustment registers as is shown below.

Table 69

Gradient adjustment		Amplitude adjustment		Reference adjustment	
Register PRP(N)0/1[2:0]	Resistance VRHP(N) VRLP(N)	Register VRP(N)0[3:0]	Resistance VRP(N)0	Register VRP(N)1[4:0]	Resistance VRP(N)1
000	0R	0000	0R	00000	0R
001	4R	0001	1R	00001	1R
010	8R	0010	2R	00010	2R
011	12R	:	:	:	:
100	16R	:	:	:	:
101	20R	1101	13R	11101	29R
110	24R	1110	14R	11110	30R
111	28R	1111	15R	11111	31R

8 to 1 selector

The 8-to-1 selectors select a voltage level generated by the ladder resistors according to the fine adjustment registers, and output as a reference voltage of either one of the following VIN1 ~ VIN 6. The relationship between the fine adjustment register and the selected voltage is as follows

Table 70

Contents of Register PKP(N) 0/1 [2:0]	Selected Voltage					
	VINP(N)1	VINP(N)2	VINP(N)3	VINP(N)4	VINP(N)5	VINP(N)6
000	KVP(N)1	KVP(N)9	KVP(N)17	KVP(N)25	KVP(N)33	KVP(N)41
001	KVP(N)2	KVP(N)10	KVP(N)18	KVP(N)26	KVP(N)34	KVP(N)42
010	KVP(N)3	KVP(N)11	KVP(N)19	KVP(N)27	KVP(N)35	KVP(N)43
011	KVP(N)4	KVP(N)12	KVP(N)20	KVP(N)28	KVP(N)36	KVP(N)44
100	KVP(N)5	KVP(N)13	KVP(N)21	KVP(N)29	KVP(N)37	KVP(N)45
101	KVP(N)6	KVP(N)14	KVP(N)22	KVP(N)30	KVP(N)38	KVP(N)46
110	KVP(N)7	KVP(N)15	KVP(N)23	KVP(N)31	KVP(N)39	KVP(N)47
111	KVP(N)8	KVP(N)16	KVP(N)24	KVP(N)32	KVP(N)40	KVP(N)48

The gray scale levels (V0-V63) are calculated according to the following formulas.

Formulas for calculating voltage (Positive polarity) (1)

Pins	Formula	Fine-adjustment registers	Reference voltage
KVP0	VDH- $V^*VxP0/SUMRP$	-	VINP0
KVP1	VDH- $V^*(VxRP0+5R)/SUMRP$	PKP0[2:0]="000"	VINP1
KVP2	VDH- $V^*(VxRP0+9R)/SUMRP$	PKP0[2:0]="001"	
KVP3	VDH- $V^*(VxRP0+13R)/SUMRP$	PKP0[2:0]="010"	
KVP4	VDH- $V^*(VxRP0+17R)/SUMRP$	PKP0[2:0]="011"	
KVP5	VDH- $V^*(VxRP0+21R)/SUMRP$	PKP0[2:0]="100"	
KVP6	VDH- $V^*(VxRP0+25R)/SUMRP$	PKP0[2:0]="101"	
KVP7	VDH- $V^*(VxRP0+29R)/SUMRP$	PKP0[2:0]="110"	
KVP8	VDH- $V^*(VxRP0+33R)/SUMRP$	PKP0[2:0]="111"	
KVP9	VDH- $V^*(VxRP0+33R+VRHP)/SUMRP$	PKP1[2:0]="000"	VINP2
KVP10	VDH- $V^*(VxRP0+34R+VRHP)/SUMRP$	PKP1[2:0]="001"	
KVP11	VDH- $V^*(VxRP0+35R+VRHP)/SUMRP$	PKP1[2:0]="010"	
KVP12	VDH- $V^*(VxRP0+36R+VRHP)/SUMRP$	PKP1[2:0]="011"	
KVP13	VDH- $V^*(VxRP0+37R+VRHP)/SUMRP$	PKP1[2:0]="100"	
KVP14	VDH- $V^*(VxRP0+38R+VRHP)/SUMRP$	PKP1[2:0]="101"	
KVP15	VDH- $V^*(VxRP0+39R+VRHP)/SUMRP$	PKP1[2:0]="110"	
KVP16	VDH- $V^*(VxRP0+40R+VRHP)/SUMRP$	PKP1[2:0]="111"	
KVP17	VDH- $V^*(VxRP0+45R+VRHP)/SUMRP$	PKP2[2:0]="000"	VINP3
KVP18	VDH- $V^*(VxRP0+46R+VRHP)/SUMRP$	PKP2[2:0]="001"	
KVP19	VDH- $V^*(VxRP0+47R+VRHP)/SUMRP$	PKP2[2:0]="010"	
KVP20	VDH- $V^*(VxRP0+48R+VRHP)/SUMRP$	PKP2[2:0]="011"	
KVP21	VDH- $V^*(VxRP0+49R+VRHP)/SUMRP$	PKP2[2:0]="100"	
KVP22	VDH- $V^*(VxRP0+50R+VRHP)/SUMRP$	PKP2[2:0]="101"	
KVP23	VDH- $V^*(VxRP0+51R+VRHP)/SUMRP$	PKP2[2:0]="110"	
KVP24	VDH- $V^*(VxRP0+52R+VRHP)/SUMRP$	PKP2[2:0]="111"	
KVP25	VDH- $V^*(VxRP0+68R+VRHP)/SUMRP$	PKP3[2:0]="000"	VINP4
KVP26	VDH- $V^*(VxRP0+69R+VRHP)/SUMRP$	PKP3[2:0]="001"	
KVP27	VDH- $V^*(VxRP0+70R+VRHP)/SUMRP$	PKP3[2:0]="010"	
KVP28	VDH- $V^*(VxRP0+71R+VRHP)/SUMRP$	PKP3[2:0]="011"	
KVP29	VDH- $V^*(VxRP0+72R+VRHP)/SUMRP$	PKP3[2:0]="100"	
KVP30	VDH- $V^*(VxRP0+73R+VRHP)/SUMRP$	PKP3[2:0]="101"	
KVP31	VDH- $V^*(VxRP0+74R+VRHP)/SUMRP$	PKP3[2:0]="110"	
KVP32	VDH- $V^*(VxRP0+75R+VRHP)/SUMRP$	PKP3[2:0]="111"	
KVP33	VDH- $V^*(VxRP0+80R+VRHP)/SUMRP$	PKP4[2:0]="000"	VINP5
KVP34	VDH- $V^*(VxRP0+81R+VRHP)/SUMRP$	PKP4[2:0]="001"	
KVP35	VDH- $V^*(VxRP0+82R+VRHP)/SUMRP$	PKP4[2:0]="010"	
KVP36	VDH- $V^*(VxRP0+83R+VRHP)/SUMRP$	PKP4[2:0]="011"	
KVP37	VDH- $V^*(VxRP0+84R+VRHP)/SUMRP$	PKP4[2:0]="100"	
KVP38	VDH- $V^*(VxRP0+85R+VRHP)/SUMRP$	PKP4[2:0]="101"	
KVP39	VDH- $V^*(VxRP0+86R+VRHP)/SUMRP$	PKP4[2:0]="110"	
KVP40	VDH- $V^*(VxRP0+87R+VRHP)/SUMRP$	PKP4[2:0]="111"	
KVP41	VDH- $V^*(VxRP0+87R+VRHP+VRLP)/SUMRP$	PKP4[2:0]="000"	VINP6
KVP42	VDH- $V^*(VxRP0+91R+VRHP+VRLP)/SUMRP$	PKP5[2:0]="001"	
KVP43	VDH- $V^*(VxRP0+95R+VRHP+VRLP)/SUMRP$	PKP5[2:0]="010"	
KVP44	VDH- $V^*(VxRP0+99R+VRHP+VRLP)/SUMRP$	PKP5[2:0]="011"	
KVP45	VDH- $V^*(VxRP0+103R+VRHP+VRLP)/SUMRP$	PKP5[2:0]="100"	
KVP46	VDH- $V^*(VxRP0+107R+VRHP+VRLP)/SUMRP$	PKP5[2:0]="101"	
KVP47	VDH- $V^*(VxRP0+111R+VRHP+VRLP)/SUMRP$	PKP5[2:0]="110"	
KVP48	VDH- $V^*(VxRP0+115R+VRHP+VRLP)/SUMRP$	PKP5[2:0]="111"	
KVP49	VDH- $V^*(VxRP0+120R+VRHP+VRLP)/SUMRP$	-	VINP7

Note 1) Sum of ladder resistors with positive polarities = 128R+VRHP+VRLP+VRP0+VRP1

Note 2) Sum of ladder resistors with negative polarities = 128R+VRHN+VRLN+VRN0+VRN1

Note 3) ΔV : Electric potential difference between VDH and VGS

Formulas for calculating voltage (Positive polarity) (2)

Grayscale voltage	Formula
V0	VINP0
V1	VINP1
V2	$V8+(V1-V8)*(30/48)$
V3	$V8+(V1-V8)*(23/48)$
V4	$V8+(V1-V8)*(16/48)$
V5	$V8+(V1-V8)*(12/48)$
V6	$V8+(V1-V8)*(8/48)$
V7	$V8+(V1-V8)*(4/48)$
V8	VINP2
V9	$V20+(V8-V20)*(22/24)$
V10	$V20+(V8-V20)*(20/24)$
V11	$V20+(V8-V20)*(18/24)$
V12	$V20+(V8-V20)*(16/24)$
V13	$V20+(V8-V20)*(14/24)$
V14	$V20+(V8-V20)*(12/24)$
V15	$V20+(V8-V20)*(10/24)$
V16	$V20+(V8-V20)*(8/24)$
V17	$V20+(V8-V20)*(6/24)$
V18	$V20+(V8-V20)*(4/24)$
V19	$V20+(V8-V20)*(2/24)$
V20	VINP3
V21	$V43+(V20-V43)*(22/23)$
V22	$V43+(V20-V43)*(21/23)$
V23	$V43+(V20-V43)*(20/23)$
V24	$V43+(V20-V43)*(19/23)$
V25	$V43+(V20-V43)*(18/23)$
V26	$V43+(V20-V43)*(17/23)$
V27	$V43+(V20-V43)*(16/23)$
V28	$V43+(V20-V43)*(15/23)$
V29	$V43+(V20-V43)*(14/23)$
V30	$V43+(V20-V43)*(13/23)$
V31	$V43+(V20-V43)*(12/23)$

Grayscale voltage	Formula
V32	$V43+(V20-V43)*(11/23)$
V33	$V43+(V20-V43)*(10/23)$
V34	$V43+(V20-V43)*(9/23)$
V35	$V43+(V20-V43)*(8/23)$
V36	$V43+(V20-V43)*(7/23)$
V37	$V43+(V20-V43)*(6/23)$
V38	$V43+(V20-V43)*(5/23)$
V39	$V43+(V20-V43)*(4/23)$
V40	$V43+(V20-V43)*(3/23)$
V41	$V43+(V20-V43)*(2/23)$
V42	$V43+(V20-V43)*(1/23)$
V43	VINP4
V44	$V55+(V43-V55)*(22/24)$
V45	$V55+(V43-V55)*(20/24)$
V46	$V55+(V43-V55)*(18/24)$
V47	$V55+(V43-V55)*(16/24)$
V48	$V55+(V43-V55)*(14/24)$
V49	$V55+(V43-V55)*(12/24)$
V50	$V55+(V43-V55)*(10/24)$
V51	$V55+(V43-V55)*(8/24)$
V52	$V55+(V43-V55)*(6/24)$
V53	$V55+(V43-V55)*(4/24)$
V54	$V55+(V43-V55)*(2/24)$
V55	VINP5
V56	$V62+(V55-V62)*(44/48)$
V57	$V62+(V55-V62)*(40/48)$
V58	$V62+(V55-V62)*(36/48)$
V59	$V62+(V55-V62)*(32/48)$
V60	$V62+(V55-V62)*(28/48)$
V61	$V62+(V55-V62)*(24/48)$
V62	VINP6
V63	VINP7

Note 1) Make sure $DDVDH - V0 > 0.5V$, $DDVDH - V4 > 1.1V$, $V55-GND > 1.1V$

Formulas for calculating voltage (Negative polarity) (1)

Pins	Formula	Fine-adjustment registers	Reference voltage
KVN0	VDH- $V^*(VxRN0)/SUMRN$	-	VINN0
KVN1	VDH- $V^*(VxRN0+5R)/SUMRN$	PKN0[2:0]="000"	VINN1
KVN2	VDH- $V^*(VxRN0+9R)/SUMRN$	PKN0[2:0]="001"	
KVN3	VDH- $V^*(VxRN0+13R)/SUMRN$	PKN0[2:0]="010"	
KVN4	VDH- $V^*(VxRN0+17R)/SUMRN$	PKN0[2:0]="011"	
KVN5	VDH- $V^*(VxRN0+21R)/SUMRN$	PKN0[2:0]="100"	
KVN6	VDH- $V^*(VxRN0+25R)/SUMRN$	PKN0[2:0]="101"	
KVN7	VDH- $V^*(VxRN0+29R)/SUMRN$	PKN0[2:0]="110"	
KVN8	VDH- $V^*(VxRN0+33R)/SUMRN$	PKN0[2:0]="111"	
KVN9	VDH- $V^*(VxRN0+33R+VRHN)/SUMRN$	PKN1[2:0]="000"	VINN2
KVN10	VDH- $V^*(VxRN0+34R+VRHN)/SUMRN$	PKN1[2:0]="001"	
KVN11	VDH- $V^*(VxRN0+35R+VRHN)/SUMRN$	PKN1[2:0]="010"	
KVN12	VDH- $V^*(VxRN0+36R+VRHN)/SUMRN$	PKN1[2:0]="011"	
KVN13	VDH- $V^*(VxRN0+37R+VRHN)/SUMRN$	PKN1[2:0]="100"	
KVN14	VDH- $V^*(VxRN0+38R+VRHN)/SUMRN$	PKN1[2:0]="101"	
KVN15	VDH- $V^*(VxRN0+39R+VRHN)/SUMRN$	PKN1[2:0]="110"	
KVN16	VDH- $V^*(VxRN0+40R+VRHN)/SUMRN$	PKN1[2:0]="111"	
KVN17	VDH- $V^*(VxRN0+45R+VRHN)/SUMRN$	PKN2[2:0]="000"	VINN3
KVN18	VDH- $V^*(VxRN0+46R+VRHN)/SUMRN$	PKN2[2:0]="001"	
KVN19	VDH- $V^*(VxRN0+47R+VRHN)/SUMRN$	PKN2[2:0]="010"	
KVN20	VDH- $V^*(VxRN0+48R+VRHN)/SUMRN$	PKN2[2:0]="011"	
KVN21	VDH- $V^*(VxRN0+49R+VRHN)/SUMRN$	PKN2[2:0]="100"	
KVN22	VDH- $V^*(VxRN0+50R+VRHN)/SUMRN$	PKN2[2:0]="101"	
KVN23	VDH- $V^*(VxRN0+51R+VRHN)/SUMRN$	PKN2[2:0]="110"	
KVN24	VDH- $V^*(VxRN0+52R+VRHN)/SUMRN$	PKN2[2:0]="111"	
KVN25	VDH- $V^*(VxRN0+68R+VRHN)/SUMRN$	PKN3[2:0]="000"	VINN4
KVN26	VDH- $V^*(VxRN0+69R+VRHN)/SUMRN$	PKN3[2:0]="001"	
KVN27	VDH- $V^*(VxRN0+70R+VRHN)/SUMRN$	PKN3[2:0]="010"	
KVN28	VDH- $V^*(VxRN0+71R+VRHN)/SUMRN$	PKN3[2:0]="011"	
KVN29	VDH- $V^*(VxRN0+72R+VRHN)/SUMRN$	PKN3[2:0]="100"	
KVN30	VDH- $V^*(VxRN0+73R+VRHN)/SUMRN$	PKN3[2:0]="101"	
KVN31	VDH- $V^*(VxRN0+74R+VRHN)/SUMRN$	PKN3[2:0]="110"	
KVN32	VDH- $V^*(VxRN0+75R+VRHN)/SUMRN$	PKN3[2:0]="111"	
KVN33	VDH- $V^*(VxRN0+80R+VRHN)/SUMRN$	PKN4[2:0]="000"	VINN5
KVN34	VDH- $V^*(VxRN0+81R+VRHN)/SUMRN$	PKN4[2:0]="001"	
KVN35	VDH- $V^*(VxRN0+82R+VRHN)/SUMRN$	PKN4[2:0]="010"	
KVN36	VDH- $V^*(VxRN0+83R+VRHN)/SUMRN$	PKN4[2:0]="011"	
KVN37	VDH- $V^*(VxRN0+84R+VRHN)/SUMRN$	PKN4[2:0]="100"	
KVN38	VDH- $V^*(VxRN0+85R+VRHN)/SUMRN$	PKN4[2:0]="101"	
KVN39	VDH- $V^*(VxRN0+86R+VRHN)/SUMRN$	PKN4[2:0]="110"	
KVN40	VDH- $V^*(VxRN0+87R+VRHN)/SUMRN$	PKN4[2:0]="111"	
KVN41	VDH- $V^*(VxRN0+87R+VRHN+VRLN)/SUMRN$	PKN4[2:0]="000"	VINN6
KVN42	VDH- $V^*(VxRN0+91R+VRHN+VRLN)/SUMRN$	PKN5[2:0]="001"	
KVN43	VDH- $V^*(VxRN0+95R+VRHN+VRLN)/SUMRN$	PKN5[2:0]="010"	
KVN44	VDH- $V^*(VxRN0+99R+VRHN+VRLN)/SUMRN$	PKN5[2:0]="011"	
KVN45	VDH- $V^*(VxRN0+103R+VRHN+VRLN)/SUMRN$	PKN5[2:0]="100"	
KVN46	VDH- $V^*(VxRN0+107R+VRHN+VRLN)/SUMRN$	PKN5[2:0]="101"	
KVN47	VDH- $V^*(VxRN0+111R+VRHN+VRLN)/SUMRN$	PKN5[2:0]="110"	
KVN48	VDH- $V^*(VxRN0+115R+VRHN+VRLN)/SUMRN$	PKN5[2:0]="111"	
KVN49	VDH- $V^*(VxRN0+120R+VRHN+VRLN)/SUMRN$	-	VINN7

Note 1) Sum of ladder resistors with positive polarities = 128R+VRHP+VRLP+VRP0+VRP1

Note 2) Sum of ladder resistors with negative polarities = 128R+VRHN+VRLN+VRN0+VRN1

Note 3) ΔV :Electric potential difference between VDH and VGS

Formulas for calculating voltage (Negative polarity) (2)

Grayscale voltage	Formula
V0	VINN0
V1	VINN1
V2	$V8+(V1-V8)*(30/48)$
V3	$V8+(V1-V8)*(23/48)$
V4	$V8+(V1-V8)*(16/48)$
V5	$V8+(V1-V8)*(12/48)$
V6	$V8+(V1-V8)*(8/48)$
V7	$V8+(V1-V8)*(4/48)$
V8	VINN2
V9	$V20+(V8-V20)*(22/24)$
V10	$V20+(V8-V20)*(20/24)$
V11	$V20+(V8-V20)*(18/24)$
V12	$V20+(V8-V20)*(16/24)$
V13	$V20+(V8-V20)*(14/24)$
V14	$V20+(V8-V20)*(12/24)$
V15	$V20+(V8-V20)*(10/24)$
V16	$V20+(V8-V20)*(8/24)$
V17	$V20+(V8-V20)*(6/24)$
V18	$V20+(V8-V20)*(4/24)$
V19	$V20+(V8-V20)*(2/24)$
V20	VINN3
V21	$V43+(V20-V43)*(22/23)$
V22	$V43+(V20-V43)*(21/23)$
V23	$V43+(V20-V43)*(20/23)$
V24	$V43+(V20-V43)*(19/23)$
V25	$V43+(V20-V43)*(18/23)$
V26	$V43+(V20-V43)*(17/23)$
V27	$V43+(V20-V43)*(16/23)$
V28	$V43+(V20-V43)*(15/23)$
V29	$V43+(V20-V43)*(14/23)$
V30	$V43+(V20-V43)*(13/23)$
V31	$V43+(V20-V43)*(12/23)$

Grayscale voltage	Formula
V32	$V43+(V20-V43)*(11/23)$
V33	$V43+(V20-V43)*(10/23)$
V34	$V43+(V20-V43)*(9/23)$
V35	$V43+(V20-V43)*(8/23)$
V36	$V43+(V20-V43)*(7/23)$
V37	$V43+(V20-V43)*(6/23)$
V38	$V43+(V20-V43)*(5/23)$
V39	$V43+(V20-V43)*(4/23)$
V40	$V43+(V20-V43)*(3/23)$
V41	$V43+(V20-V43)*(2/23)$
V42	$V43+(V20-V43)*(1/23)$
V43	VINN4
V44	$V55+(V43-V55)*(22/24)$
V45	$V55+(V43-V55)*(20/24)$
V46	$V55+(V43-V55)*(18/24)$
V47	$V55+(V43-V55)*(16/24)$
V48	$V55+(V43-V55)*(14/24)$
V49	$V55+(V43-V55)*(12/24)$
V50	$V55+(V43-V55)*(10/24)$
V51	$V55+(V43-V55)*(8/24)$
V52	$V55+(V43-V55)*(6/24)$
V53	$V55+(V43-V55)*(4/24)$
V54	$V55+(V43-V55)*(2/24)$
V55	VINN5
V56	$V62+(V55-V62)*(44/48)$
V57	$V62+(V55-V62)*(40/48)$
V58	$V62+(V55-V62)*(36/48)$
V59	$V62+(V55-V62)*(32/48)$
V60	$V62+(V55-V62)*(28/48)$
V61	$V62+(V55-V62)*(24/48)$
V62	VINN6
V63	VINN7

Note 1) Make sure $DDVDH - V0 > 0.5V$, $DDVDH - V4 > 1.1V$, $V55-GND > 1.1V$

Relationship between RAM data and output level (REV =0)

The relationship between the RAM data and the source output level is as follows.

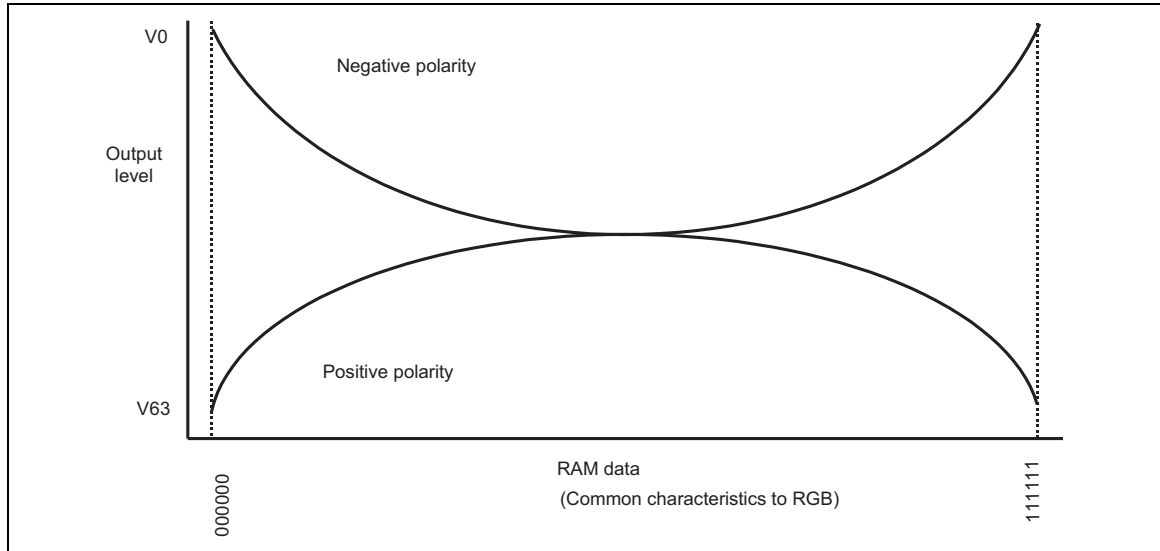

RAM data and the output voltage (REV = 0)

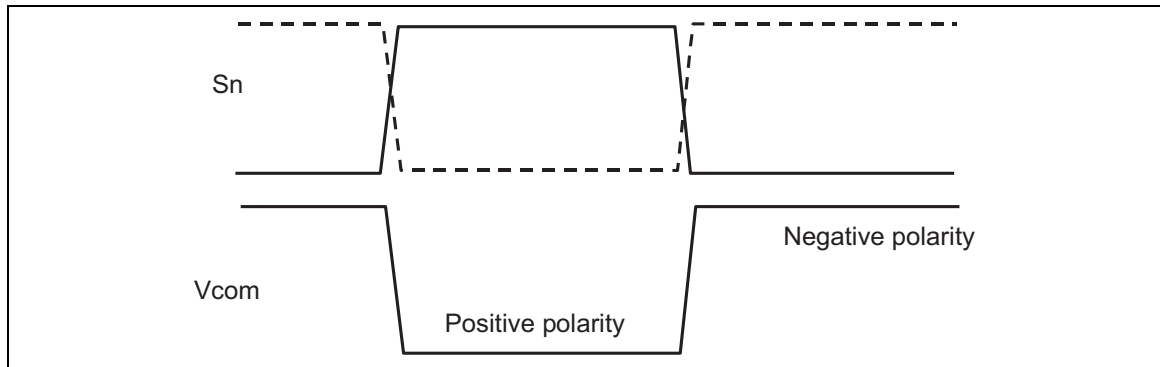

Source output and Vcom

Relationship between RAM data and output level (REV =1)

The relationship between the RAM data and the source output level is as follows.

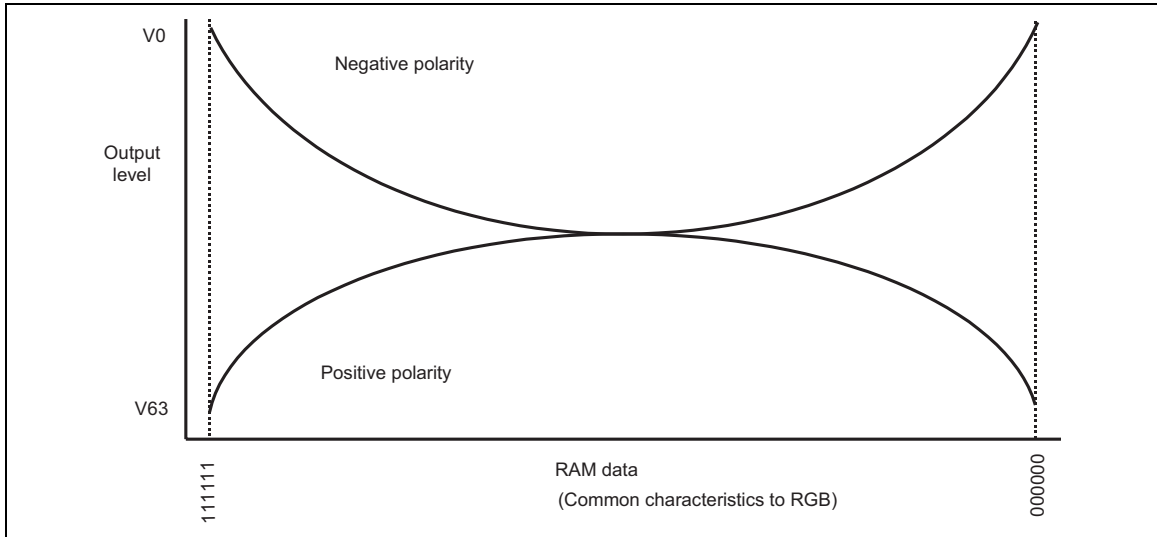

RAM data and the output voltage (REV = 1)

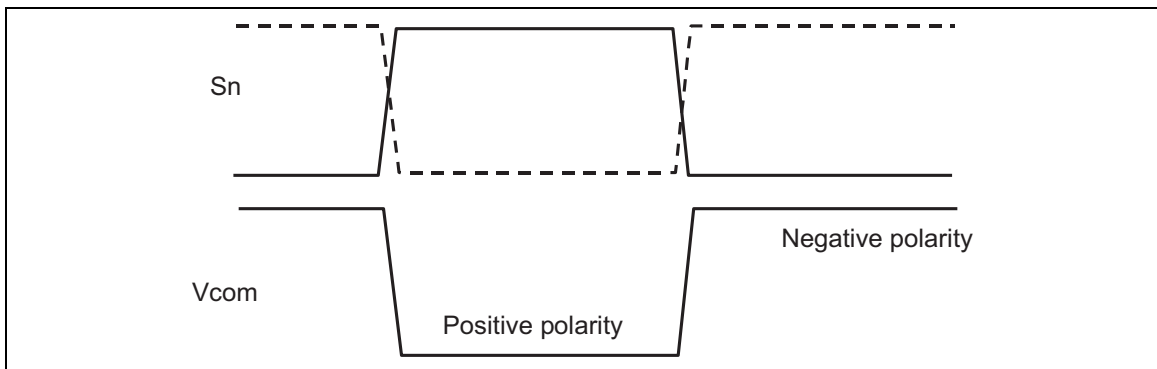

Source output and Vcom

Low Power Consumption Display Mode

Setting COL[1:0] to 2'h1 halts 32 amplifiers among V0 ~ V63 grayscale amplifiers to display with low power consumption. In combination with the FRC mode setting, it is possible to realize display with low power consumption in abundant colors.

To make a setting for the low power consumption display, set in accordance to the following table according to the interface in use. The setting must be made in accordance to the setting sequence for low power consumption display mode.

Using this mode with short screen refreshing cycle may affect the quality of display. Consider the trade-off between the display quality and power-saving effects before use.

Table 71

Interface mode	FRCON	D16B	Available colors
18 bit, 16 bit x2, 9 bit x2, 8 bit x3, RGB18bit, 6 bit x3	0	*	262,144
	1	0	250,047
16bit x1, 8 bit x2, SPI	0	*	65,536
	1	1	64,512

Note 1) When the FRC mode is on, do not switch the interface mode settings (M, TRI, D16B registers)

Note 2) When the FRC mode is on, 18-bit format data and 16-bit format data are not displayed simultaneously.

Table 72

COL[1:0]	Amplifiers in operation	Available colors for display	
		FRCON = 0	FRCON = 1
2'h0	64	262,144 colors/65,536 colors	-
2'h1	32	32,768 colors	250,047 colors/64,512 colors
2'h2	2	8 colors	-
2'h3	Setting disabled	Setting disabled	Setting disabled

Note 1) When COL[1:0] = 2'h1 and FRCON = 0, do not write data that correspond to the grayscale levels for which the amplifiers are halted.

Table 73 grayscale level amplifiers in operation

amplifier	COL[1:0]			GRAM data RGB	
	2'h0	2'h1	2'h2		
V0	*	*	*	6'h00	6'h3F
V1	*			6'h01	6'h3E
V2	*	*		6'h02	6'h3D
V3	*			6'h03	6'h3C
V4	*	*		6'h04	6'h3B
V5	*			6'h05	6'h3A
V6	*	*		6'h06	6'h39
V7	*			6'h07	6'h38
V8	*	*		6'h08	6'h37
V9	*			6'h09	6'h36
V10	*	*		6'h0A	6'h35
V11	*			6'h0B	6'h34
V12	*	*		6'h0C	6'h33
V13	*			6'h0D	6'h32
V14	*	*		6'h0E	6'h31
V15	*			6'h0F	6'h30
V16	*	*		6'h10	6'h2F
V17	*			6'h11	6'h2E
V18	*	*		6'h12	6'h2D
V19	*			6'h13	6'h2C
V20	*	*		6'h14	6'h2B
V21	*			6'h15	6'h2A
V22	*	*		6'h16	6'h29
V23	*			6'h17	6'h28
V24	*	*		6'h18	6'h27
V25	*			6'h19	6'h26
V26	*	*		6'h1A	6'h25
V27	*			6'h1B	6'h24
V28	*	*		6'h1C	6'h23
V29	*			6'h1D	6'h22
V30	*	*		6'h1E	6'h21
V31	*			6'h1F	6'h20

*: amplifier in operation

amplifier	COL[1:0]			GRAM data RGB	
	2'h0	2'h1	2'h2		
V32	*			6'h20	6'h1F
V33	*	*		6'h21	6'h1E
V34	*			6'h22	6'h1D
V35	*	*		6'h23	6'h1C
V36	*			6'h24	6'h1B
V37	*	*		6'h25	6'h1A
V38	*			6'h26	6'h19
V39	*	*		6'h27	6'h18
V40	*			6'h28	6'h17
V41	*	*		6'h29	6'h16
V42	*			6'h2A	6'h15
V43	*	*		6'h2B	6'h14
V44	*			6'h2C	6'h13
V45	*	*		6'h2D	6'h12
V46	*			6'h2E	6'h11
V47	*	*		6'h2F	6'h10
V48	*			6'h30	6'h0F
V49	*	*		6'h31	6'h0E
V50	*			6'h32	6'h0D
V51	*	*		6'h33	6'h0C
V52	*			6'h34	6'h0B
V53	*	*		6'h35	6'h0A
V54	*			6'h36	6'h09
V55	*	*		6'h37	6'h08
V56	*			6'h38	6'h07
V57	*	*		6'h39	6'h06
V58	*			6'h3A	6'h05
V59	*	*		6'h3B	6'h04
V60	*			6'h3C	6'h03
V61	*	*		6'h3D	6'h02
V62	*			6'h3E	6'h01
V63	*	*	*	6'h3F	6'h00

The following table shows the relationship between GRAM data and liquid crystal grayscale level.

Table 74 GRAM data and LCD grayscale level (REV = 0) in FRC mode

GRAM data RGB	Selected grayscale level		GRAM data RGB	Selected grayscale level	
	positive	negative		positive	negative
6'h00	V0	V63	6'h20	$(V30+V33)/2$	$(V30+V33)/2$
6'h01	$(V0+V2)/2$	$(V61+V63)/2$	6'h21	V33	V30
6'h02	V2	V61	6'h22	$(V33+V35)/2$	$(V28+V30)/2$
6'h03	$(V2+V4)/2$	$(V59+V61)/2$	6'h23	V35	V28
6'h04	V4	V59	6'h24	$(V35+V37)/2$	$(V26+V28)/2$
6'h05	$(V4+V6)/2$	$(V57+V59)/2$	6'h25	V37	V26
6'h06	V6	V57	6'h26	$(V37+V39)/2$	$(V24+V26)/2$
6'h07	$(V6+V8)/2$	$(V55+V57)/2$	6'h27	V39	V24
6'h08	V8	V55	6'h28	$(V39+V41)/2$	$(V22+V24)/2$
6'h09	$(V8+V10)/2$	$(V53+V55)/2$	6'h29	V41	V22
6'h0A	V10	V53	6'h2A	$(V41+V43)/2$	$(V20+V22)/2$
6'h0B	$(V10+V12)/2$	$(V51+V53)/2$	6'h2B	V43	V20
6'h0C	V12	V51	6'h2C	$(V43+V45)/2$	$(V18+V20)/2$
6'h0D	$(V12+V14)/2$	$(V49+V51)/2$	6'h2D	V45	V18
6'h0E	V14	V49	6'h2E	$(V45+V47)/2$	$(V16+V18)/2$
6'h0F	$(V14+V16)/2$	$(V47+V49)/2$	6'h2F	V47	V16
6'h10	V16	V47	6'h30	$(V47+V49)/2$	$(V14+V16)/2$
6'h11	$(V16+V18)/2$	$(V45+V47)/2$	6'h31	V49	V14
6'h12	V18	V45	6'h32	$(V49+V51)/2$	$(V12+V14)/2$
6'h13	$(V18+V20)/2$	$(V43+V45)/2$	6'h33	V51	V12
6'h14	V20	V43	6'h34	$(V51+V53)/2$	$(V10+V12)/2$
6'h15	$(V20+V22)/2$	$(V41+V43)/2$	6'h35	V53	V10
6'h16	V22	V41	6'h36	$(V53+V55)/2$	$(V8+V10)/2$
6'h17	$(V22+V24)/2$	$(V39+V41)/2$	6'h37	V55	V8
6'h18	V24	V39	6'h38	$(V55+V57)/2$	$(V6+V8)/2$
6'h19	$(V24+V26)/2$	$(V37+V39)/2$	6'h39	V57	V6
6'h1A	V26	V37	6'h3A	$(V57+V59)/2$	$(V4+V6)/2$
6'h1B	$(V26+V28)/2$	$(V35+V37)/2$	6'h3B	V59	V4
6'h1C	V28	V35	6'h3C	$(V59+V61)/2$	$(V2+V4)/2$
6'h1D	$(V28+V30)/2$	$(V33+V35)/2$	6'h3D	V61	V2
6'h1E	V30	V33	6'h3E	$(V61+V63)/2$	$(V0+V2)/2$
6'h1F	$(V30+V33)/2$	$(V30+V33)/2$	6'h3F	V63	V0

Note 1) This table shows effective grayscale levels by FRC grayscale.

8-color Display Mode

The HD66781 incorporates an 8-color display mode. The available grayscale levels are V0 and V63, and the voltages for the other levels (V1-V62) are halted to reduce power consumption.

The γ -fine-adjustment registers, PKP0-PKP5 and PKN0-PKN5 are not available in the 8-color display mode. Since the power supplies for the levels V1-V62 are halted in the 8-color mode, data are converted to automatically select V0/V63 levels: the MSB of each R, G, B, pixel of GRAM data is allocated to the lower 5 bits of R, G, B of display data. The HD 66781 enables to switch between 8-color and normal display modes without rewriting GRAM data only with the COL setting.

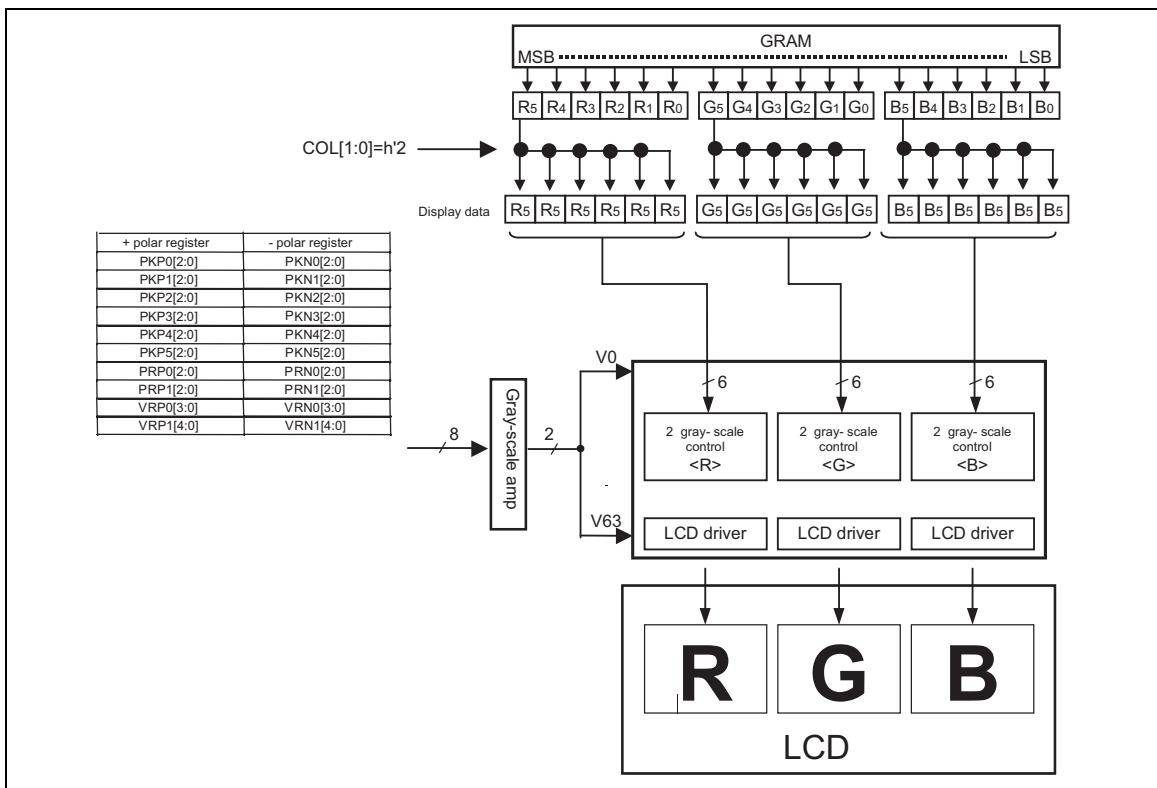

Oscillation Circuit

The HD66781 generates oscillation by an internal R-C oscillator with an external oscillation resistor placed between the OSC1 and OSC2 pins. The oscillation frequency varies depending on the value of external resistor, the distance of wiring, and the operational power supply voltage. For example, the oscillation frequency becomes low when increasing the value of Rf resistor, or lowering the power supply voltage. See the “Notes to Electric Characteristics” section for the relationship between the Rf resistor value and the oscillation frequency.

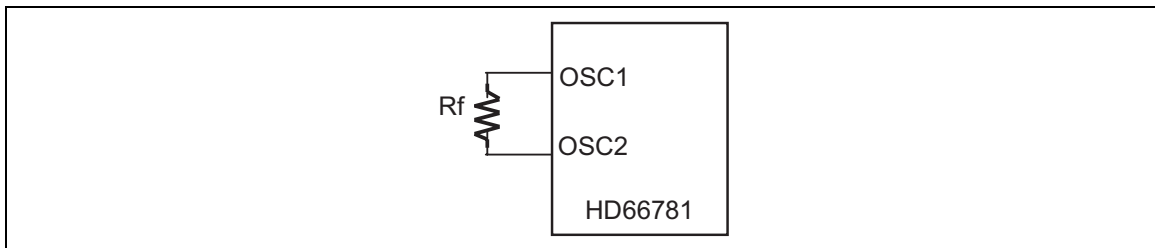

External Resistor Oscillation Mode

Note 1) Place the Rf resistor as close to the OSC1, OSC2 pins as possible.

Note 2) Make sure not to arrange other wiring close to or beneath OSC1-OSC2 wiring to avoid effects from coupling

n-raster-row Inversion alternating Drive

The HD66781, in addition to LCD inversion alternating drive by frame, supports n-raster-row inversion alternating drive where alternation occurs by n raster-rows, where n takes a number from 1 to 64. The n-raster-row inversion alternating drive enables to overcome the problems related to display quality.

In determining n (the value set by the NW bit +1), the number of raster-rows by which alternation occurs, check the display quality on the actual liquid crystal panel. Setting a small number of raster-rows will raise the alternating frequency of the liquid crystal and increase the charge/discharge current on the liquid crystal cells.

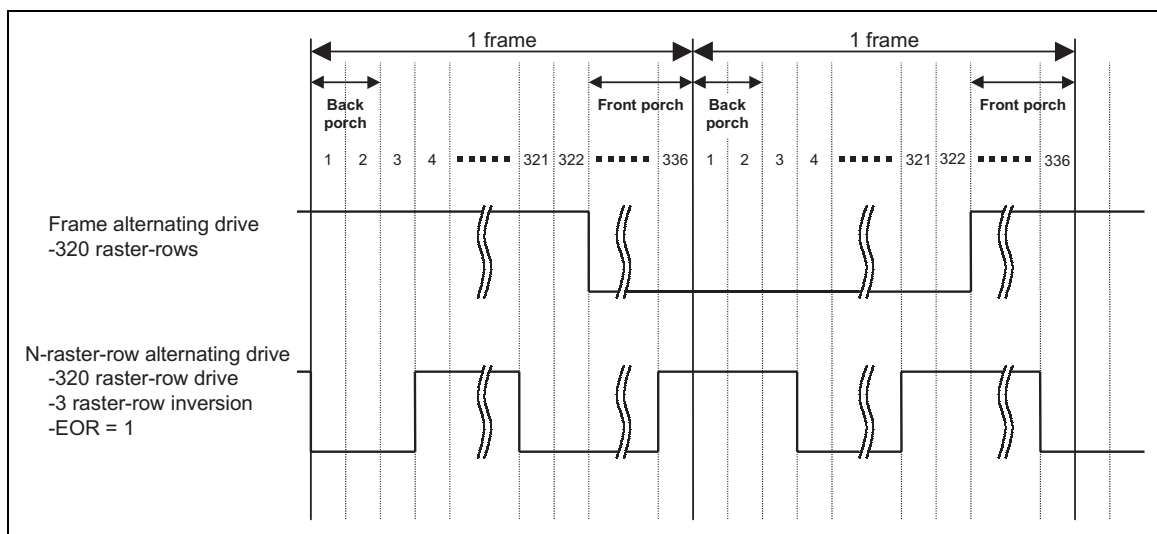

n-raster-row alternating drive

Note 1) Make sure to set EOR = 1 to avoid direct bias on liquid crystal during n-raster-row alternating drive.

Interlaced Drive

The HD66781 supports interlaced drive, which divides one frame into n fields and then drives to prevent flickers.

To determine the number of fields (n: value set by the FLD bits), check the display quality on the actual liquid crystal panel. The following table shows the gate selection for each number of fields, 1 to 3. The figure illustrates the output waveforms of the 3-field interlaced drive.

Table 75

GA=0, SM=0, GS0=0, GS1=0					GA=1, SM=0, GS0=0, GS1=1				
FLD1-0	2'h1		2'h3		FLD1-0	2'h1		2'h3	
Field	-	1	2	3	Field	-	1	2	3
Gate					Gate				
G1	O	O			G328	O	O		
G2	O		O		G327	O		O	
G3	O			O	G326	O			O
G4	O	O			G325	O	O		
G5	O		O		G324	O		O	
G6	O			O	G323	O			O
G7	O	O			G322	O	O		
G8	O		O		G321	O		O	
G9	O			O	G320	O			O
•	•	•	•	•	•	•	•	•	•
•	•	•	•	•	•	•	•	•	•
•	•	•	•	•	•	•	•	•	•
G317	O		O		G12	O		O	
G318	O			O	G11	O			O
G319	O	O			G10	O	O		
G320	O		O		G9	O		O	

Note 1) Interlaced drive is not available in RGB interface mode.

Note 2) Middle porch must be set to BP = 3 (3 lines) for interlaced drive.

Note 3) OSD (α blending), scrolling, and resizing functions are not available with interlaced drive.

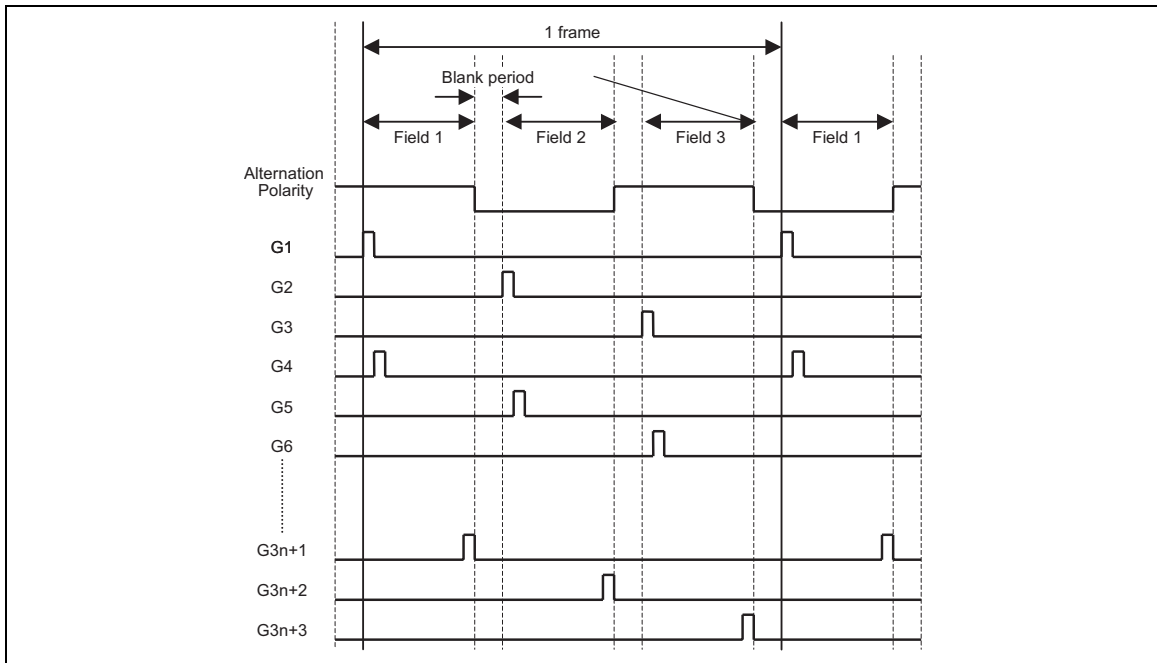

3-field interlaced drive: gate output timing

Alternating Timing

The following figure illustrates the alternating timing of each alternating drive formula. In case of frame inversion alternating drive, alternation occurs at the completion of one frame, followed by a blank that lasts for 16H periods. In case of interlaced drive, alternation occurs at the completion of one field, followed by a blank. The total period of the blanks in one frame adds up to 16H period. In case of n-raster-row, a blank lasting 16H period is inserted after all screens are drawn.

During interlaced drive, make the numbers of back, front porches more than the numbers of fields.

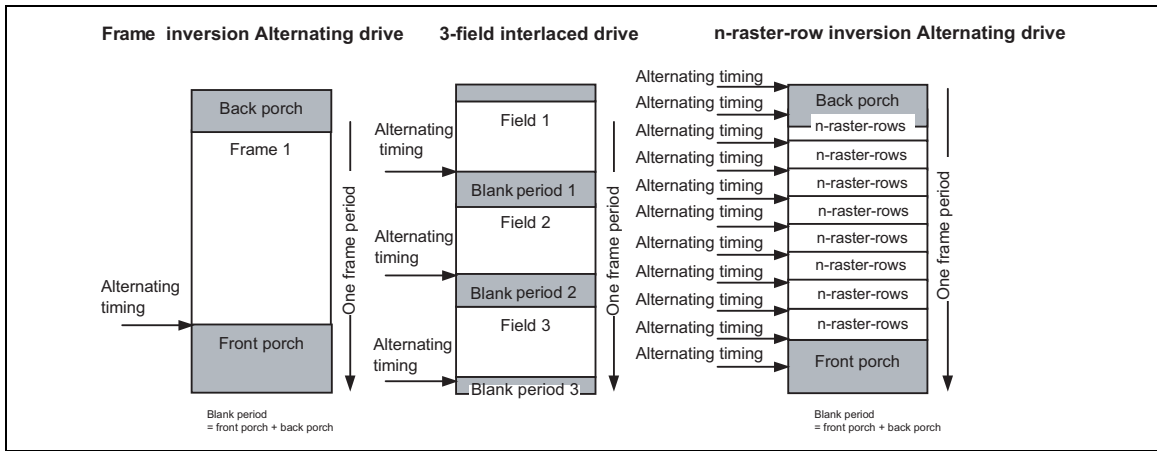

Alternating timing

Frame-Frequency Adjustment Function

The HD66781 incorporates frame frequency adjustment function. The frame frequency during the liquid crystal drive is adjusted by the instruction setting (DIVI, RTNI) while keeping the oscillation frequency fixed.

By setting the oscillation frequency high in advance, it becomes possible to switch the frame frequency in accordance to the kind of displayed picture (i.e. moving/still picture). When displaying a still picture, set the frame frequency low to save power consumption, while setting the frame frequency high when displaying a moving picture which requires high-speed screen switching.

Relationship between Liquid Crystal Drive Duty and Frame Frequency

The relationship between the liquid crystal drive duty and the frame frequency is calculated by the following formula. The frame frequency is adjusted by the instruction setting with the 1-H period adjustment bit (RTNI bit) and the operation clock division bit (DIVI bit).

(Formula for the frame frequency)

$$\text{Frame frequency} = \frac{f_{osc}}{\text{Clock cycles per raster-row} \times \text{division ratio} \times (\text{Line} + \text{BP} + \text{FP})} \quad [\text{Hz}]$$

f_{osc}	: R-C oscillation frequency
Clock cycles per raster-row	: RTNI bits
Division ratio	: DIVI bit
Line	: number of drive raster-rows (NL)
Front Porch	: FP bits
Back Porch	: BP bits

Calculation Example The maximum frame frequency = 60 Hz

Number of drive raster-row	: 320
1-H period	: 16 clock cycles (RTNI[4:0] = 2'h10)
Operation clock division ratio	: 1 division

$$f_{osc} = 60 \text{ Hz} \times 16 \text{ clocks} \times 1 \text{ division} \times (320+2+14) \text{ lines} = 323 \text{ (kHz)}$$

In this case, the R-C oscillation frequency becomes 323 kHz. Adjust the value of external resistor for R-C oscillator to set the frequency 323kHz.

Partial Display Function

The HD66781 enables arbitrary settings for on-display picture RAM area and the display position on the screen with the use of OSD. When the display of base image is turned off (BASEE=0), OSD is displayed 100%.

By making settings for OSD RAM area (OSA, OEA) and OSD position (ODP), the HD66781 allows displaying an arbitrary set of data. Other than OSD area becomes no-display area to reduce power consumption.

The partial display area using OSD can be made up to 3 areas.

In combination with 8-color mode and off-scan settings (PTS, PTG, ISC), more power-saving display will be obtained. Make an appropriate setting taking power-saving effect and display quality into consideration.

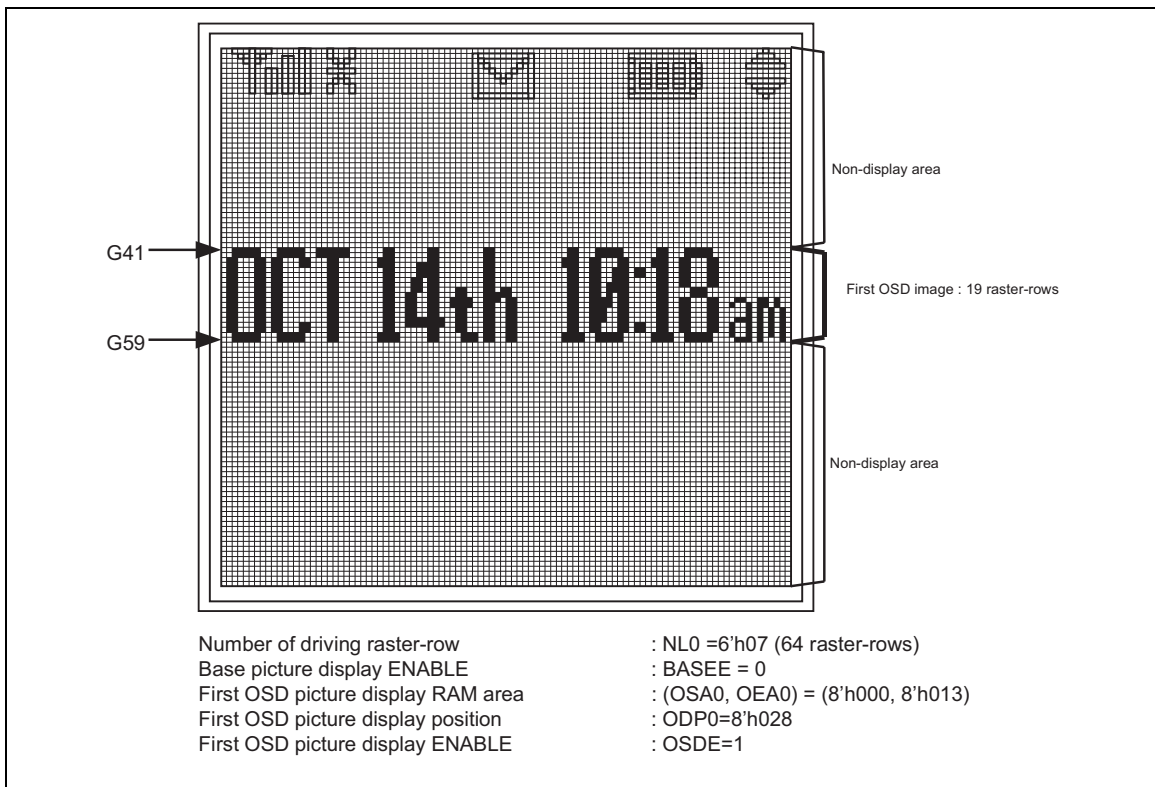

Partial Display

Note 1) See the "RAM Address and Display Position on the Panel" for more details on the relationship between the display area and the setting of RAM area.

Power-saving drive settings

The HD66781 incorporates various settings for lower power consumption display. The low power consumption and the quality of display are in trade-off, and the power-saving effect may vary depending on the characteristics of a panel. Make an appropriate setting among the settings listed below taking the trade-off into consideration.

1. 8-color display mode (COL)

When this mode is selected (COL [1:0] = 2'h2), voltage generation for grayscale levels other than V0 and V63 levels is halted. In this mode, only 8 colors are available for display for saving power.

2. Low power consumption display mode (COL, FRC)

Setting COL[1:0] to 2'h1 halts 32 amplifiers among V0 ~ V63 grayscale amplifiers to display with low power consumption. In combination with the FRC mode setting, it is possible to realize display with low power consumption in abundant colors.

In this mode, 250,047 colors are available with 18-bit, 16-bit x2, 9-bit x2, 8-bit x3 (RGB 6 bits each) interfaces and 64,512 colors are available with 16-bit x1, 8-bit x2 interfaces and SPI (R, B: 5 bits, G: 6 bits). Using this mode with short screen refreshing cycle may affect the quality of display. Consider the trade-off between the display quality and power-saving effects before use. See the "Low power consumption display mode" (p.169) for details.

3. Partial display (OSD)

The partial display is made with OSD and base image display off setting (BASEE = 0). Display operation is limited to the partial display area to save power. Power saving effects will increase as the number of partial display lines decreases. Also, see "Partial Display Function"(p.139) for details.

4. Non-lit drive setting

The non-lit drive setting is available for partial display and allows specifying the kind of source outputs in the non-lit drive area with PTS bits. Also, in the non-lit drive area, grayscale generation amplifier is halted and step-up clock cycle is slowed down to half.

PTG bits can specify the scan mode of gate bus lines in the non-lit drive area. In the interval gate scan mode, gate bus lines are scanned by the frame cycle specified by ISC bits to hold power consumption required for scanning gate bus lines to minimum. The longer scan cycle may affect the quality of display. Make an appropriate setting by taking trade-off between power-saving effects and display quality.

Table 76 Source outputs in non-display area

PTS[2:0]	Source output in non-display area		Non-display area Grayscale amp operation	Non-display area Step-up clock frequency
	Positive polarity	Negative polarity		
3'h0	V63	V0	V0 to V63	DC0,DC1Setting
3'h1	Setting disabled	Setting disabled	-	-
3'h2	GND	GND	V0 to V63	DC0,DC1Setting
3'h3	Hi-Z	Hi-Z	V0 to V63	DC0,DC1Setting
3'h4	V63	V0	V0,V63	DC0,DC1Setting x1/2
3'h5	Setting disabled	Setting disabled	-	-
3'h6	GND	GND	V0,V63	DC0,DC1Setting x1/2
3'h7	Hi-Z	Hi-Z	V0,V63	DC0,DC1Setting x1/2

Note 1) Gate outputs in non-lit drive area can be controlled by off-scan mode (with PTG bits).

Note 2) The operation halt of grayscale amplifier and the slowdown of step-up clock frequency are valid only to the non-display area.

Note 3) When DC[4:3]=2'h3, the frequency of step-up clocks in the non-display area are not slowed down half even if PTS[2:0] is set to 4, 6 or 7.

Table 77 Gate outputs in non-display area

PTG[1:0]	DISPTMG output	Gate output in non-display area	Source output in non-display area
2'h0	Normal drive	Normal scan	PTS setting
2'h1	GND	DISPTMG (Fixed)	PTS setting
2'h2	Internal drive	Interval scan	PTS setting
2'h3	Setting disabled	-	-

Note 1) When the interval scan is executed, make setting for the frame alternating drive.

Table 78 Interval gate scan frequency

ISC[3:0]	Scan frequency	When (fFLM) = 60Hz
4'h0	Setting disabled	-
4'h1	3 frames	50ms
4'h2	5 frames	84ms
4'h3	7 frames	117ms
4'h4	9 frames	150ms
4'h5	11 frames	184ms
4'h6	13 frames	217ms
4'h7	15 frames	251ms
4'h8	17 frames	284ms
4'h9	19 frames	317ms
4'hA	21 frames	351ms
4'hB	23 frames	384ms
4'hC	25 frames	418ms
4'hD	27 frames	451ms
4'hE	29 frames	484ms
4'hF	31 frames	518ms

5. Frame frequency setting

Frame frequency adjusting functions (with DIVI, RTNI bits) allows changing liquid crystal alternating frequency through instructions. Frame frequency can be reduced to achieve low power consumption while display method with low power consumption such as partial display mode is employed. See “Frame Frequency Adjustment Function”(p.178) section for details.

Generally, the lower frame frequency and the quality of display are in trade-off. The power-saving effects and the quality of display also vary depending on the characteristics of a panel. Check the quality of display on the panel before use.

6. Liquid crystal alternating drive

The HD66781 allows selecting among frame alternating drive, 3-field interlace drive, and line inversion alternating drive through instructions (B/C, EOR, NW, and FLD). Select an appropriate alternating drive method for the kind of display. See the “Alternating Timing”(p.177) section for details.

Generally, the lower frame frequency and the quality of display are in trade-off. The power-saving effects and the quality of display also vary depending on the characteristics of a panel. Check the quality of display on the panel before use.

Equalization function

The HD66781 incorporates source-Vcom equalization function, which short-circuits source outputs S1-S720 and Vcom at alternating points to equalize the electric potential of source capacities and Vcom capacities during “High” period of EQ signal.

By driving source and Vcom from the equalized electric potential, the electric charges accumulated in the source and Vcom capacities are reallocated, and power consumption is reduced.

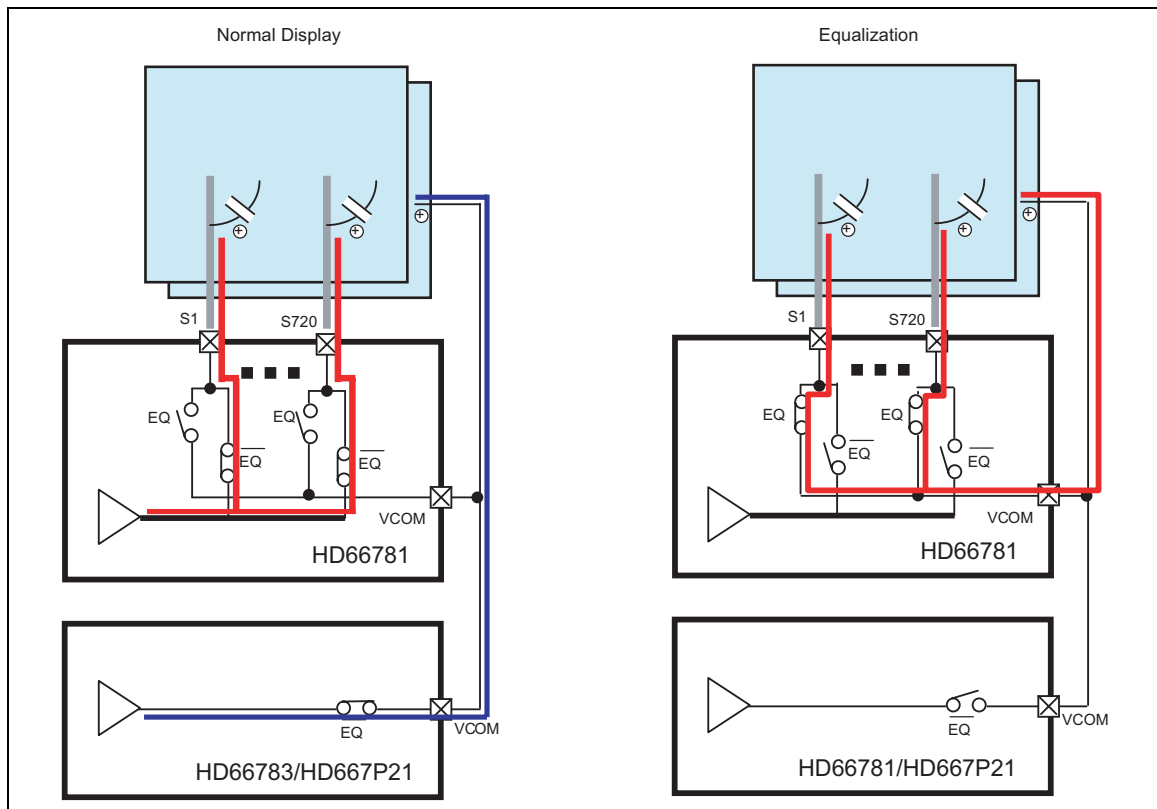

Note 1) Equalization function is only available when Vcom Low level $\geq 0V$

Note 2) Power-saving effects depend on display data.

Specifications of external element of HD66781

The specifications of external element connected to power supply circuit of HD66781 are as follows.

Table 79 Capacitor

Capacitor capacitance	Recommended capacitor voltage	Connection pin
1 μ F Characteristics B	3V	VDD

Instruction Setting

The following flowcharts show the sequences with respect to power on/off of the combined use of HD66781 and HD66783 or HD667P21, display on/off, standby set/release, and sleep set/release. Whenever turning on or off the power supply and so on, it must be done in accordance to the following procedures.

A serial interface is used to make instruction settings to the HD66783 and HD667P21, where a serial transfer is always required. The serial transfer must be made in accordance to the serial transfer sequence and right after the instructions are set.

Timing of the instruction setting is necessary to take into consideration the delay of 16-cycle internal clocks (OSC) from the start of serial transfer from the HD66781 through TE and IDX2-0 before each of the following mode settings becomes effective on the HD66783 and HD667P21.

Power-supply/display ON (LPTS = 0: a-Si TFT panel, with HD66783)

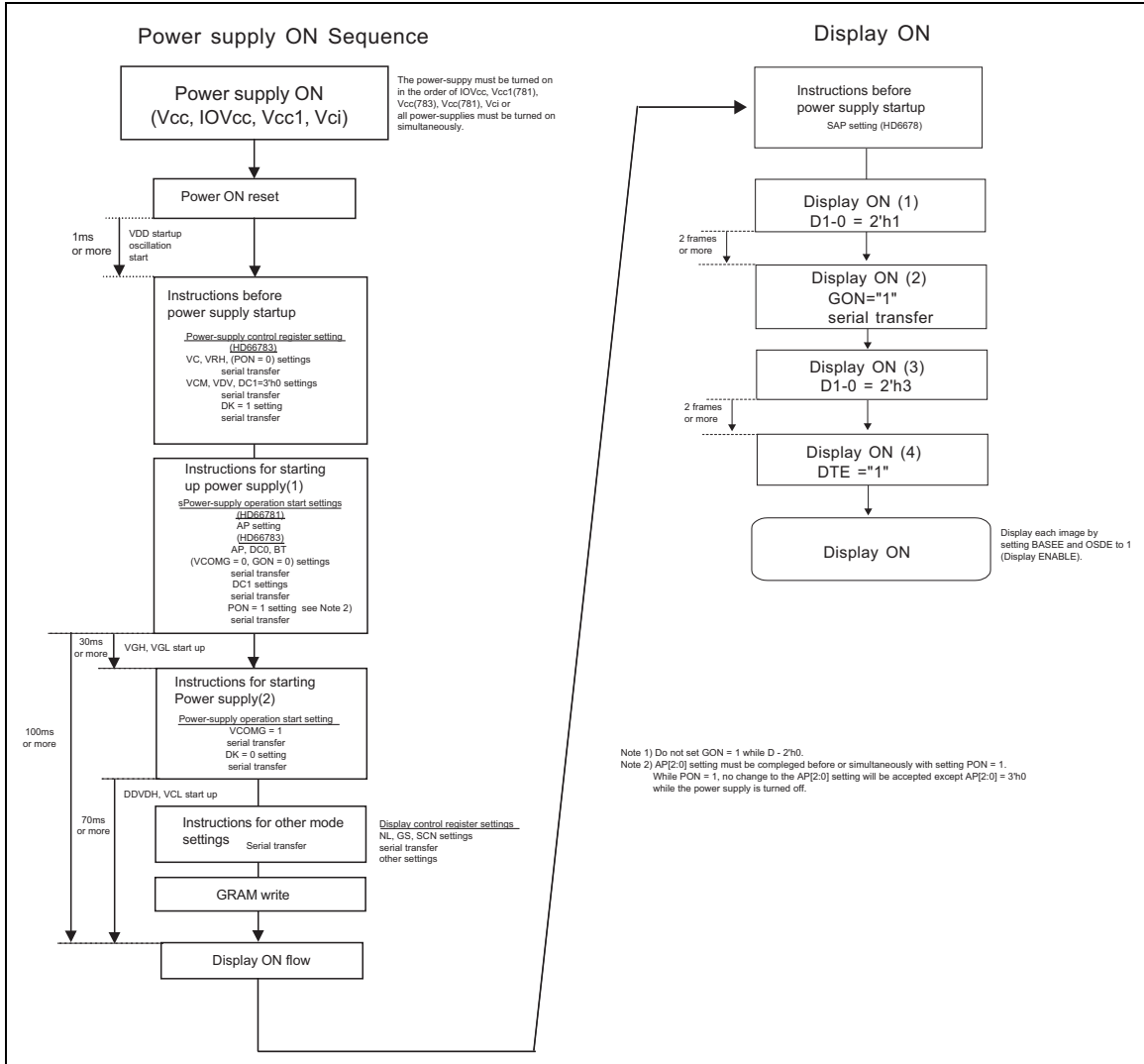

Power-supply/display OFF (LPTS = 0: a-Si TFT panel, with HD66783)

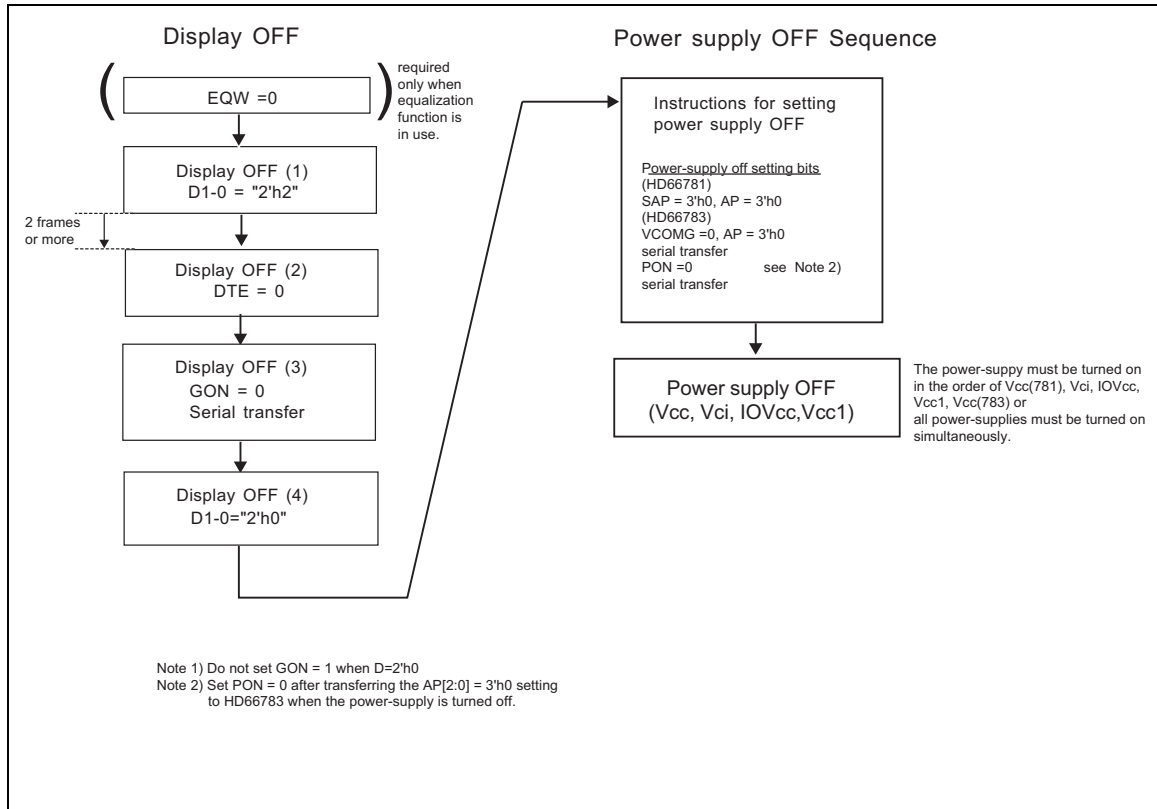

Power-supply/display ON (LPTS = 1: LTPS TFT panel, with HD667P21)

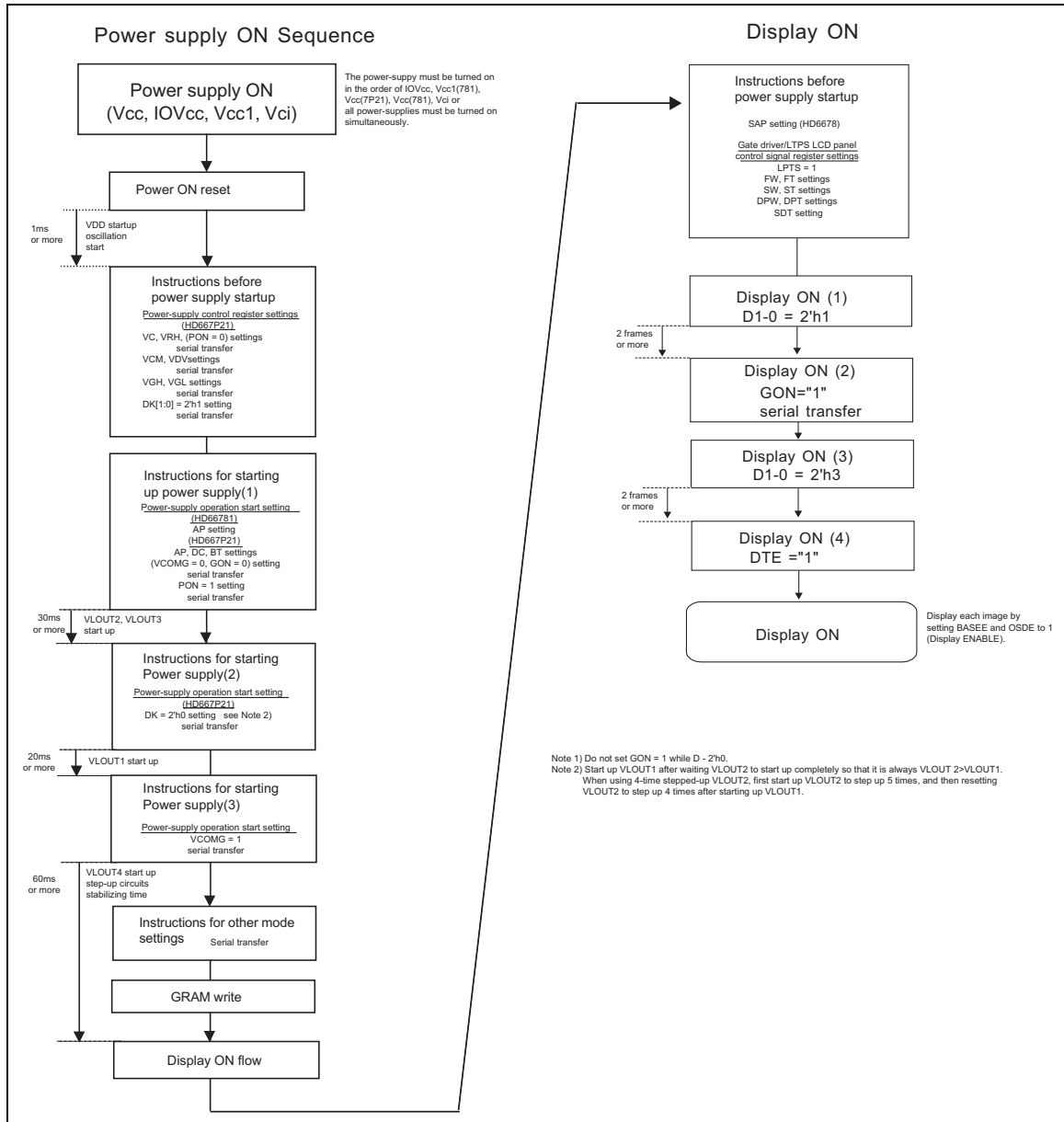

Power-supply/display OFF (LPTS = 1: LPTS TFT panel, with HD667P21)

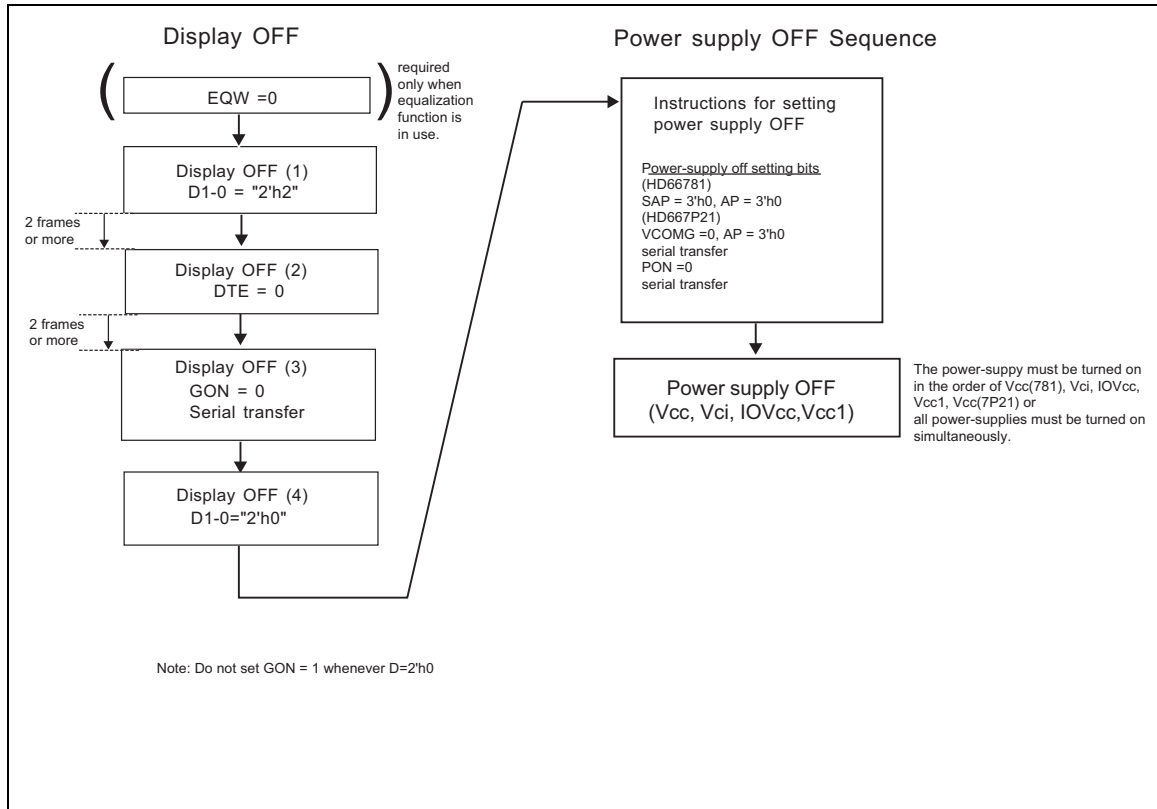

Standby/Sleep mode

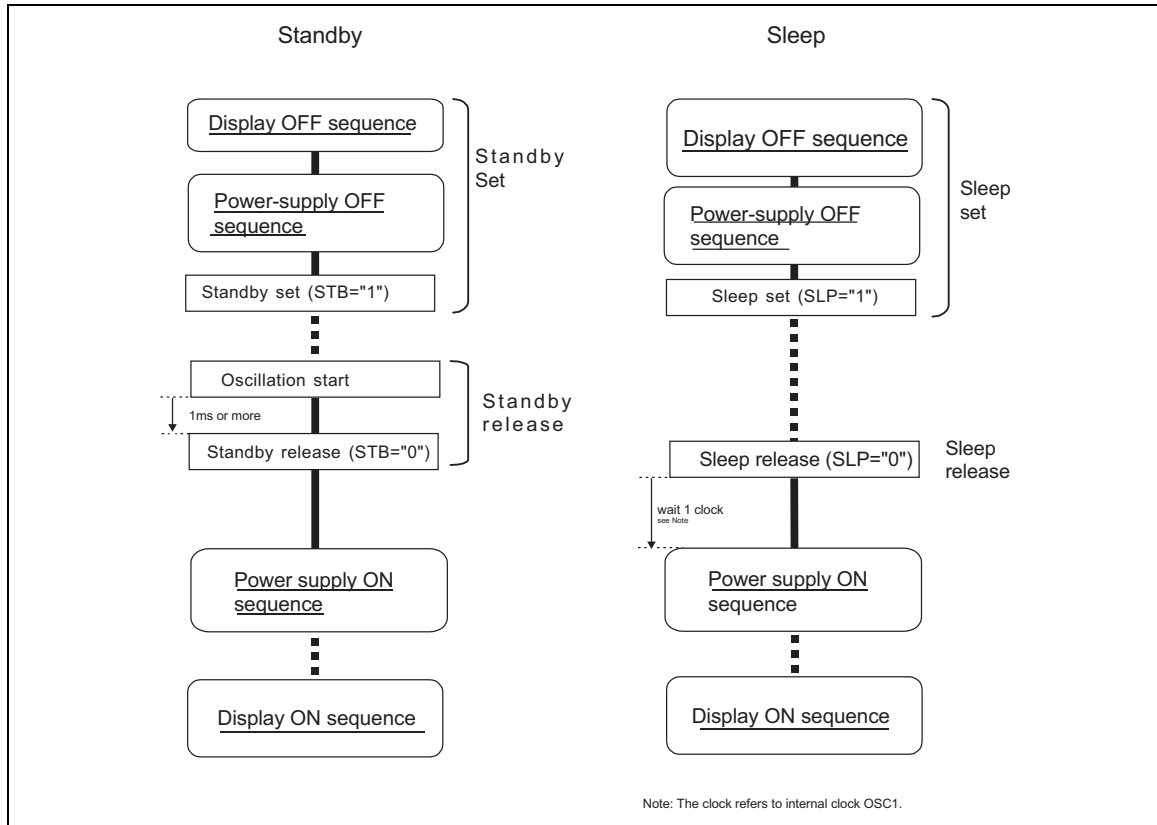

Deep standby mode

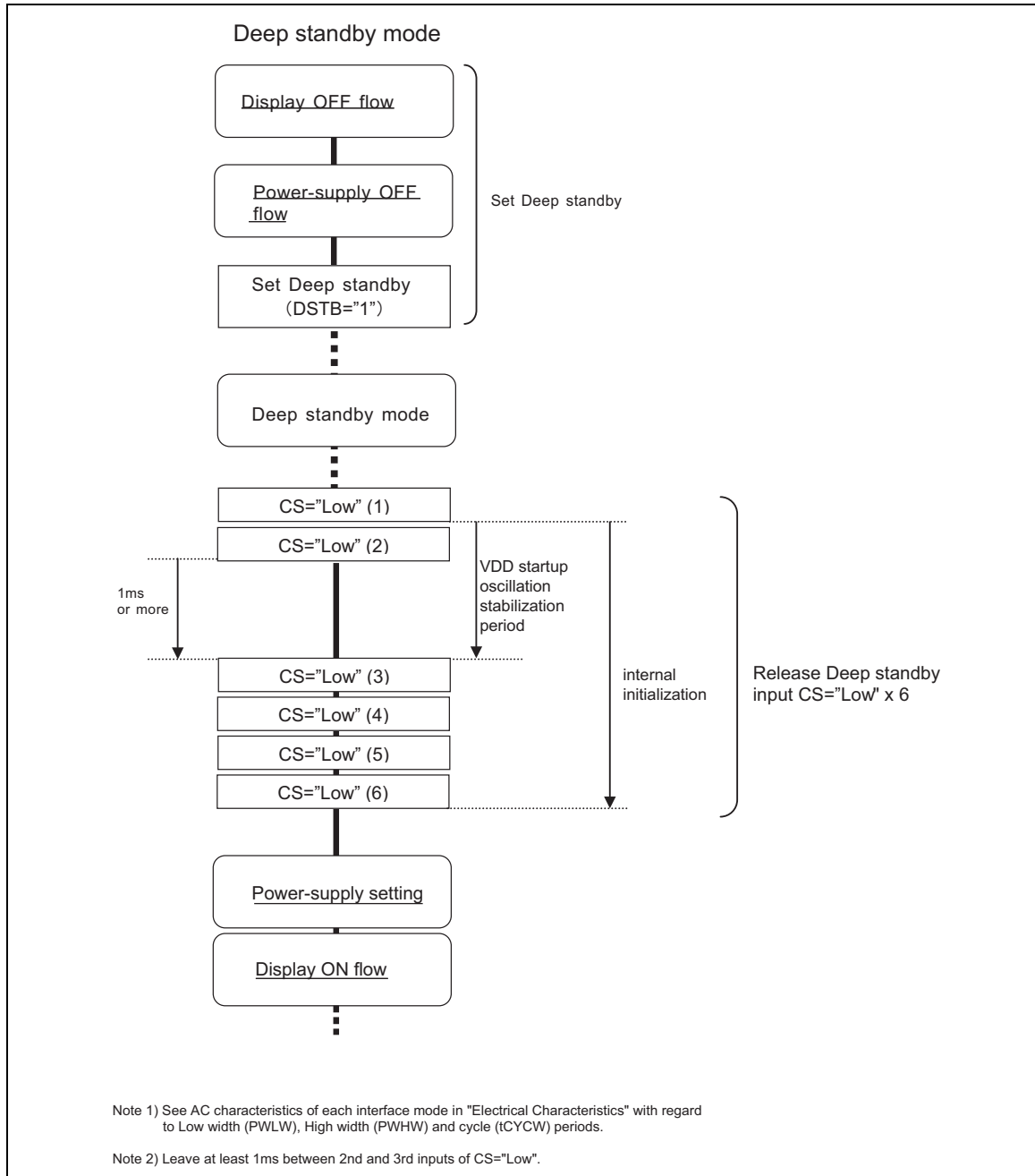

Low power consumption display mode

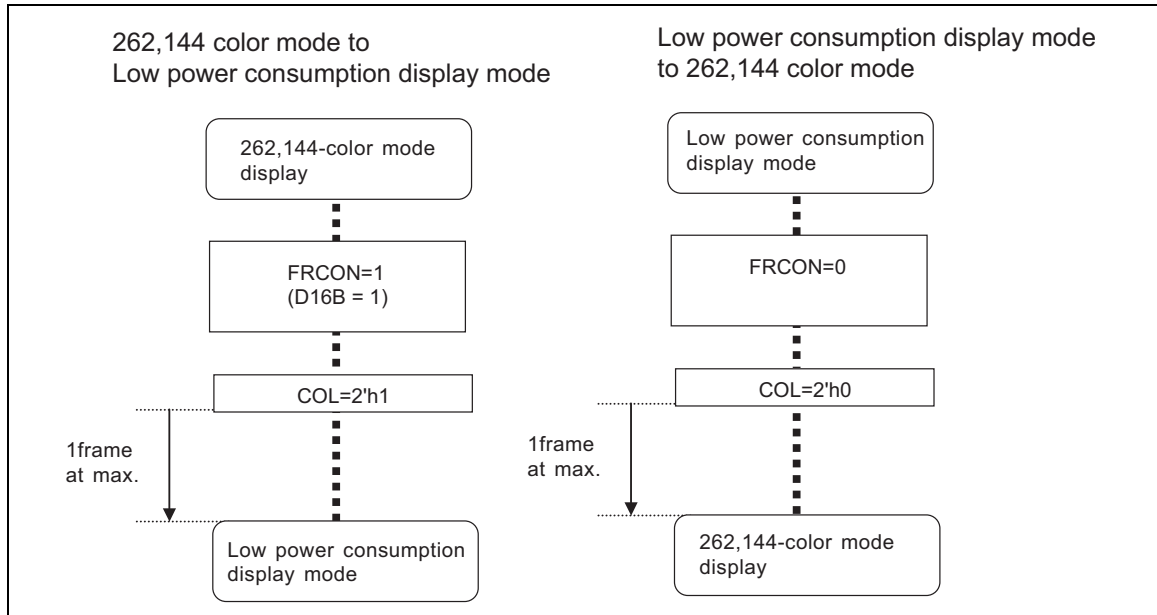

8-color mode

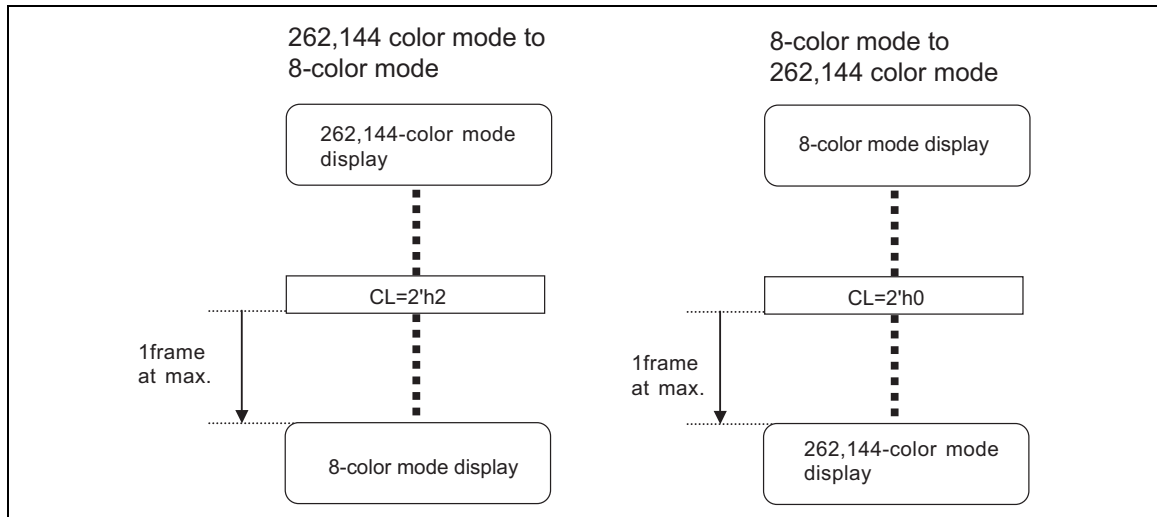

Partial display mode

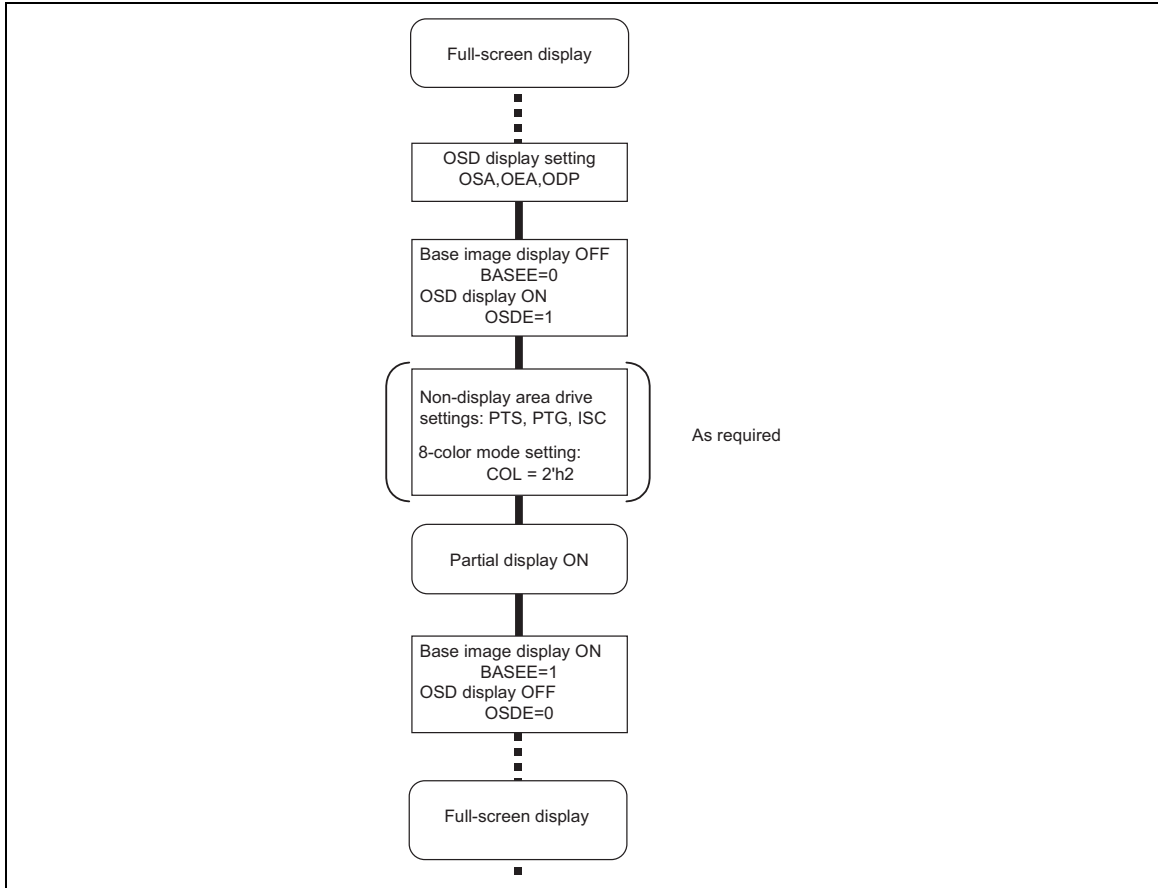

Absolute Maximum Values

Item	Symbol	Unit	Value	Notes
Power supply voltage (1)	IOVcc, Vcc1	V	-0.3 ~ + 4.6	1, 2, 5
Power supply voltage (2)	Vcc - GND	V	-0.3 ~ + 4.6	1, 3, 5
Power supply voltage (3)	DDVDH - GND	V	-0.3 ~ + 6.5	1, 4
Input voltage	Vt	V	-0.3 ~ Vcc + 0.3	1
Operating temperature	Topr	°C	-40 ~ + 85	1, 6

Note 1) The LSI may be permanently damaged if it is used under the condition exceeding the above absolute maximum values. It is also recommended to use the LSI within the limit of its electric characteristics during normal operation. Exceeding the conditions may lead to malfunction of LSI and affect its credibility.

Note 2) $IOVcc(High) \geq GND(Low)$, $Vcc1(High) \geq GND(Low)$ must be observed.

Note 3) $Vcc(High) \geq GND(Low)$ must be observed.

Note 4) $DDVDH(High) \geq GND(Low)$ must be observed.

Note 5) $Vcc(High) \geq IOVcc(Low)$, $Vcc(High) \geq Vcc1(Low)$ must be observed.

Note 6) The DC and AC characteristics of chip and wafer products are guaranteed at 85 °C.

Note 7) The electric potential of this LSI's substrate is GND. The electrical connection of the other side of the chip must be at the electric potential of an insulated state or GND. The electrical and operational characteristics of the LSI will not be guaranteed otherwise.

Renesas Technology Corp. Sales Strategic Planning Div. Nippon Bldg., 2-6-2, Ohte-machi, Chiyoda-ku, Tokyo 100-0004, Japan

Keep safety first in your circuit designs!

1. Renesas Technology Corporation puts the maximum effort into making semiconductor products better and more reliable, but there is always the possibility that trouble may occur with them. Trouble with semiconductors may lead to personal injury, fire or property damage.
Remember to give due consideration to safety when making your circuit designs, with appropriate measures such as (i) placement of substitutive, auxiliary circuits, (ii) use of nonflammable material or (iii) prevention against any malfunction or mishap.

Notes regarding these materials

1. These materials are intended as a reference to assist our customers in the selection of the Renesas Technology Corporation product best suited to the customer's application; they do not convey any license under any intellectual property rights, or any other rights, belonging to Renesas Technology Corporation or a third party.
 2. Renesas Technology Corporation assumes no responsibility for any damage, or infringement of any third-party's rights, originating in the use of any product data, diagrams, charts, programs, algorithms, or circuit application examples contained in these materials.
 3. All information contained in these materials, including product data, diagrams, charts, programs and algorithms represents information on products at the time of publication of these materials, and are subject to change by Renesas Technology Corporation without notice due to product improvements or other reasons. It is therefore recommended that customers contact Renesas Technology Corporation or an authorized Renesas Technology Corporation product distributor for the latest product information before purchasing a product listed herein.
The information described here may contain technical inaccuracies or typographical errors.
Renesas Technology Corporation assumes no responsibility for any damage, liability, or other loss rising from these inaccuracies or errors.
Please also pay attention to information published by Renesas Technology Corporation by various means, including the Renesas Technology Corporation Semiconductor home page (<http://www.renesas.com>).
 4. When using any or all of the information contained in these materials, including product data, diagrams, charts, programs, and algorithms, please be sure to evaluate all information as a total system before making a final decision on the applicability of the information and products. Renesas Technology Corporation assumes no responsibility for any damage, liability or other loss resulting from the information contained herein.
 5. Renesas Technology Corporation semiconductors are not designed or manufactured for use in a device or system that is used under circumstances in which human life is potentially at stake. Please contact Renesas Technology Corporation or an authorized Renesas Technology Corporation product distributor when considering the use of a product contained herein for any specific purposes, such as apparatus or systems for transportation, vehicular, medical, aerospace, nuclear, or undersea repeater use.
 6. The prior written approval of Renesas Technology Corporation is necessary to reprint or reproduce in whole or in part these materials.
 7. If these products or technologies are subject to the Japanese export control restrictions, they must be exported under a license from the Japanese government and cannot be imported into a country other than the approved destination.
Any diversion or reexport contrary to the export control laws and regulations of Japan and/or the country of destination is prohibited.
 8. Please contact Renesas Technology Corporation for further details on these materials or the products contained therein.
-



<http://www.renesas.com>

Copyright © 2003. Renesas Technology Corporation, All rights reserved. Printed in Japan.
Colophon 0.0

Revision Record

Rev.	Date	Contents of Modification	Drawn by	Approved by
0.5	2003, July 31	First issue		
