

DESCRIPTION

2SC2933 is silicon NPN epitaxial planar type transistor specifically designed for power amplifiers in 800 ~ 940MHz band.

FEATURES

- High gain, High efficiency:
 $G_{pb} = 6.7\text{dB}$, $\eta_c \geq 50\%$, $P_o \geq 14\text{W}$
@f = 900MHz, $V_{CC} = 12.5\text{V}$, $P_{in} = 3\text{W}$
- Gold metalization of transistor die.
- Flange type ceramic package.
- Equivalent input/output series impedance:
 $Z_{in} = 2.5 + j0.75(\Omega)$, $Z_{out} = 2.2 - j2.1(\Omega)$
@f = 900MHz, $V_{CC} = 12.5\text{V}$, $P_o = 16\text{W}$
- Common base type.
- The ability withstand infruite VSWR when operated at
f = 900MHz $V_{CC} = 15.2\text{V}$, $P_o = 14\text{W}$.

APPLICATION

Output stage of power amplifiers in 800MHz band mobile radio equipment

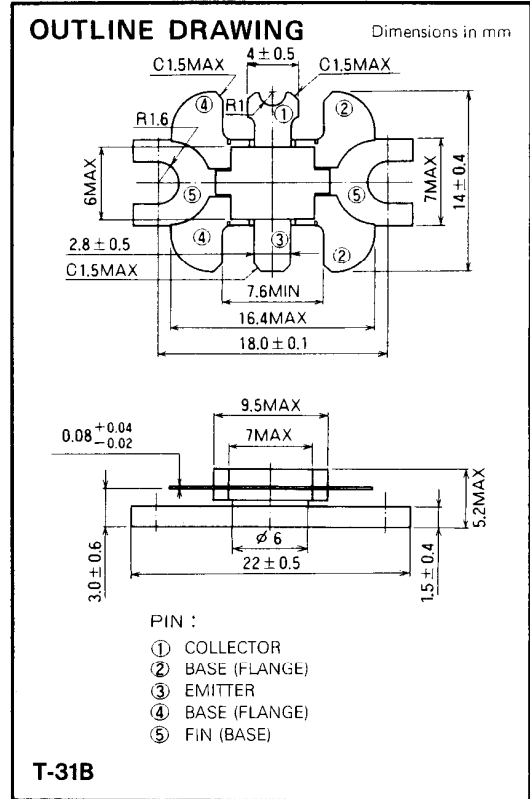

ABSOLUTE MAXIMUM RATINGS ($T_0 = 25^\circ\text{C}$ unless otherwise specified)

Symbol	Parameter	Conditions	Rating	Unit
V_{CBO}	Collector to base voltage		35	V
V_{EBO}	Emitter to base voltage		3	V
V_{CEO}	Collector to emitter voltage	$R_{BE} = \infty$	17	V
I_C	Collector current		4	A
P_C	Collector dissipation	$T_a = 25^\circ\text{C}$	3	W
		$T_0 = 25^\circ\text{C}$	40	W
T_J	Junction temperature		175	$^\circ\text{C}$
T_{stg}	Storage temperature		-55 to 175	$^\circ\text{C}$
R_{th-a}	Thermal resistance		50	$^\circ\text{C}/\text{W}$
R_{th-c}			3.75	$^\circ\text{C}/\text{W}$

Note. Above parameters are guaranteed independently.

ELECTRICAL CHARACTERISTICS ($T_0 = 25^\circ\text{C}$ unless otherwise specified)

Symbol	Parameter	Test conditions	Limits			Unit
			Min	Typ	Max	
$V_{(BR)EBO}$	Emitter to base breakdown voltage	$I_E = 10\text{mA}$, $I_C = 0$	3			V
$V_{(BR)CBO}$	Collector to base breakdown voltage	$I_C = 10\text{mA}$, $I_E = 0$	35			V
$V_{(BR)CEO}$	Collector to emitter breakdown voltage	$I_C = 0.1\text{A}$, $R_{BE} = \infty$	17			V
I_{CBO}	Collector cutoff current	$V_{CB} = 15\text{V}$, $I_E = 0$			2	mA
I_{EBO}	Emitter cutoff current	$V_{EB} = 2\text{V}$, $I_C = 0$			3	mA
h_{FE}	DC current gain *	$V_{CE} = 10\text{V}$, $I_C = 0.2\text{A}$	10	50	180	—
P_O	Output power	$f = 900\text{MHz}$, $V_{CC} = 12.5\text{V}$, $P_{in} = 3\text{W}$	14	16		W
η_C	Collector efficiency		50	60		%

Note. * Pulse test, $P_W = 150\mu\text{s}$, duty = 5%.
Above parameters, ratings, limits and conditions are subject to change.

TEST CIRCUIT

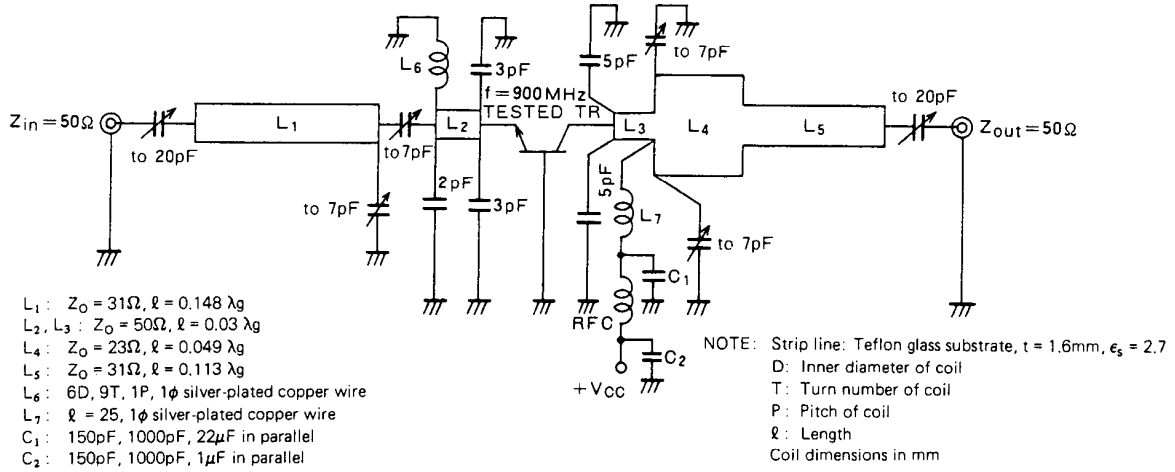

TYPICAL PERFORMANCE DATA

COLLECTOR DISSIPATION VS. AMBIENT TEMPERATURE

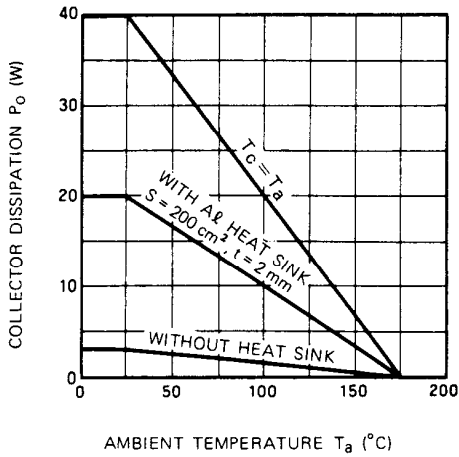

COLLECTOR TO EMITTER BREAKDOWN VOLTAGE VS. BASE TO EMITTER RESISTANCE

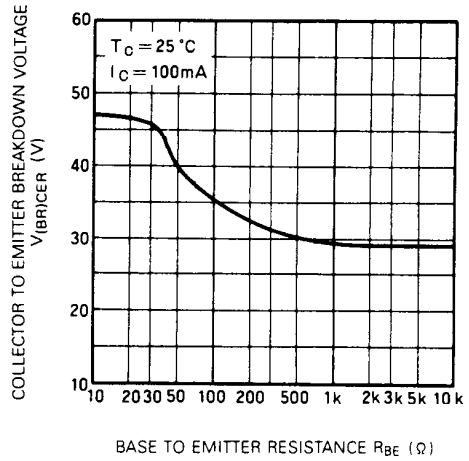

DC CURRENT GAIN VS. COLLECTOR CURRENT

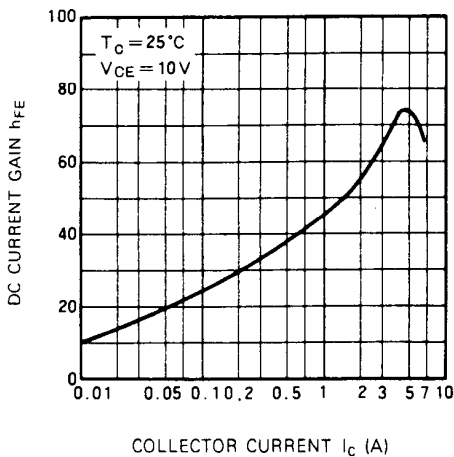

COLLECTOR OUTPUT CAPACITANCE VS. COLLECTOR TO BASE VOLTAGE

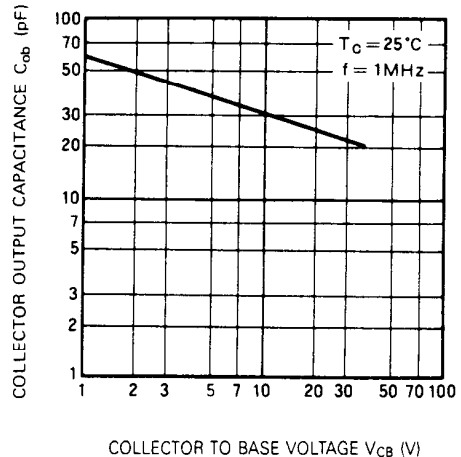

OUTPUT POWER, COLLECTOR EFFICIENCY VS. INPUT POWER

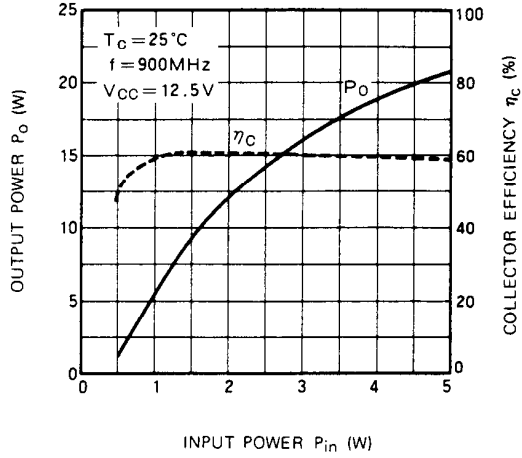

OUTPUT POWER, COLLECTOR SUPPLY VOLTAGE VARIATION

