

NCP300, NCP301

Voltage Detector Series

The NCP300 and NCP301 series are second generation ultra-low current voltage detectors. These devices are specifically designed for use as reset controllers in portable microprocessor based systems where extended battery life is paramount.

Each series features a highly accurate under voltage detector with hysteresis which prevents erratic system reset operation as the comparator threshold is crossed.

The NCP300 series consists of complementary output devices that are available with either an active high or active low reset output. The NCP301 series has an open drain N-channel output with either an active high or active low reset output.

The NCP300 and NCP301 device series are available in the TSOP-5 package with seven standard under voltage thresholds. Additional thresholds that range from 0.9 V to 4.9 V in 100 mV steps can be manufactured.

Features

- Quiescent Current of 0.5 μ A Typical
- High Accuracy Under Voltage Threshold of 2.0%
- Wide Operating Voltage Range of 0.8 V to 10 V
- Complementary or Open Drain Reset Output
- Active Low or Active High Reset Output

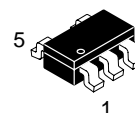
Typical Applications

- Microprocessor Reset Controller
- Low Battery Detection
- Power Fail Indicator
- Battery Backup Detection



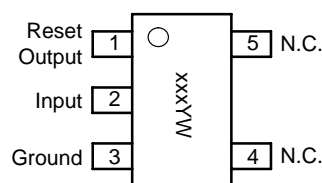
ON Semiconductor

<http://onsemi.com>



**TSOP-5
SN SUFFIX
CASE 483**

PIN CONNECTIONS AND MARKING DIAGRAM

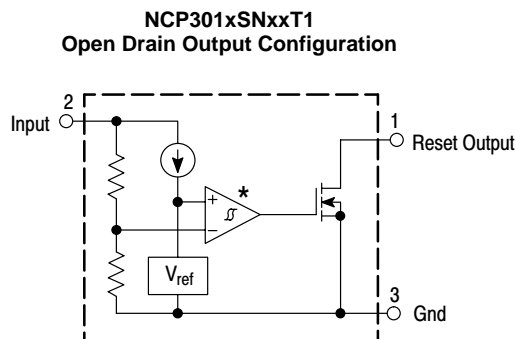
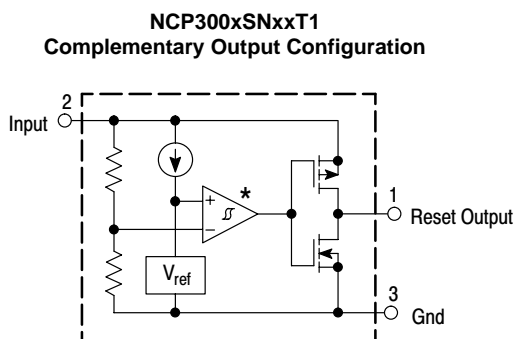


xxx = 300 or 301
Y = Year
W = Work Week
(Top View)

ORDERING INFORMATION

See detailed ordering and shipping information in the ordering information section on page 2 of this data sheet.

Representative Block Diagrams



* The representative block diagrams depict active low reset output 'L' suffix devices. The comparator inputs are interchanged for the active high output 'H' suffix devices.

This device contains 25 active transistors.

NCP300, NCP301

ORDERING INFORMATION

Device	Threshold Voltage	Output Type	Reset	Marking	Package (Qty/Reel)
NCP300LSN09T1	0.9	CMOS	Active Low	SEJ	3000 Units on 7 inch Reel
NCP300LSN18T1	1.8			SFK	
NCP300LSN20T1	2.0			SEH	
NCP300LSN27T1	2.7			SEE	
NCP300LSN30T1	3.0			SEC	
NCP300LSN45T1	4.5			SEA	
NCP300LSN47T1	4.7			SDZ	
NCP300HSN09T1	0.9		Active High	SDY	
NCP300HSN18T1	1.8			SFJ	
NCP300HSN20T1	2.0			SFI	
NCP300HSN27T1	2.7			SDU	
NCP300HSN30T1	3.0			SDS	
NCP300HSN45T1	4.5			SDQ	
NCP300HSN47T1	4.7			SDP	
NCP301LSN09T1	0.9	Open Drain	Active Low	SFF	3000 Units on 7 inch Reel
NCP301LSN18T1	1.8			SFN	
NCP301LSN20T1	2.0			SFD	
NCP301LSN27T1	2.7			SFA	
NCP301LSN30T1	3.0			SEY	
NCP301LSN45T1	4.5			SEV	
NCP301LSN47T1	4.7			SEU	
NCP301HSN09T1	0.9		Active High	SET	
NCP301HSN18T1	1.8			SFM	
NCP301HSN20T1	2.0			SFL	
NCP301HSN27T1	2.7			SEP	
NCP301HSN30T1	3.0			SEN	
NCP301HSN45T1	4.5			SEL	
NCP301HSN47T1	4.7			SEK	

NOTE: The ordering information lists seven standard under voltage thresholds with active low outputs. Additional active low threshold devices, ranging from 0.9 V to 4.9 V in 100 mV increments and NCP300/NCP301 active high output devices, ranging from 0.9 V to 4.9 V in 100 μ V increments can be manufactured. Contact your ON Semiconductor representative for availability. The electrical characteristics of these additional devices are shown in Tables 1 and 2.

MAXIMUM RATINGS

Rating	Symbol	Value	Unit
Input Power Supply Voltage (Pin 2)	V_{in}	12	V
Output Voltage (Pin 1) Complementary, NCP300 N-Channel Open Drain, NCP301	V_{OUT}	-0.3 to $V_{in}+0.3$ -0.3 to 12	V
Output Current (Pin 1, Note 2)	I_{OUT}	70	mA
Thermal Resistance Junction to Air	$R_{\theta JA}$	250	$^{\circ}C/W$
Operating Junction Temperature Range	T_J	-40 to +125	$^{\circ}C$
Storage Temperature Range	T_{stg}	-55 to +150	$^{\circ}C$

NOTES:

- This device series contains ESD protection and exceeds the following tests:
Human Body Model 2000 V per MIL-STD-883, Method 3015.
Machine Model Method 200 V.
- The maximum package power dissipation limit must not be exceeded.

$$P_D = \frac{T_{J(max)} - T_A}{R_{\theta JA}}$$

NCP300, NCP301

ELECTRICAL CHARACTERISTICS (For all values $T_A = 25^\circ\text{C}$, unless otherwise noted.)

Characteristic	Symbol	Min	Typ	Max	Unit
NCP300/1 – 0.9					
Detector Threshold (Pin 2, V_{in} Decreasing)	V_{DET-}	0.882	0.900	0.918	V
Detector Threshold Hysteresis (Pin 2, V_{in} Increasing)	V_{HYS}	0.027	0.045	0.063	V
Supply Current (Pin 2) ($V_{in} = 0.8\text{ V}$) ($V_{in} = 2.9\text{ V}$)	I_{in}	– –	0.20 0.45	0.6 1.2	μA
Maximum Operating Voltage (Pin 2)	$V_{in(max)}$	–	–	10	V
Minimum Operating Voltage (Pin 2) ($T_A = -40^\circ\text{C}$ to 85°C)	$V_{in(min)}$	– –	0.55 0.65	0.70 0.80	V
Reset Output Current (Pin 1, Active Low 'L' Suffix Devices) Nch Sink Current, NCP300, NCP301 ($V_{OUT} = 0.05\text{V}$, $V_{in} = 0.70\text{V}$) ($V_{OUT} = 0.50\text{V}$, $V_{in} = 0.85\text{V}$) Pch Source Current, NCP300 ($V_{OUT} = 2.4\text{V}$, $V_{in} = 4.5\text{V}$)	I_{OUT}	0.01 0.05 1.0	0.05 0.50 2.0	– – –	mA
Propagation Delay Input to Output (Figure 1) Complementary Output NCP300 Series Output Transition, High to Low Output Transition, Low to High N-Channel Open Drain NCP301 Series Output Transition, High to Low	t_{pHL} t_{pLH} t_{pHL}	– – –	97 77 97	– – –	μs

ELECTRICAL CHARACTERISTICS (For all values $T_A = 25^\circ\text{C}$, unless otherwise noted.)

Characteristic	Symbol	Min	Typ	Max	Unit
NCP300/1 – 1.8					
Detector Threshold (Pin 2, V_{in} Decreasing)	V_{DET-}	1.764	1.80	1.836	V
Detector Threshold Hysteresis (Pin 2, V_{in} Increasing)	V_{HYS}	0.054	0.090	0.126	V
Supply Current (Pin 2) ($V_{in} = 1.7\text{ V}$) ($V_{in} = 3.8\text{ V}$)	I_{in}	– –	0.23 0.48	0.7 1.3	μA
Maximum Operating Voltage (Pin 2)	$V_{in(max)}$	–	–	10	V
Minimum Operating Voltage (Pin 2) ($T_A = -40^\circ\text{C}$ to 85°C)	$V_{in(min)}$	– –	0.55 0.65	0.70 0.80	V
Reset Output Current (Pin 1, Active Low 'L' Suffix Devices) Nch Sink Current, NCP300, NCP301 ($V_{OUT} = 0.05\text{V}$, $V_{in} = 0.70\text{V}$) ($V_{OUT} = 0.50\text{V}$, $V_{in} = 1.5\text{V}$) Pch Source Current, NCP300 ($V_{OUT} = 2.4\text{V}$, $V_{in} = 4.5\text{V}$)	I_{OUT}	0.01 1.0 1.0	0.05 2.0 2.0	– – –	mA
Propagation Delay Input to Output (Figure 1) Complementary Output NCP300 Series Output Transition, High to Low Output Transition, Low to High N-Channel Open Drain NCP301 Series Output Transition, High to Low	t_{pHL} t_{pLH} t_{pHL}	– – –	73 94 73	– – –	μs

NCP300, NCP301

ELECTRICAL CHARACTERISTICS (For all values $T_A = 25^\circ\text{C}$, unless otherwise noted.)

Characteristic	Symbol	Min	Typ	Max	Unit
NCP300/1 – 2.0					
Detector Threshold (Pin 2, V_{in} Decreasing)	V_{DET-}	1.960	2.00	2.040	V
Detector Threshold Hysteresis (Pin 2, V_{in} Increasing)	V_{HYS}	0.06	0.10	0.14	V
Supply Current (Pin 2) ($V_{in} = 1.9\text{ V}$) ($V_{in} = 4.0\text{ V}$)	I_{in}	– –	0.23 0.48	0.8 1.3	μA
Maximum Operating Voltage (Pin 2)	$V_{in(max)}$	–	–	10	V
Minimum Operating Voltage (Pin 2) ($T_A = -40^\circ\text{C}$ to 85°C)	$V_{in(min)}$	– –	0.55 0.65	0.70 0.80	V
Reset Output Current (Pin 1, Active Low 'L' Suffix Devices) Nch Sink Current, NCP300, NCP301 ($V_{OUT} = 0.05\text{V}$, $V_{in} = 0.70\text{V}$) ($V_{OUT} = 0.50\text{V}$, $V_{in} = 1.5\text{V}$) Pch Source Current, NCP300 ($V_{OUT} = 2.4\text{V}$, $V_{in} = 4.5\text{V}$)	I_{OUT}	0.01 1.0 1.0	0.05 2.0 2.0	– – –	mA
Propagation Delay Input to Output (Figure 1) Complementary Output NCP300 Series Output Transition, High to Low Output Transition, Low to High N-Channel Open Drain NCP301 Series Output Transition, High to Low	t_{pHL} t_{pLH} t_{pHL}	– – –	55 108 55	– – –	μs

ELECTRICAL CHARACTERISTICS (For all values $T_A = 25^\circ\text{C}$, unless otherwise noted.)

Characteristic	Symbol	Min	Typ	Max	Unit
NCP300/1– 2.7					
Detector Threshold (Pin 2, V_{in} Decreasing)	V_{DET-}	2.646	2.700	2.754	V
Detector Threshold Hysteresis (Pin 2, V_{in} Increasing)	V_{HYS}	0.081	0.135	0.189	V
Supply Current (Pin 2) ($V_{in} = 2.6\text{ V}$) ($V_{in} = 4.7\text{ V}$)	I_{in}	– –	0.26 0.46	0.8 1.3	μA
Maximum Operating Voltage (Pin 2)	$V_{in(max)}$	–	–	10	V
Minimum Operating Voltage (Pin 2) ($T_A = -40^\circ\text{C}$ to 85°C)	$V_{in(min)}$	– –	0.55 0.65	0.70 0.80	V
Reset Output Current (Pin 1, Active Low 'L' Suffix Devices) Nch Sink Current, NCP300, NCP301 ($V_{OUT} = 0.05\text{V}$, $V_{in} = 0.70\text{V}$) ($V_{OUT} = 0.50\text{V}$, $V_{in} = 1.5\text{V}$) Pch Source Current, NCP300 ($V_{OUT} = 2.4\text{V}$, $V_{in} = 4.5\text{V}$)	I_{OUT}	0.01 1.0 1.0	0.05 2.0 2.0	– – –	mA
Propagation Delay Input to Output (Figure 1) Complementary Output NCP300 Series Output Transition, High to Low Output Transition, Low to High N-Channel Open Drain NCP301 Series Output Transition, High to Low	t_{pHL} t_{pLH} t_{pHL}	– – –	55 115 55	– – –	μs

NCP300, NCP301

ELECTRICAL CHARACTERISTICS (For all values $T_A = 25^\circ\text{C}$, unless otherwise noted.)

Characteristic	Symbol	Min	Typ	Max	Unit
NCP300/1 – 3.0					
Detector Threshold (Pin 2, V_{in} Decreasing)	V_{DET-}	2.94	3.00	3.06	V
Detector Threshold Hysteresis (Pin 2, V_{in} Increasing)	V_{HYS}	0.09	0.15	0.21	V
Supply Current (Pin 2) ($V_{in} = 2.87\text{ V}$) ($V_{in} = 5.0\text{ V}$)	I_{in}	– –	0.27 0.47	0.9 1.3	μA
Maximum Operating Voltage (Pin 2)	$V_{in(max)}$	–	–	10	V
Minimum Operating Voltage (Pin 2) ($T_A = -40^\circ\text{C}$ to 85°C)	$V_{in(min)}$	– –	0.55 0.65	0.70 0.80	V
Reset Output Current (Pin 1, Active Low 'L' Suffix Devices) Nch Sink Current, NCP300, NCP301 ($V_{OUT} = 0.05\text{V}$, $V_{in} = 0.70\text{V}$) ($V_{OUT} = 0.50\text{V}$, $V_{in} = 1.5\text{V}$) Pch Source Current, NCP300 ($V_{OUT} = 2.4\text{V}$, $V_{in} = 4.5\text{V}$)	I_{OUT}	0.01 1.0 1.0	0.05 2.0 2.0	– – –	mA
Propagation Delay Input to Output (Figure 1) Complementary Output NCP300 Series Output Transition, High to Low Output Transition, Low to High N-Channel Open Drain NCP301 Series Output Transition, High to Low	t_{pHL} t_{pLH} t_{pHL}	– – –	49 115 49	– – –	μs

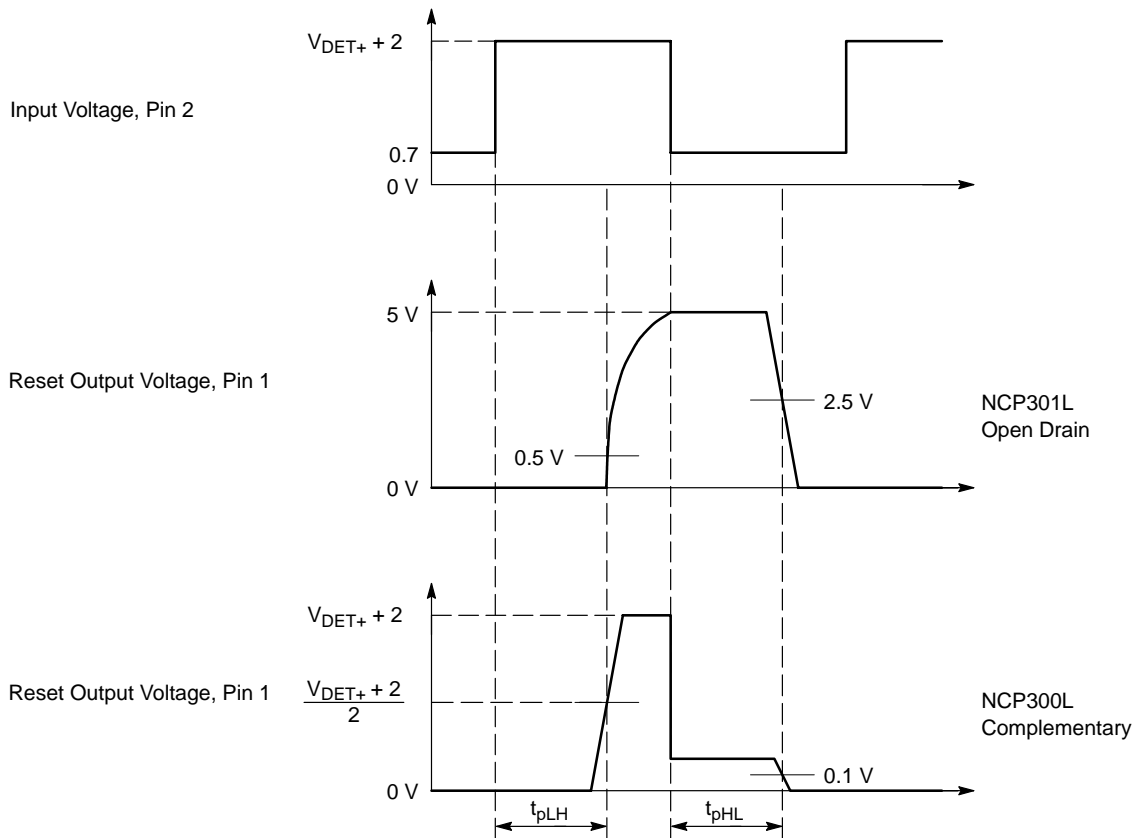
ELECTRICAL CHARACTERISTICS (For all values $T_A = 25^\circ\text{C}$, unless otherwise noted.)

Characteristic	Symbol	Min	Typ	Max	Unit
NCP300/1 – 4.5					
Detector Threshold (Pin 2, V_{in} Decreasing)	V_{DET-}	4.410	4.500	4.590	V
Detector Threshold Hysteresis (Pin 2, V_{in} Increasing)	V_{HYS}	0.135	0.225	0.315	V
Supply Current (Pin 2) ($V_{in} = 4.34\text{ V}$) ($V_{in} = 6.5\text{ V}$)	I_{in}	– –	0.33 0.52	1.0 1.4	μA
Maximum Operating Voltage (Pin 2)	$V_{in(max)}$	–	–	10	V
Minimum Operating Voltage (Pin 2) ($T_A = -40^\circ\text{C}$ to 85°C)	$V_{in(min)}$	– –	0.55 0.65	0.70 0.80	V
Reset Output Current (Pin 1, Active Low 'L' Suffix Devices) Nch Sink Current, NCP300, NCP301 ($V_{OUT} = 0.05\text{V}$, $V_{in} = 0.70\text{V}$) ($V_{OUT} = 0.50\text{V}$, $V_{in} = 1.5\text{V}$) Pch Source Current, NCP300 ($V_{OUT} = 5.9\text{V}$, $V_{in} = 8.0\text{V}$)	I_{OUT}	0.01 1.0 1.5	0.05 2.0 3.0	– – –	mA
Propagation Delay Input to Output (Figure 1) Complementary Output NCP300 Series Output Transition, High to Low Output Transition, Low to High N-Channel Open Drain NCP301 Series Output Transition, High to Low	t_{pHL} t_{pLH} t_{pHL}	– – –	49 130 49	– – –	μs

NCP300, NCP301

ELECTRICAL CHARACTERISTICS (For all values $T_A = 25^\circ\text{C}$, unless otherwise noted.)

Characteristic	Symbol	Min	Typ	Max	Unit
NCP300/1 – 4.7					
Detector Threshold (Pin 2, V_{in} Decreasing)	V_{DET-}	4.606	4.70	4.794	V
Detector Threshold Hysteresis (Pin 2, V_{in} Increasing)	V_{HYS}	0.141	0.235	0.329	V
Supply Current (Pin 2) ($V_{in} = 4.54\text{ V}$) ($V_{in} = 6.7\text{ V}$)	I_{in}	–	0.34 0.53	1.0 1.4	μA
Maximum Operating Voltage (Pin 2)	$V_{in(max)}$	–	–	10	V
Minimum Operating Voltage (Pin 2) ($T_A = -40^\circ\text{C}$ to 85°C)	$V_{in(min)}$	–	0.55 0.65	0.70 0.80	V
Reset Output Current (Pin 1, Active Low 'L' Suffix Devices) Nch Sink Current, NCP300, NCP301 ($V_{OUT} = 0.05\text{V}$, $V_{in} = 0.70\text{V}$) ($V_{OUT} = 0.50\text{V}$, $V_{in} = 1.5\text{V}$) Pch Source Current, NCP300 ($V_{OUT} = 5.9\text{V}$, $V_{in} = 8.0\text{V}$)	I_{OUT}	0.01 1.0 1.5	0.05 2.0 3.0	– – –	mA
Propagation Delay Input to Output (Figure 1) Complementary Output NCP300 Series Output Transition, High to Low Output Transition, Low to High N-Channel Open Drain NCP301 Series Output Transition, High to Low	t_{pHL} t_{pLH} t_{pHL}	– – –	45 130 45	– – –	μs



NCP300 and NCP301 series are measured with 10 pF capacitive load. NCP301 has an additional 470 k pullup resistor connected from the reset output to +5.0 V. Reset output voltage waveforms are shown for the active low 'L' devices. For active high 'H' devices, the reset output voltage waveforms are inverted. The upper detector threshold, V_{DET+} is the sum of the lower detector threshold, V_{DET-} plus the input hysteresis, V_{HYS} .

Figure 1. Propagation Delay Measurement Conditions

NCP300, NCP301

Table 1. ELECTRICAL CHARACTERISTIC TABLE FOR 0.9 – 4.9 V

NCP300 Series	Detector Threshold			Detector Threshold Hysteresis			Supply Current		Nch Sink Current		Pch Source Current
							V _{in} Low	V _{in} High	V _{in} Low	V _{in} High	
Part Number	V _{DET-} (V)			V _{HYS} (V)			I _{in} (μA) (1)	I _{in} (μA) (2)	I _{OUT} (mA) (3)	I _{OUT} (mA) (4)	I _{OUT} (mA) (5)
	Min	Typ	Max	Min	Typ	Max	Typ	Typ	Typ	Typ	Typ
NCP300(L/H)SN09T1	0.882	0.9	0.918	0.027	0.045	0.063	0.3	0.5	0.05	0.5	2.0
NCP300(L/H)SN10T1	0.980	1.0	1.020	0.030	0.050	0.070					
NCP300(L/H)SN11T1	1.078	1.1	1.122	0.033	0.055	0.077					
NCP300(L/H)SN12T1	1.176	1.2	1.224	0.036	0.060	0.084					
NCP300(L/H)SN13T1	1.274	1.3	1.326	0.039	0.065	0.091					
NCP300(L/H)SN14T1	1.372	1.4	1.428	0.042	0.070	0.098					
NCP300(L/H)SN15T1	1.470	1.5	1.530	0.045	0.075	0.105					
NCP300(L/H)SN16T1	1.568	1.6	1.632	0.048	0.080	0.112					
NCP300(L/H)SN17T1	1.666	1.7	1.734	0.051	0.085	0.119					
NCP300(L/H)SN18T1	1.764	1.8	1.836	0.054	0.090	0.126					
NCP300(L/H)SN19T1	1.862	1.9	1.938	0.057	0.095	0.133					
NCP300(L/H)SN20T1	1.960	2.0	2.040	0.060	0.100	0.140					
NCP300(L/H)SN21T1	2.058	2.1	2.142	0.063	0.105	0.147					
NCP300(L/H)SN22T1	2.156	2.2	2.244	0.066	0.110	0.154					
NCP300(L/H)SN23T1	2.254	2.3	2.346	0.069	0.115	0.161					
NCP300(L/H)SN24T1	2.352	2.4	2.448	0.072	0.120	0.168					
NCP300(L/H)SN25T1	2.450	2.5	2.550	0.075	0.125	0.175					
NCP300(L/H)SN26T1	2.548	2.6	2.652	0.078	0.130	0.182					
NCP300(L/H)SN27T1	2.646	2.7	2.754	0.081	0.135	0.189					
NCP300(L/H)SN28T1	2.744	2.8	2.856	0.084	0.140	0.196					
NCP300(L/H)SN29T1	2.842	2.9	2.958	0.087	0.145	0.203					
NCP300(L/H)SN30T1	2.940	3.0	3.060	0.090	0.150	0.210					
NCP300(L/H)SN31T1	3.038	3.1	3.162	0.093	0.155	0.217					
NCP300(L/H)SN32T1	3.136	3.2	3.264	0.096	0.160	0.224					
NCP300(L/H)SN33T1	3.234	3.3	3.366	0.099	0.165	0.231					
NCP300(L/H)SN34T1	3.332	3.4	3.468	0.102	0.170	0.238					
NCP300(L/H)SN35T1	3.430	3.5	3.570	0.105	0.175	0.245					
NCP300(L/H)SN36T1	3.528	3.6	3.672	0.108	0.180	0.252					
NCP300(L/H)SN37T1	3.626	3.7	3.774	0.111	0.185	0.259					
NCP300(L/H)SN38T1	3.724	3.8	3.876	0.114	0.190	0.266					
NCP300(L/H)SN39T1	3.822	3.9	3.978	0.117	0.195	0.273					
NCP300(L/H)SN40T1	3.920	4.0	4.080	0.120	0.200	0.280	0.4	0.6	0.05	0.5	3.0
NCP300(L/H)SN41T1	4.018	4.1	4.182	0.123	0.205	0.287					
NCP300(L/H)SN42T1	4.116	4.2	4.284	0.126	0.210	0.294					
NCP300(L/H)SN43T1	4.214	4.3	4.386	0.129	0.215	0.301					
NCP300(L/H)SN44T1	4.312	4.4	4.488	0.132	0.220	0.308					
NCP300(L/H)SN45T1	4.410	4.5	4.590	0.135	0.225	0.315					
NCP300(L/H)SN46T1	4.508	4.6	4.692	0.138	0.230	0.322					
NCP300(L/H)SN47T1	4.606	4.7	4.794	0.141	0.235	0.329					
NCP300(L/H)SN48T1	4.704	4.8	4.896	0.144	0.240	0.336					
NCP300(L/H)SN49T1	4.802	4.9	4.998	0.147	0.245	0.343					

(1) Condition 1: 0.9 – 2.9 V, V_{in} = V_{DET-} – 0.10 V; 3.0 – 3.9 V, V_{in} = V_{DET-} – 0.13 V; 4.0 – 4.9 V, V_{in} = V_{DET-} – 0.16 V

(2) Condition 2: 0.9 – 4.9 V, V_{in} = V_{DET-} + 2.0 V

(3) Condition 3: 0.9 – 4.9 V, V_{in} = 0.7 V, V_{OUT} = 0.05 V, Active Low 'L' Suffix Devices

(4) Condition 4: 0.9 – 1.0 V, V_{in} = 0.85 V, V_{OUT} = 0.5 V; 1.1 – 1.5 V, V_{in} = 1.0 V, V_{OUT} = 0.5 V; 1.6 – 4.9 V, V_{in} = 1.5 V, V_{OUT} = 0.5 V, Active Low 'L' Suffix Devices

(5) Condition 5: 0.9 – 3.9 V, V_{in} = 4.5 V, V_{OUT} = 2.4 V; 4.0 – 4.9 V, V_{in} = 8.0 V, V_{OUT} = 5.9 V

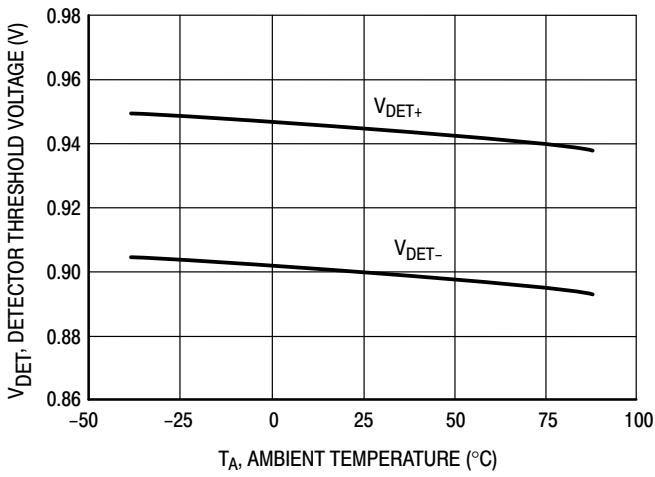
NCP300, NCP301

Table 2. ELECTRICAL CHARACTERISTIC TABLE FOR 0.9 – 4.9 V

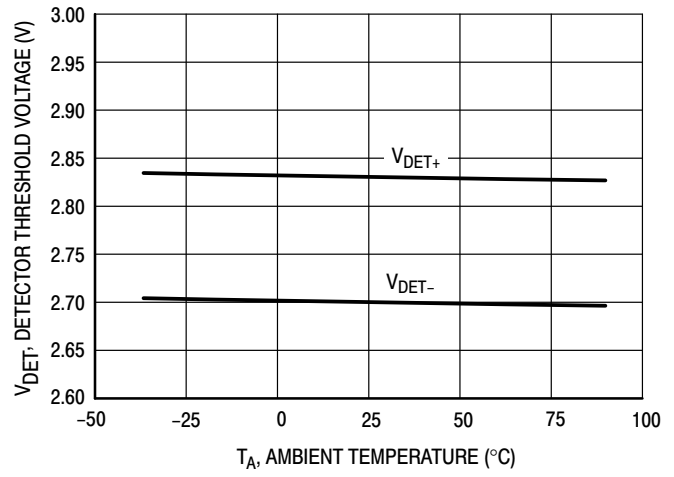
NCP301 Series	Detector Threshold			Detector Threshold Hysteresis			Supply Current		Nch Sink Current	
							V _{in} Low	V _{in} High	V _{in} Low	V _{in} High
Part Number	V _{DET-} (V)			V _{HYS} (V)			I _{in} (μA) (1)	I _{in} (μA) (2)	I _{OUT} (mA) (3)	I _{OUT} (mA) (4)
	Min	Typ	Max	Min	Typ	Max	Typ	Typ	Typ	Typ
NCP301(L/H)SN09T1	0.882	0.9	0.918	0.027	0.045	0.063	0.3	0.5	0.05	0.5
NCP301(L/H)SN10T1	0.980	1.0	1.020	0.030	0.050	0.070				1.0
NCP301(L/H)SN11T1	1.078	1.1	1.122	0.033	0.055	0.077				1.0
NCP301(L/H)SN12T1	1.176	1.2	1.224	0.036	0.060	0.084				1.0
NCP301(L/H)SN13T1	1.274	1.3	1.326	0.039	0.065	0.091				1.0
NCP301(L/H)SN14T1	1.372	1.4	1.428	0.042	0.070	0.098				1.0
NCP301(L/H)SN15T1	1.470	1.5	1.530	0.045	0.075	0.105				1.0
NCP301(L/H)SN16T1	1.568	1.6	1.632	0.048	0.080	0.112				1.0
NCP301(L/H)SN17T1	1.666	1.7	1.734	0.051	0.085	0.119				1.0
NCP301(L/H)SN18T1	1.764	1.8	1.836	0.054	0.090	0.126				1.0
NCP301(L/H)SN19T1	1.862	1.9	1.938	0.057	0.095	0.133			1.0	
NCP301(L/H)SN20T1	1.960	2.0	2.040	0.060	0.100	0.140			1.0	
NCP301(L/H)SN21T1	2.058	2.1	2.142	0.063	0.105	0.147			1.0	
NCP301(L/H)SN22T1	2.156	2.2	2.244	0.066	0.110	0.154			1.0	
NCP301(L/H)SN23T1	2.254	2.3	2.346	0.069	0.115	0.161			1.0	
NCP301(L/H)SN24T1	2.352	2.4	2.448	0.072	0.120	0.168			1.0	
NCP301(L/H)SN25T1	2.450	2.5	2.550	0.075	0.125	0.175			1.0	
NCP301(L/H)SN26T1	2.548	2.6	2.652	0.078	0.130	0.182			1.0	
NCP301(L/H)SN27T1	2.646	2.7	2.754	0.081	0.135	0.189			1.0	
NCP301(L/H)SN28T1	2.744	2.8	2.856	0.084	0.140	0.196			1.0	
NCP301(L/H)SN29T1	2.842	2.9	2.958	0.087	0.145	0.203	1.0			
NCP301(L/H)SN30T1	2.940	3.0	3.060	0.090	0.150	0.210	1.0			
NCP301(L/H)SN31T1	3.038	3.1	3.162	0.093	0.155	0.217	1.0			
NCP301(L/H)SN32T1	3.136	3.2	3.264	0.096	0.160	0.224	1.0			
NCP301(L/H)SN33T1	3.234	3.3	3.366	0.099	0.165	0.231	1.0			
NCP301(L/H)SN34T1	3.332	3.4	3.468	0.102	0.170	0.238	1.0			
NCP301(L/H)SN35T1	3.430	3.5	3.570	0.105	0.175	0.245	1.0			
NCP301(L/H)SN36T1	3.528	3.6	3.672	0.108	0.180	0.252	1.0			
NCP301(L/H)SN37T1	3.626	3.7	3.774	0.111	0.185	0.259	1.0			
NCP301(L/H)SN38T1	3.724	3.8	3.876	0.114	0.190	0.266	1.0			
NCP301(L/H)SN39T1	3.822	3.9	3.978	0.117	0.195	0.273	1.0			
NCP301(L/H)SN40T1	3.920	4.0	4.080	0.120	0.200	0.280	0.4	0.6	0.05	0.5
NCP301(L/H)SN41T1	4.018	4.1	4.182	0.123	0.205	0.287				0.5
NCP301(L/H)SN42T1	4.116	4.2	4.284	0.126	0.210	0.294				0.5
NCP301(L/H)SN43T1	4.214	4.3	4.386	0.129	0.215	0.301				0.5
NCP301(L/H)SN44T1	4.312	4.4	4.488	0.132	0.220	0.308				0.5
NCP301(L/H)SN45T1	4.410	4.5	4.590	0.135	0.225	0.315				0.5
NCP301(L/H)SN46T1	4.508	4.6	4.692	0.138	0.230	0.322				0.5
NCP301(L/H)SN47T1	4.606	4.7	4.794	0.141	0.235	0.329				0.5
NCP301(L/H)SN48T1	4.704	4.8	4.896	0.144	0.240	0.336				0.5
NCP301(L/H)SN49T1	4.802	4.9	4.998	0.147	0.245	0.343				0.5

(1) Condition 1: 0.9 – 2.9 V, V_{in} = V_{DET-} – 0.10 V; 3.0 – 3.9 V, V_{in} = V_{DET-} – 0.13 V; 4.0 – 4.9 V, V_{in} = V_{DET-} – 0.16 V
(2) Condition 2: 0.9 – 4.9 V, V_{in} = V_{DET-} + 2.0 V
(3) Condition 3: 0.9 – 4.9 V, V_{in} = 0.7 V, V_{OUT} = 0.05 V, Active Low 'L' Suffix Devices
(4) Condition 4: 0.9 – 1.0 V, V_{in} = 0.85 V, V_{OUT} = 0.5 V; 1.1 – 1.5 V, V_{in} = 1.0 V, V_{OUT} = 0.5 V; 1.6 – 4.9 V, V_{in} = 1.5 V, V_{OUT} = 0.5 V, Active Low 'L' Suffix Devices

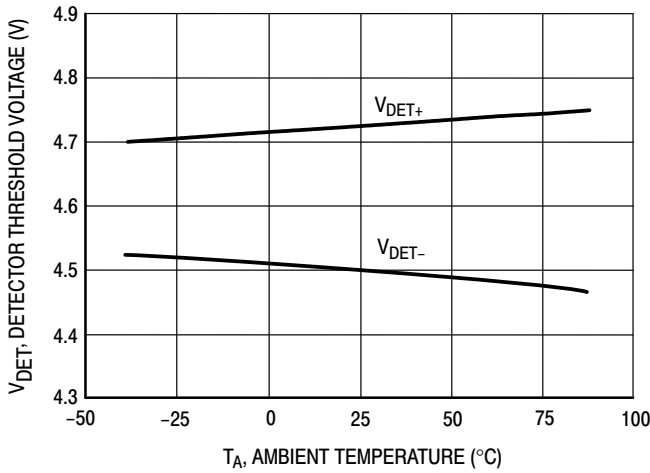
NCP300, NCP301



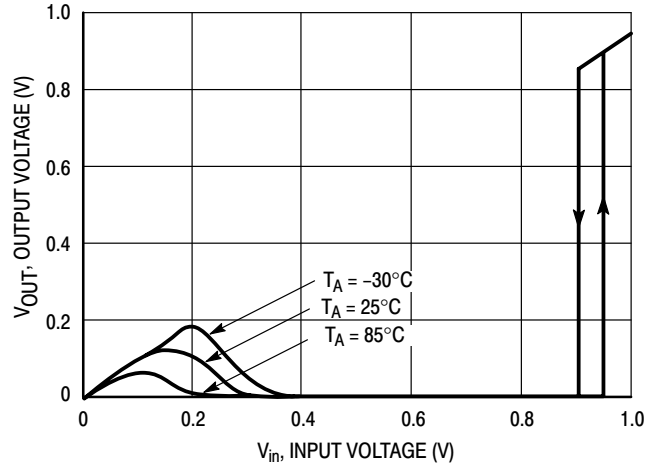
**Figure 2. NCP300/1 Series 0.9 V
Detector Threshold Voltage versus Temperature**



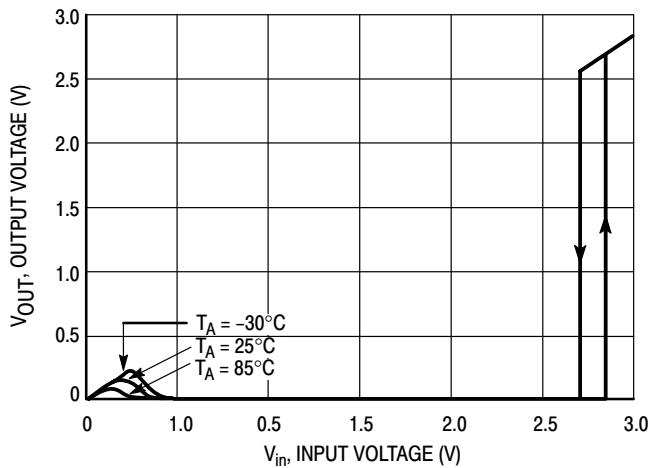
**Figure 3. NCP300/1 Series 2.7 V
Detector Threshold Voltage versus Temperature**



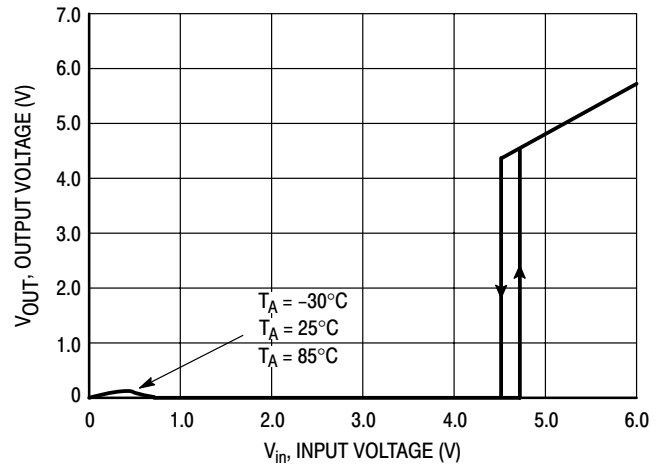
**Figure 4. NCP300/1 Series 4.5 V
Detector Threshold Voltage versus Temperature**



**Figure 5. NCP300L/1L Series 0.9 V
Reset Output Voltage versus Input Voltage**

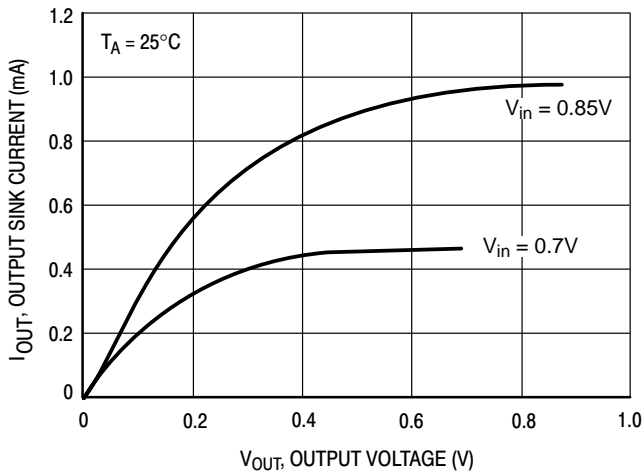


**Figure 6. NCP300L/1L Series 2.7 V
Reset Output Voltage versus Input Voltage**

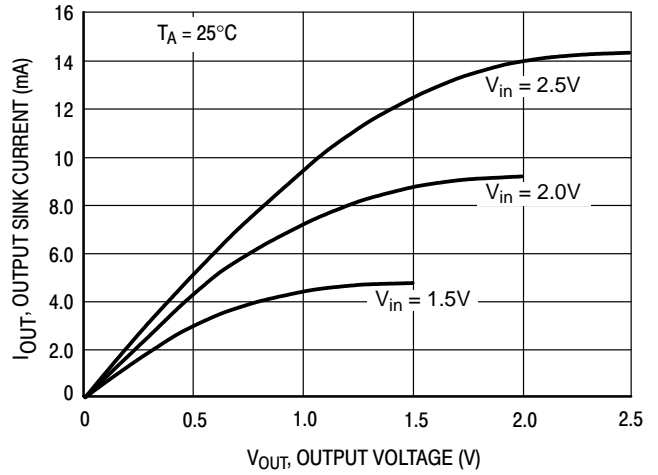


**Figure 7. NCP300L/1L Series 4.5 V
Reset Output Voltage versus Input Voltage**

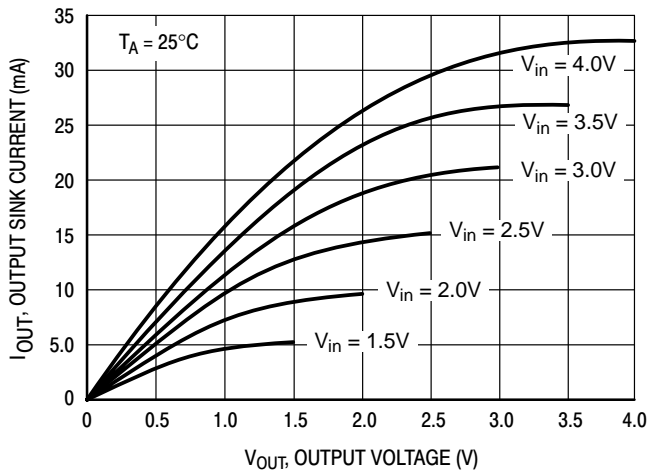
NCP300, NCP301



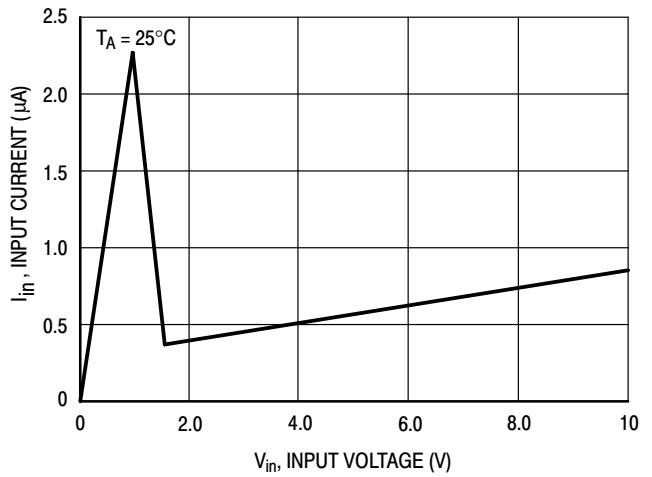
**Figure 8. NCP300L/1L Series 0.9 V
Reset Output Sink Current versus Output Voltage**



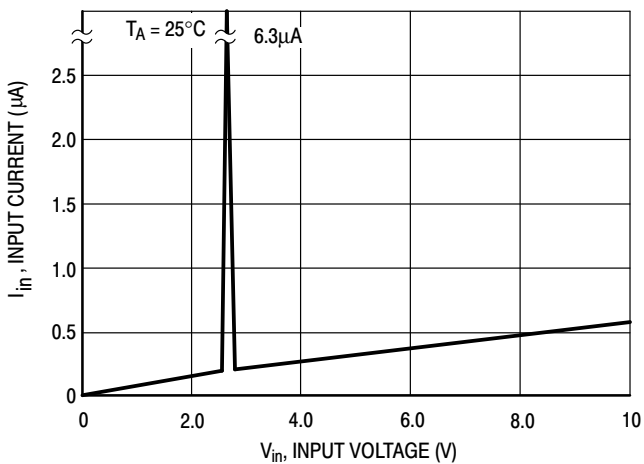
**Figure 9. NCP300L/1L Series 2.7 V
Reset Output Sink Current versus Output Voltage**



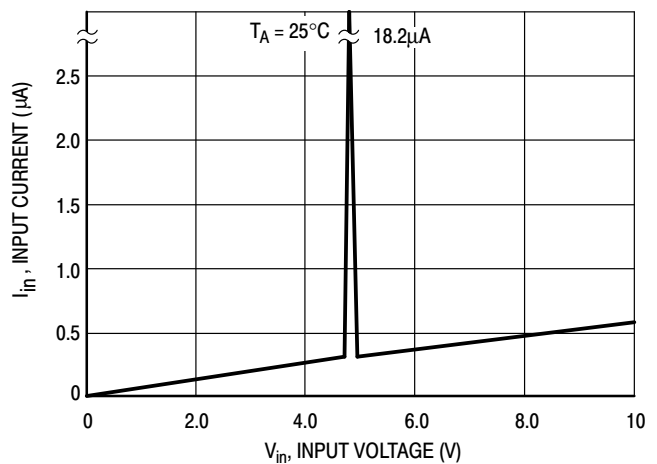
**Figure 10. NCP300L/1L Series 4.5 V
Reset Output Sink Current versus Output Voltage**



**Figure 11. NCP300/1 Series 0.9 V
Input Current versus Input Voltage**



**Figure 12. NCP300/1 Series 2.7 V
Input Current versus Input Voltage**



**Figure 13. NCP300/1 Series 4.5 V
Input Current versus Input Voltage**

NCP300, NCP301

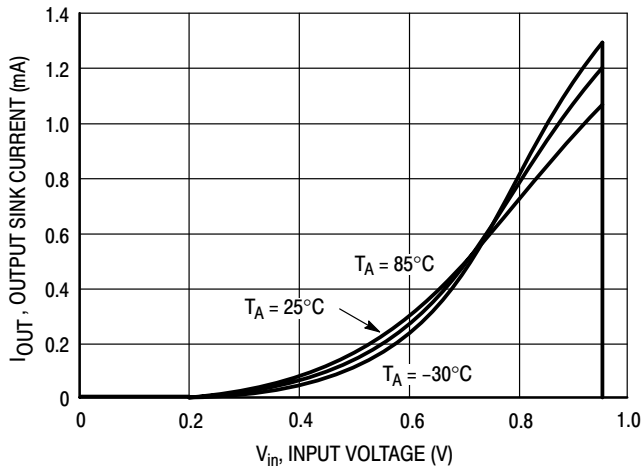


Figure 14. NCP300L/1L Series 0.9 V Reset Output Sink Current versus Input Voltage

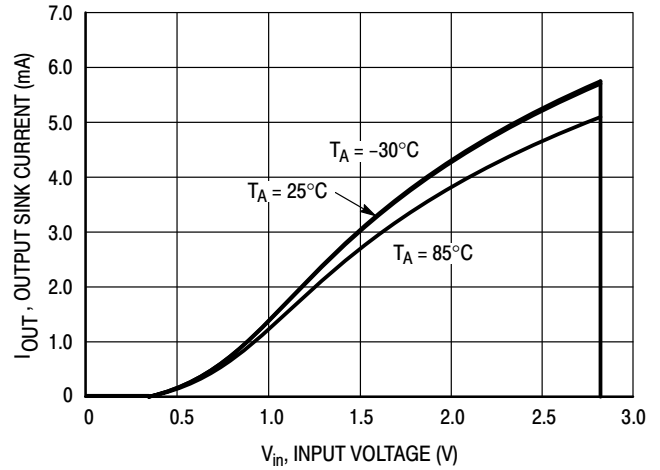


Figure 15. NCP300L/1L Series 2.7 V Reset Output Sink Current versus Input Voltage

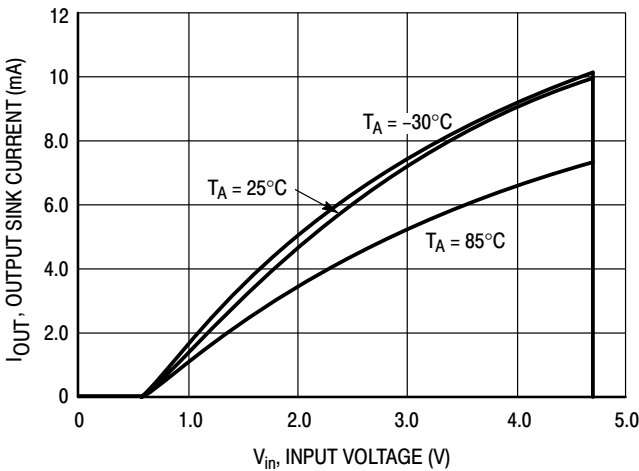


Figure 16. NCP300L/1L Series 4.5 V Reset Output Sink Current versus Input Voltage

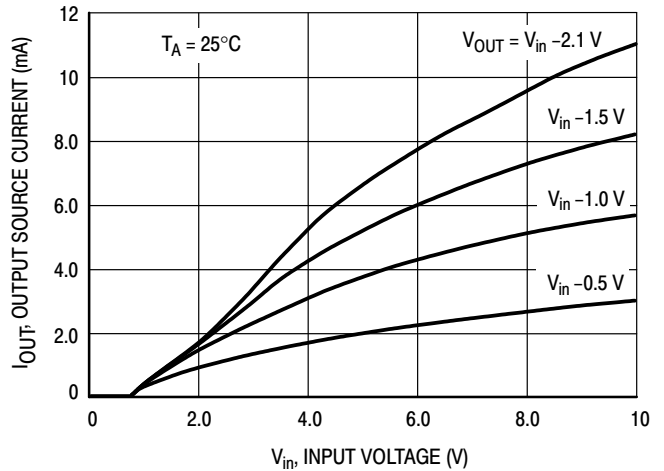


Figure 17. NCP300L Series 0.9 V Reset Output Source Current versus Input Voltage

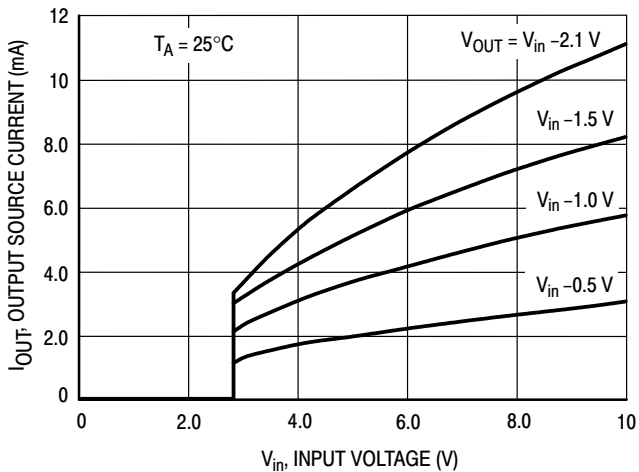


Figure 18. NCP300L Series 2.7 V Reset Output Source Current versus Input Voltage

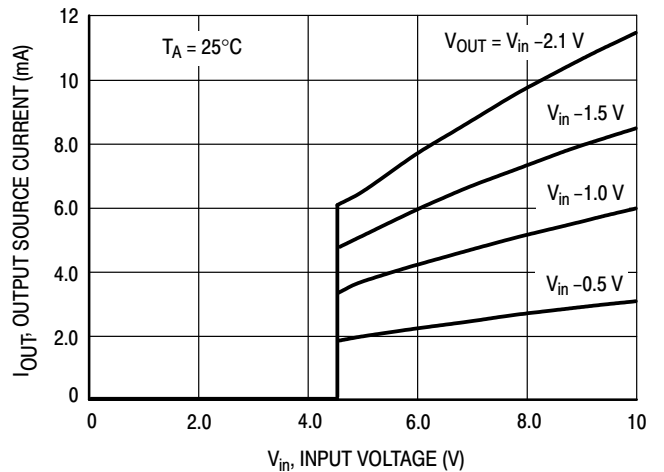


Figure 19. NCP300L Series 4.5 V Reset Output Source Current versus Input Voltage

NCP300, NCP301

OPERATING DESCRIPTION

The NCP300 and NCP301 series devices are second generation ultra-low current voltage detectors. Figures 20 and 21 show a timing diagram and a typical application. Initially consider that input voltage V_{in} is at a nominal level and it is greater than the voltage detector upper threshold (V_{DET+}), and the reset output (Pin 1) will be in the high state for active low devices, or in the low state for active high devices. If there is a power interruption and V_{in} becomes significantly deficient, it will fall below the lower detector threshold (V_{DET-}). This sequence of events causes the Reset output to be in the low state for active low devices, or in the

high state for active high devices. After completion of the power interruption, V_{in} will again return to its nominal level and become greater than the V_{DET+} . The voltage detector has built-in hysteresis to prevent erratic reset operation as the comparator threshold is crossed.

Although these device series are specifically designed for use as reset controllers in portable microprocessor based systems, they offer a cost-effective solution in numerous applications where precise voltage monitoring is required. Figure 21 through Figure 24 shows various application examples.

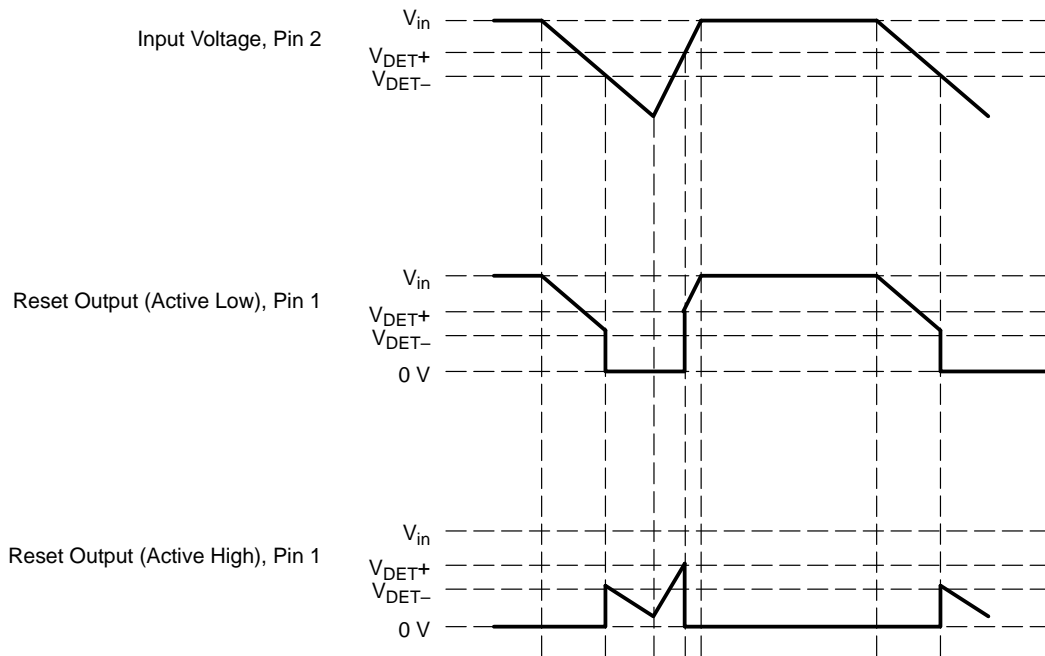


Figure 20. Timing Waveforms

NCP300, NCP301

APPLICATION CIRCUIT INFORMATION

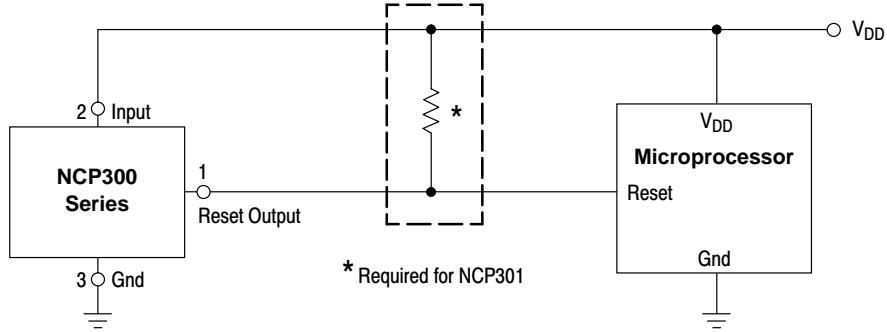


Figure 21. Microprocessor Reset Circuit (NCP300 and NCP301 Series)

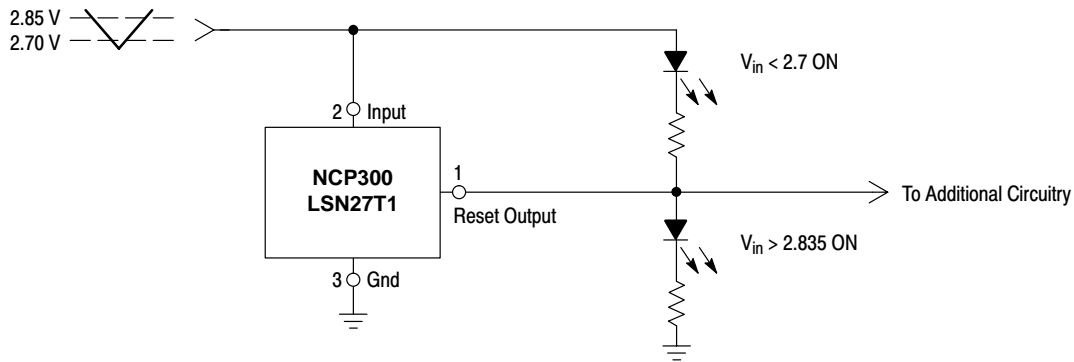


Figure 22. Battery Charge Indicator (NCP300 Series)

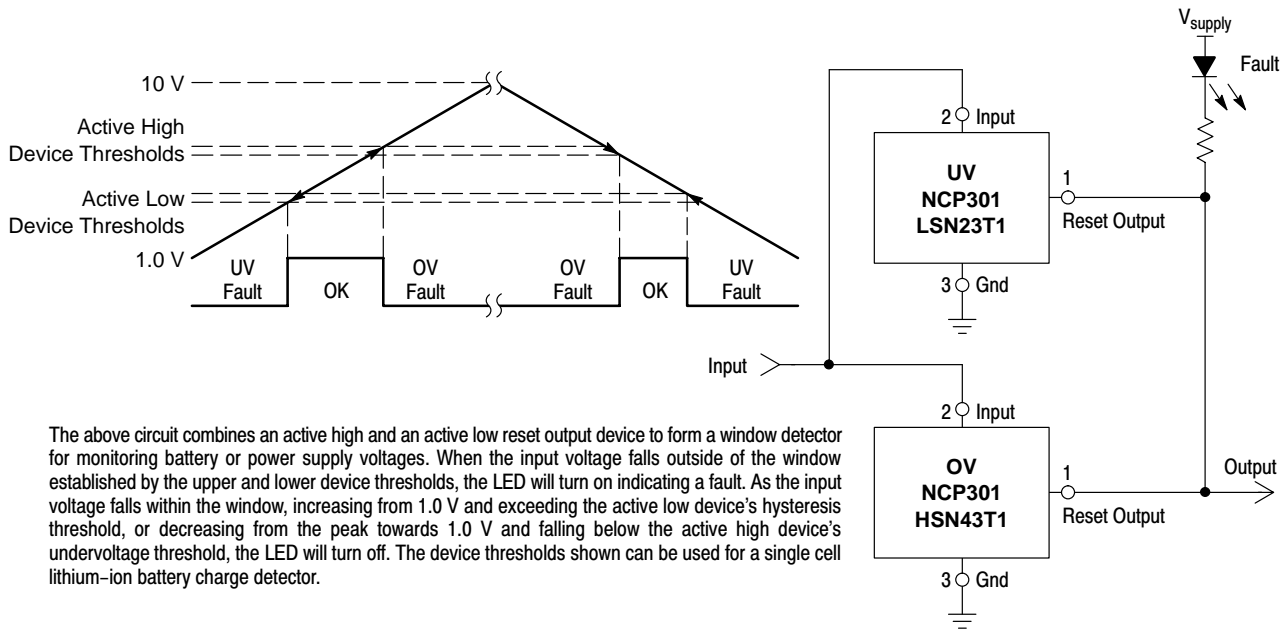


Figure 23. Window Voltage Detector

NCP300, NCP301

APPLICATION CIRCUIT INFORMATION

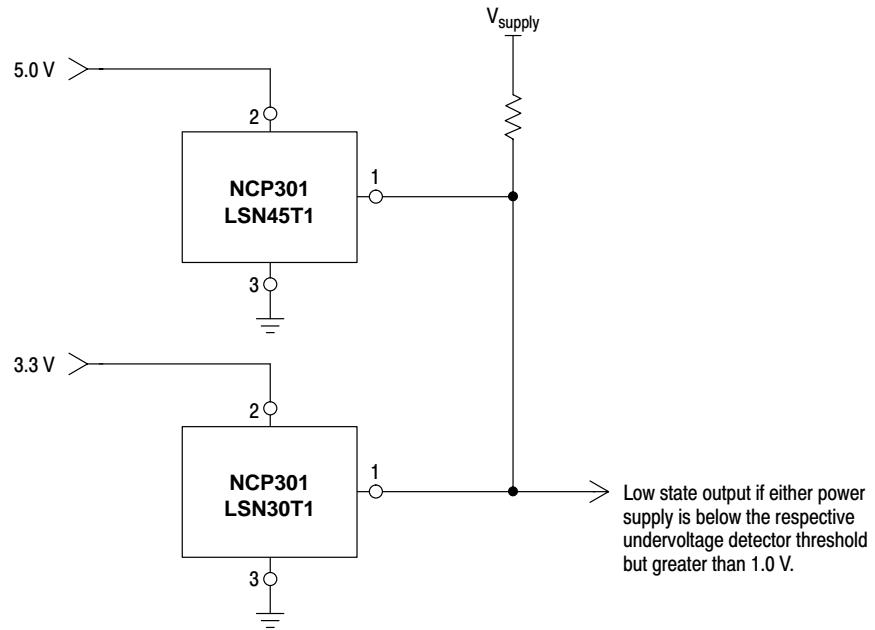


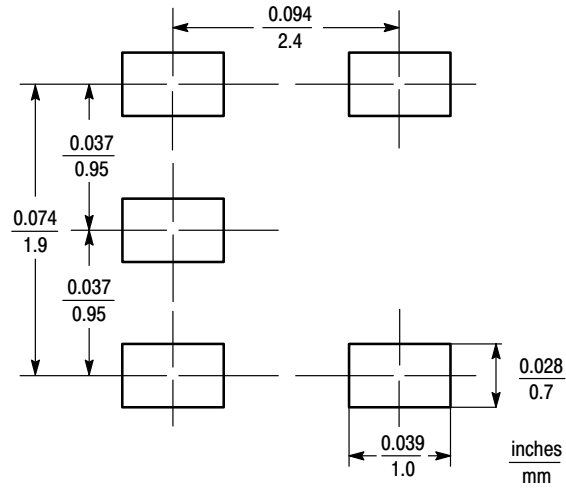
Figure 24. Dual Power Supply Undervoltage Supervision

NCP300, NCP301

MINIMUM RECOMMENDED FOOTPRINT FOR SURFACE MOUNTED APPLICATIONS

Surface mount board layout is a critical portion of the total design. The footprint for the semiconductor packages must be the correct size to insure proper solder connection

interface between the board and the package. With the correct pad geometry, the packages will self align when subjected to a solder reflow process.



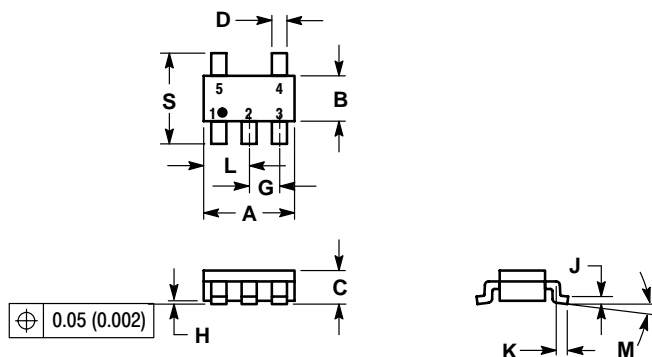
TSOP-5

(Footprint Compatible with SOT23-5)

NCP300, NCP301

PACKAGE DIMENSIONS


TSOP-5
SN SUFFIX
PLASTIC PACKAGE
CASE 483-01
ISSUE A



NOTES:

1. DIMENSIONING AND TOLERANCING PER ANSI Y14.5M, 1982.
2. CONTROLLING DIMENSION: MILLIMETER.
3. MAXIMUM LEAD THICKNESS INCLUDES LEAD FINISH THICKNESS. MINIMUM LEAD THICKNESS IS THE MINIMUM THICKNESS OF BASE MATERIAL.

DIM	MILLIMETERS		INCHES	
	MIN	MAX	MIN	MAX
A	2.90	3.10	0.1142	0.1220
B	1.30	1.70	0.0512	0.0669
C	0.90	1.10	0.0354	0.0433
D	0.25	0.50	0.0098	0.0197
G	0.85	1.00	0.0335	0.0413
H	0.013	0.100	0.0005	0.0040
J	0.10	0.26	0.0040	0.0102
K	0.20	0.60	0.0079	0.0236
L	1.25	1.55	0.0493	0.0610
M	0°	10°	0°	10°
S	2.50	3.00	0.0985	0.1181

ON Semiconductor and  are trademarks of Semiconductor Components Industries, LLC (SCILLC). SCILLC reserves the right to make changes without further notice to any products herein. SCILLC makes no warranty, representation or guarantee regarding the suitability of its products for any particular purpose, nor does SCILLC assume any liability arising out of the application or use of any product or circuit, and specifically disclaims any and all liability, including without limitation special, consequential or incidental damages. "Typical" parameters which may be provided in SCILLC data sheets and/or specifications can and do vary in different applications and actual performance may vary over time. All operating parameters, including "Typicals" must be validated for each customer application by customer's technical experts. SCILLC does not convey any license under its patent rights nor the rights of others. SCILLC products are not designed, intended, or authorized for use as components in systems intended for surgical implant into the body, or other applications intended to support or sustain life, or for any other application in which the failure of the SCILLC product could create a situation where personal injury or death may occur. Should Buyer purchase or use SCILLC products for any such unintended or unauthorized application, Buyer shall indemnify and hold SCILLC and its officers, employees, subsidiaries, affiliates, and distributors harmless against all claims, costs, damages, and expenses, and reasonable attorney fees arising out of, directly or indirectly, any claim of personal injury or death associated with such unintended or unauthorized use, even if such claim alleges that SCILLC was negligent regarding the design or manufacture of the part. SCILLC is an Equal Opportunity/Affirmative Action Employer.

PUBLICATION ORDERING INFORMATION

NORTH AMERICA Literature Fulfillment:

Literature Distribution Center for ON Semiconductor
P.O. Box 5163, Denver, Colorado 80217 USA
Phone: 303-675-2175 or 800-344-3860 Toll Free USA/Canada
Fax: 303-675-2176 or 800-344-3867 Toll Free USA/Canada
Email: ONlit@hibbertco.com
Fax Response Line: 303-675-2167 or 800-344-3810 Toll Free USA/Canada

N. American Technical Support: 800-282-9855 Toll Free USA/Canada

EUROPE: LDC for ON Semiconductor – European Support

German Phone: (+1) 303-308-7140 (Mon-Fri 2:30pm to 7:00pm CET)
Email: ONlit-german@hibbertco.com
French Phone: (+1) 303-308-7141 (Mon-Fri 2:00pm to 7:00pm CET)
Email: ONlit-french@hibbertco.com
English Phone: (+1) 303-308-7142 (Mon-Fri 12:00pm to 5:00pm GMT)
Email: ONlit@hibbertco.com

EUROPEAN TOLL-FREE ACCESS*: 00-800-4422-3781

*Available from Germany, France, Italy, UK

CENTRAL/SOUTH AMERICA:

Spanish Phone: 303-308-7143 (Mon-Fri 8:00am to 5:00pm MST)
Email: ONlit-spanish@hibbertco.com

ASIA/PACIFIC: LDC for ON Semiconductor – Asia Support

Phone: 303-675-2121 (Tue-Fri 9:00am to 1:00pm, Hong Kong Time)
Toll Free from Hong Kong & Singapore:
001-800-4422-3781
Email: ONlit-asia@hibbertco.com

JAPAN: ON Semiconductor, Japan Customer Focus Center

4-32-1 Nishi-Gotanda, Shinagawa-ku, Tokyo, Japan 141-0031
Phone: 81-3-5740-2745
Email: r14525@onsemi.com

ON Semiconductor Website: <http://onsemi.com>

For additional information, please contact your local Sales Representative.