

**2SC5229**

VHF to UHF Wide-Band Low-Noise Amplifier Applications

Features

- Low noise : $NF=1.0\text{dB}$ typ ($f=1\text{GHz}$).
- High gain : $|S_{21e}|^2=10.5\text{dB}$ typ ($f=1\text{GHz}$).
- High cutoff frequency : $f_T=6.5\text{GHz}$ typ.
- Medium power operation : $NF=1.7\text{dB}$ typ ($f=1\text{GHz}$),
($V_{CE}=8\text{V}$, $I_C=40\text{mA}$) : $|S_{21e}|^2=11\text{dB}$ typ
($f=1\text{GHz}$).

Package Dimensions

unit:mm

2038A

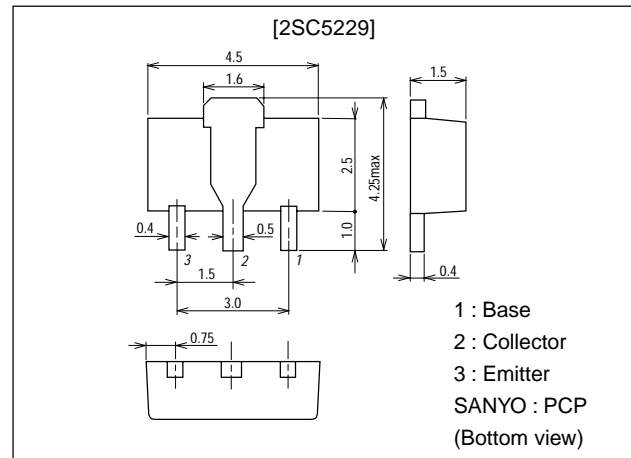

Specifications

Absolute Maximum Ratings at $T_a = 25^\circ\text{C}$

Parameter	Symbol	Conditions	Ratings	Unit
Collector-to-Base Voltage	V_{CBO}		20	V
Collector-to-Emitter Voltage	V_{CEO}		10	V
Emitter-to-Base Voltage	V_{EBO}		2	V
Collector Current	I_C		70	mA
Collector Dissipation	P_C	Mounted on ceramic board (250mm ² ×0.8mm)	700	mW
Junction Temperature	T_J		150	°C
Storage Temperature	T_{stg}		-55 to +150	°C

Electrical Characteristics at $T_a = 25^\circ\text{C}$

Parameter	Symbol	Conditions	Ratings			Unit
			min	typ	max	
Collector Cutoff Current	I_{CBO}	$V_{CB}=10\text{V}$, $I_E=0$			1.0	μA
Emitter Cutoff Current	I_{EBO}	$V_{EB}=1\text{V}$, $I_C=0$			10	μA
DC Current Gain	h_{FE}	$V_{CE}=5\text{V}$, $I_C=20\text{mA}$	60*		270*	
Gain-Bandwidth Product	f_T	$V_{CE}=5\text{V}$, $I_C=20\text{mA}$	4.5	6.5		GHz
Output Capacitance	C_{ob}	$V_{CB}=10\text{V}$, $f=1\text{MHz}$		0.85	1.3	pF
Reverse Transfer Capacitance	C_{re}	$V_{CB}=10\text{V}$, $f=1\text{MHz}$		0.55		pF

* : The 2SC5229 is classified by 20mA h_{FE} as follows :

60	D	120	90	E	180	135	F	270
----	---	-----	----	---	-----	-----	---	-----

Marking : CY

 h_{FE} rank : D, E, F

Continued on next page.

■ Any and all SANYO products described or contained herein do not have specifications that can handle applications that require extremely high levels of reliability, such as life-support systems, aircraft's control systems, or other applications whose failure can be reasonably expected to result in serious physical and/or material damage. Consult with your SANYO representative nearest you before using any SANYO products described or contained herein in such applications.

■ SANYO assumes no responsibility for equipment failures that result from using products at values that exceed, even momentarily, rated values (such as maximum ratings, operating condition ranges, or other parameters) listed in products specifications of any and all SANYO products described or contained herein.

SANYO Electric Co., Ltd. Semiconductor Business Headquarters

TOKYO OFFICE Tokyo Bldg., 1-10, 1 Chome, Ueno, Taito-ku, TOKYO, 110-8534 JAPAN

21599TH (KT)/32795YK (KOTO) TA-0244 No.5045-1/5

2SC5229

Continued from preceding page.

Parameter	Symbol	Conditions	Ratings			Unit
			min	typ	max	
Forward Transfer Gain	$ S_{21e} ^2_1$	$V_{CE}=5V, I_C=20mA, f=1GHz$	8	10.5		dB
	$ S_{21e} ^2_2$	$V_{CE}=8V, I_C=40mA, f=1GHz$		11		dB
Noise Figure	NF1	$V_{CE}=5V, I_C=7mA, f=1GHz$		1.0	1.8	dB
	NF2	$V_{CE}=8V, I_C=40mA, f=1GHz$		1.7		dB

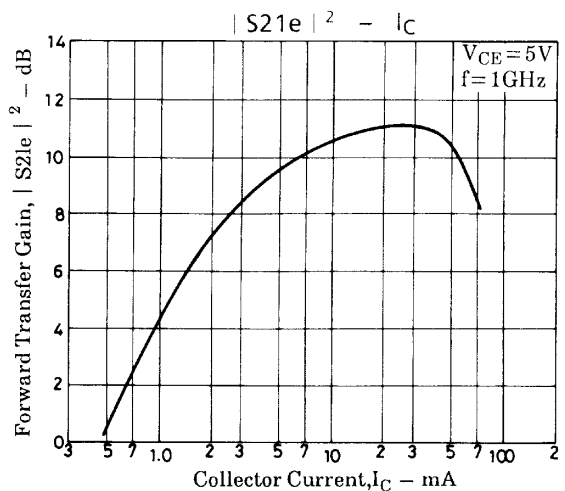
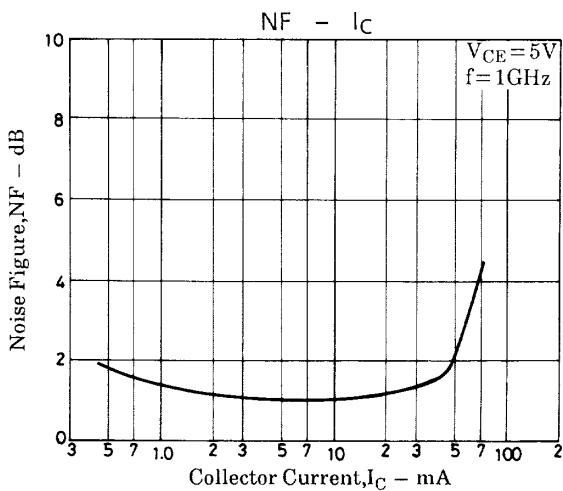
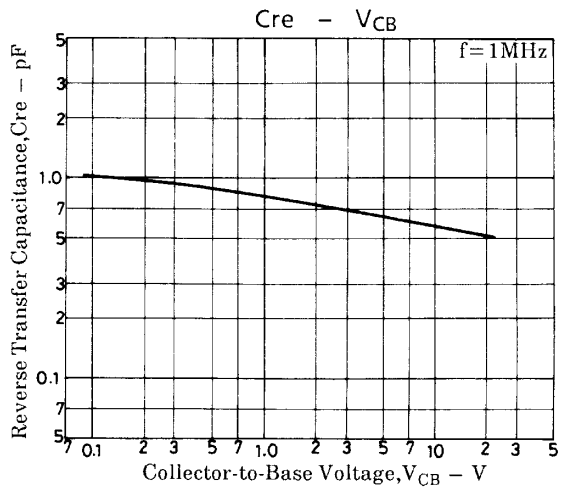
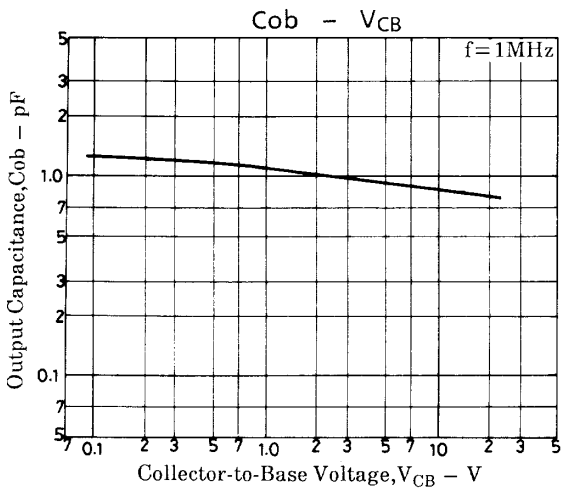
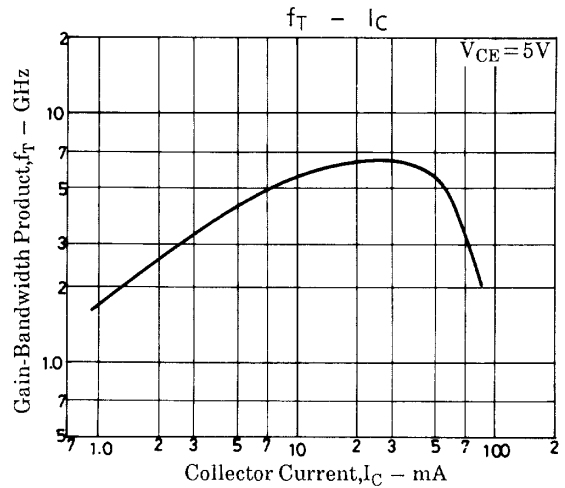
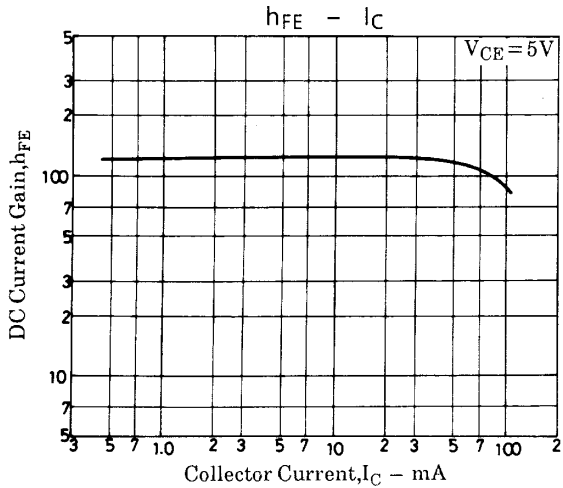

2SC5229

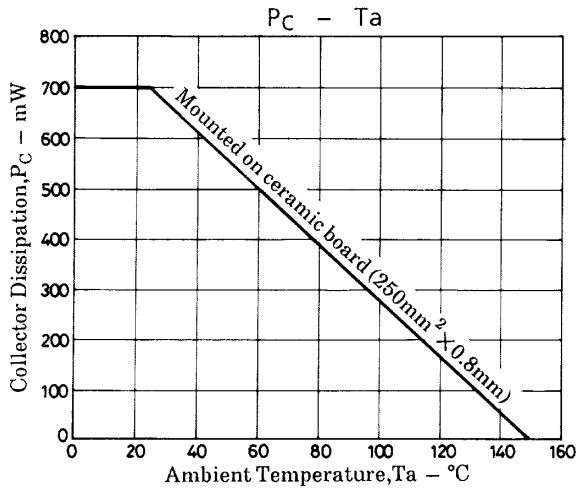

S Parameters

$f = 100\text{MHz}, 200 \text{ to } 2000\text{MHz} (200\text{MHz step})$

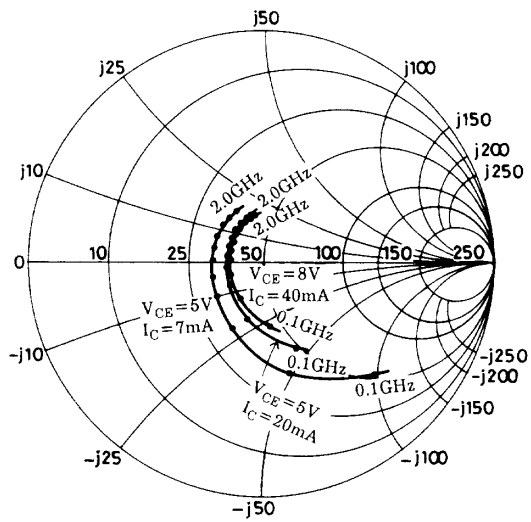

$f = 100\text{MHz}, 200 \text{ to } 2000\text{MHz} (200\text{MHz step})$

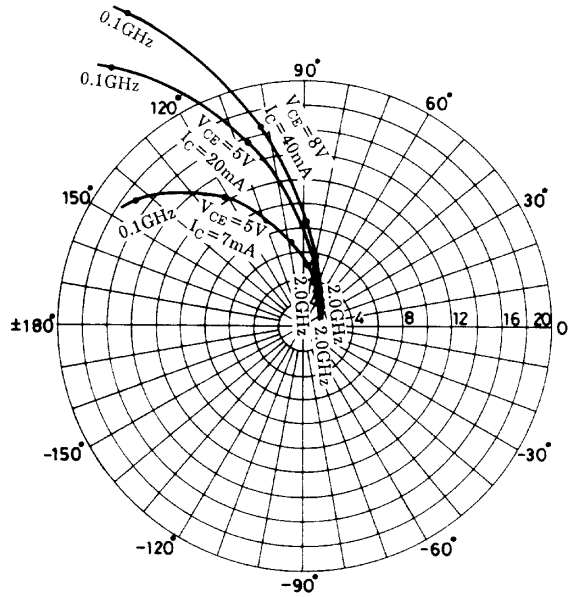

$f = 100\text{MHz}, 200 \text{ to } 2000\text{MHz} (200\text{MHz step})$

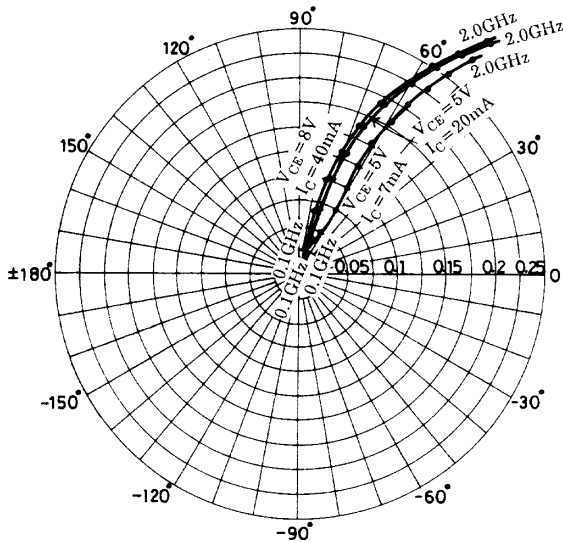

$f = 100\text{MHz}, 200 \text{ to } 2000\text{MHz} (200\text{MHz step})$

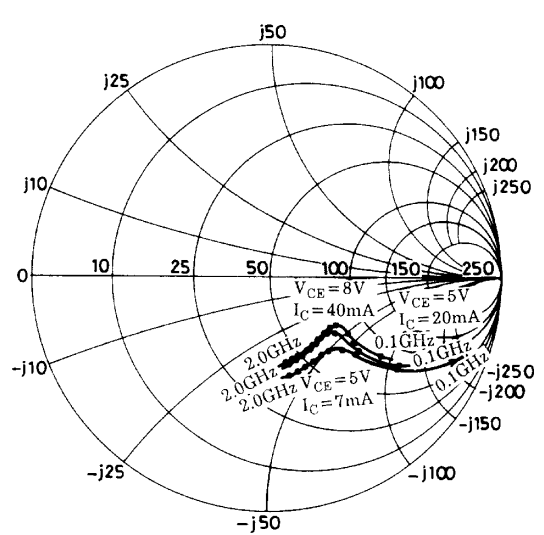

2SC5229

S parameters (Common emitter)

$V_{CE}=5V, I_C=7mA, Z_O=50\Omega$

Freq (MHz)	$ S_{11} $	$\angle S_{11}$	$ S_{21} $	$\angle S_{21}$	$ S_{12} $	$\angle S_{12}$	$ S_{22} $	$\angle S_{22}$
100	0.682	-44.8	16.999	143.0	0.032	69.4	0.848	-24.7
200	0.496	-75.3	12.278	120.6	0.050	61.3	0.663	-36.3
400	0.311	-113.7	7.273	98.2	0.076	60.0	0.492	-43.2
600	0.234	-142.0	5.064	85.4	0.100	61.2	0.435	-46.6
800	0.210	-164.2	3.912	76.2	0.125	61.5	0.413	-50.2
1000	0.201	177.1	3.210	68.5	0.152	61.1	0.408	-54.1
1200	0.204	160.1	2.736	60.8	0.179	59.6	0.411	-58.6
1400	0.213	146.2	2.388	53.9	0.205	57.6	0.416	-63.6
1600	0.226	132.4	2.108	47.3	0.231	55.7	0.423	-68.8
1800	0.232	123.1	1.902	41.7	0.256	53.6	0.431	-73.3
2000	0.242	113.6	1.725	36.5	0.283	51.3	0.438	-77.3

$V_{CE}=5V, I_C=20mA, Z_O=50\Omega$

Freq (MHz)	$ S_{11} $	$\angle S_{11}$	$ S_{21} $	$\angle S_{21}$	$ S_{12} $	$\angle S_{12}$	$ S_{22} $	$\angle S_{22}$
100	0.399	-68.1	26.168	127.2	0.024	69.1	0.663	-35.1
200	0.249	-103.2	15.690	106.6	0.040	69.4	0.468	-41.0
400	0.163	-144.3	8.404	90.2	0.071	71.4	0.362	-42.1
600	0.143	-173.4	5.707	80.5	0.102	70.5	0.337	-45.2
800	0.144	166.1	4.343	73.5	0.133	68.5	0.330	-49.5
1000	0.150	151.3	3.559	66.8	0.165	66.1	0.337	-54.1
1200	0.162	137.3	3.028	60.2	0.195	63.0	0.343	-59.4
1400	0.177	126.4	2.633	53.7	0.225	59.7	0.353	-64.9
1600	0.191	115.0	2.326	48.0	0.252	56.6	0.360	-70.9
1800	0.200	106.9	2.100	42.9	0.279	53.5	0.369	-75.2
2000	0.204	99.8	1.915	37.9	0.307	50.6	0.376	-79.3

$V_{CE}=8V, I_C=40mA, Z_O=50\Omega$

Freq (MHz)	$ S_{11} $	$\angle S_{11}$	$ S_{21} $	$\angle S_{21}$	$ S_{12} $	$\angle S_{12}$	$ S_{22} $	$\angle S_{22}$
100	0.277	-83.1	29.257	119.1	0.021	72.6	0.576	-36.1
200	0.176	-119.8	16.497	101.9	0.037	74.5	0.414	-37.4
400	0.140	-160.6	8.638	87.9	0.069	74.9	0.343	-37.3
600	0.131	172.7	5.847	79.2	0.100	73.2	0.329	-41.1
800	0.136	155.2	4.445	72.3	0.132	70.7	0.328	-46.1
1000	0.144	140.8	3.627	66.0	0.164	67.7	0.335	-51.3
1200	0.159	130.3	3.089	59.7	0.194	64.3	0.344	-57.0
1400	0.173	120.1	2.686	53.5	0.224	50.9	0.354	-52.7
1600	0.188	110.0	2.365	48.0	0.251	57.7	0.362	-68.8
1800	0.188	101.8	2.134	42.7	0.278	54.5	0.372	-73.3
2000	0.206	95.8	1.937	38.1	0.305	51.3	0.380	-77.5

- Specifications of any and all SANYO products described or contained herein stipulate the performance, characteristics, and functions of the described products in the independent state, and are not guarantees of the performance, characteristics, and functions of the described products as mounted in the customer's products or equipment. To verify symptoms and states that cannot be evaluated in an independent device, the customer should always evaluate and test devices mounted in the customer's products or equipment.
- SANYO Electric Co., Ltd. strives to supply high-quality high-reliability products. However, any and all semiconductor products fail with some probability. It is possible that these probabilistic failures could give rise to accidents or events that could endanger human lives, that could give rise to smoke or fire, or that could cause damage to other property. When designing equipment, adopt safety measures so that these kinds of accidents or events cannot occur. Such measures include but are not limited to protective circuits and error prevention circuits for safe design, redundant design, and structural design.
- In the event that any or all SANYO products(including technical data, services) described or contained herein are controlled under any of applicable local export control laws and regulations, such products must not be exported without obtaining the export license from the authorities concerned in accordance with the above law.
- No part of this publication may be reproduced or transmitted in any form or by any means, electronic or mechanical, including photocopying and recording, or any information storage or retrieval system, or otherwise, without the prior written permission of SANYO Electric Co., Ltd.
- Any and all information described or contained herein are subject to change without notice due to product/technology improvement, etc. When designing equipment, refer to the "Delivery Specification" for the SANYO product that you intend to use.
- Information (including circuit diagrams and circuit parameters) herein is for example only ; it is not guaranteed for volume production. SANYO believes information herein is accurate and reliable, but no guarantees are made or implied regarding its use or any infringements of intellectual property rights or other rights of third parties.

This catalog provides information as of February, 1999. Specifications and information herein are subject to change without notice.