

LZ0P3620/3621/ 3622★/3625★

1/4-type Built-in Lens Color CCD Area Sensors with 320 k Pixels

★Under development

DESCRIPTION

The LZ0P3620/21/22★/25★ are 1/4-type (4.5 mm) 320 000-pixel built-in lens color CCD (charge-coupled device) area sensors. With their small lens and WLCC-type flat package, it is possible to make ultra small color camera easily.

FEATURES

- Number of effective pixels : 512 (H) x 582 (V)
- Number of optical black pixels
 - Horizontal : 2 front and 28 rear
- Pixel pitch : 7.2 μm (H) x 4.7 μm (V)
- Mg, G, Cy, and Ye complementary color filters
- Low fixed-pattern noise and lag
- Blooming suppression structure
- Built-in output amplifier
- Built-in overflow drain voltage circuit and reset gate voltage circuit
- Horizontal shift register clock and reset gate clock voltage : 3.3 V (TYP.)
- Variable electronic shutter (1/50 to 1/10 000 s)
- Compatible with PAL standard
- Built-in optical low-pass-filter
- Integrated lens :
 - Horizontal viewing angle
 - LZ0P3620 : 52°
 - LZ0P3621 : 50°
 - ★LZ0P3622 : 62°
 - ★LZ0P3625 : 115°

- Package
 - 14-pin half-pitch WLCC* type
 - Base section size : 12 mm (H) x 11 mm (V)
 - Outline dimensions (MAX.) : 18 mm (H) x 11 mm (V)
- Package height
 - Approx. 10 mm (single lens) : LZ0P3620
 - Approx. 13 mm (two pcs. of lenses) : LZ0P3621/22★/25★

* Window Leadless Chip Carrier

PIN CONNECTIONS

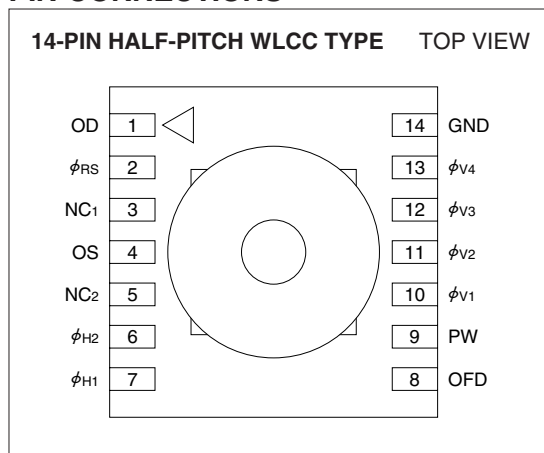

COMPARISON TABLE

	LZ0P3620	LZ0P3621	★LZ0P3622	★LZ0P3625
Horizontal viewing angle	52°	50°	62°	115°
Number of integrated lenses	Single	Two pcs.		
Package height	Approx. 10 mm	Approx. 13 mm		
Characteristics	Refer to each following specification.			
Lens specification				

PIN DESCRIPTION

SYMBOL	PIN NAME
OD	Output transistor drain
OS	Output signals
ϕ RS	Reset transistor clock
ϕ V1, ϕ V2, ϕ V3, ϕ V4	Vertical shift register clock
ϕ H1, ϕ H2	Horizontal shift register clock
OFD	Overflow drain
PW	P-well
GND	Ground
NC1, NC2	No connection

ABSOLUTE MAXIMUM RATINGS

(TA = +25 °C)

PARAMETER	SYMBOL	RATING	UNIT	NOTE
Output transistor drain voltage	VOD	0 to +18	V	
Overflow drain voltage	VOFD	Internal output	V	1
Reset gate clock voltage	V ϕ RS	Internal output	V	2
Vertical shift register clock voltage	V ϕ V	-10.5 to +17.5	V	
Horizontal shift register clock voltage	V ϕ H	-0.3 to +12	V	
Voltage difference between P-well and vertical clock	VPW-V ϕ V	-28 to 0	V	
Voltage difference between vertical clocks	V ϕ V-V ϕ V	0 to +15	V	3
Storage temperature	TSTG	-20 to +70	°C	
Ambient operating temperature	TOPR	-10 to +60	°C	

NOTES :

1. Do not connect to DC voltage directly. When OFD is connected to GND, connect VOD to GND. Overflow drain clock is applied below 26 Vp-p.
2. Do not connect to DC voltage directly. When ϕ RS is connected to GND, connect VOD to GND. Reset gate clock is applied below 8 Vp-p.
3. When clock width is below 10 μ s, and clock duty factor is below 0.1%, voltage difference between vertical clocks will be below 27 V.

RECOMMENDED OPERATING CONDITIONS

PARAMETER		SYMBOL	MIN.	TYP.	MAX.	UNIT	NOTE
Ambient operating temperature		TOPR		25.0		°C	
Output transistor drain voltage		VOD	14.55	15.0	15.45	V	
Overflow drain clock	p-p level	V ϕ OFD	21.5		23.5	V	1
Ground		GND		0.0		V	
P-well voltage		VPW	-9.0		V ϕ VL	V	2
Vertical shift register clock	LOW level	V ϕ V1L, V ϕ V2L V ϕ V3L, V ϕ V4L	-8.5	-8.0	-7.5	V	
	INTERMEDIATE level	V ϕ V1I, V ϕ V2I V ϕ V3I, V ϕ V4I		0.0		V	
	HIGH level	V ϕ V1H, V ϕ V3H	14.55	15.0	15.45	V	
Horizontal shift register clock	LOW level	V ϕ H1L, V ϕ H2L	-0.05	0.0	0.05	V	
	HIGH level	V ϕ H1H, V ϕ H2H	3.0	3.3	5.25	V	
Reset gate clock	p-p level	V ϕ RS	3.0	3.3	5.25	V	1
Vertical shift register clock frequency		f ϕ V1, f ϕ V2 f ϕ V3, f ϕ V4		15.63		kHz	
Horizontal shift register clock frequency		f ϕ H1, f ϕ H2		9.66		MHz	
Reset gate clock frequency		f ϕ RS		9.66		MHz	

NOTES :

- Connect NC1 and NC2 to GND directly or through a capacitor larger than 0.047 μ F.
1. Use the circuit parameter indicated in "**SYSTEM CONFIGURATION EXAMPLE**", and do not connect to DC voltage directly.
 2. VPW is set below V ϕ VL that is low level of vertical shift register clock, or is used with the same power supply that is connected to VL of V driver IC.
- * To apply power, first connect GND and then turn on VOD. After turning on VOD, turn on PW first and then turn on other powers and pulses. Do not connect the device to or disconnect it from the plug socket while power is being applied.

CHARACTERISTICS FOR LZ0P3620 (Drive method : Field accumulation)

(TA : +25 °C, Operating conditions : The typical values specified in "RECOMMENDED OPERATING CONDITIONS".
Color temperature of light source : 3 200 K)

PARAMETER	SYMBOL	MIN.	TYP.	MAX.	UNIT	NOTE
Standard output voltage	V _O		150		mV	1
Saturation output voltage	V _{SAT}	700			mV	2
Sensitivity	R	350	450		mV	3
Resolution (at center)		250	300		TV line	4
Resolution (at corner)		150	200		TV line	5
Shading		50	65		%	6
Difference of center position				±10	%	7
Output transistor drain current	I _{OD}		4.0	8.0	mA	

NOTES :

- The average output voltage in the central area (H/10, V/10) under uniform illumination.
The standard exposure conditions are defined as when V_O is 150 mV.
- The average output voltage in the central area (H/10, V/10) under 10 times exposure of the standard exposure conditions.
- The average output voltage in the central area (H/10, V/10) when a 1 000 lux light source with a white board of 90% reflector is imaged.
- The resolution in the central area (H/10, V/10) at which the image of the TV resolution chart (ex. EIAJ test chart) can be distinguished on the B/W video monitor.
- The resolution in the peripheral area (image height : Y = 0.8) under the conditions mentioned above.
- Defined by the following formula at the brightness of standard output voltage : (V_{co}/V_{ce}) × 100 [%]
V_{co} : Output voltage at edge of the image (at video output).
V_{ce} : Output voltage at center of the image (at video output).
- The difference between the center position of image and that of the monitor. This is the ratio for the horizontal underscanning monitor size which includes the decentering eccentricity when turning the lens head one time.

LENS SPECIFICATION FOR LZ0P3620

PARAMETER	SPECIFICATION	NOTE
Construction	Single (non-spherical, plastic)	
Focal length	4.0 mm [TYP. : reference]	
F No.	2.8±5%	
Viewing angle	H : 52°, V : 40°, Diagonal : 65° [TYP. : reference]	
TV distortion	≤ -3.2%	1
Focus adjustment range	∞ to 10 cm	2
Torque of focusing	0.00005 to 0.001 N·m	3

NOTES :

- TV distortion is defined by the formula, (Δy/y) × 100 [%] at capturing rectangular pattern sized horizontal by vertical as 4 by 3.
"y" is defined as the vertical height of the center of the horizontal line.
Δy is defined as the difference between the vertical height of the center of the horizontal line and an edge of it.
 - The best focus point of an object can be obtained by turning the lens head within this range.
 - Torques which are necessary for turning the lens.
- * Be careful not to remove the lens head by turning it counterclockwise too much when adjusting macro.

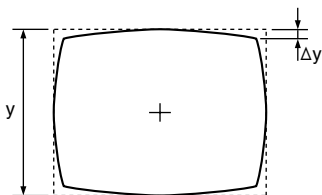

CHARACTERISTICS FOR LZ0P3621 (Drive method : Field accumulation)

(TA : +25 °C, Operating conditions : The typical values specified in "RECOMMENDED OPERATING CONDITIONS".

Color temperature of light source : 3 200 K)

PARAMETER	SYMBOL	MIN.	TYP.	MAX.	UNIT	NOTE
Standard output voltage	V _O		150		mV	1
Saturation output voltage	V _{SAT}	700			mV	2
Sensitivity	R	350	450		mV	3
Resolution (at center)		250	300		TV line	4
Resolution (at corner)		150	200		TV line	5
Shading		40	60		%	6
Difference of center position				±10	%	7
Output transistor drain current	I _{OD}		4.0	8.0	mA	

NOTES :

- The average output voltage in the central area (H/10, V/10) under uniform illumination.
The standard exposure conditions are defined as when V_O is 150 mV.
- The average output voltage in the central area (H/10, V/10) under 10 times exposure of the standard exposure conditions.
- The average output voltage in the central area (H/10, V/10) when a 1 000 lux light source with a white board of 90% reflector is imaged.
- The resolution in the central area (H/10, V/10) at which the image of the TV resolution chart (ex. EIAJ test chart) can be distinguished on the B/W video monitor.
- The resolution in the peripheral area (image height : Y = 0.8) under the conditions mentioned above.
- Defined by the following formula at the brightness of standard output voltage : (V_{co}/V_{ce}) x 100 [%]
V_{co} : Output voltage at edge of the image (at video output).
V_{ce} : Output voltage at center of the image (at video output).
- The difference between the center position of image and that of the monitor. This is the ratio for the horizontal underscanning monitor size which includes the decentering eccentricity when turning the lens head one time.

LENS SPECIFICATION FOR LZ0P3621

PARAMETER	SPECIFICATION	NOTE
Construction	2 pcs. (non-spherical, plastic)	
Focal length	3.9 mm [TYP. : reference]	
F No.	2.8±5%	
Viewing angle	H : 50°, V : 38°, Diagonal : 60° [TYP. : reference]	
TV distortion	≤ -1.0%	1
Focus adjustment range	∞ to 10 cm	2
Torque of focusing	0.00005 to 0.001 N·m	3

NOTES :

- TV distortion is defined by the formula, (Δy/y) x 100 [%] at capturing rectangular pattern sized horizontal by vertical as 4 by 3.
"y" is defined as the vertical height of the center of the horizontal line.
Δy is defined as the difference between the vertical height of the center of the horizontal line and an edge of it.
 - The best focus point of an object can be obtained by turning the lens head within this range.
 - Torques which are necessary for turning the lens.
- * Be careful not to remove the lens head by turning it counterclockwise too much when adjusting macro.

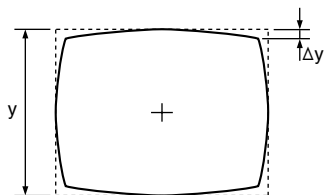

★Under development

CHARACTERISTICS FOR LZ0P3622★ (Drive method : Field accumulation)

(TA : +25 °C, Operating conditions : The typical values specified in "RECOMMENDED OPERATING CONDITIONS".

Color temperature of light source : 3 200 K)

PARAMETER	SYMBOL	MIN.	TYP.	MAX.	UNIT	NOTE
Standard output voltage	V _O		150		mV	1
Saturation output voltage	V _{SAT}	700			mV	2
Sensitivity	R	350	450		mV	3
Resolution (at center)		250	300		TV line	4
Resolution (at corner)		150	200		TV line	5
Shading			50		%	6
Difference of center position				±10	%	7
Output transistor drain current	I _{OD}		4.0	8.0	mA	

NOTES :

- The average output voltage in the central area (H/10, V/10) under uniform illumination.
The standard exposure conditions are defined as when V_O is 150 mV.
- The average output voltage in the central area (H/10, V/10) under 10 times exposure of the standard exposure conditions.
- The average output voltage in the central area (H/10, V/10) when a 1 000 lux light source with a white board of 90% reflector is imaged.
- The resolution in the central area (H/10, V/10) at which the image of the TV resolution chart (ex. EIAJ test chart) can be distinguished on the B/W video monitor.
- The resolution in the peripheral area (image height : Y = 0.8) under the conditions mentioned above.
- Defined by the following formula at the brightness of standard output voltage : (V_{co}/V_{ce}) x 100 [%]
V_{co} : Output voltage at edge of the image (at video output).
V_{ce} : Output voltage at center of the image (at video output).
- The difference between the center position of image and that of the monitor. This is the ratio for the horizontal underscanning monitor size which includes the decentering eccentricity when turning the lens head one time.

LENS SPECIFICATION FOR LZ0P3622★

PARAMETER	SPECIFICATION	NOTE
Construction	2 pcs. (non-spherical, plastic)	
Focal length	3.0 mm [TYP. : reference]	
F No.	2.8±5%	
Viewing angle	H : 62°, V : 49°, Diagonal : 74° [TYP. : reference]	
TV distortion	≤ -1.0%	1
Focus adjustment range	∞ to 10 cm	2
Torque of focusing	0.00005 to 0.001 N·m	3

NOTES :

- TV distortion is defined by the formula, (Δy/y) x 100 [%] at capturing rectangular pattern sized horizontal by vertical as 4 by 3.
"y" is defined as the vertical height of the center of the horizontal line.
Δy is defined as the difference between the vertical height of the center of the horizontal line and an edge of it.
 - The best focus point of an object can be obtained by turning the lens head within this range.
 - Torques which are necessary for turning the lens.
- * Be careful not to remove the lens head by turning it counterclockwise too much when adjusting macro.

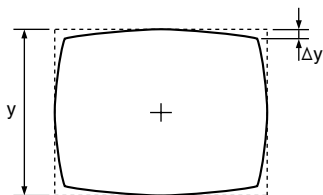

★Under development

CHARACTERISTICS FOR LZ0P3625★ (Drive method : Field accumulation)

(TA : +25 °C, Operating conditions : The typical values specified in "RECOMMENDED OPERATING CONDITIONS".

Color temperature of light source : 3 200 K)

PARAMETER	SYMBOL	MIN.	TYP.	MAX.	UNIT	NOTE
Standard output voltage	V _O		150		mV	1
Saturation output voltage	V _{SAT}	700			mV	2
Sensitivity	R	350	450		mV	3
Resolution (at center)			300		TV line	4
Resolution (at corner)			200		TV line	5
Shading			45		%	6
Difference of center position				±10	%	7
Output transistor drain current	I _{OD}		4.0	8.0	mA	

NOTES :

- The average output voltage in the central area (H/10, V/10) under uniform illumination.
The standard exposure conditions are defined as when V_O is 150 mV.
- The average output voltage in the central area (H/10, V/10) under 10 times exposure of the standard exposure conditions.
- The average output voltage in the central area (H/10, V/10) when a 1 000 lux light source with a white board of 90% reflector is imaged.
- The resolution in the central area (H/10, V/10) at which the image of the TV resolution chart (ex. EIAJ test chart) can be distinguished on the B/W video monitor.
- The resolution in the peripheral area (image height : Y = 0.8) under the conditions mentioned above.
- Defined by the following formula at the brightness of standard output voltage : (V_{co}/V_{ce}) x 100 [%]
V_{co} : Output voltage at edge of the image (at video output).
V_{ce} : Output voltage at center of the image (at video output).
- The difference between the center position of image and that of the monitor. This is the ratio for the horizontal underscanning monitor size which includes the decentering eccentricity when turning the lens head one time.

LENS SPECIFICATION FOR LZ0P3625★

PARAMETER	SPECIFICATION	NOTE
Construction	2 pcs. (non-spherical, plastic)	
Focal length	1.53 mm [TYP. : reference]	
F No.	2.8±5%	
Viewing angle	H : 115°, V : 89°, Diagonal : 138° [TYP. : reference]	
TV distortion	≤ -14%	1
Focus adjustment range	∞ to 10 cm	2
Torque of focusing	0.00005 to 0.001 N·m	3

NOTES :

- TV distortion is defined by the formula, (Δy/y) x 100 [%] at capturing rectangular pattern sized horizontal by vertical as 4 by 3.
"y" is defined as the vertical height of the center of the horizontal line.
Δy is defined as the difference between the vertical height of the center of the horizontal line and an edge of it.
 - The best focus point of an object can be obtained by turning the lens head within this range.
 - Torques which are necessary for turning the lens.
- * Be careful not to remove the lens head by turning it counterclockwise too much when adjusting macro.

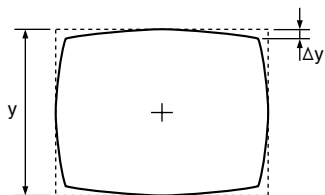

PIXEL STRUCTURE



COLOR FILTER ARRAY

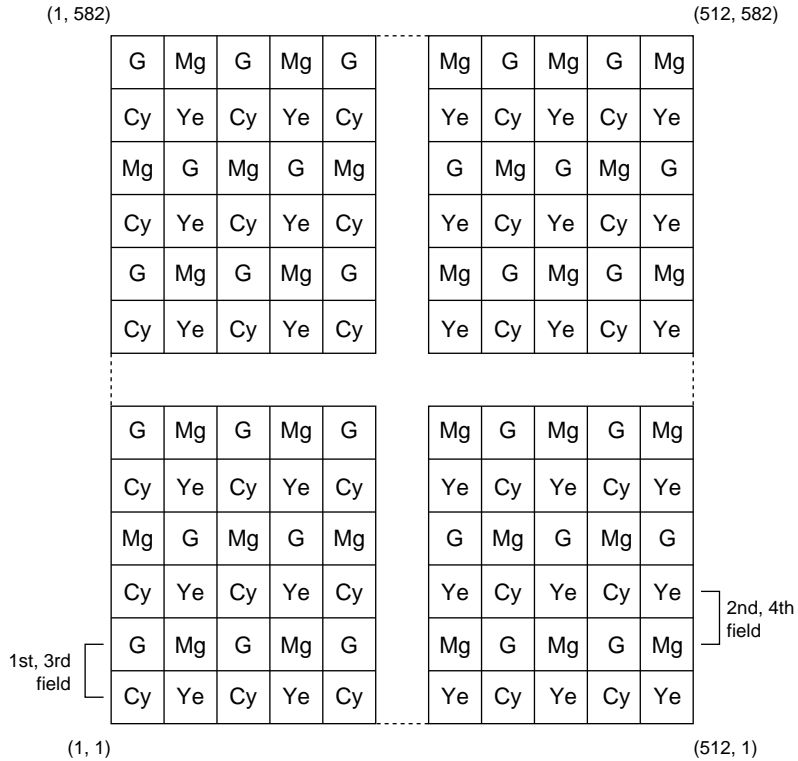

TIMING CHART

(1st, 3rd FIELD)

VERTICAL TRANSFER TIMING

Shutter speed

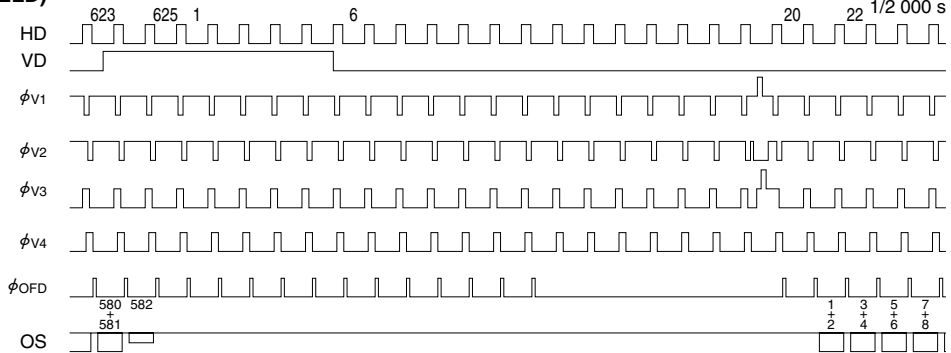

(2nd, 4th FIELD)

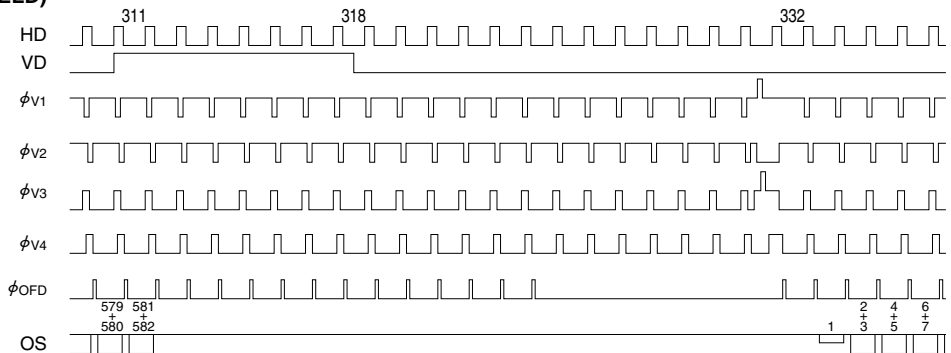

HORIZONTAL TRANSFER TIMING

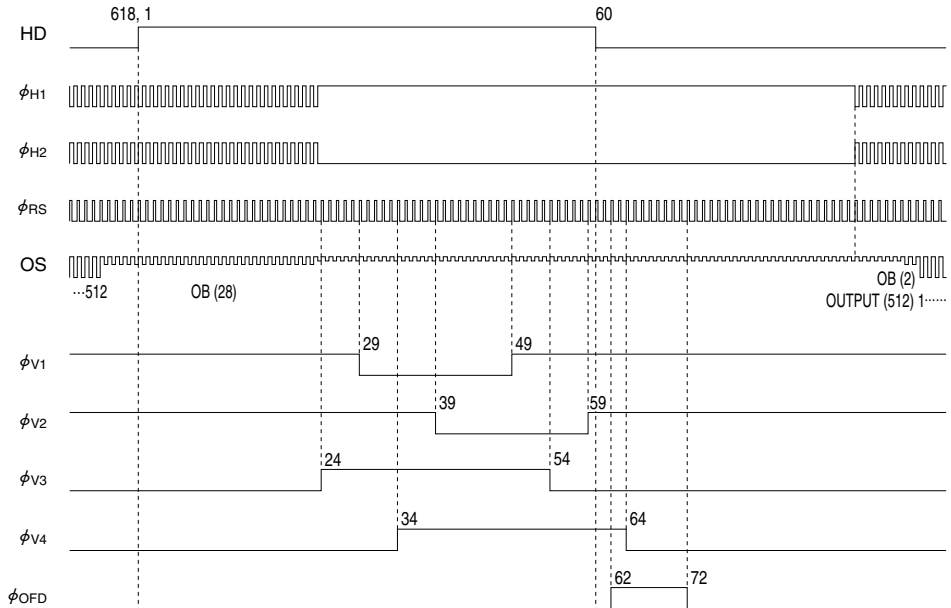

(1st, 3rd FIELD)

READOUT TIMING

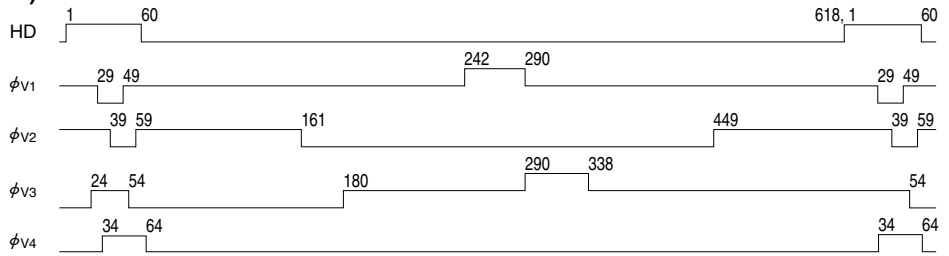

(2nd, 4th FIELD)

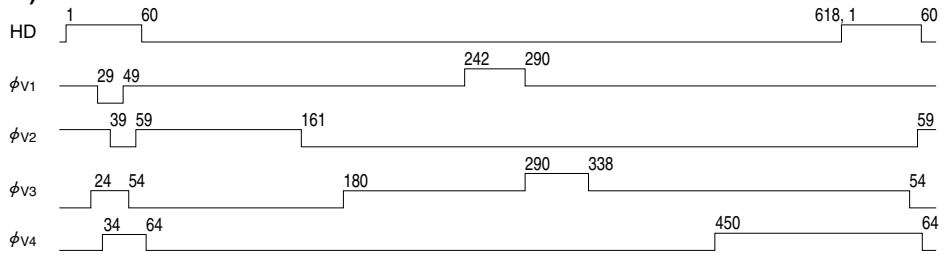

SYSTEM CONFIGURATION EXAMPLE

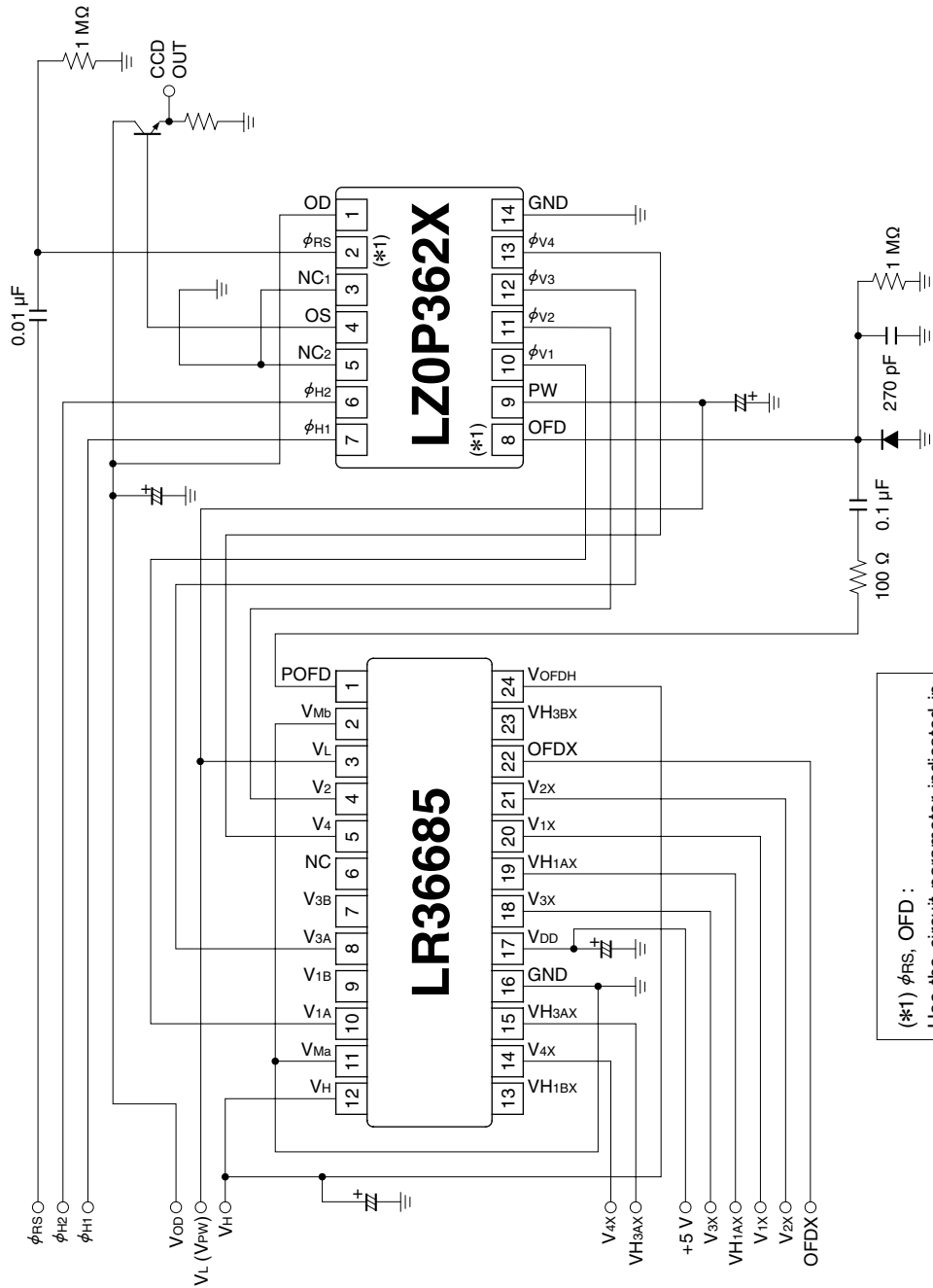

(*1) ϕ_{RS} , OFD :
Use the circuit parameter indicated in this circuit example, and do not connect to DC voltage directly.

PACKAGES

(Unit : mm)

14 WLCC TYPE

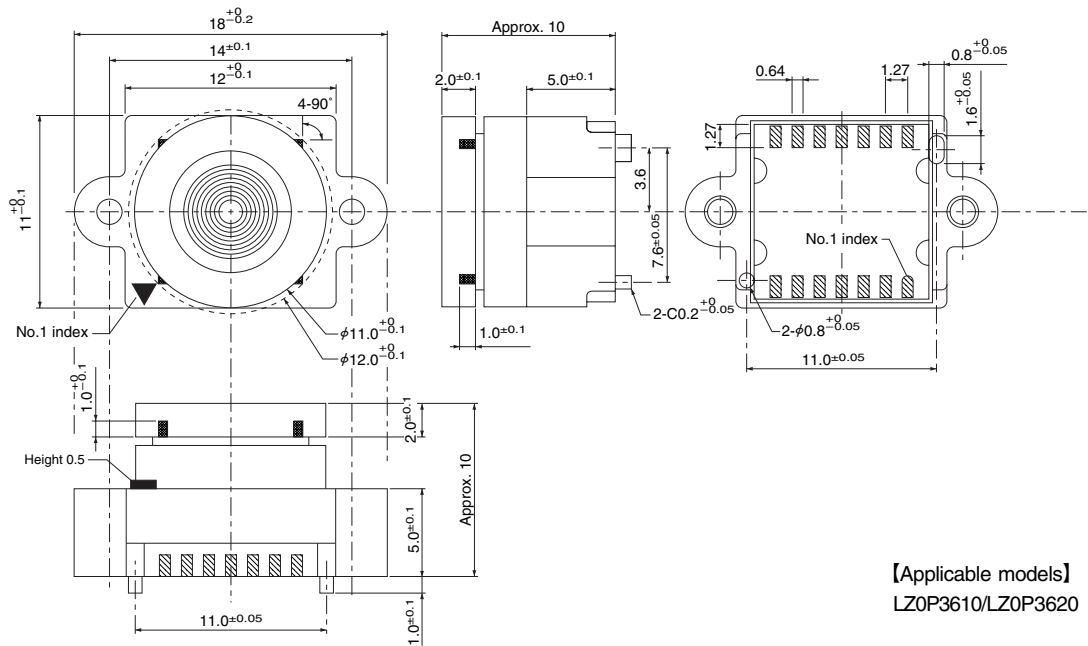

14 WLCC TYPE

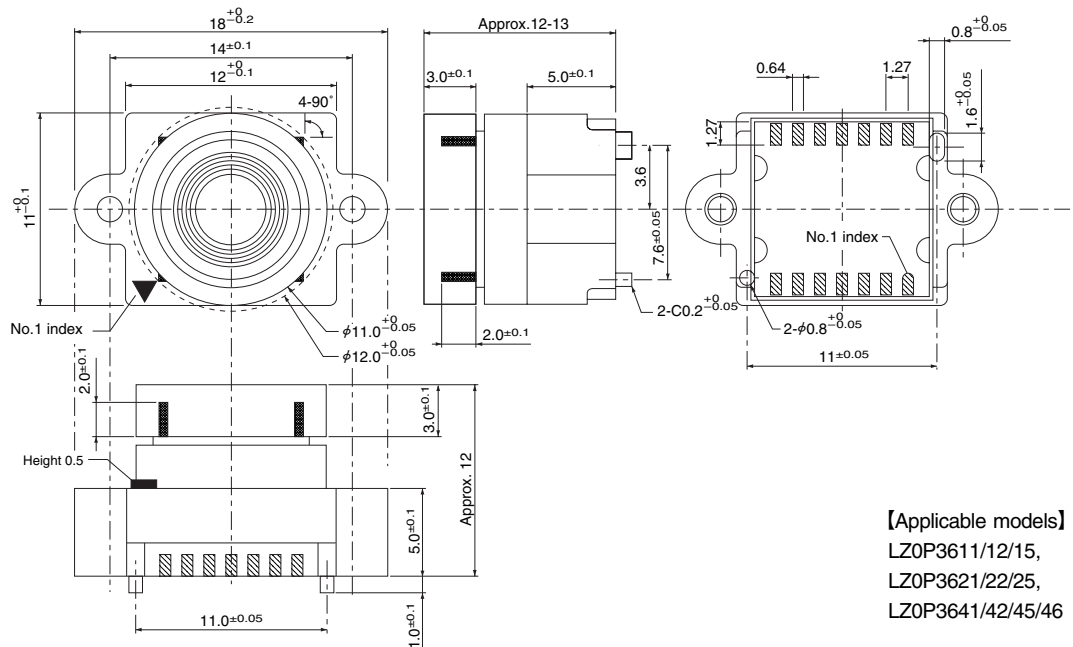

PRECAUTIONS FOR BUILT-IN LENS CCD AREA SENSORS

1. Package Breakage

In order to prevent the package, the lens holder, and the lens from being broken, follow the instructions below :

- 1) The CCD is a precise optical component and the package-base material is ceramic.

Therefore,

- Take care not to drop the device when mounting, handling, or transporting.
 - Avoid giving a shock to the package.
Especially when leads are fixed to the socket or the circuit board, a small shock could break the package more easily than when the package isn't fixed.
- 2) When adjusting the focus, screw the lens holder to the circuit board before soldering the leads. At that time, make sure to use a circuit board with plenty of strength, and to avoid the package and the lens holder from being broken, the following screw and clamp torque are recommended.
 - Recommended mounting screw :
 $\phi 1.7$ tapping screw (B-tight type),
Length, L = the thickness of the circuit board + 5 mm
 - Recommended clamp torque : $0.012 \text{ N} \cdot \text{m}$
[however, when the thickness of the circuit board is thinner than $t = 2.0 \text{ mm}$]
 - 3) If any damage or breakage occurs on the surface of the lens, its characteristics could deteriorate.
Therefore,
 - Do not hit the lens.
 - Do not give a shock large enough to cause distortion.
 - Do not scrub or scratch the surface of the lens.
 - Even a soft cloth or applicator, if dry, could cause dust to scratch the lens.

2. Electrostatic Damage

As compared with general MOS-LSI, CCD has lower ESD. Therefore, take the following anti-static measures when handling the CCD :

- 1) Always discharge static electricity by grounding the human body and the instrument to be used.
To ground the human body, provide resistance of about $1 \text{ M}\Omega$ between the human body and the ground to be on the safe side.
- 2) When directly handling the device with the fingers, hold the lens holder and do not touch the lead.
- 3) To avoid generating static electricity,
 - a. do not scrub the device with cloth or plastic.
 - b. do not attach any tape or labels.
 - c. do not clean the device with dust-cleaning tape.
- 4) When storing or transporting the device, put it in a container of conductive material.

3. Dust and Contamination

Dust or contamination on the surface of the lens and the inside of the lens holder could deteriorate the output characteristics or cause a scar. In order to minimize dust or contamination on the device, take the following precautions :

- 1) Do not remove the lens from the body.
Especially when adjusting macro, be careful not to remove the lens by turning it counter-clockwise too much.
- 2) Do not touch the surface of the lens with the fingers. If dust or contamination gets on the surface of the lens, the following cleaning method is recommended :
 - Handle the built-in lens CCD in a clean environment such as a cleaned booth. (The cleanliness level should be, if possible, class 1 000 at least.)

- Dust from static electricity should be blown off with an ionized air blower. For anti-electrostatic measures, however, ground all the leads on the device before blowing off the dust.
- The contamination on the surface of the lens should be wiped off with a clean applicator soaked in isopropyl alcohol. Wipe slowly and gently in one direction only.
- Frequently replace the applicator and do not use the same applicator to clean more than one device.

- Make sure there is no dust or contamination on the lens and screw it on the lens holder.

4. Other

1) Soldering should be manually performed under the following conditions :

- Use ESD-measured soldering iron
- The conditions of the soldering time in which the soldering iron touches the package, differs by the shape and the temperature of the iron end. Refer to the table below and take great care in soldering.

THE SHAPE OF THE IRON END	THE TEMPERATURE OF THE IRON END	SOLDERING TIME
	Below 350 °C	Time touching the package should be less than 40 seconds
	Below 300 °C	Time touching the package should be less than 25 seconds
	Below 275 °C	Time touching the package should be less than 35 seconds

- In case where the soldering may exceed the time mentioned above, resume the work after the device returns to normal temperature.
- Do not put too much force onto the lens and the lens holder while soldering.
- Be careful not to let the soldering iron touch the lens holder.
- Soldering can be quickly/neatly done by laying the soldering iron so it lightly touches the border between the package and the circuit board and sliding it in sideways.

- 2) There is no guarantee of the performance of the device which has been removed or resoldered after being soldered once under the conditions mentioned above.
 - In case there seems to be an inferior device, consult with our sales office before removing it.
- 3) Avoid using or storing the CCD at high temperature or high humidity as it is a precise optical component. Do not give a mechanical shock to the CCD.
- 4) Do not expose the device to strong light. For the color device, long exposure to strong light will fade the color of the color filters.