

# TC9146AP, TC9147BP

T-77-05-07

DTS-8

LSI FOR STATIC FM/MW/LW 3 BANDS  
DIGITAL TUNING SYSTEM

The TC9146AP/TC9147BP is the system LSI with PLL and control circuits integrated in single chip that has been developed for application to PLL synthesizer type digital tuning system.

The receiving frequency bands in the European region are 3 bands of FM/MW/LW.

The static type input/output unit has been employed to improve performance and simplify design.

This LSI is available in the following two types according to difference in the frequency display system :

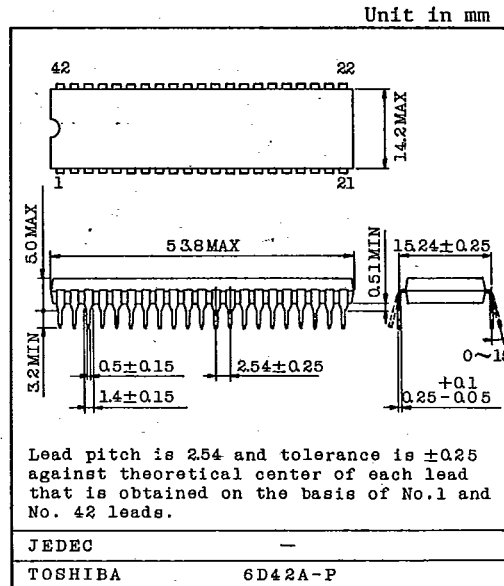

- TC9146AP : Analog display in 16 dots.
- TC9147BP : Digital display by a 7-segment display with TD6301AP added.
- PLL and control circuits have been integrated in single chip.
- To accommodate use in Japan, U.S.A. and European regions, the version for European region is in 3 bands structure of FM/MW/LW, and the version for domestic use in Japan is in 2 bands structure of FM/AM (MW).
- The operating keys, frequency displays and various operating displays are all of static type.
- With preset memories for 16 channels built in, various applications are possible. In addition, the last frequency memory and last channel memory are provided for each frequency band. On TC9146AP, the preset memories for 6 channels are provided for FM/AM (MW+LW).
- The auto stop circuit has been further completed with due consideration for stop during the auto search operation.
- The display LED drivers have been built in and almost no external part is required.
- The swallow counter is formed in combination with prescaler TD6104P at FM to provide reference frequency 25kHz for improving the performance.

**TOSHIBA**

# TC9146AP, TC9147BP

T-77-05-07

MAXIMUM RATINGS (Ta=25°C)

CHARACTERISTIC	SYMBOL	RATINGS	UNIT
Supply Voltage	V <sub>DD</sub>	0 ~ 6	V
Input Voltage	V <sub>IN</sub>	-0.3 ~ V <sub>DD</sub> +0.3	V
Output Voltage	V <sub>OUT</sub>	-0.3 ~ V <sub>DD</sub> +0.3	V
Output Current (Note)	I <sub>OUT</sub>	30	mA
Power Dissipation	P <sub>D</sub>	800	mW
Operating Temperature	T <sub>opr</sub>	-30 ~ 75	°C
Storage Temperature	T <sub>stg</sub>	-55 ~ 125	°C

(Note) Bipolar transistor output current.

PIN CONNECTION

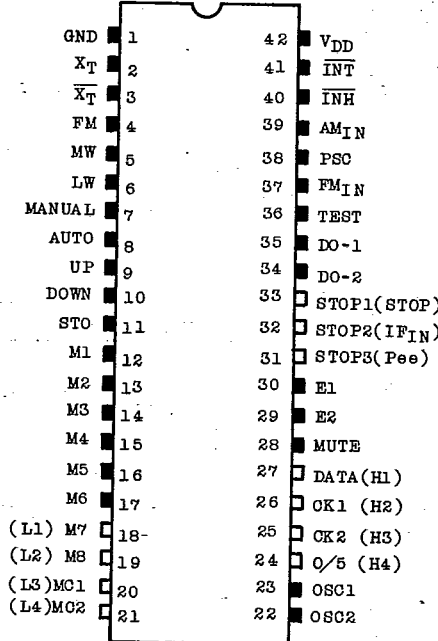

■ TERMINAL IS COMMON TO  
TC9146AP, TC9147BP

□ TERMINAL ( ) DENOTES  
TERMINAL NAME OF  
TC9146AP

# TC9146AP, TC9147BP

T-77-05-07

BLOCK DIAGRAM

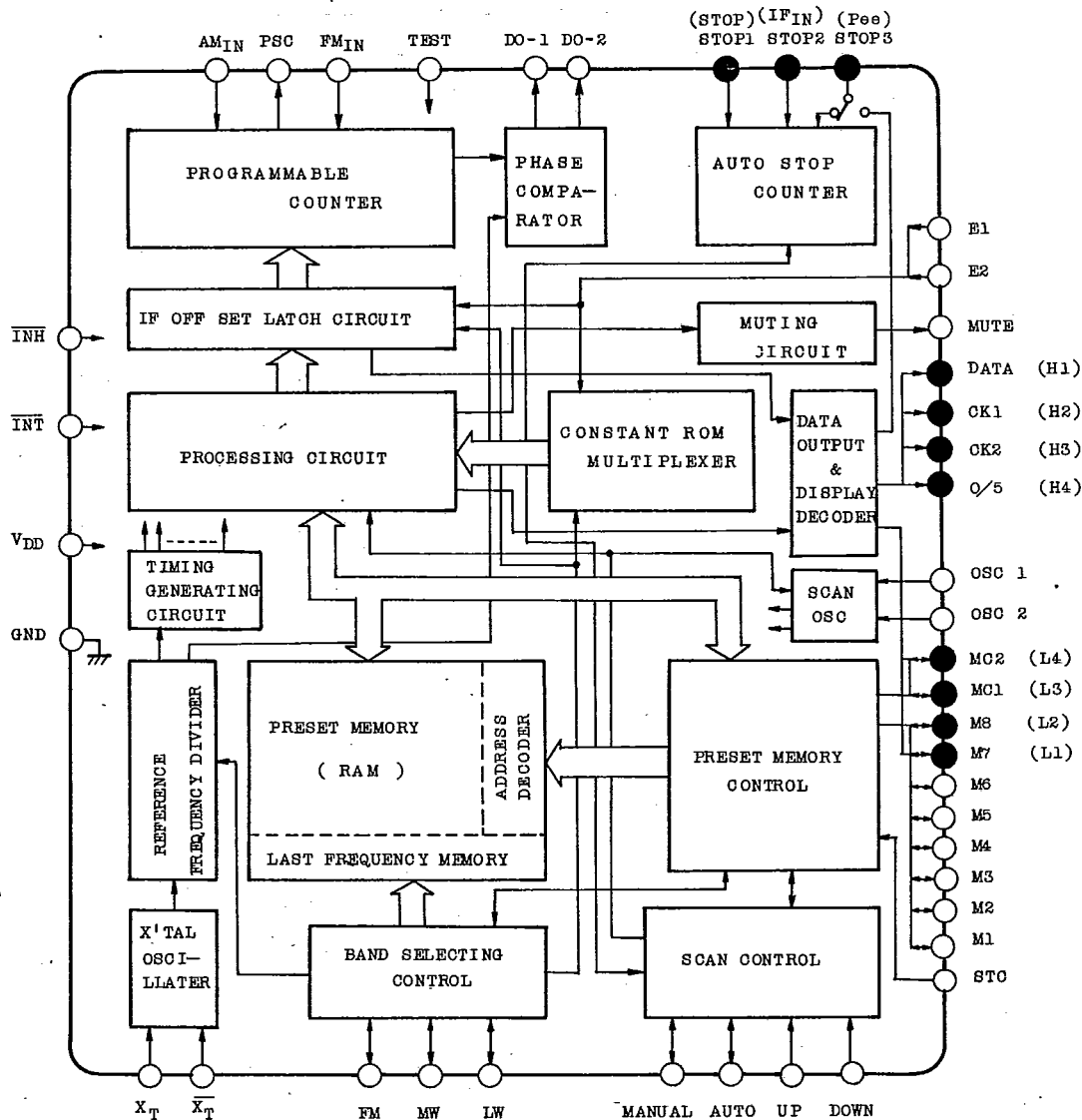

● ( ) of ● denotes terminal name of TC9146AP  
○ denotes terminal common to TC9146AP/TC9147BP

# TC9146AP, TC9147BP

T-77-05-07

ELECTRICAL CHARACTERISTICS (Unless otherwise specified, Ta=25°C, VDD=5.0V)

CHARACTERISTIC		SYMBOL	TEST CIR-CUIT	TEST CONDITION	MIN.	TYP.	MAX.	UNIT
Supply Voltage		VDD		- *	4.5	5.0	5.5	V
Supply Current		IDD		FM Band, fIN=4MHz, No-Load	-	4.0	7.0	mA
Memory Backup Voltage		VDD B		INH=0V *	2.0	~	5.5	V
Inhibit Supply Current		IDD I1		VDD=5.0V, INH=0V	-	-	15	μA
		IDD I2		VDD=2.0V, INH=0V	-	-	5	
X'tal Oscillation Frequency		fx'tal		- *	-	7.2	-	MHz
FM <sub>IN</sub>	Operating Frequency	fIN(FM)		VIN=0.5V p-p, AC coupled *	2.0	~	4.0	MHz
	Input Amplitude	VIN(FM)		fIN=2.0 ~ 4.0 MHz, AC coupled *	0.5	~	VDD-0.5	Vp-p
AM <sub>IN</sub>	Operating Frequency	fIN(AM)		VIN=0.5Vp-p, AC coupled *	0.5	~	2.2	MHz
	Input Amplitude	VIN(AM)		fIN=0.5 ~ 2.2 MHz, AC coupled *	0.5	~	VDD-0.5	Vp-p
STOP3 (IFIN)	Operating Frequency	fIN(IF)		VIN=0.5Vp-p, AC coupled *	400	~	500	kHz
	Input Amplitude	VIN(IF)		fIN=400 ~ 500kHz, AC coupled *	0.5	~	VDD-0.5	Vp-p
PSC	FM <sub>IN</sub> Propagation Delay Time	t <sub>pd</sub>		CL=15pF, VIN=0.5Vp-p	-	-	200	nS
	Max. Load Capacity	CL		- *	-	-	15	pF
INH INT	Input Voltage	"H" Level	VIH1	-	4.2	~	VDD	V
		"L" Level	VIL1	-	0	~	3.0	
Other All Input I/O Terminals	Input Voltage	"H" Level	VIH2	-	3.5	~	VDD	V
		"L" Level	VIL2	-	0	~	1.5	
UP, DOWN, TEST Input Pull-Down Resistance		RIN		-	15	30	60	kΩ
FM <sub>IN</sub> , AM <sub>IN</sub> , STOP3 Feedback Resistance		Rf		-	200	400	800	kΩ
F1, 2, STOP1, 2, INH INT Input Leak Current		IL		-	-	-	1.0	μA

FM, MW, LW, MANUAL, AUTO, STO, (TC9146AP : M1 ~ M6, TC9147BP : M1 ~ M8)

Output Current	"H" Level	I <sub>OH</sub>		V <sub>OH</sub> =4.0V	15	20	-	mA
	"L" Level	I <sub>OL</sub>		V <sub>OL</sub> =5.0V	70	140	280	μA

OSC, MUTE, (TC9146AP : Pee, TC9147BP: DATA, CK1, 2, 0/5)

Output Current	"H" Level	I <sub>OH</sub>		V <sub>OH</sub> =4.0V	0.6	1.0	-	mA
	"L" Level	I <sub>OL</sub>		V <sub>OL</sub> =1.0V	0.6	1.0	-	mA

AUDIO DIGITAL IC

# TC9146AP, TC9147BP

T-77-05-07

CHARACTERISTIC	SYMBOL	TEST CIR-CUIT	TEST CONDITION	MIN.	TYP.	MAX.	UNIT
----------------	--------	---------------	----------------	------	------	------	------

## DO-1, DO-2

Output Current	"H" Level	I <sub>OH</sub>	V <sub>OH</sub> =4.0V	0.6	1.0	-	mA
	"L" Level	I <sub>OL</sub>	V <sub>OL</sub> =1.0V	0.6	1.0	-	
Try state Leak Current		I <sub>TL</sub>	-	-	-	0.1	μA

## MC1, MC2 (TC9147BP only)

Output Current	"H" Level	I <sub>OH</sub>	V <sub>OH</sub> =4.0V	0.6	1.0	-	mA
	"L" Level	I <sub>OL</sub>	V <sub>OL</sub> =5.0V	70	140	280	

## H1 ~ H4 (TC9146AP only)

Output Current	"H" Level	I <sub>OH</sub>	V <sub>OH</sub> =4.0V	15	18	-	mA
Leak Current at OFF		I <sub>L</sub>	V <sub>L</sub> =0V	-	-	1.0	

## L1 ~ L4 (TC9146AP only)

Output Current	"L" Level	I <sub>OL</sub>	V <sub>OL</sub> =1.5V	15	18	-	mA
Leak Current at OFF		I <sub>L</sub>	V <sub>L</sub> =5.0V	-	-	1.0	

Note : Parameters with \* mark are guaranteed at all conditions of V<sub>DD</sub>=4.5 ~ 5.5V  
T<sub>a</sub>=-30 ~ 75°C.

## FUNCTIONAL EXPLANATION OF TERMINALS

PIN NO.	SYMBOL	TERMINAL NAME	FUNCTION	REMARKS
2	XT	Crystal Oscillator terminal	Connect a 7.2 MHz crystal for reference frequency.	With a built in feedback resistor
3	$\overline{X}T$			
4	FM	FM band designating input	Mutual reset type for selecting FM/MW/LW bands	A
5	MW	MW band designating input		
6	LW	LW band designating input		
7	MANUAL	Manual tuning mode designating input	Mutual reset type for selecting manual and auto search operating modes at time of UP/DOWN tuning	A
8	AUTO	Auto search tuning mode designating input		
9	UP	Up operating key input	For UP/DOWN tuning with the push key connected	B
10	DOWN	DOWN operating key input		

TOSHIBA

# TC9146AP, TC9147BP

T-77-05-07

PIN NO.	SYMBOL	TERMINAL NAME	FUNCTION	REMARKS	
11	STO	Memory store command input	The preset memory is set to write state by this input	A	
12 17	M1 M6	Preset memory channel designating input	Controls write/read of preset memory of 6 channels of FM/AM (MW+LW)	A	TC9146AP
18 21	L1 L4	16 dots display Output	With a matrix formed with H1 ~ H4, used for analog display of receiving frequency in 16 dots.	H	
12 19	M1 M8	Preset memory channel designating input	In combination with MC1 and MC2 inputs, controls write/read of the internal 16 channel preset memory.	A	TC9147BP
20 21	MC1 MC2	Memory control input	Used for setting the 16 channel preset memory either to FM/AM (MW+LW) 8 channel fixed system or FM+MW+LW 3 bands 16 channel random system	C	
22	OSC2	AM oscillator terminal	C.R terminal for oscillator that decides SCAN speed at time of AM search.	-	
23	OSC1	FM oscillator terminal	C.R terminal for oscillator that decides SCAN speed at time of FM search.	-	
24 27	H4 H1	16 dots display output	With a matrix formed with L1 ~ L4, used for analog display of receiving frequency in 16 dots.	I	TC9146AP
24	0/5	FM 50kHz output for Europe	50kHz step output in FM band in European region. Become "H" level at 50 kHz.	D	TC9147BP
25	CK2	Receiving frequency data serial outputs	Transmits serial data and timing clock to be sent to Receiving Frequency Digital Display Driver TD6301AP. CK1 output also serves for pee sound transmission.	D	
26 27	CK1 DATA				
28	MUTE	Muting signal output	This terminal is placed at "H" level at time of muting output	D	
29 30	E2 E1	Region Designating output	For designating Japan, U.S.A and Europe.	E	
31	Pee	Pee sound signal Output	Outputs pee sound signal for confirming operation at time of key operation, etc.	D	TC9146AP
32	IFIN	AM-IF signal input	Counts IF 450 kHz signal at time of AM to stop auto search.	F	
33	STOP	Auto search stop signal	Stops auto search by inputting signal at "H" level.	E	

AUDIO DIGITAL IC

# TC9146AP, TC9147BP

T-77-05-07

PIN NO.	SYMBOL	TERMINAL NAME	FUNCTION	REMARKS
31	STOP3	AM-IF signal input	Stops auto search by counting IF 450 kHz signal at time of AM.	F
32	STOP2	Auto search stop signal input	When a "H" level signal is input under the state where a "H" level signal is being given to STOP1 Input, stops Auto search.	E
33	STOP1	SCAN speed slow input	When a "H" level signal is input, reduce auto search scan speed to 1/2.	E
34	DO-2	Phase Comparator output	2 try state buffers are transmitted parallelly from one phase comparator.	G
35	DO-1			
36	TEST	Test Terminal	When a "H" level signal is input, this terminal is placed at test mode.	B
37	FM <sub>IN</sub>	FM Programmable counter input	Output from prescaler TD6104P is connected.	F
38	PSC	Prescaler control output	Controls selection of 1/30 and 1/32 division of prescaler TD6104P	D
39	AM <sub>IN</sub>	AM programmable counter input	AM local oscillation signal is applied	F
40	$\overline{\text{INH}}$	Inhibit input	Normal operation at "H" level and inhibit status at "L" level.	E
41	$\overline{\text{INT}}$	Initialize input	Normal operation at "H" level, and internal state is initialized at "L" level.	E
42	VDD	Power terminals	Apply 5±0.5V. Backup is possible up to 2V.	-
1	GND			

## INPUT/OUTPUT EQUIVALENT CIRCUIT

A. Bipolar Transistor LED Driver Built-in I/O.

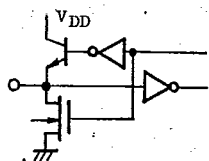

B. C-MOS Input with Pull-Down Resistor

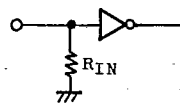

C. C-MOS I/O

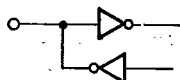

D. C-MOS Output

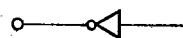
**TOSHIBA**

# TC9146AP, TC9147BP

T-77-05-07

E. C-MOS Input (without Pull-up, Pull-Down Resistor)

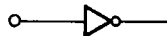

F. With Built-in Input Amplifier

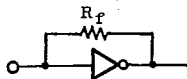

G. Try-state Output

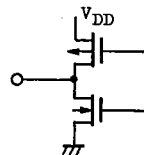

H. Nch MOS LED Driver Output

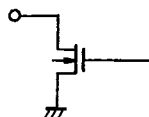

I. Bipolar Transistor LED Driver Output

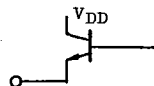

## OUTLINE OF FUNCTIONS

### 1. RECEIVING BANDS

- 1) FM/MW/LW bands can be received in European region and FM/AM bands in Japan and U.S.A.
- 2) AM band for U.S.A is able to receive up to 1710 kHz, and 9 kHz separation is also available.

Note: \* mark AM 522~1629kHz at TC9147BP, 522~1611kHz at TC9146AP.

Desti- nation	Band Name	Range of Receiving Frequency	IF	Frequency Stop	Reference Frequency	Remarks
Europe	FM	87.50 ~ 108.00 MHz	+10.7MHz	50 kHz	25 kHz	FM Europe 50kHz separation
	MW	522 ~ 1611 kHz	+450 kHz	9 kHz	9 kHz	MW 9kHz separation
	LW	153 ~ 360 kHz	+450 kHz	1 kHz	1 kHz	1kHz separation
U.S.A.	FM	87.5 ~ 108.0 MHz	+10.7MHz	100 kHz	25 kHz	FM U.S.A band
	AM-1	520 ~ 1710 kHz	+450 kHz	10 kHz	10 kHz	MW U.S.A 10 kHz separation
	AM-2	522 ~ 1710 kHz	+450 kHz	9 kHz	9 kHz	MW U.S.A 9 kHz separation
Japan	FM	76.0 ~ 90.0 MHz	-10.7MHz	100 kHz	25 kHz	FM JAPAN band
	AM	522 ~ * kHz	+450 kHz	9 kHz	9 kHz	MW 9kHz separation

AUDIO DIGITAL IC



# TC9146AP, TC9147BP

T-77-0507

## 2. TUNING FUNCTION

- 1) Manual tuning with UP/DOWN Key
  - 1 step/push step tuning
  - Fast forward tuning with UP/DOWN key pushed continuously
- 2) Auto search tuning by 1 push of UP/DOWN key
  - ARI or stereo channel only can be searched.(TC9147P only)
  - AM auto stop circuit can be simplified through IF count system.
  - SCAN speed can be set independently for FM/AM.
- 3) Preset tuning by memory read.

## 3. PRESET MEMORY AND LAST FREQUENCY MEMORY

- 1) Preset memories for 16 channels have been built in (TC9147BP)
  - Either the FM/AM (MW+LW) 8 channels allocation system and the 16 channels random selection system regardless of band are available.
  - Further, on TC9146AP the preset memory is of 6 channels fixed type for FM/AM (MW+LW).
- 2) Last Frequency Memory has been provided for each band of FM/MW/LW
  - The last frequency memory is capable of storing frequency data and preset memory channel Number at that time (Last channel memory function)
- 3) All memories are consisting of static C-MOS RAM for realizing low voltage and low power consumption.

## 4. DISPLAY FUNCTION

- 1) All displays are of static type.
- 2) LED Drivers have been built in for band, MANUAL/AUTO and memory channel display.
- 3) The receiving frequency display has the following two kinds.
  - TC9146AP : Method of linear display by dotting of LED lamp.
  - TC9147P : Method of digital display by connecting TC6301AP.

# TC9146AP, TC9147BP

T-77-0507

## 5. INHIBIT FUNCTION

The inhibit function inhibits all input/output and completely stops LSI operation including oscillation of OSC. This function makes it possible to back up the receiving state including memory contents for a long hour by a capacitor or battery when the power supply of the set is OFF.

## EXPLANATION OF OPERATION

### PLL UNIT

#### 1. REFERENCE FREQUENCY AND CRYSTAL OSCILLATOR

Oscillation frequency from the crystal oscillator is divided to generate reference frequency of 25kHz at time of FM, 9 or 10kHz at MW and 1kHz at LW.

- Crystal oscillation frequency is 7.2 MHz
- The crystal oscillator has a built-in self-bias amplifier and can be composed easily only by connecting a crystal and a capacitor as shown in the following diagram. Further, oscillation is stopped under the inhibit state.

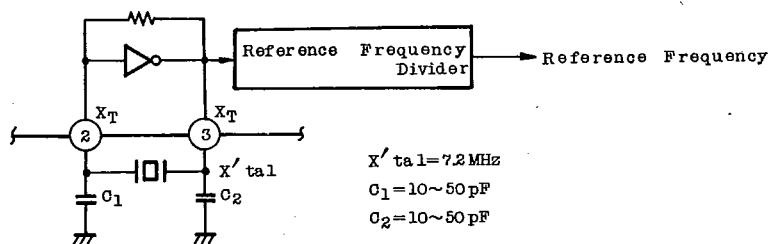

\* A crystal that has a low CI value and excellent starting

MODE	REFERENCE FREQUENCY	REMARKS
FM	25 kHz	at FM band
MW 9	9 kHz	at MW 9kHz separation
MW 10	10 kHz	at MW 10kHz separation
LW	1 kHz	at LW band

# TC9146AP, TC9147BP

T-77-05-07

## 2. PROGRAMMABLE COUNTER

The programmable counters for FM and AM (MW/LW) are in different circuit configuration.

### 1) FM Programmable Counter

The FM programmable counter is of swallow count type in combination with TD6104P. As a result, reference frequency 25 kHz is obtained and performance is improved.

The following diagram shows the connection with prescaler TD6104P.

In this case, the transmission delay time of PSC output for controlling TD6104P is limited. Therefore, wiring for this PSC output should be as short as possible. PSC transmission delay time  $t_d < 250$  ns.

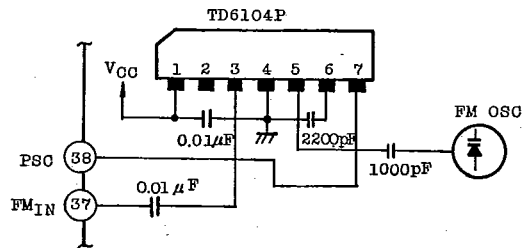

### 2) AM Programmable Counter

The AM (MW/LW) programmable counter is of direct division type.

The signal transmitted from AM channel can be directly input to AM<sub>IN</sub> terminal.

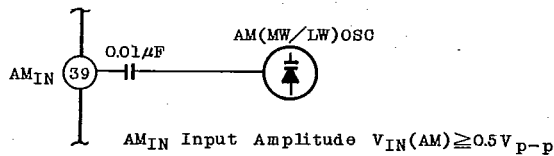

- As both FM<sub>IN</sub> and AM<sub>IN</sub> have a built-in input amplifier, a signal shall be applied with a capacitor connected.
- Under the inhibit state and at AM (MW/LW), PSC output is fixed at "L" level.
- IF offset has been provided in advance for frequency division by the programmable counter.

# TC9146AP, TC9147BP

T-77-05-07

### 3. PHASE COMPARATOR

The phase comparator is a unit that compares phases of reference frequency and programmable counter output and controls VCO through the low pass filter so that thus two signal frequencies and phases agree each other.

- Two tri-state buffers DO-1 and DO-2 are transmitted parallely from one phase comparator. Because of this, two sets of low-pass filter can be used without necessity for switching them.
- Under the inhibit state, both DO-1 and DO-2 outputs are kept at "L" level.

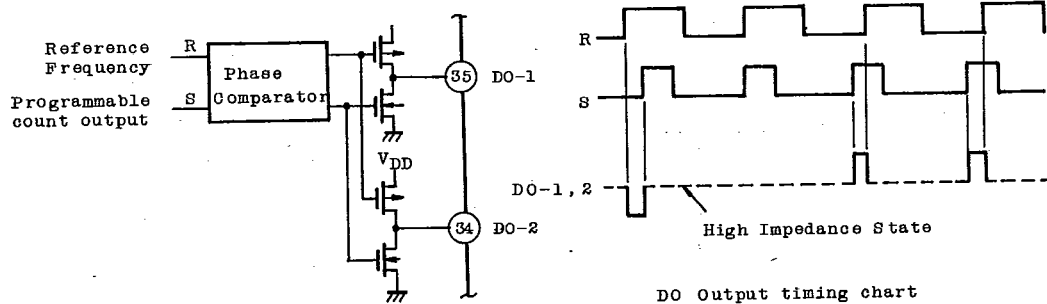

An example of the low-pass filter to be connected to DO-1 and DO-2 outputs is shown below. This is an active low-pass filter through the Darlington connection of FET and transistor.

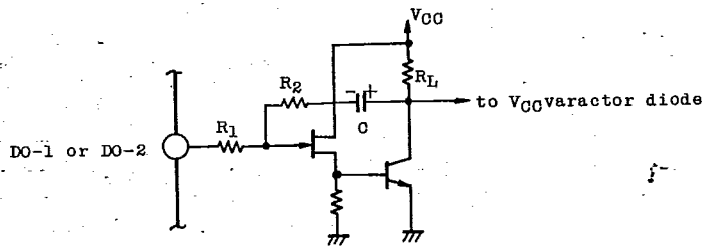

Low-pass filter constant (standard value)

- C = 0.33  $\mu$ F
- R1 = 10 k $\Omega$
- R2 = 8.2 k $\Omega$
- RL = 10 k $\Omega$

# TC9146AP, TC9147BP

T-77-05-07

9097247 TOSHIBA. ELECTRONIC

02E 18011 D

## CONTROL UNIT

### 1. DETERMINATION OF OSC1 AND OSC2 OSCILLATION FREQUENCY

OSC1 and OSC2 are C and R connecting terminals of a single terminal type oscillator. Scan speed at time of manual fast forward and auto search is decided by this frequency.

OSC1 is for FM and OSC2 is for AM and oscillation frequency can be set independently. Further, OSC1 oscillation frequency also serves for deciding manual fast forward pushing time, muting signal transmission time and store state automatic releasing time.

Both OSC1 and OSC2 stop oscillation unless it is required.

$$\text{Oscillation Frequency } f_{\text{OSC}} = \frac{1}{0.7 C_X R_X} \text{ (Hz) (Note 2)}$$

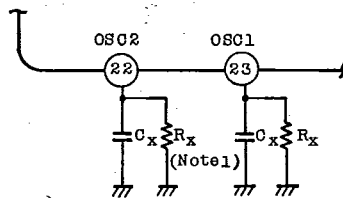

(Note 1)  $R_X = 10k \sim 100k\Omega$

(Note 2) Refer to Graph (1) shown later.

Scan Speed (Fast FWD. Auto Search)	At FM	$f_s(\text{FM}) = \frac{1}{2} f_{\text{OSC1}}$ (step/sec)	(One Example) When $f_{\text{OSC}} = 20\text{Hz}$	10 (step/sec)
	At AM(MW/LW)	$f_s(\text{AM}) = \frac{1}{2} f_{\text{OSC2}}$ (step/sec)		10 (step/sec)
Manual Fast FWD Push Time		$T_{\text{SCAN}} = 14 / f_{\text{OSC1}}$ (sec)		0.7 (sec)
Store State Auto Release Time		$T_{\text{STO}} = 224 / f_{\text{OSC1}}$ (sec)		11 (sec)
Muting Signal Output Time	Short	$T_{\text{MUTE(S)}} = 7 / f_{\text{OSC1}}$ (sec)		0.35 (sec)
	long	$T_{\text{MUTE(L)}} = 15 / f_{\text{OSC1}}$ (sec)		0.75 (sec)

(Note)  $f_{\text{OSC1}}$  : OSC1 Oscillation Frequency,  $f_{\text{OSC2}}$  : OSC2 Oscillation Frequency

**TOSHIBA**

# TC9146AP, TC9147BP

T-77-05-07

## 2. DESIGNATION OF DESTINATION BY JAPAN, U.S.A AND EUROPE

Regional designation by Japan, U.S.A and Europe is made by E1 and E2 terminals.

E1	E2	Destination	
0	0	Japan	
1	0	Europe	
0	1	U.S.A.	MW 9 kHz separation
1	1		MW 10 kHz separation

- For U.S.A region designation, AM(MW) band 9 kHz/10 kHz separation can be selected.
- When the  $\overline{INH}$  terminal is placed at "L" level, E1 and E2 Inputs inhibit read operation and keep the previous state.

## 3. SELECTION OF RECEIVING BAND

The receiving bands are selected by the FM, MW and LW terminal inputs. 3 bands of FM/MW/LW are selected for European region designation and 2 bands of FM/AM (MW) for Japan and U.S.A designation.

- FM, MW and LW inputs are of mutual reset type and are "H" level active.
- I/O type with a built-in bipolar transistor driver, and the band display by LED is possible.
- Has the internal latch circuit and able to correspond to either the push key or lock switch. The key connection is shown in the following diagram. However, when the lock switch is used, different band memory channels under the random memory system cannot be read.
- Input by multiple pushing the key is not accepted and muting output becomes "H" level.
- No LW input is accepted in Japan and U.S.A designation.

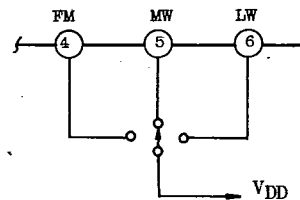
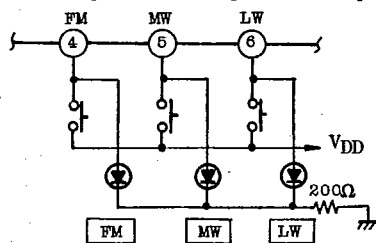

AUDIO DIGITAL IC

# TC9146AP, TC9147BP

T-77-05-07

## 4. UP/DOWN TUNING METHOD

This type of tuning is made by 4 input terminals : MANUAL, AUTO, UP and DOWN.

### (1) Connection of **MANUAL**, **AUTO**, **UP** and **DOWN** keys

The MANUAL and AUTO Inputs are in the same circuit configuration as the above-mentioned band selecting terminal.

- Display LED can be connected
- Either the push key and lock switch can be used.

The push key should be connected to the Up and Down keys. Further, these 4 inputs terminals are all "H" level active.

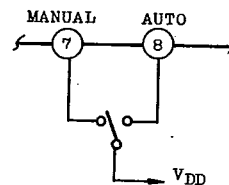
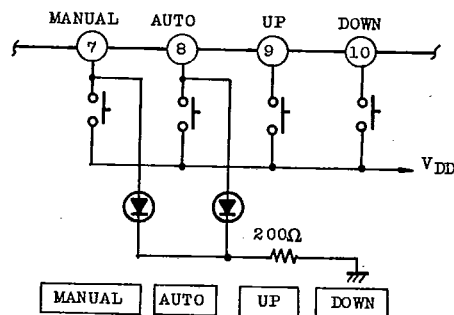

When MANUAL/AUTO Lock key is used.

### (2) Manual 1 step/1 push tuning

- Push **MANUAL** key for the manual tuning mode.
- When **UP** or **DOWN** is pushed for a short period, receiving frequency is up or down at the above frequency step.
  - If the band edge is reached when the **UP** or **DOWN** input is continuously applied, key input is no more accepted and the tuning is stopped.
  - The UP or DOWN input has been set at fast acceptance timing and a short on time rotary switch can be used.

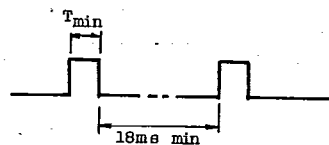

Min pulse width of UP/DOWN input accepted  $T_{min} \approx 2.5 \text{ ms}$

(Input during this period is not accepted.)

# TC9146AP, TC9147BP

## (3) Manual Fast Forward Tuning

T-77-05-07

- (a) Set at Manual Tuning Mode as in (2).
- (b) When the **UP** or **DOWN** key is pushed continuously for a fixed time ( $T_{SCAN}$ ), receiving frequency is fast forwarded and scan is mode, and the key is released, Scan is stopped.
- When the band edge is reached, Scan is stopped.
  - Key push time ( $T_{SCAN}$ ) and Scan speed  $f_s$ (FM) at FM are decided by  $f_{OSC1}$  oscillation frequency ( $f_{OSC1}$ ). Further, Scan speed  $f_s$ (AM) at AM (MW/LW) is decided by  $f_{OSC2}$  oscillation ( $f_{OSC2}$ ).

$$T_{SCAN} = \frac{14}{f_{OSC1}} \text{ (sec)}, \quad f_s \text{ (FM)} = \frac{f_{OSC1}}{2} \text{ (step/sec)},$$

$$f_s \text{ (AM)} = \frac{f_{OSC2}}{2} \text{ (step/sec)}$$

$$(f_{OSC1} = 20\text{Hz}, T_{SCAN} = 0.7 \text{ sec})$$

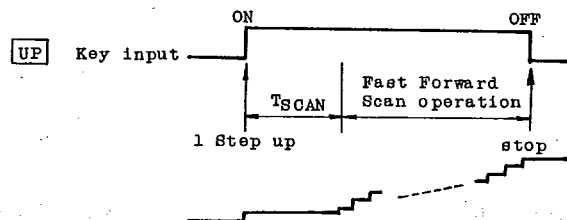

- As long as the **MANUAL** and **AUTO** keys are pushed simultaneously, the manual mode is kept.
- Simultaneous inputs of the **UP** and **DOWN** keys are not accepted.

## (4) Auto Search Tuning

The auto search tuning is the function that automatically searches and receives broadcasting frequency.

### (4-1) Auto Search Tuning Method

- (a) Push the **AUTO** key to set at the auto search tuning mode.
- (b) When the **UP** key is pushed by one push, Scan is started in the up direction. When the **DOWN** key is pushed, Scan is started in the down direction. In this case, Scan is not stopped even when the key is released.



# TC9146AP, TC9147BP

T-77-05-07

(c) When Auto Stops Signal is received (when there is a broadcasting station), Scan is stopped.

- The auto search tuning scan system is in triangular waveform shape.
- When the **DOWN** key is pushed during the scanning in the up direction, the scanning is changed in the down direction. Similarly, when the **UP** key is pushed during the scanning in the down direction, the scanning is reversed in the up direction.

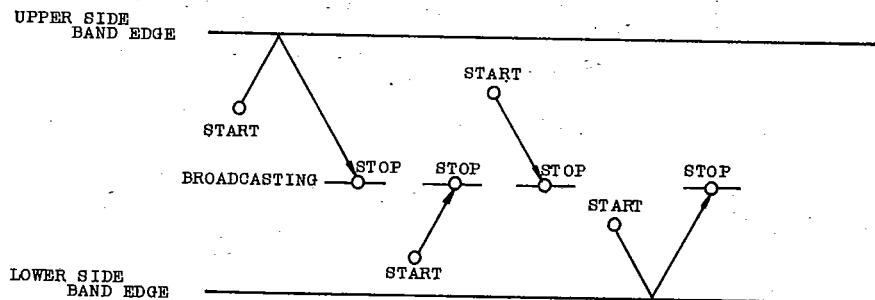

- The auto search scan speed is same as the fast forward scan speed  $f_s(\text{FM})$  at FM,  $f_s(\text{AM})$  at AM (MW/LW).  
The auto search tuning is released when the following operation is mode :

When the operating mode is changed to the manual scan mode.

When a receiving band is changed.

When the preset memory is read.

When the status is changed to the inhibit state.

- When the **UP** or **DOWN** key is kept pushed during the auto search tuning, no auto stop signal is accepted. In addition, the band edge is reached, the auto search tuning is stopped.

#### (4-2) Method of use of Auto stop terminals (STOP1, STOP2, STOP3) (TC9147BP)

- When a "H" level signal is applied to STOP1 input, auto search scan speed is reduced to 1/2 (Slow mode).
- When a "H" level signal is applied to STOP2 terminal under the slow mode (STOP1=at "H" level), the auto search tuning is stopped.

Through the above operations, it is possible to stop the auto search after searching ARI or Stereo station only.

**TOSHIBA**

# TC9146AP, TC9147BP

T-77-06-07

(a) Method of auto stop signal input during normal auto search.

Input the auto stop signal to both STOP1 and STOP2 terminal, or with STOP2 terminal fixed at "H" level, apply the auto stop signal to STOP1 terminal.

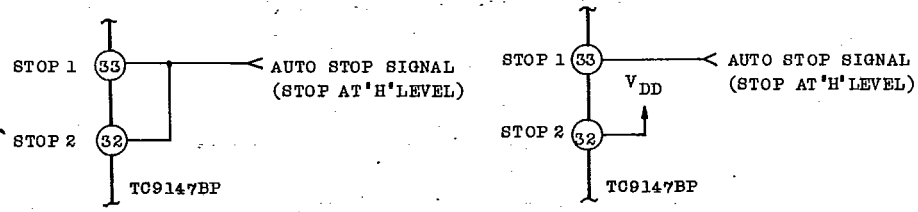

(b) When ARI or Stereo Station only is searched

Apply the normal auto stop signal to STOP1 terminal. Apply ARI or Stereo Station identification signal to STOP2 terminal ("H" level shows ARI or Stereo Station).

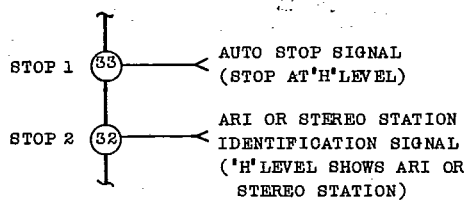

STOP1 and STOP2 input timing chart is shown below:

As shown in the chart, STOP1 and STOP2 input detection is made at the last scan time. This provides a margin to stop signal time constant.

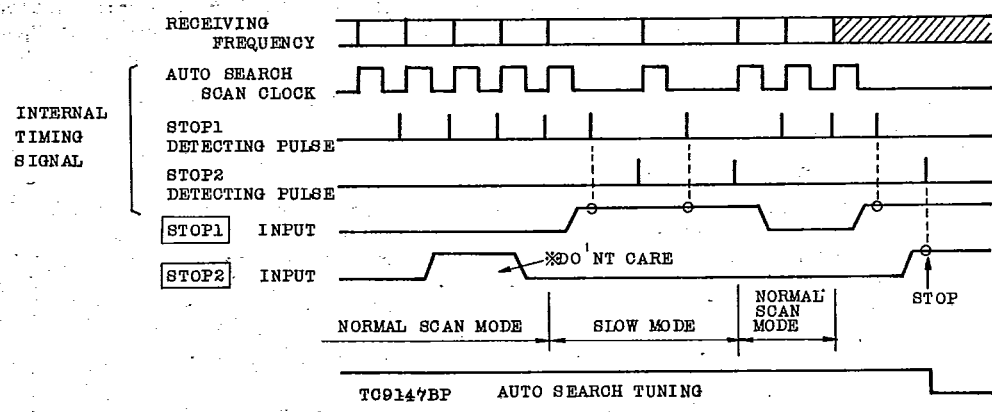

AUDIO DIGITAL IC

# TC9146AP, TC9147BP

T-77-05-07

## IF<sub>IN</sub> (TC9146AP)/STOP3 (TC9147BP) terminal

This terminal is the input of IF signal (=450 kHz) at time of AM (MW/LW). When this input frequency enters the specified range against 450 kHz, auto search tuning stops.

- As the input amplifier has been built in, apply IF signal with the capacitor connected.
- IF<sub>IN</sub>, STOP3 input is not accepted at time of FM.
- Range of Auto Tuning stopping.

MW Band	450 kHz ± about 3 kHz
LW Band	450 kHz ± about 600 Hz

- Since IF signal has been amplitude modulated, it is adequate to apply it to IF<sub>IN</sub>, STOP3 terminal through the limiter amplifier.

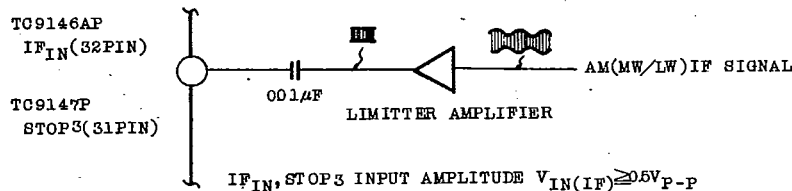

### (Cautions)

- At AM, the auto stop is actuated to either STOP1 and 2 input and STOP3 input. For the reason of this, STOP1 and 2 inputs shall be fixed at "L" level when STOP3 terminal is used. (TC9147BP) For TC9146AP, if IF<sub>IN</sub> is used, STOP input is fixed to "L" level.
- When IF<sub>IN</sub>, STOP3 terminal is not used, in order to prevent malfunctions due to noise, etc., this terminal should be directly connected to V<sub>DD</sub> terminal.

## 5. MEMORY FUNCTION

### (1) Preset Memory

This is the function for tuning a desired channel by one-touch by constantly storing optional frequency data. The preset memory of TC9147BP is explained in the following. The preset memory of TC9146AP will be separately explained.

# TC9146AP, TC9147BP

T-77-05-07

## (1-1) Connection of keys concerning memory (TC9147BP)

The terminals concerned with the memory are STO, M1 ~ M8, MC1, and MC2, a table of 11 terminals. Inputs are all "H" level active.

- STO and M1 ~ M8 terminal are of I/O type with a built-in bipolar transistor status display driver.
- MC1 and MC2 terminals control the built-in 16 channel preset memories as shown in the following table.

MC1	MC2	Allocation of 16 channel preset memories	Memory type
1	0	Memory addresses for 1 ~ 8 channels are assigned by M1 ~ M8 terminals	16 channel random memory system
0	1	Memory addresses for 9 ~ 16 channels are assigned by M1 ~ M8 terminals	
1	1	No input is accepted. Memory allocation holds the previous status.	
0	0	Automatically allocated to 8 FM channels and 8 AM channels. Further, at time of AM, MW and LW band random system.	8 FM/AM channel fixed memory system

- MC1 and MC2 Inputs are of mutual resetting I/O type with an internal latch circuit.

(Note) MC1 and MC2 terminals are of C-MOS I/O type and has no built-in driver.

## (a) Random memory system (TC9147BP)

This is the method to use 16 channel memories at random independently of frequency bands.

- In this random memory system, frequency bands are automatically changed according to memory read. Therefore, a push type key is used for the band selecting switch.

(Note) When band input is placed in the locked status (a state where the key is kept pushed or in case of a lock switch), no memory, for different band can be read.

# TC9146AP, TC9147BP

T-77-05-07

- When 8 memory keys are used.

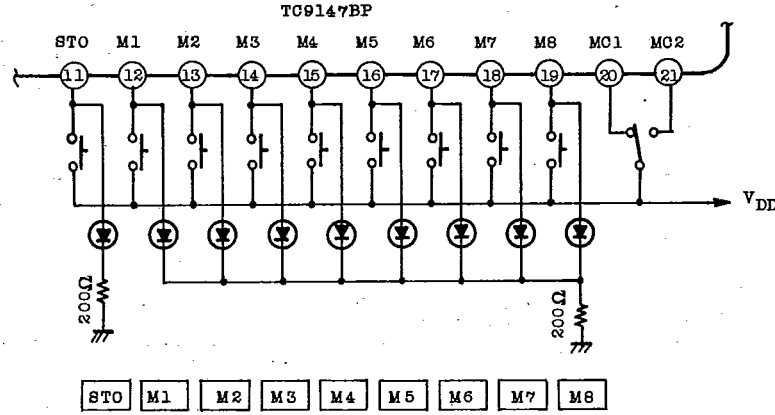

In this case, it is necessary to select memories for either channel 1~8 or channel 9~16 by MC1/MC2 switch prior to read/write.

- When 16 memory keys are used.

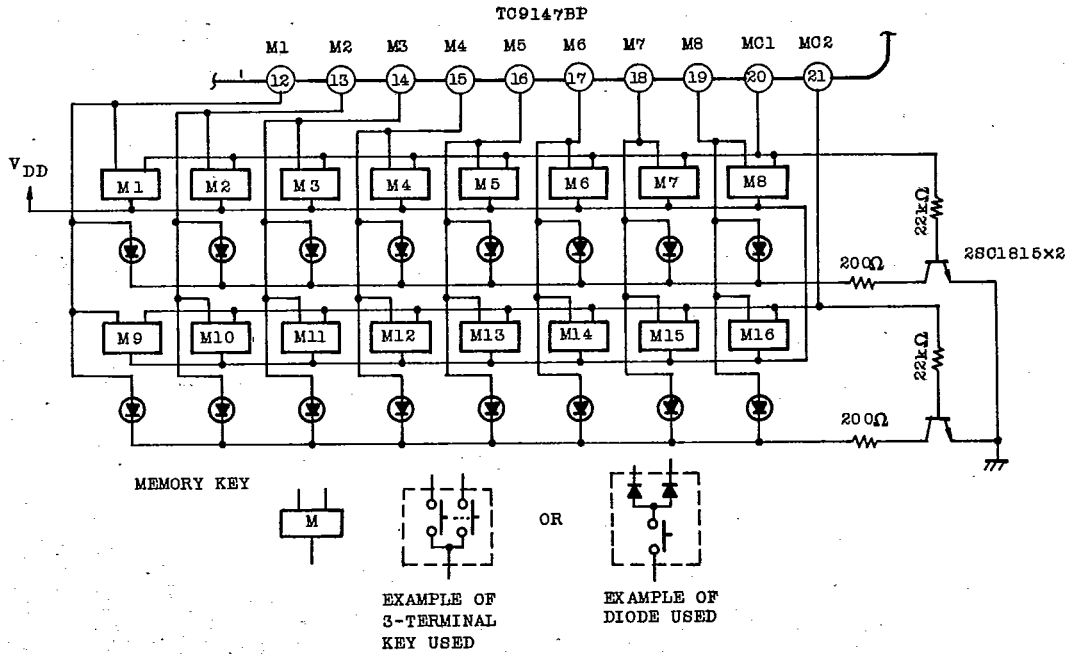

**TOSHIBA**

# TC9146AP, TC9147BP

T-77-05-07

(b) FM/AM 8 channel fixed memory system (TC9147BP)

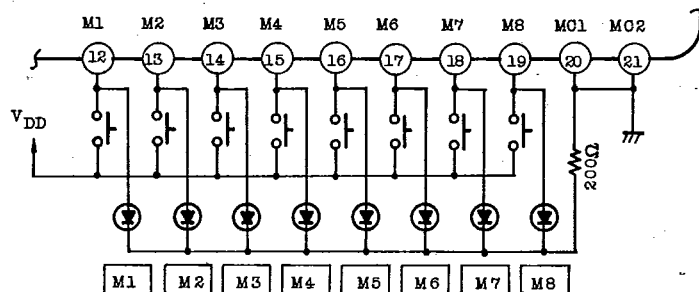

For European region, the memory system at AM becomes the MW and LW band 8 channel random system.

### (1-2) Memory Write Method

- (a) Push **STO** key. The STO display lamp illuminates and it becomes the memory writable state. (Store state)
- (b) Then, push a desired memory key. The STO lamp is turned OFF and the assigned memory channel lamp illuminates. Now, receiving frequency data at the time is stored in the memory.
  - Unless the memory key is pushed after pushing the **STO** key, the store state is automatically released after a certain time.

Store state automatic release time  $T_{STO} = \frac{224}{f_{OSC1}}$  (sec)

(If  $f_{OSC1} = 20\text{Hz}$ ,  $T_{STO} = 11\text{sec}$ )

Further, the store state is also released when a band is changed, UP/DOWN key is pushed and the system is placed in the inhibit state.

### (1-3) Memory Read Method

When a desired memory key is only pushed, that memory channel can be read.

- If a memory storing data outside the band edge is read out, that data is corrected by force to the lower band edge (when power is newly turned on).

AUDIO DIGITAL IC

# TC9146AP, TC9147BP

T-77-05-07

## (2) Last Frequency Memory

This is the Sub-Memory used at time of band changing for storing data before the band change. At time of the band changing, write/read is automatically executed.

- The last frequency memory is capable of storing channel number of the preset memory at that time.
- When a band is changed by the preset memory read in the random memory system, the preset memory data has priority.

### Example of last Frequency memory operation

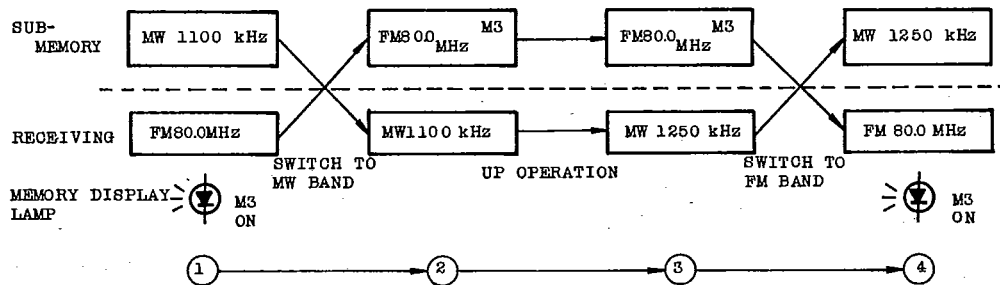

## 6. RECEIVING FREQUENCY DISPLAY (TC9147BP)

The frequency display of TC9147BP is explained here. The linear display of TC9146AP will be separately explained. Receiving frequency is displayed using the external static display driver TC6301AP.

Receiving frequency data is serially transferred to TD6301AP through DATA, CK1 and CK2 terminals.

- The Output timings of DATA, CK1 and CK2 terminal are shown in the following diagram.

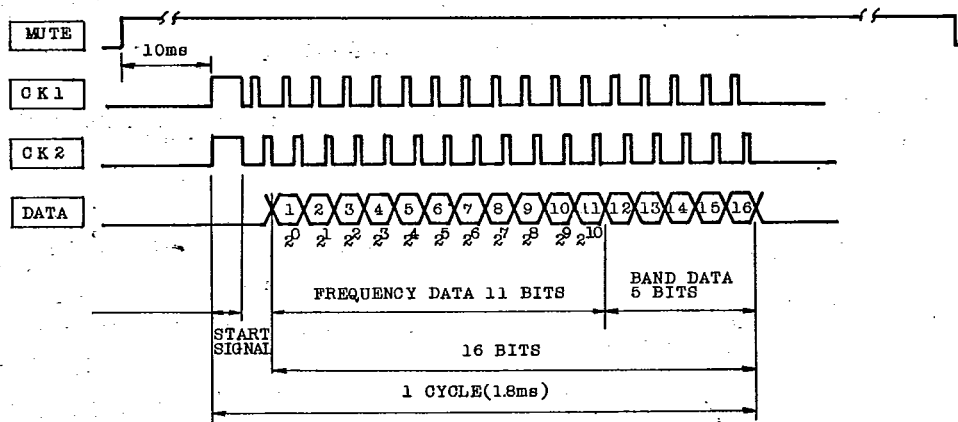

# TC9146AP, TC9147BP

T-77-05-07

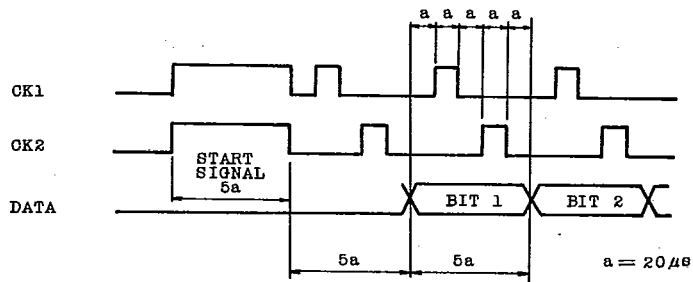

### (1) DATA Output

Frequency data and band data are serially transmitted in 16 bits. 1~11 bits are frequency data and 12~16 bits are band data.

- Frequency Data

This is a value of receiving frequency minus the lower band edge of that band. This value is transmitted in binary 11 bits.

- Band data are as shown in the table.

bit 12	13	14	15	16	Band
1	0	0	0	0	LW Band
0	1	0	0	0	FM JAPAN Band
0	0	1	0	0	FM USA/Europ Band
0	0	0	1	0	MW 9 kHz separation
0	0	0	0	1	MW 10 kHz separation

### (2) CK1, CK2 Output

These outputs are timing clocks for reading DATA output by TD6301AP. DATA, CK1 and CK2 outputs are transmitted by are cycle only in the following cases :

- When the inhibit state is released.
- When a band is changed.
- When the preset memory is read.
- At time of UP/DOWN tuning.

AUDIO DIGITAL IC



# TC9146AP, TC9147BP

T-77-05-07

### (3) 50 kHz Frequency Display in FM Band for Europe

The 50 kHz display in FM Band for Europe is made at 0/5 output.

- At time of 50 kHz, output will become "H" level. When other areas are assigned or at time of MW and LW bands, output is fixed at "L" level.

Example of Display by 7-Segment LED.

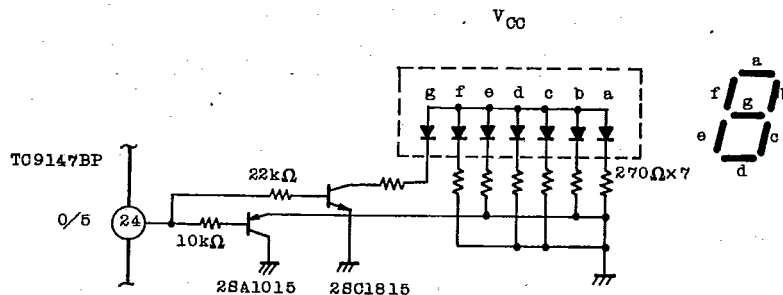

### 7. MUTING OUTPUT

In order to prevent generation of abnormal sound at time of key operation, muting signal is transmitted from the MUTE terminal at the timings shown in the following diagrams.

- Muting output time at time of restoration from the inhibit state or band switching is extended to about 2 times of that in normal cases. (This is also true when a band is changed according to the memory read in the random memory system.)
- When the multiple band input keys are pushed or during the fast forwarding or auto search tuning, muting output is kept at "H" level.
- The receiving channel (division of the programmable counter) changes 12 mS later after muting signal is transmitted. This will provide a margin to muting application time.

#### (1) Manual UP/DOWN, Memory Read

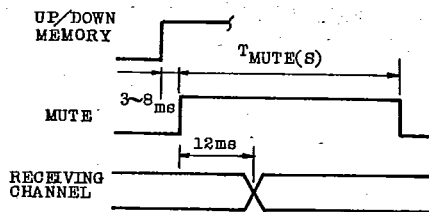

#### (2) Restoration from Inhibit status, Band Switching

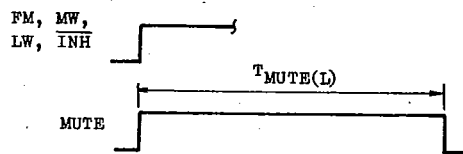

# TC9146AP, TC9147BP

T-77-05-07

### (3) Manual Fast Forward

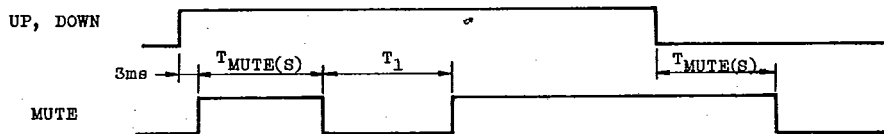

### (4) Auto Search Tuning

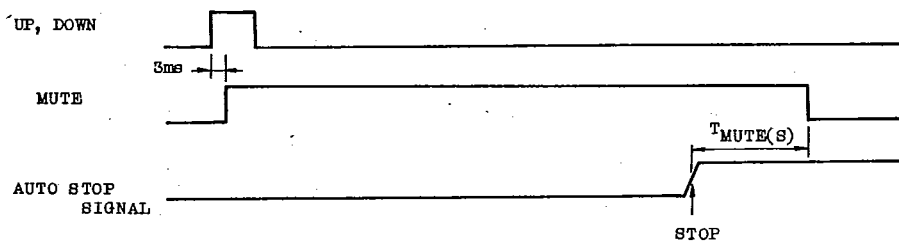

$$T_{MUTE(L)} = \frac{15}{f_{osc1}} \text{ (sec) } (=750\text{ms})$$

$$T_{MUTE(S)} = T_1 = \frac{7}{f_{osc1}} \text{ (sec) } (=350\text{ms})$$

(at  $f_{osc1}=20\text{Hz}$ )

## 8. INHIBIT FUNCTION

This is the function to back up memory contents and receiving state when the power supply of a set is OFF. When the  $\overline{INH}$  terminal is set at "L" level a set is placed in the inhibit state.

### (1) Operation under inhibit state

- Crystal oscillation is stopped and all operations will reset.
- All input keys is not accept.

All transistor for the drivers are turned OFF and all other outputs are held at "L" level.

As the result of above operations, current consumption at the inhibit state is reduced extremely. Therefore, the back up by means of battery or capacitor will become possible.

AUDIO DIGITAL IC

# TC9146AP, TC9147BP

T-77-05-07

(Cautions)

- When the  $\overline{\text{INH}}$  terminal is placed at "L" level, the programmable counter until is shifted to the inhibit state after fixing PSC output at "L" level and setting the counter internal state. At this operation is executed by using a programmable counter input signal,  $\text{AM}_{\text{IN}}$  or  $\text{FM}_{\text{IN}}$  input signal should be kept applied for more than 3ms after the  $\overline{\text{INH}}$  terminal has been set at "L" level.

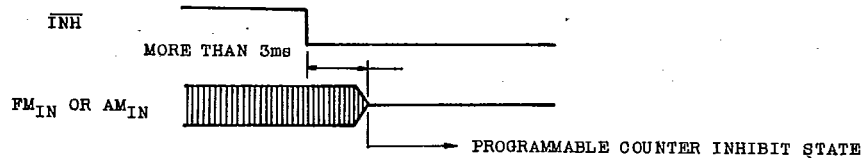

- When the  $\overline{\text{INH}}$  terminal is set at "L" level, a series of operations is executed in the inside of LSI for shifting to the inhibit state. It is necessary to apply normal voltage (4.5 ~ 5.5V) to  $V_{\text{DD}}$  terminal during this series of operations. Thereafter,  $V_{\text{DD}}$  can be reduced to backup voltage (2V).

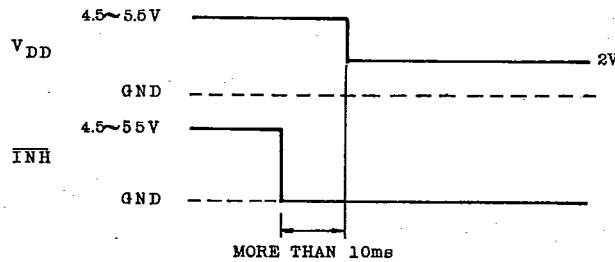

- As mentioned above, E1 and E2 terminals inhibit read when the  $\overline{\text{INH}}$  terminal is at "L" level. However, data read is immediately started when the  $\overline{\text{INH}}$  terminal is placed at "H" level. Therefore, rise of  $\overline{\text{INH}}$  input should be delayed more than  $V_{\text{DD}}$ .

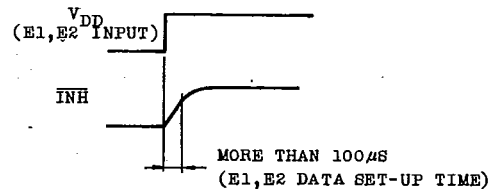
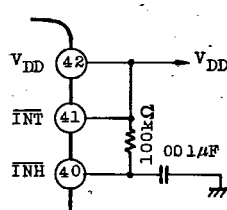

# TC9146AP, TC9147BP

T-77-05-07

(2) Examples of Back up Circuit

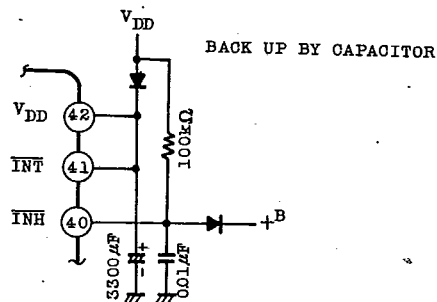
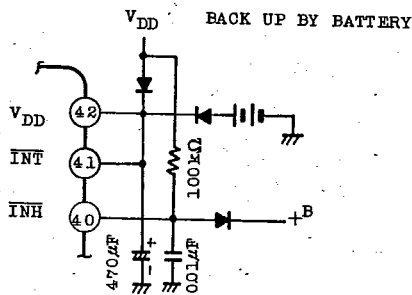

+B shall be connected to a fast fall power supply when the power switch of a set is turned OFF.

9. PEE SOUND OUTPUT

At time of key operation or during scanning, the pee sound signal for confirming the operation is output from CK1 terminal. (TC9147BP)  
This signal is output after the timing clock signal has been output to TD6301AP.

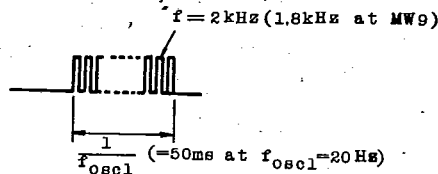
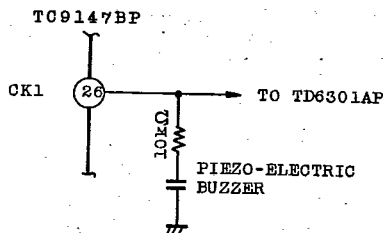

For TC9146AP, the pee sound signal is output to the pee output terminal.

