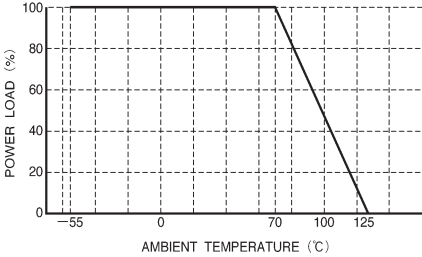

Thick film rectangular MCR25 (3225 size: 1 / 4W)

●Features

- 1) Made of same material as the general purpose chip resistors (MCR10 / 18).
 - 2) Highly reliable chip resistor
Ruthenium oxide resistive material offers superior resistance to the elements.
 - 3) Electrodes not corroded by soldering
 - 4) ROHM resistors have approved ISO-9001 certification.
- Both flow and reflow soldering can be used.
Design and specifications are subject to change without notice. Carefully check the specification sheet before using or ordering it.

●Ratings

Item	Conditions	Specifications	
Rated power	Power must be derated according to the power derating curve in Figure 1 when ambient temperature exceeds 70°C. 	0.25W (1 / 4W) at 70°C	
Rated voltage	The voltage rating is calculated by the following equation. If the value obtained exceeds the maximum operating voltage, the voltage rating is equal to the maximum operating voltage. $E = \sqrt{P \times R}$ E: Rated voltage (V) P: Rated power (W) R: Nominal resistance (Ω)	Max. operating voltage	200V
		Max. overload voltage	400V
		Max. intermittent overload voltage	400V
Nominal resistance	See Table 1.		
Operating temperature		-55°C to +125°C	

Jumper type

Resistance	Max. 50mΩ
Rated current	2A
Peak current	10A
Operating temperature	-55°C to +125°C

Table 1

Resistance tolerance		Resistance range (Ω)	Resistance temperature coefficient (ppm / °C)
F (±1%)		10 ≤ R ≤ 1M (E24,96)	±200
J (±5%)	JB*	0.47 ≤ R < 1.0 (E6)	500 ± 350
	J	1.0 ≤ R < 2.2 (E24)	
		2.2 ≤ R < 5.6 (E24)	±500
		5.6 ≤ R ≤ 3.3M (E24)	±200

Asterisk (*) indicates special specifications.

●Before using components in circuits where they will be exposed to transients such as pulse loads (short-duration, high-level loads), be certain to evaluate the component in the mounted state. In addition, the reliability and performance of this component cannot be guaranteed if it is used with a steady state voltage that is greater than its rated voltage.

●Characteristics

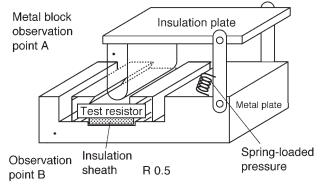
Characteristics	Specifications		Test method
	Chip resistance	Jumper type	
DC resistance	F : $\pm 1\%$ J : $\pm 5\%$	Max. 50m Ω	JIS C 5202 5.1 Applied voltage: A
Resistance temperature characteristics	See Table 1.		JIS C 5202 5.2 Test conditions: +25 / -55 / +25 / +125 $^{\circ}$ C.
Short time overload	$\pm (2.5\%+0.1\Omega)$	Max. 50m Ω	JIS C 5202 5.5 Rated voltage (current): $\times 2.5$, 5s. Maximum overload voltage: 400V
Insulation resistance	Min. 1,000M Ω between terminal and board		JIS C 5202 5.6 Test voltage: 100V, 1min. <u>Assembled state</u> 
Withstand voltage	Do not damage insulation or cause a short circuit.		JIS C 5202 5.7 Test voltage: 500V
Intermittent overload	$\pm (5.0\%+0.1\Omega)$	Max. 50m Ω	JIS C 5202 5.8 Rated voltage (current): $\times 2.5$ (1s: ON — 25s: OFF) $\times 10,000$ cyc.
Terminal strength (against bending of circuit board)	$\pm (1.0\%+0.05\Omega)$ There must be no mechanical damage.	Max. 50m Ω	JIS C 5202 6.1
Resistance to soldering heat	$\pm (1.0\%+0.05\Omega)$ Outside must not be noticeably damaged.	Max. 50m Ω	JIS C 5202 6.4 Soldering conditions: 260 $\pm 5^{\circ}$ C Soldering time: 10 ± 1 s.
Solderability	95% of terminal surface must be covered by new soldering, and there must be no soldering corrosion.		JIS C 5202 6.5 Rosin methanol: (25%WT) Soldering conditions: 235 $\pm 5^{\circ}$ C Soldering time: 2.0 ± 0.5 s.
Resistance to dry heat	$\pm (3.0\%+0.1\Omega)$	Max. 100m Ω	JIS C 5202 7.2 125 $^{\circ}$ C Test time: 1,000 to 1,048 hrs.
Endurance (rated load)	$\pm (3.0\%+0.1\Omega)$	Max. 100m Ω	JIS C 5202 7.10 Rated voltage (current), 70 $^{\circ}$ C 1.5h: ON — 0.5h: OFF Test time: 1,000 to 1,048 hrs.
Endurance (under load in damp environment)	$\pm (5.0\%+0.1\Omega)$	Max. 100m Ω	JIS C 5202 7.9 Rated voltage (current), 60 $^{\circ}$ C, 95%RH 1.5h: ON — 0.5h: OFF Test time: 1,000 to 1,048 hrs.
Resistance to humidity (steady state)	$\pm (3.0\%+0.1\Omega)$	Max. 100m Ω	JIS C 5202 7.5 85 $^{\circ}$ C, 85%RH Test time: 1,000 to 1,048 hrs.
Temperature cycling	$\pm (1.0\%+0.05\Omega)$	Max. 50m Ω	JIS C 5202 7.4 Test temperature: -55 $^{\circ}$ C to +125 $^{\circ}$ C 100cyc.
Resistance to solvents	$\pm (0.5\%+0.05\Omega)$ Markings must not be dissolved away.	Max. 50m Ω	JIS C 5202 6.9 Room temperature, static immersion, 1 min. Solvent: Isopropyl alcohol

●External dimensions (Units: mm)

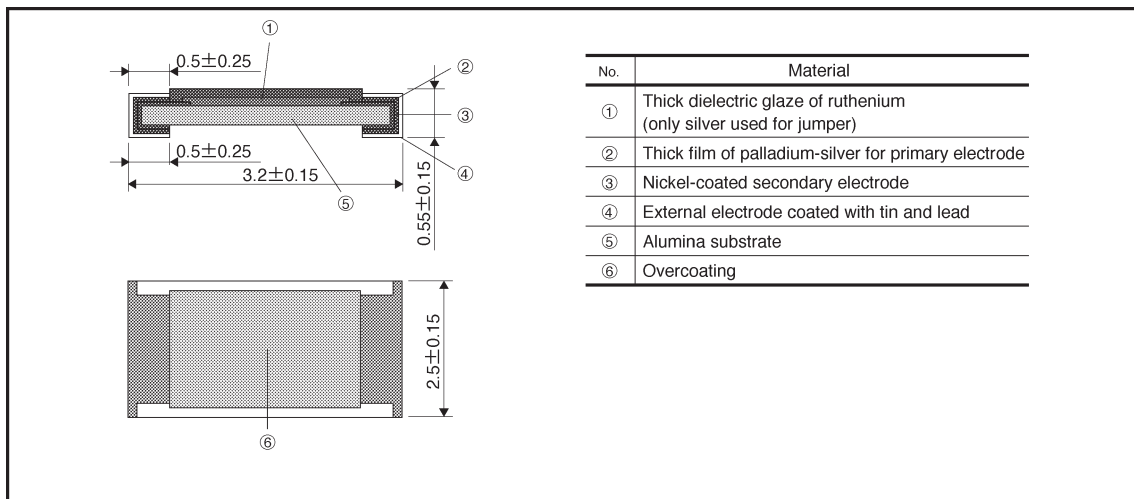

●Packaging

Reel

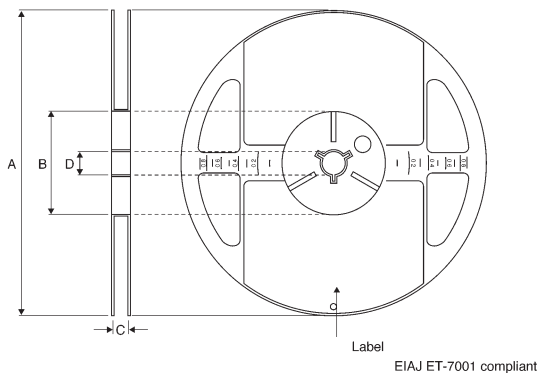

(Units : mm)

A	B	C	D
$\phi 180 \begin{smallmatrix} 0 \\ -3 \end{smallmatrix}$	$\phi 60 \begin{smallmatrix} +1 \\ 0 \end{smallmatrix}$	13 ± 0.3	$\phi 13 \pm 0.2$

Taping

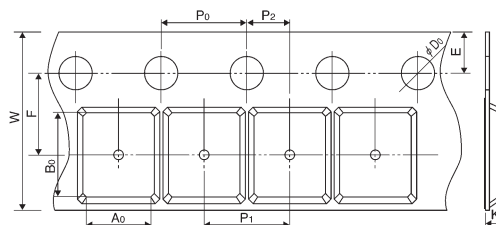

(Units : mm)

W	F	E	A ₀	B ₀
8.0 ± 0.3	3.5 ± 0.05	1.75 ± 0.1	3.0 ± 0.1	3.5 ± 0.1
D ₀	P ₀	P ₁	P ₂	K
$\phi 1.5 \begin{smallmatrix} +0.1 \\ 0 \end{smallmatrix}$	4.0 ± 0.1	4.0 ± 0.1	2.0 ± 0.05	Max. 1.1

●Makeup of the part number

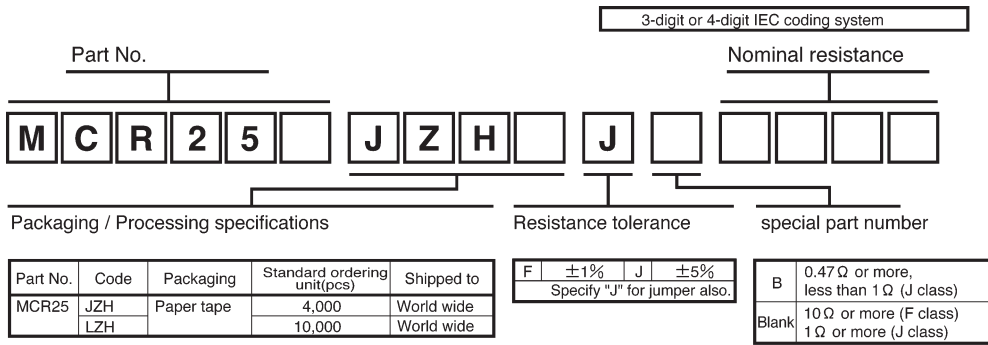

●Dimensions

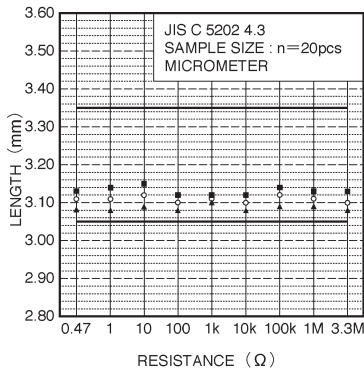

Fig.2 Dimensions (length)

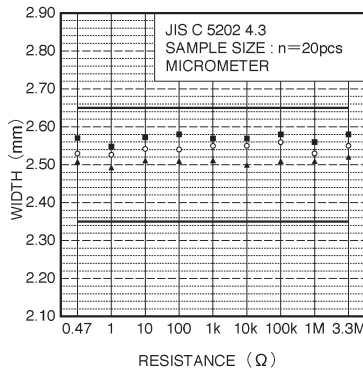

Fig.3 Dimensions (width)

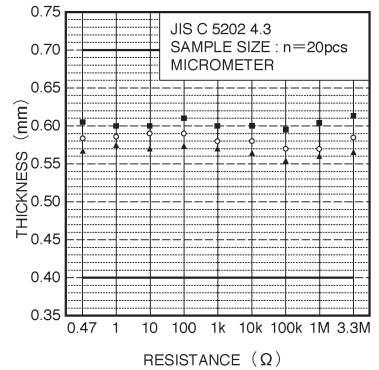

Fig.4 Dimensions (thickness)

●Electrical characteristics

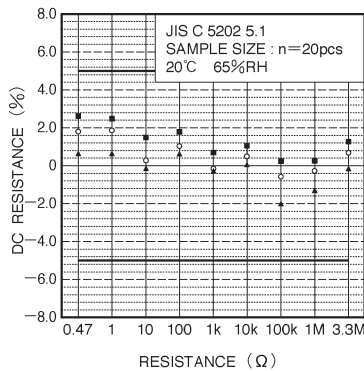

Fig.5 DC resistance

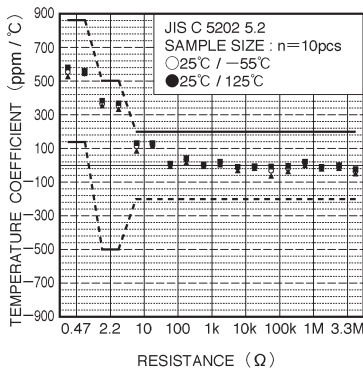

Fig.6 Resistance temperature characteristics

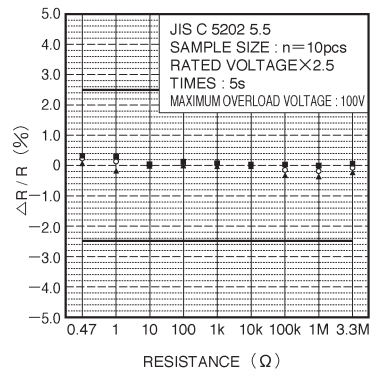

Fig.7 Short time overload

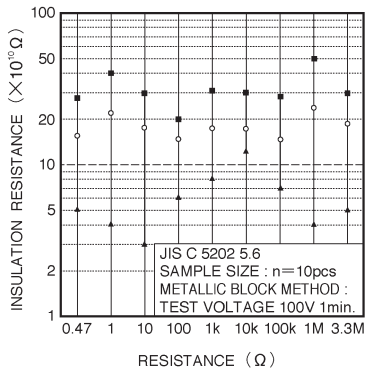

Fig.8 Insulation resistance

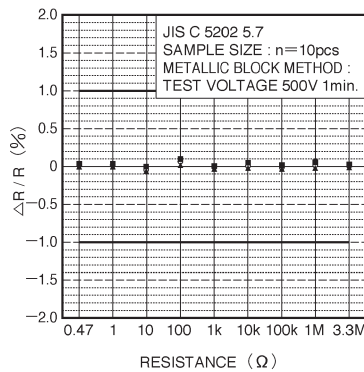

Fig.9 Withstand voltage

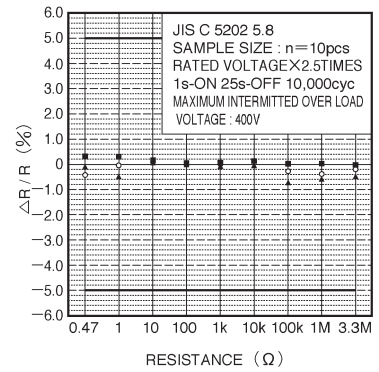

Fig.10 Intermittent overload

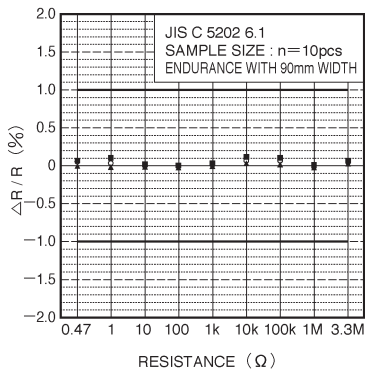

Fig.11 Terminal strength (bending strength characteristics)

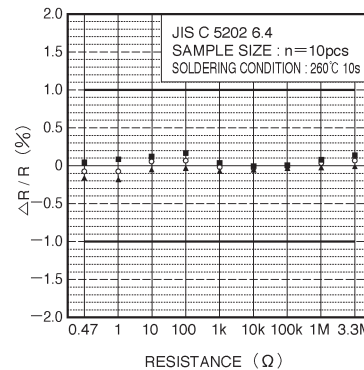

Fig.12 Resistance to soldering heat

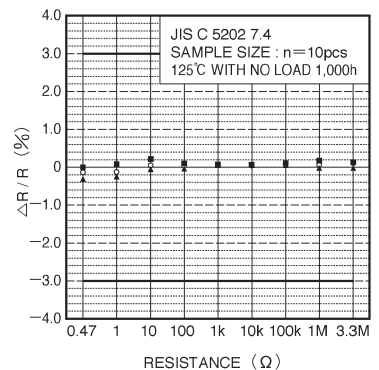

Fig.13 Resistance to dry heat

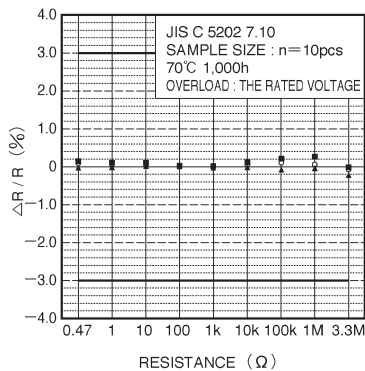

Fig.14 Endurance (rated load)

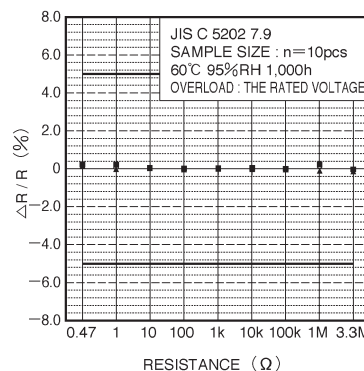

Fig.15 Endurance (under load in damp environment)

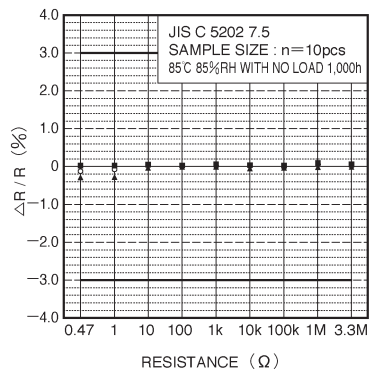

Fig.16 Resistance to humidity (steady state)

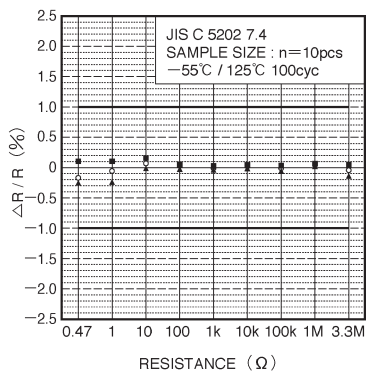

Fig.17 Temperature cycling

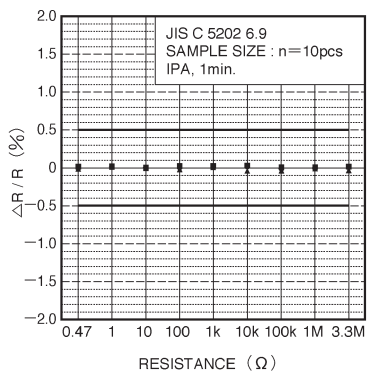

Fig.18 Resistance to solvents