Document Title

1Mx36 & 2Mx18-Bit Synchronous Burst SRAM

Revision History

<u>Rev. No.</u>	<u>History</u>	<u>Draft Date</u>	<u>Remark</u>
0.0	1. Initial draft	May. 10. 2001	Advance
0.1	1. Add 165FBGA package	Aug. 29. 2001	Preliminary
0.2	1. Update JTAG scan order	Dec. 03. 2001	Preliminary
0.3	1. Change pin out for 165FBGA - x18/x36 ; 11B => from A to NC , 2R ==> from NC to A .	Feb. 14 . 2002	Preliminary
0.4	1. Insert pin at JTAG scan order of 165FBGA in connection with pin out change - x18/x36 ; insert Pin ID of 2R to $\overline{\text{BIT}}$ number of 69	Apr. 20. 2002	Preliminary
0.5	1. Add lcc, lsb, lsb1 and lsb2 values.	May. 10. 2002	Preliminary
1.0	1. Correct the pin name of 100TQFP.	Oct. 15. 2002	Final
1.1	1. Change the Stand-by current (lsb) Before After lsb - 65 : 100 140 - 75 : 90 130 - 85 : 80 130 lsb1 : 90 110 lsb2 : 80 100	Oct. 17, 2003	Final
2.0	1. Delete the 119BGA and 165FBGA package. 2. Delete the 8.5ns speed bin	Nov. 18, 2003	Final

The attached data sheets are prepared and approved by SAMSUNG Electronics. SAMSUNG Electronics CO., LTD. reserve the right to change the specifications. SAMSUNG Electronics will evaluate and reply to your requests and questions on the parameters of this device. If you have any questions, please contact the SAMSUNG branch office near your office, call or contact Headquarters.

**K7B323625M
K7B321825M**

1Mx36 & 2Mx18 Synchronous SRAM

32Mb SB/SPB Synchronous SRAM Ordering Information

Org.	Part Number	Mode	VDD	Speed SB ; Access Time(ns) SPB ; Cycle Time(MHz)	PKG	Temp
2Mx18	K7B321825M-QC65/75	SB	3.3	6.5/7.5ns	Q: 100TQFP	C ; Commercial Temp.Range I ; Industrial Temp.Range
	K7A321800M-QC(I)25/20/14	SPB(2E1D)	3.3	250/200/138MHz		
1Mx36	K7B323625M-Q)C65/75	SB	3.3	6.5/7.5ns		
	K7A323600M-QC(I)25/20/14	SPB(2E1D)	3.3	250/200/138MHz		

1Mx36 & 2Mx18-Bit Synchronous Burst SRAM

FEATURES

- Synchronous Operation.
- On-Chip Address Counter.
- Self-Timed Write Cycle.
- On-Chip Address and Control Registers.
- 3.3V+0.165V/-0.165V Power Supply.
- I/O Supply Voltage 3.3V+0.165V/-0.165V for 3.3V I/O or 2.5V+0.4V/-0.125V for 2.5V I/O
- 5V Tolerant Inputs Except I/O Pins.
- Byte Writable Function.
- Global Write Enable Controls a full bus-width write.
- Power Down State via ZZ Signal.
- LBO Pin allows a choice of either a interleaved burst or a linear burst.
- Three Chip Enables for simple depth expansion with No Data Contention only for TQFP.
- Asynchronous Output Enable Control.
- ADSP, ADSC, ADV Burst Control Pins.
- TTL-Level Three-State Output.
- 100-TQFP-1420A Package

GENERAL DESCRIPTION

The K7B323625M and K7B321825M are 37,748,736-bit Synchronous Static Random Access Memory designed for high performance second level cache of Pentium and Power PC based System.

It is organized as 1M(2M) words of 36(18) bits and integrates address and control registers, a 2-bit burst address counter and added some new functions for high performance cache RAM applications; \overline{GW} , \overline{BW} , \overline{LBO} , ZZ. Write cycles are internally self-timed and synchronous.

Full bus-width write is done by \overline{GW} , and each byte write is performed by the combination of \overline{WEx} and \overline{BW} when \overline{GW} is high. And with $\overline{CS1}$ high, \overline{ADSP} is blocked to control signals.

Burst cycle can be initiated with either the address status processor(ADSP) or address status cache controller(ADSC) inputs. Subsequent burst addresses are generated internally in the system's burst sequence and are controlled by the burst address advance(ADV) input.

\overline{LBO} pin is DC operated and determines burst sequence(linear or interleaved).

ZZ pin controls Power Down State and reduces Stand-by current regardless of CLK.

The K7B323625M and K7B321825M are fabricated using SAMSUNG's high performance CMOS technology and is available in a 100pin TQFP package. Multiple power and ground pins are utilized to minimize ground bounce.

FAST ACCESS TIMES

PARAMETER	Symbol	-65	-75	Unit
Cycle Time	t _{CYC}	7.5	8.5	ns
Clock Access Time	t _{CD}	6.5	7.5	ns
Output Enable Access Time	t _{OE}	3.5	3.5	ns

LOGIC BLOCK DIAGRAM

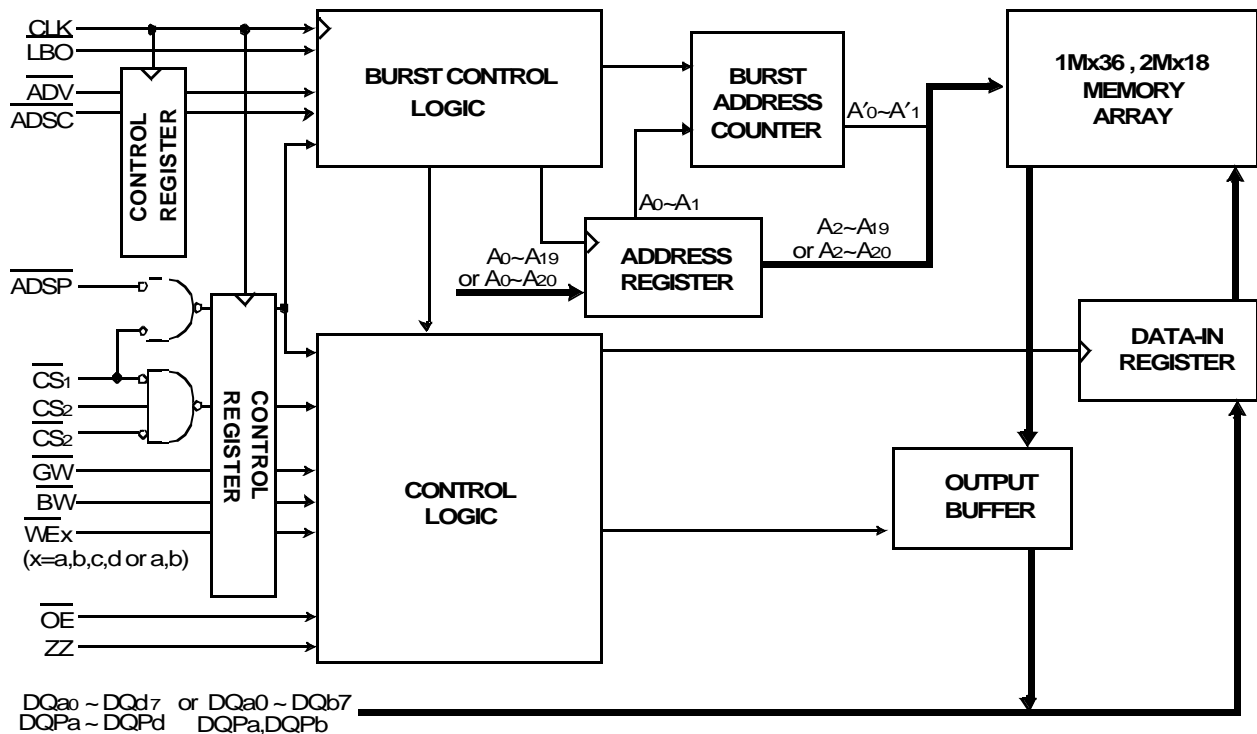

DQa0 ~ DQd7 or DQa0 ~ DQb7
DQPa ~ DQPd DQPa, DQPb

**K7B323625M
K7B321825M**

1Mx36 & 2Mx18 Synchronous SRAM

PIN CONFIGURATION(TOP VIEW)

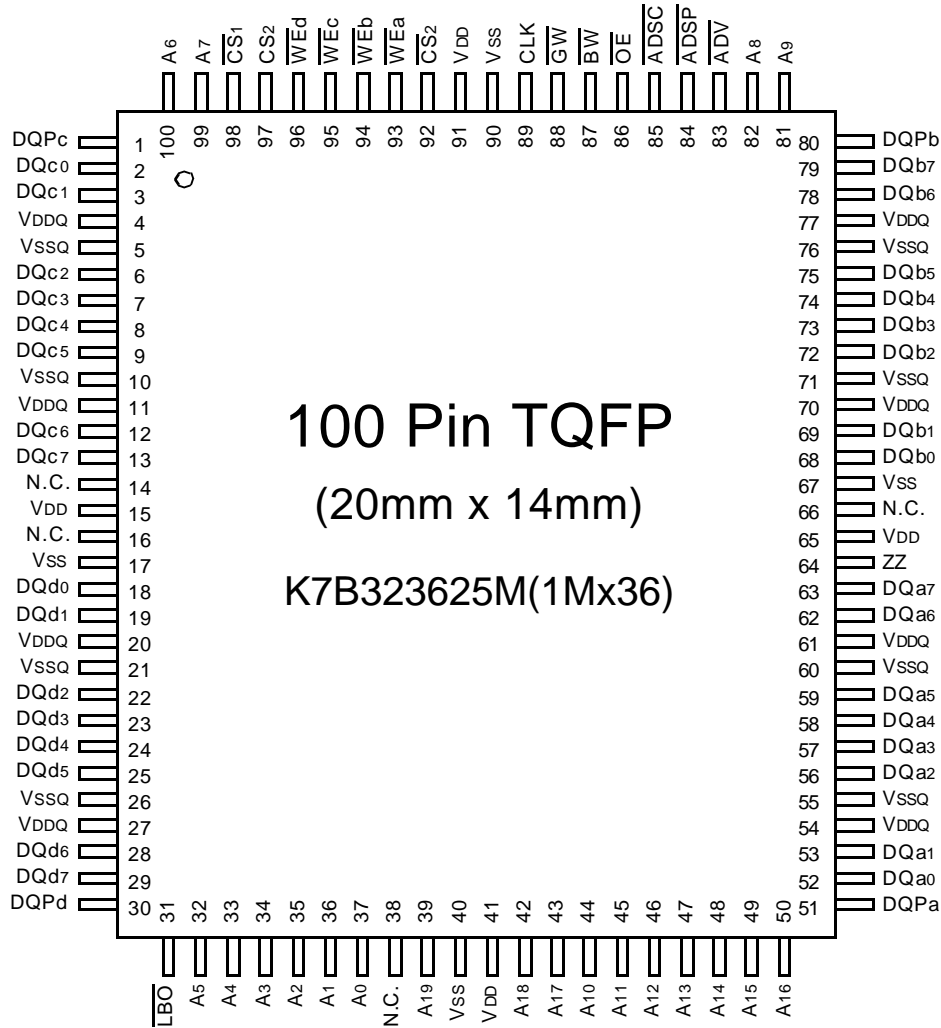

PIN NAME

SYMBOL	PIN NAME	TQFP PIN NO.	SYMBOL	PIN NAME	TQFP PIN NO.
A0 - A19	Address Inputs	32,33,34,35,36,37,39 42,43,44,45,46,47,48, 49,50,81,82,99,100	VDD	Power Supply(+3.3V)	15,41,65,91
			VSS	Ground	17,40,67,90
<u>ADV</u>	Burst Address Advance	83	N.C.	No Connect	14,16,38,66
<u>ADSP</u>	Address Status Processor	84	DQa0~a7	Data Inputs/Outputs	52,53,56,57,58,59,62,63
<u>ADSC</u>	Address Status Controller	85	DQb0~b7		68,69,72,73,74,75,78,79
<u>CLK</u>	Clock	89	DQc0~c7		2,3,6,7,8,9,12,13
<u>CS1</u>	Chip Select	98	DQd0~d7		18,19,22,23,24,25,28,29
<u>CS2</u>	Chip Select	97	DQPa~Pd		51,80,1,30
<u>CS2</u>	Chip Select	92			
<u>WE_x(x=a,b,c,d)</u>	Byte Write Inputs	93,94,95,96	VDDQ	Output Power Supply (2.5V or 3.3V)	4,11,20,27,54,61,70,77
<u>OE</u>	Output Enable	86	VSSQ	Output Ground	5,10,21,26,55,60,71,76
<u>GW</u>	Global Write Enable	88			
<u>BW</u>	Byte Write Enable	87			
<u>ZZ</u>	Power Down Input	64			
<u>LBO</u>	Burst Mode Control	31			

Notes : 1. A₀ and A₁ are the two least significant bits(LSB) of the address field and set the internal burst counter if burst is desired.

**K7B323625M
K7B321825M**

1Mx36 & 2Mx18 Synchronous SRAM

PIN CONFIGURATION(TOP VIEW)

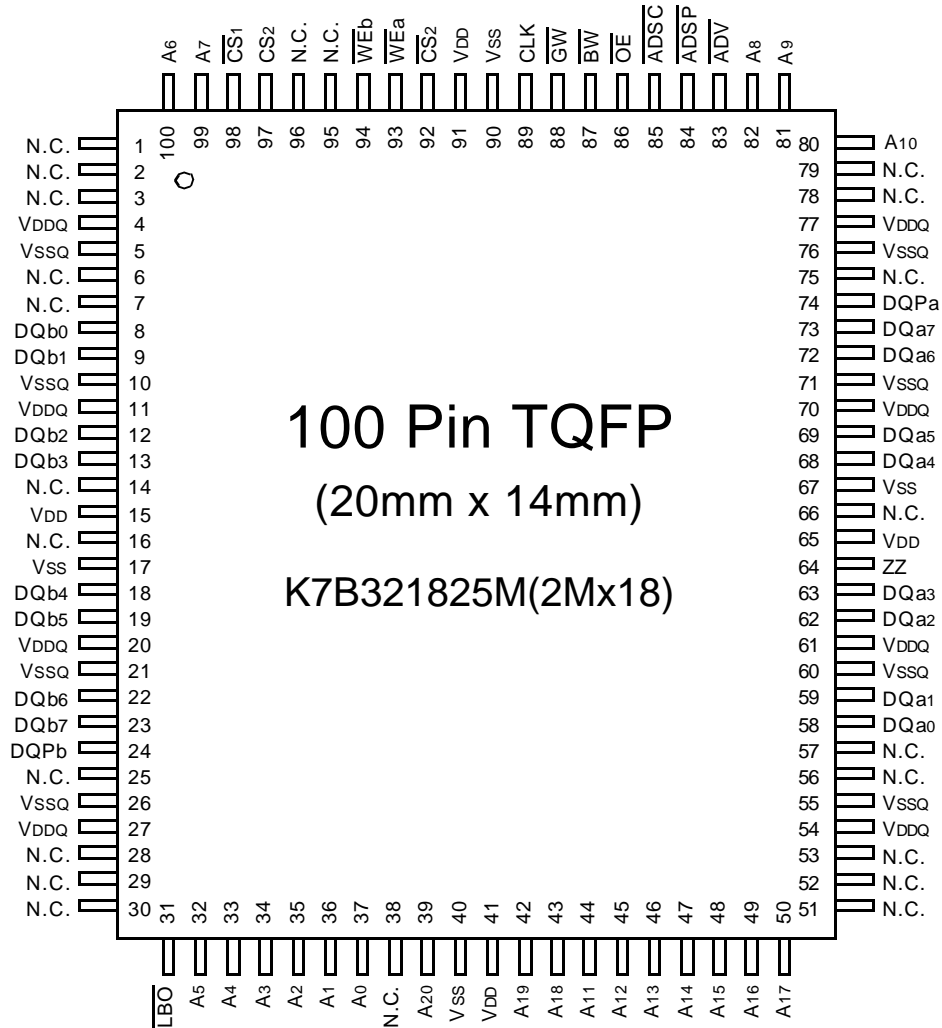

PIN NAME

SYMBOL	PIN NAME	TQFP PIN NO.	SYMBOL	PIN NAME	TQFP PIN NO.
A0 - A20	Address Inputs	32,33,34,35,36,37,39 42,43,44,45,46,47,48, 49,50 80,81,82,99,100	VDD	Power Supply(+3.3V)	15,41,65,91
			Vss	Ground	17,40,67,90
			N.C.	No Connect	1,2,3,6,7,14,16,25,28,29, 30,38,51,52,53,56,57,66, 75,78,79,95,96
\overline{ADV}	Burst Address Advance	83	DQa0 ~ a7	Data Inputs/Outputs	58,59,62,63,68,69,72,73
\overline{ADSP}	Address Status Processor	84	DQb0 ~ b7		8,9,12,13,18,19,22,23
\overline{ADSC}	Address Status Controller	85	DQPa, Pb		74,24
CLK	Clock	89	VDDQ	Output Power Supply (2.5V or 3.3V)	4,11,20,27,54,61,70,77
$\overline{CS1}$	Chip Select	98	VSSQ	Output Ground	5,10,21,26,55,60,71,76
$\overline{CS2}$	Chip Select	97			
$\overline{CS2}$	Chip Select	92			
$\overline{WEx(x=a,b)}$	Byte Write Inputs	93,94			
\overline{OE}	Output Enable	86			
\overline{GW}	Global Write Enable	88			
\overline{BW}	Byte Write Enable	87			
\overline{ZZ}	Power Down Input	64			
\overline{LBO}	Burst Mode Control	31			

Notes : 1. A₀ and A₁ are the two least significant bits(LSB) of the address field and set the internal burst counter if burst is desired.

FUNCTION DESCRIPTION

The K7B323625M and K7B321825M are synchronous SRAM designed to support the burst address accessing sequence of the Power PC based microprocessor. All inputs (with the exception of \overline{OE} , \overline{LBO} and \overline{ZZ}) are sampled on rising clock edges. The start and duration of the burst access is controlled by \overline{ADSC} , \overline{ADSP} and \overline{ADV} and chip select pins.

The accesses are enabled with the chip select signals and output enabled signals. Wait states are inserted into the access with \overline{ADV} .

When \overline{ZZ} is pulled high, the SRAM will enter a Power Down State. At this time, internal state of the SRAM is preserved. When \overline{ZZ} returns to low, the SRAM normally operates after 2cycles of wake up time. \overline{ZZ} pin is pulled down internally.

Read cycles are initiated with \overline{ADSP} (or \overline{ADSC}) using the new external address clocked into the on-chip address register when both \overline{GW} and \overline{BW} are high or when \overline{BW} is low and \overline{WEa} , \overline{WEb} , \overline{WEc} , and \overline{WEd} are high. When \overline{ADSP} is sampled low, the chip selects are sampled active, and the output buffer is enabled with \overline{OE} . the data of cell array accessed by the current address are projected to the output pins.

Write cycles are also initiated with \overline{ADSP} (or \overline{ADSC}) and are differentiated into two kinds of operations; All byte write operation and individual byte write operation.

All byte write occurs by enabling \overline{GW} (independent of \overline{BW} and \overline{WEx}), and individual byte write is performed only when \overline{GW} is high and \overline{BW} is low. In K7B163625M, a 512Kx36 organization, \overline{WEa} controls DQa0 ~ DQa7 and DQPa, \overline{WEb} controls DQb0 ~ DQb7 and DQPb, \overline{WEc} controls DQc0 ~ DQc7 and DQPc and \overline{WEd} controls DQd0 ~ DQd7 and DQPd.

$\overline{CS1}$ is used to enable the device and conditions internal use of \overline{ADSP} and is sampled only when a new external address is loaded.

\overline{ADV} is ignored at the clock edge when \overline{ADSP} is asserted, but can be sampled on the subsequent clock edges. The address increases internally for the next access of the burst when \overline{ADV} is sampled low.

Addresses are generated for the burst access as shown below, The starting point of the burst sequence is provided by the external address. The burst address counter wraps around to its initial state upon completion. The burst sequence is determined by the state of the \overline{LBO} pin. When this pin is Low, linear burst sequence is selected. And this pin is High, Interleaved burst sequence is selected.

BURST SEQUENCE TABLE

(Interleaved Burst)

\overline{LBO} PIN	HIGH	Case 1		Case 2		Case 3		Case 4	
		A1	A0	A1	A0	A1	A0	A1	A0
	First Address	0	0	0	1	1	0	1	1
	↓	0	1	0	0	1	1	1	0
	↓	1	0	1	1	0	0	0	1
	Fourth Address	1	1	1	0	0	1	0	0

(Linear Burst)

\overline{LBO} PIN	LOW	Case 1		Case 2		Case 3		Case 4	
		A1	A0	A1	A0	A1	A0	A1	A0
	First Address	0	0	0	1	1	0	1	1
	↓	0	1	1	0	1	1	0	0
	↓	1	0	1	1	0	0	0	1
	Fourth Address	1	1	0	0	0	1	1	0

Note : 1. \overline{LBO} pin must be tied to High or Low, and Floating State must not be allowed.

TRUTH TABLES

SYNCHRONOUS TRUTH TABLE

CS ₁	CS ₂	CS ₂	ADSP	ADSC	ADV	WRITE	CLK	ADDRESS ACCESSED	OPERATION
H	X	X	X	L	X	X	↑	N/A	Not Selected
L	L	X	L	X	X	X	↑	N/A	Not Selected
L	X	H	L	X	X	X	↑	N/A	Not Selected
L	L	X	X	L	X	X	↑	N/A	Not Selected
L	X	H	X	L	X	X	↑	N/A	Not Selected
L	H	L	L	X	X	X	↑	External Address	Begin Burst Read Cycle
L	H	L	H	L	X	L	↑	External Address	Begin Burst Write Cycle
L	H	L	H	L	X	H	↑	External Address	Begin Burst Read Cycle
X	X	X	H	H	L	H	↑	Next Address	Continue Burst Read Cycle
H	X	X	X	H	L	H	↑	Next Address	Continue Burst Read Cycle
X	X	X	H	H	L	L	↑	Next Address	Continue Burst Write Cycle
H	X	X	X	H	L	L	↑	Next Address	Continue Burst Write Cycle
X	X	X	H	H	H	H	↑	Current Address	Suspend Burst Read Cycle
H	X	X	X	H	H	H	↑	Current Address	Suspend Burst Read Cycle
X	X	X	H	H	H	L	↑	Current Address	Suspend Burst Write Cycle
H	X	X	X	H	H	L	↑	Current Address	Suspend Burst Write Cycle

- Notes :** 1. X means "Don't Care". 2. The rising edge of clock is symbolized by ↑.
 3. $\overline{\text{WRITE}} = \text{L}$ means Write operation in WRITE TRUTH TABLE.
 $\overline{\text{WRITE}} = \text{H}$ means Read operation in WRITE TRUTH TABLE.
 4. Operation finally depends on status of asynchronous input pins(ZZ and $\overline{\text{OE}}$).

WRITE TRUTH TABLE(x36)

$\overline{\text{GW}}$	$\overline{\text{BW}}$	$\overline{\text{WEa}}$	$\overline{\text{WEb}}$	$\overline{\text{WEc}}$	$\overline{\text{WEd}}$	OPERATION
H	H	X	X	X	X	READ
H	L	H	H	H	H	READ
H	L	L	H	H	H	WRITE BYTE a
H	L	H	L	H	H	WRITE BYTE b
H	L	H	H	L	L	WRITE BYTE c and d
H	L	L	L	L	L	WRITE ALL BYTES
L	X	X	X	X	X	WRITE ALL BYTES

- Notes :** 1. X means "Don't Care".
 2. All inputs in this table must meet setup and hold time around the rising edge of CLK(↑).

WRITE TRUTH TABLE(x18)

$\overline{\text{GW}}$	$\overline{\text{BW}}$	$\overline{\text{WEa}}$	$\overline{\text{WEb}}$	OPERATION
H	H	X	X	READ
H	L	H	H	READ
H	L	L	H	WRITE BYTE a
H	L	H	L	WRITE BYTE b
H	L	L	L	WRITE ALL BYTES
L	X	X	X	WRITE ALL BYTES

- Notes :** 1. X means "Don't Care".
 2. All inputs in this table must meet setup and hold time around the rising edge of CLK(↑).

ASYNCHRONOUS TRUTH TABLE

Operation	ZZ	\overline{OE}	I/O STATUS
Sleep Mode	H	X	High-Z
Read	L	L	DQ
	L	H	High-Z
Write	L	X	Din, High-Z
Deselected	L	X	High-Z

Notes

1. X means "Don't Care".
2. ZZ pin is pulled down internally
3. For write cycles that following read cycles, the output buffers must be disabled with \overline{OE} , otherwise data bus contention will occur.
4. Sleep Mode means power down state of which stand-by current does not depend on cycle time.
5. Deselected means power down state of which stand-by current depends on cycle time.

ABSOLUTE MAXIMUM RATINGS*

PARAMETER	SYMBOL	RATING	UNIT
Voltage on VDD Supply Relative to VSS	VDD	-0.3 to 4.6	V
Voltage on VDDQ Supply Relative to VSS	VDDQ	VDD	V
Voltage on Input Pin Relative to VSS	VIN	-0.3 to VDD+0.3	V
Voltage on I/O Pin Relative to VSS	VIO	-0.3 to VDDQ+0.3	V
Power Dissipation	PD	1.6	W
Storage Temperature	TSTG	-65 to 150	°C
Operating Temperature	TOPR	0 to 70	°C
Storage Temperature Range Under Bias	TBIAS	-10 to 85	°C

*Notes : Stresses greater than those listed under "Absolute Maximum Ratings" may cause permanent damage to the device. This is a stress rating only and functional operation of the device at these or any other conditions above those indicated in the operating sections of this specification is not implied. Exposure to absolute maximum rating conditions for extended periods may affect reliability.

OPERATING CONDITIONS at 3.3V I/O (0°C ≤ TA ≤ 70°C)

PARAMETER	SYMBOL	MIN	Typ.	MAX	UNIT
Supply Voltage	VDD	3.135	3.3	3.465	V
	VDDQ	3.135	3.3	3.465	V
Ground	VSS	0	0	0	V

OPERATING CONDITIONS at 2.5V I/O (0°C ≤ TA ≤ 70°C)

PARAMETER	SYMBOL	MIN	Typ.	MAX	UNIT
Supply Voltage	VDD	3.135	3.3	3.465	V
	VDDQ	2.375	2.5	2.9	V
Ground	VSS	0	0	0	V

CAPACITANCE* (TA=25°C, f=1MHz)

PARAMETER	SYMBOL	TEST CONDITION	MIN	MAX	UNIT
Input Capacitance	CIN	VIN=0V	-	5	pF
Output Capacitance	COUT	VOUT=0V	-	7	pF

*Note : Sampled not 100% tested.

DC ELECTRICAL CHARACTERISTICS ($V_{DD}=3.3V+0.165V/-0.165V$, $T_A=0^{\circ}C$ to $+70^{\circ}C$)

Parameter	Symbol	Test Conditions	Min	Max	Unit	Notes	
Input Leakage Current(except ZZ)	IIL	$V_{DD}=\text{Max}$; $V_{IN}=V_{SS}$ to V_{DD}	-2	+2	μA		
Output Leakage Current	IOL	Output Disabled, $V_{out}=V_{SS}$ to V_{DDQ}	-2	+2	μA		
Operating Current	ICC	Device Selected, $I_{OUT}=0mA$, $ZZ \leq V_{IL}$, Cycle Time $\geq t_{CYC}$ Min	-65	-	310	mA	1,2
			-75	-	290		
Standby Current	ISB	Device deselected, $I_{OUT}=0mA$, $ZZ \leq V_{IL}$, $f=\text{Max}$, All Inputs $\leq 0.2V$ or $\geq V_{DD}-0.2V$	-65	-	140	mA	
			-75	-	130		
	ISB1	Device deselected, $I_{OUT}=0mA$, $ZZ \leq 0.2V$, $f=0$, All Inputs=fixed ($V_{DD}-0.2V$ or		-	110	mA	
	ISB2	Device deselected, $I_{OUT}=0mA$, $ZZ \geq V_{DD}-0.2V$, $f=\text{Max}$, All Inputs $\leq V_{IL}$ or $\geq V_{IH}$		-	100		
Output Low Voltage(3.3V I/O)	VOL	$I_{OL}=8.0mA$	-	0.4	V		
Output High Voltage(3.3V I/O)	VOH	$I_{OH}=-4.0mA$	2.4	-	V		
Output Low Voltage(2.5V I/O)	VOL	$I_{OL}=1.0mA$	-	0.4	V		
Output High Voltage(2.5V I/O)	VOH	$I_{OH}=-1.0mA$	2.0	-	V		
Input Low Voltage(3.3V I/O)	VIL		-0.3*	0.8	V		
Input High Voltage(3.3V I/O)	VIH		2.0	$V_{DD}+0.3^{**}$	V	3	
Input Low Voltage(2.5V I/O)	VIL		-0.3*	0.7	V		
Input High Voltage(2.5V I/O)	VIH		1.7	$V_{DD}+0.3^{**}$	V	3	

Notes : 1. Reference AC Operating Conditions and Characteristics for input and timing.
 2. Data states are all zero.
 3. In Case of I/O Pins, the Max. $V_{IH}=V_{DDQ}+0.3V$

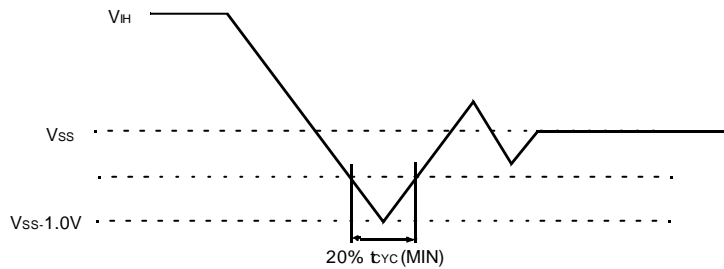

TEST CONDITIONS

($V_{DD}=3.3V+0.165V/-0.165V$, $V_{DDQ}=3.3V+0.165V/-0.165V$ or $V_{DD}=3.3V+0.165V/-0.165V$, $V_{DDQ}=2.5V+0.4V/-0.125V$, $T_A=0$ to $70^{\circ}C$)

PARAMETER	VALUE
Input Pulse Level(for 3.3V I/O)	0 to 3.0V
Input Pulse Level(for 2.5V I/O)	0 to 2.5V
Input Rise and Fall Time(Measured at 20% to 80% for 3.3V I/O)	1.0V/ns
Input Rise and Fall Time(Measured at 20% to 80% for 2.5V I/O)	1.0V/ns
Input and Output Timing Reference Levels for 3.3V I/O	1.5V
Input and Output Timing Reference Levels for 2.5V I/O	$V_{DDQ}/2$
Output Load	See Fig. 1

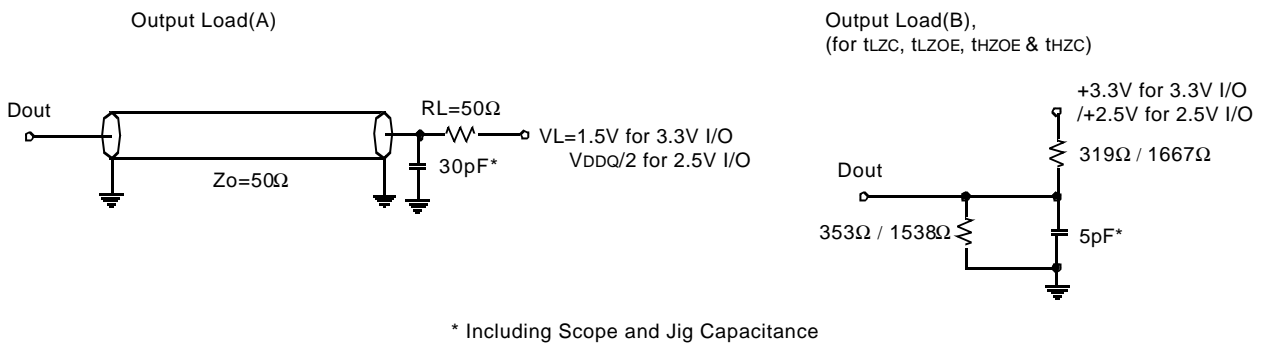

Fig. 1

AC TIMING CHARACTERISTICS($V_{DD}=3.3V+0.165V/-0.165V$, $T_A=0^{\circ}C$ to $+70^{\circ}C$)

PARAMETER	SYMBOL	-65		-75		UNIT
		MIN	MAX	MIN	MAX	
Cycle Time	tCYC	7.5	-	8.5	-	ns
Clock Access Time	tCD	-	6.5	-	7.5	ns
Output Enable to Data Valid	tOE	-	3.5	-	3.5	ns
Clock High to Output Low-Z	tLZC	2.5	-	2.5	-	ns
Output Hold from Clock High	tOH	2.5	-	2.5	-	ns
Output Enable Low to Output Low-Z	tLZOE	0	-	0	-	ns
Output Enable High to Output High-Z	tHZOE	-	3.5	-	3.5	ns
Clock High to Output High-Z	tHZC	-	3.8	-	4.0	ns
Clock High Pulse Width	tCH	2.2	-	2.5	-	ns
Clock Low Pulse Width	tCL	2.2	-	2.5	-	ns
Address Setup to Clock High	tAS	1.5	-	2.0	-	ns
Address Status Setup to Clock High	tSS	1.5	-	2.0	-	ns
Data Setup to Clock High	tDS	1.5	-	2.0	-	ns
Write Setup to Clock High (\overline{GW} , \overline{BW} , \overline{WEx})	tWS	1.5	-	2.0	-	ns
Address Advance Setup to Clock High	tADVS	1.5	-	2.0	-	ns
Chip Select Setup to Clock High	tCSS	1.5	-	2.0	-	ns
Address Hold from Clock High	tAH	0.5	-	0.5	-	ns
Address Status Hold from Clock High	tSH	0.5	-	0.5	-	ns
Data Hold from Clock High	tDH	0.5	-	0.5	-	ns
Write Hold from Clock High (\overline{GW} , \overline{BW} , \overline{WEx})	tWH	0.5	-	0.5	-	ns
Address Advance Hold from Clock High	tADVH	0.5	-	0.5	-	ns
Chip Select Hold from Clock High	tCSH	0.5	-	0.5	-	ns
ZZ High to Power Down	tPDS	2	-	2	-	cycle
ZZ Low to Power Up	tPUS	2	-	2	-	cycle

- Notes :**
1. All address inputs must meet the specified setup and hold times for all rising clock edges whenever \overline{ADSC} and/or \overline{ADSP} is sampled low and \overline{CS} is sampled low. All other synchronous inputs must meet the specified setup and hold times whenever this device is chip selected.
 2. Both chip selects must be active whenever \overline{ADSC} or \overline{ADSP} is sampled low in order for the this device to remain enabled.
 3. \overline{ADSC} or \overline{ADSP} must not be asserted for at least 2 Clock after leaving ZZ state.

TIMING WAVEFORM OF READ CYCLE

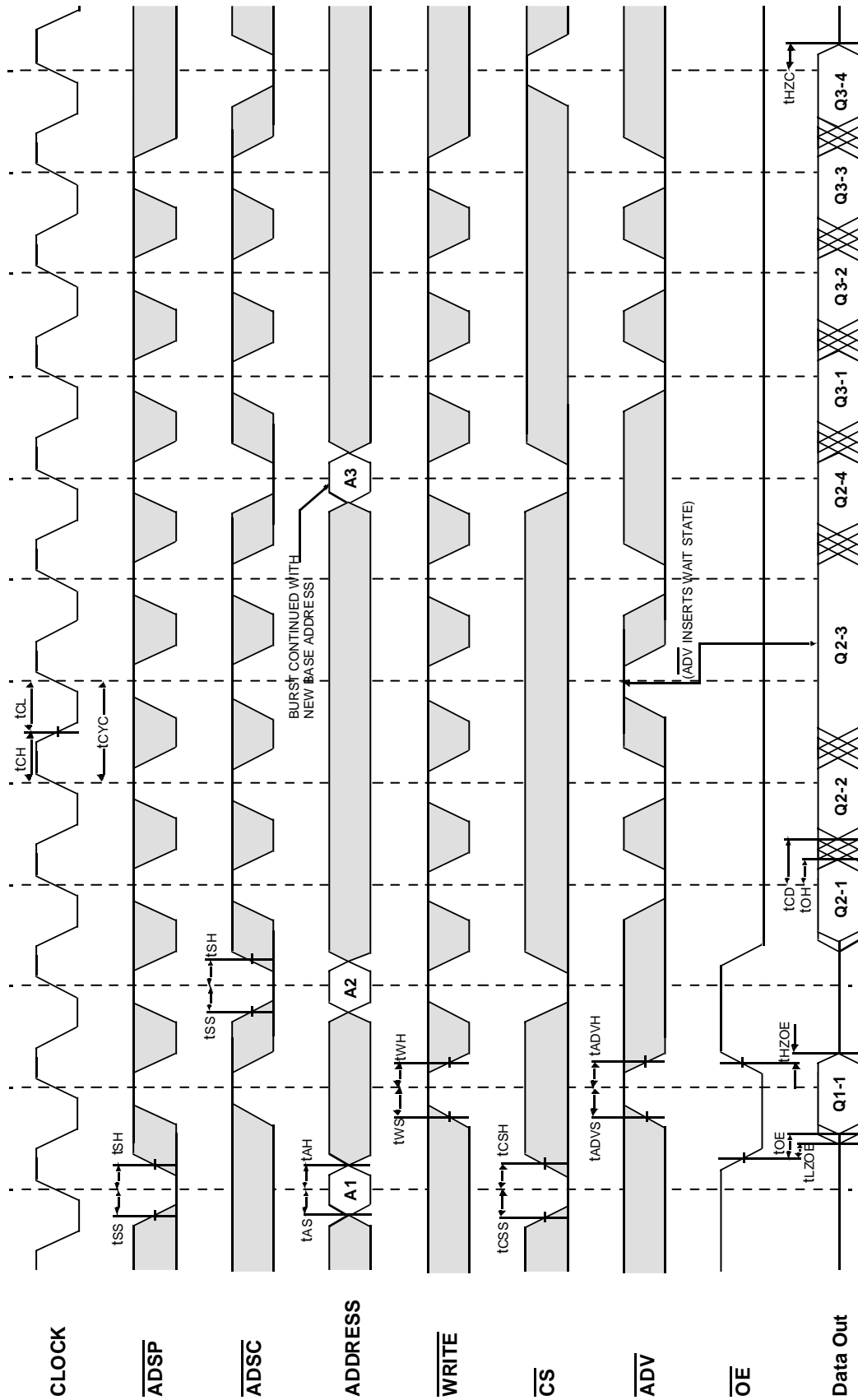

□ Don't Care
⊠ Undefined

NOTES : $\overline{WRITE} = L$ means $\overline{GW} = L$, or $\overline{GW} = H$, $\overline{BW} = L$, $\overline{WE} = L$
 $\overline{CS} = L$ means $\overline{CS}_1 = L$, $\overline{CS}_2 = H$ and $\overline{CS}_2 = L$
 $\overline{CS} = H$ means $\overline{CS}_1 = H$, or $\overline{CS}_1 = L$ and $\overline{CS}_2 = H$, or $\overline{CS}_1 = L$, and $\overline{CS}_2 = L$

TIMING WAVEFORM OF WRTE CYCLE

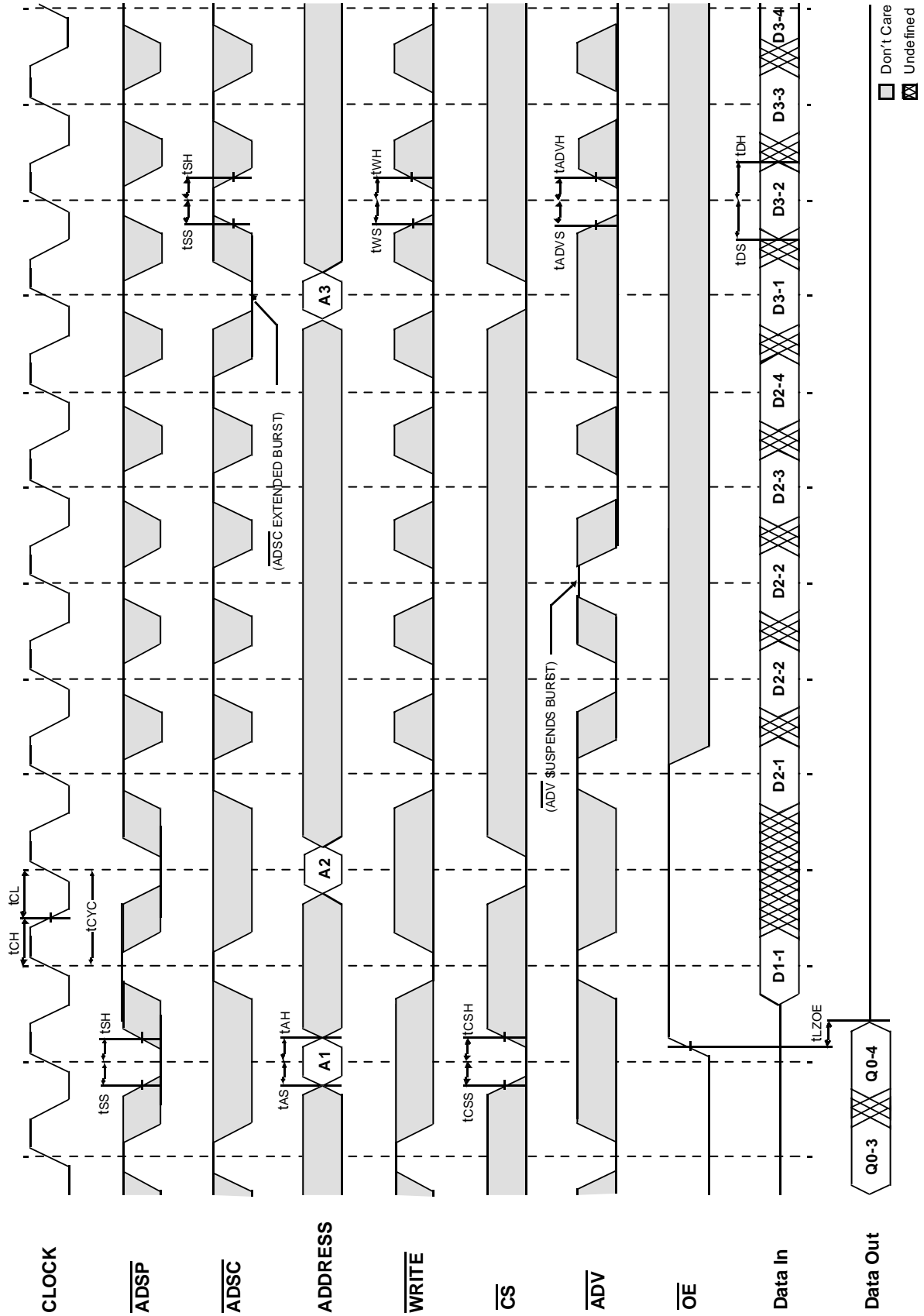

TIMING WAVEFORM OF COMBINATION READ/WRITE CYCLE(ADSP CONTROLLED, $\overline{\text{ADSC}}=\text{HIGH}$)

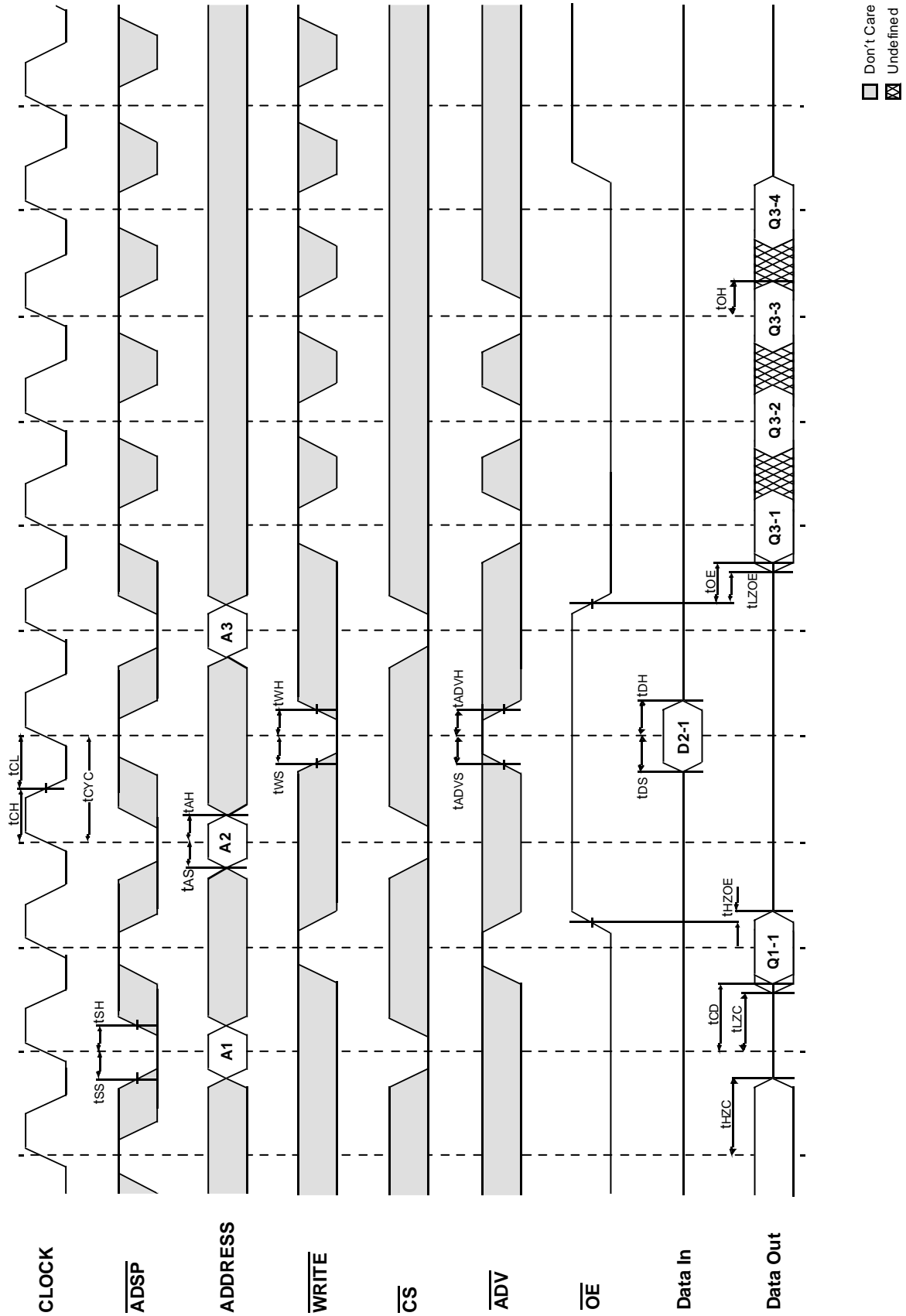

TIMING WAVEFORM OF SINGLE READ/WRITE CYCLE(ADSC CONTROLLED, $\overline{\text{ADSP}}=\text{HIGH}$)

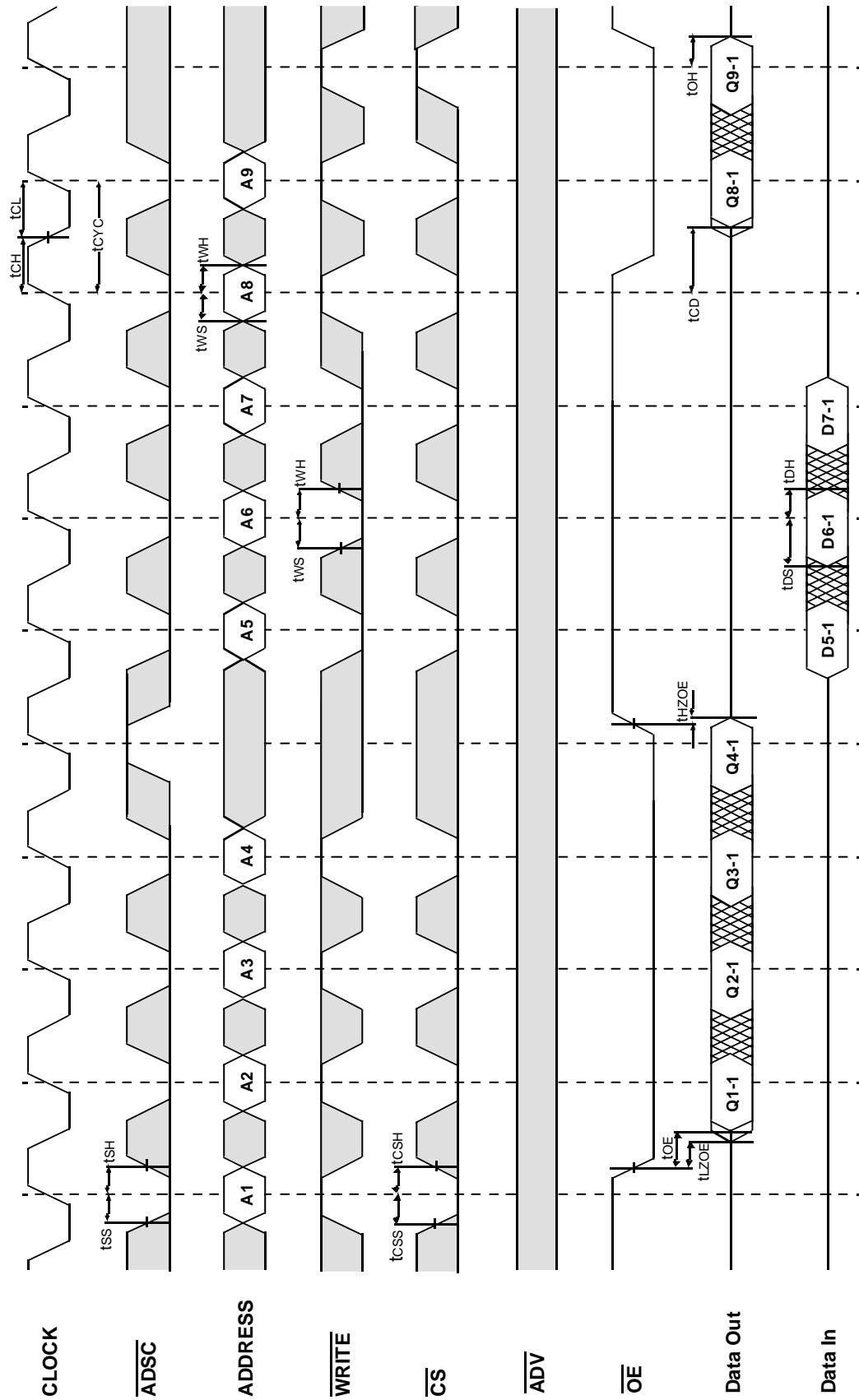

□ Don't Care
▣ Undefined

TIMING WAVEFORM OF SINGLE READ/WRITE CYCLE(ADSP CONTROLLED, $\overline{\text{ADSC}}=\text{HIGH}$)

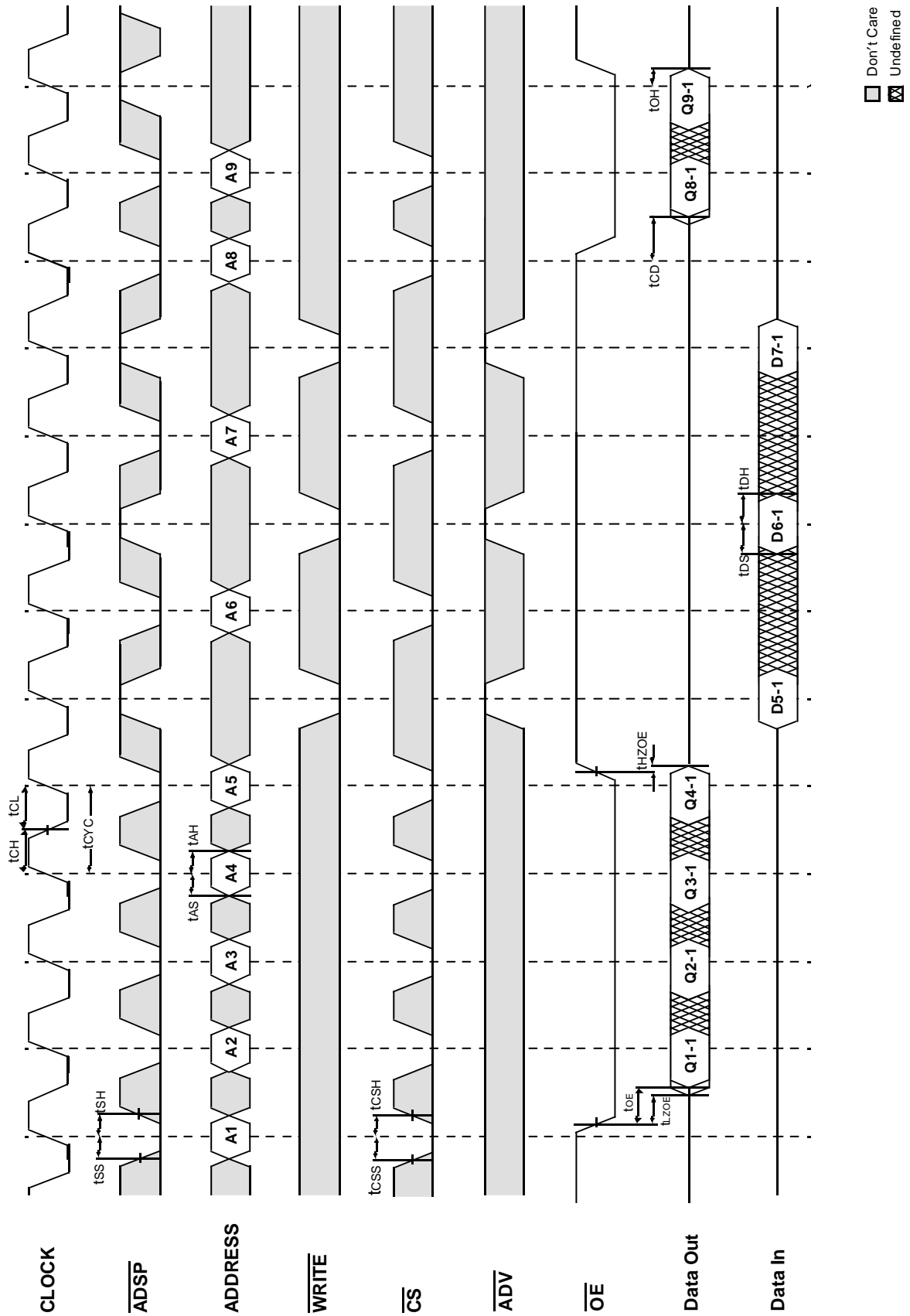

TIMING WAVEFORM OF POWER DOWN CYCLE

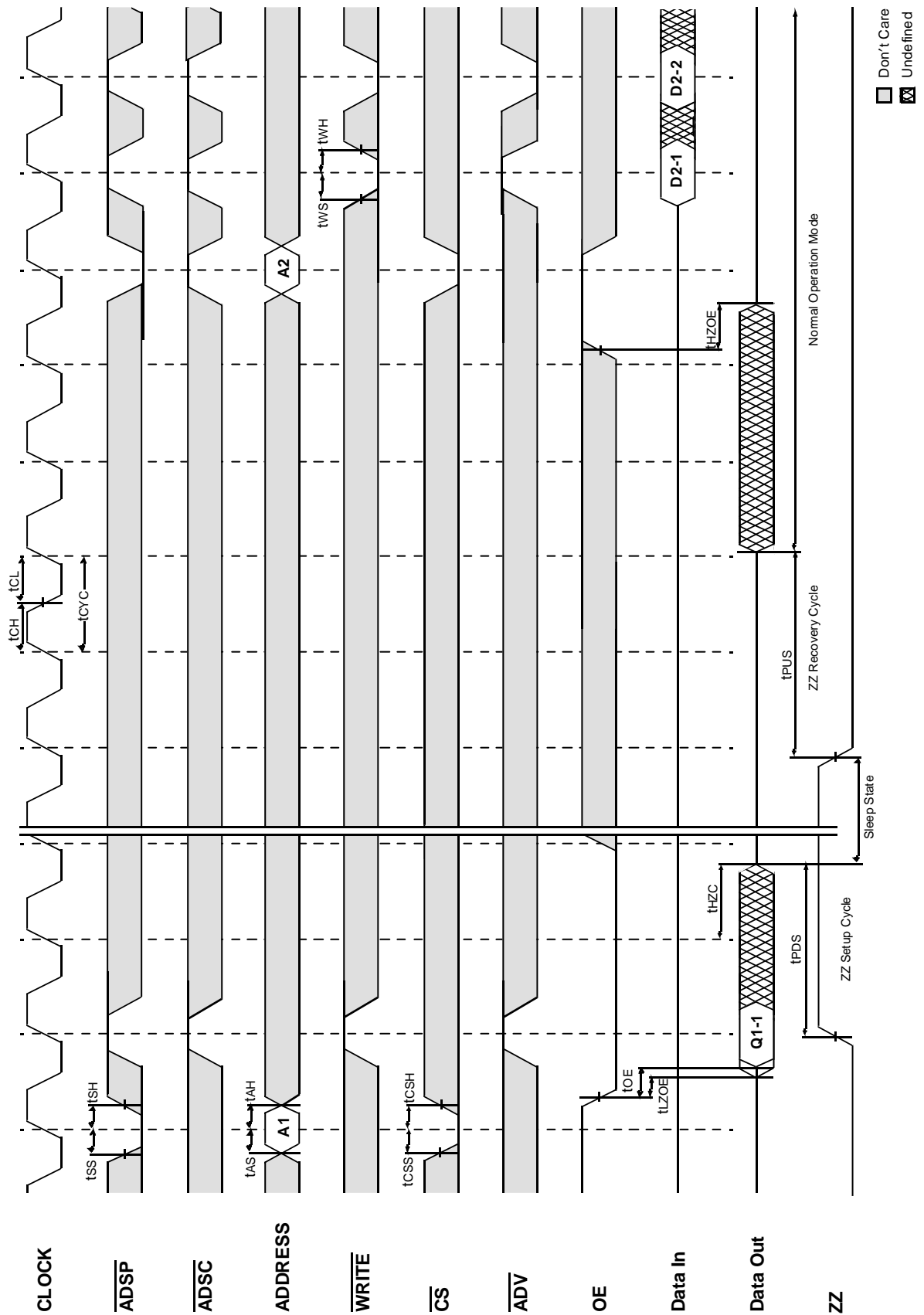

APPLICATION INFORMATION

DEPTH EXPANSION

The Samsung 1Mx36 Synchronous Burst SRAM has two additional chip selects for simple depth expansion. This permits easy secondary cache upgrades from 1M depth to 2M depth without extra logic.

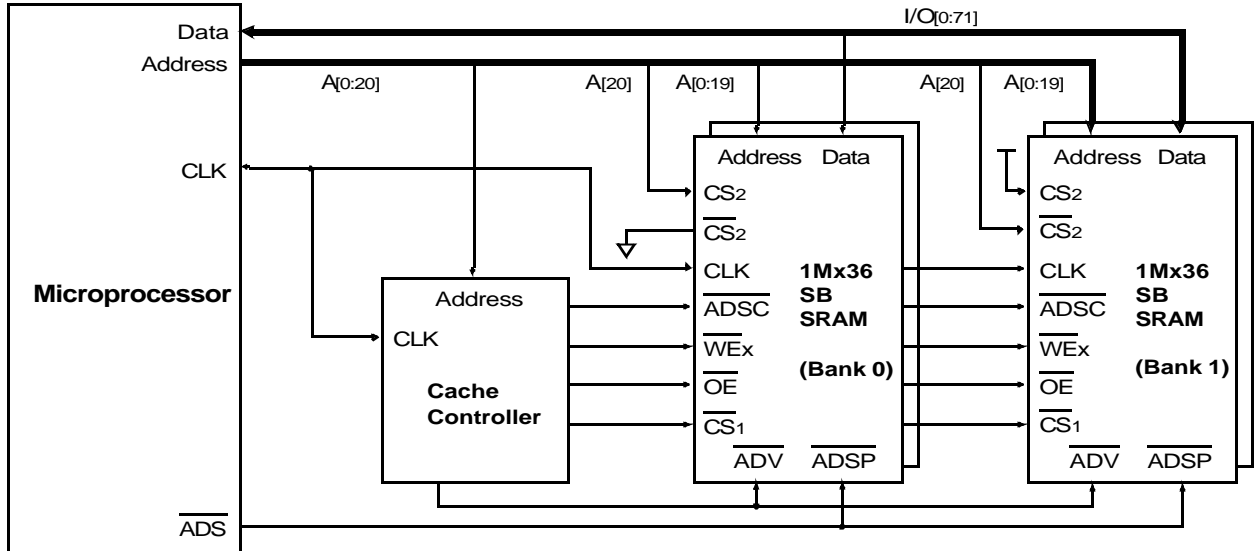

INTERLEAVE READ TIMING (Refer to non-interleave write timing for interleave write timing)

(ADSP CONTROLLED , ADSC=HIGH)

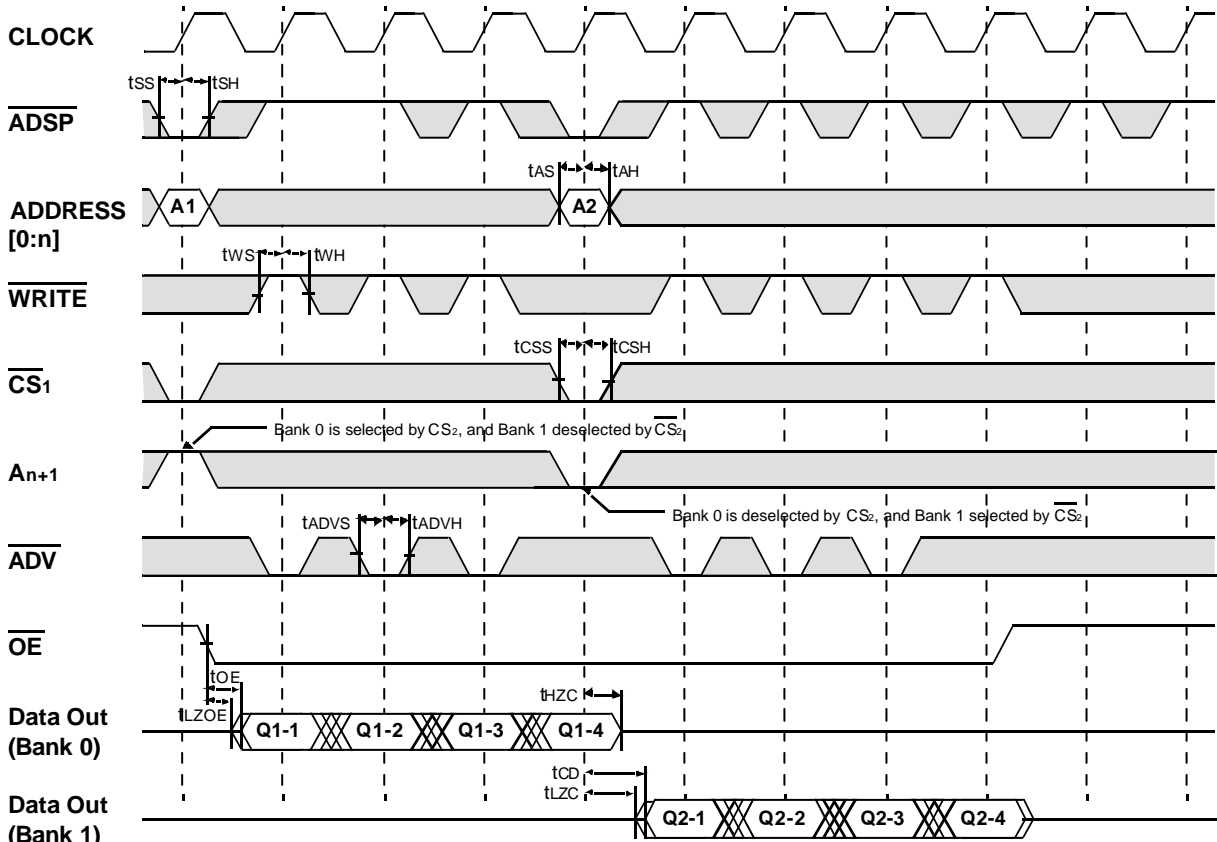

*Notes : n = 14 32K depth , 15 64K depth
 16 128K depth , 17 256K depth
 18 512K depth , 19 1M depth

□ Don't Care ⊗ Undefined

APPLICATION INFORMATION

DEPTH EXPANSION

The Samsung 2Mx18 Synchronous Burst SRAM has two additional chip selects for simple depth expansion. This permits easy secondary cache upgrades from 2M depth to 4M depth without extra logic.

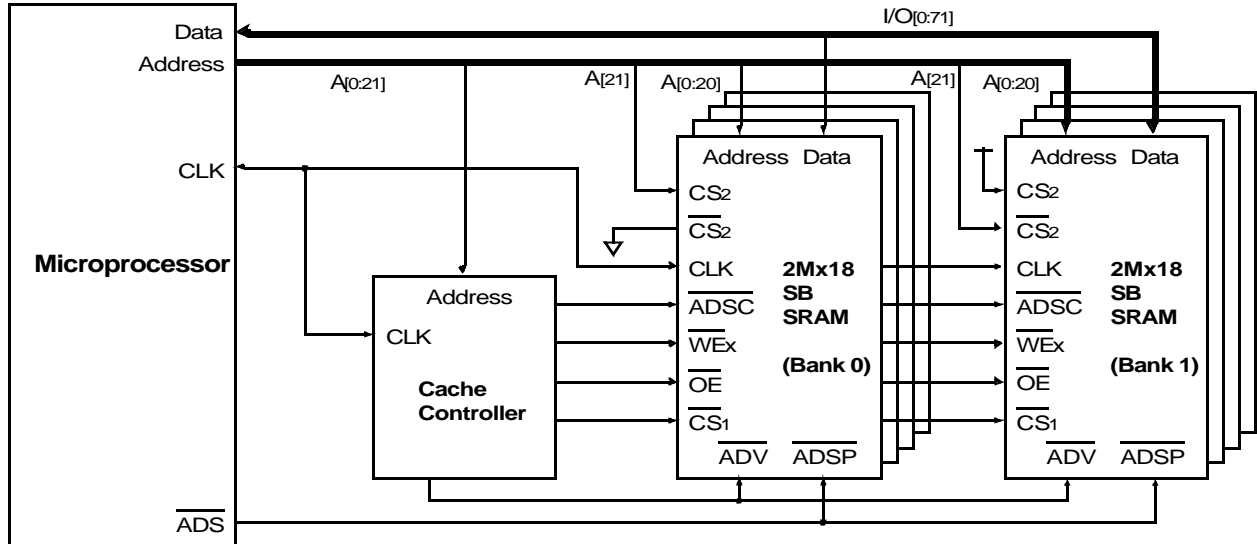

INTERLEAVE READ TIMING (Refer to non-interleave write timing for interleave write timing)

(ADSP CONTROLLED, ADSC=HIGH)

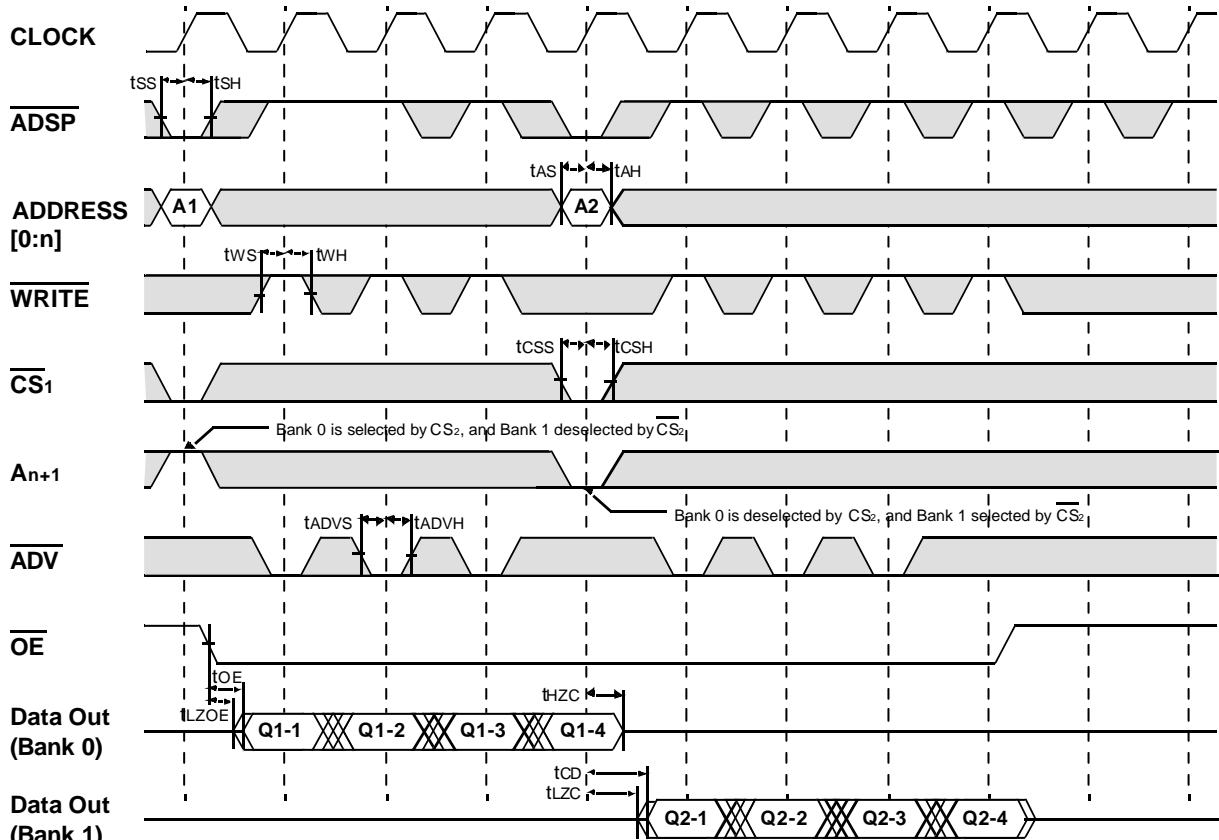

*Notes : n = 14 32K depth, 15 64K depth
16 128K depth, 17 256K depth
18 512K depth, 19 1M depth
20 2M depth

□ Don't Care ⊗ Undefined

PACKAGE DIMENSIONS

