



# STTA3006P/PI STTA6006TV1/2

## TURBOSWITCH™ ULTRA-FAST HIGH VOLTAGE DIODE

### MAIN PRODUCT CHARACTERISTICS

$I_{F(AV)}$	30A / 2 x 30A
$V_{RRM}$	600V
$t_{rr} (typ)$	35ns
$V_F (max)$	1.5V

### FEATURES AND BENEFITS

- SPECIFIC TO "FREEWHEEL MODE" OPERATIONS: FREEWHEEL OR BOOSTER DIODE
- ULTRA-FAST AND SOFT RECOVERY
- VERY LOW OVERALL POWER LOSSES IN BOTH THE DIODE AND THE COMPANION TRANSISTOR
- HIGH FREQUENCY OPERATIONS
- INSULATED PACKAGE: ISOTOP & DOP3I  
Electrical insulation :  $2500V_{RMS}$   
Capacitance < 12 pF (DOP3I)  
Capacitance < 45 pF (ISOTOP)

### DESCRIPTION

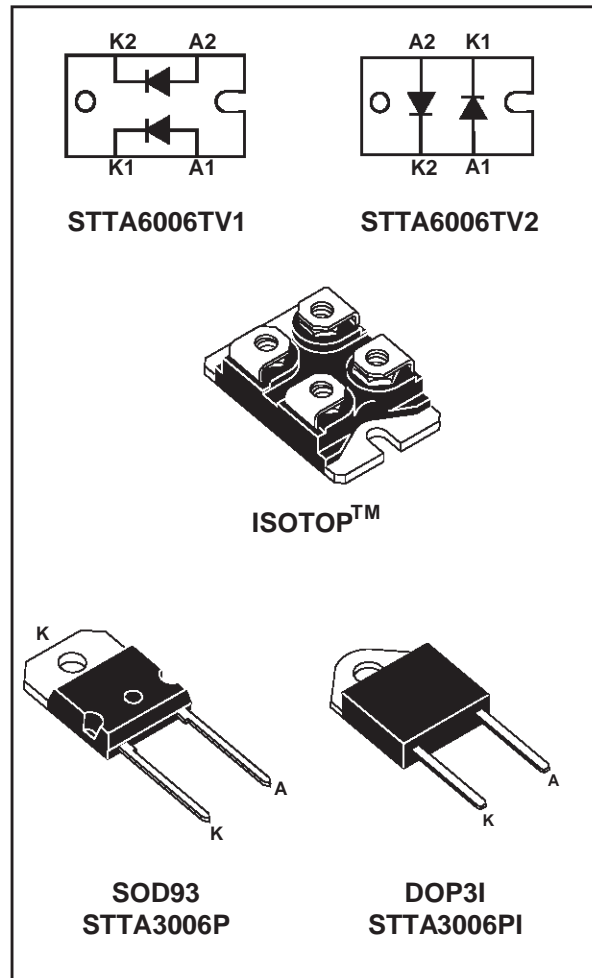
The TURBOSWITCH is a very high performance series of ultra-fast high voltage power diodes from 600V to 1200V.

TURBOSWITCH family, drastically cuts losses in both the diode and the associated switching IGBT or MOSFET in all "freewheel mode" operations and is particularly suitable and efficient in motor control freewheel applications and in booster diode applications in power factor control circuitries. Packaged either in ISOTOP, DOP3I or SOD93 these 600V devices are particularly intended for use on 240V domestic mains.

### ABSOLUTE RATINGS (limiting values, per diode)

Symbol	Parameter	Value	Unit
$V_{RRM}$	Repetitive peak reverse voltage	600	V
$V_{RSM}$	Non repetitive peak reverse voltage	600	V
$I_{F(RMS)}$	RMS forward current	50	A
$I_{FRM}$	Repetitive peak forward current	$t_p=5\mu s$ F=5kHz square	A
$I_{FSM}$	Surge non repetitive forward current	$t_p=10$ ms sinusoidal	A
$T_j$	Maximum operating junction temperature	150	°C
$T_{stg}$	Storage temperature range	-65 to 150	°C

TM : TURBOSWITCH is a trademark of STMicroelectronics



## STTA6006TV1/2/ STTA3006P/PI

### THERMAL AND POWER DATA (Per diode)

Symbol	Parameter	Test conditions		Value	Unit
R <sub>th(j-c)</sub>	Junction to case thermal resistance	ISOTOP	Per diode	1.4	°C/W
			Total	0.75	
		DOP3I		1.8	
		SOD93		1.2	
R <sub>th(c)</sub>		ISOTOP	Coupling	0.1	°C/W
P <sub>1</sub>	Conduction power dissipation I <sub>F(AV)</sub> = 30A δ = 0.5	ISOTOP	T <sub>c</sub> = 74°C	54	W
		DOP3I	T <sub>c</sub> = 52°C		
		SOD93	T <sub>c</sub> = 85°C		
P <sub>max</sub>	Total power dissipation P <sub>max</sub> = P <sub>1</sub> + P <sub>3</sub> (P <sub>3</sub> = 10% P <sub>1</sub> )	ISOTOP	T <sub>c</sub> = 66°C	60	W
		DOP3I	T <sub>c</sub> = 42°C		
		SOD93	T <sub>c</sub> = 78°C		

### STATIC ELECTRICAL CHARACTERISTICS

Symbol	Parameter	Test conditions		Min	Typ	Max	Unit
V <sub>F</sub> *	Forward voltage drop	I <sub>F</sub> = 30A	T <sub>j</sub> = 25°C			1.75	V
			T <sub>j</sub> = 125°C		1.25	1.5	V
I <sub>R</sub> **	Reverse leakage current	V <sub>R</sub> = 0.8 × V <sub>RRM</sub>	T <sub>j</sub> = 25°C			150	μA
			T <sub>j</sub> = 125°C		3	8	mA
V <sub>to</sub>	Threshold voltage	I <sub>p</sub> < 3.I <sub>AV</sub>	T <sub>j</sub> = 125°C			1.15	V
rd	Dynamic resistance					11	mΩ

Test pulses : \* tp = 380 μs, δ < 2%

\*\* tp = 5 ms, δ < 2%

To evaluate the maximum conduction losses use the following equation :

$$P = V_{to} \times I_{F(AV)} + r_d \times I_F^2 (RMS)$$

### DYNAMIC ELECTRICAL CHARACTERISTICS

#### TURN-OFF SWITCHING

Symbol	Parameter	Test conditions	Min	Typ	Max	Unit
t <sub>rr</sub>	Reverse recovery time	T <sub>j</sub> = 25°C I <sub>F</sub> = 0.5 A I <sub>R</sub> = 1A I <sub>rr</sub> = 0.25A I <sub>F</sub> = 1 A dI <sub>F</sub> /dt = -50A/μs V <sub>R</sub> = 30V		35	65	ns
I <sub>RM</sub>	Maximum reverse recovery current	T <sub>j</sub> = 125°C V <sub>R</sub> = 400V I <sub>F</sub> = 30A dI <sub>F</sub> /dt = -240 A/μs dI <sub>F</sub> /dt = -500 A/μs		20	19	A
S factor	Softness factor	T <sub>j</sub> = 125°C V <sub>R</sub> = 400V I <sub>F</sub> = 30A dI <sub>F</sub> /dt = -500 A/μs		0.40		-

TURN-ON SWITCHING

Symbol	Parameter	Test conditions	Min	Typ	Max	Unit
$t_{fr}$	Forward recovery time	$T_j = 25^\circ\text{C}$ $I_F = 30\text{A}$ , $dI_F/dt = 240\text{ A}/\mu\text{s}$ measured at, $1.1 \times V_{FM}$			600	ns
$V_{FP}$	Peak forward voltage	$T_j = 25^\circ\text{C}$ $I_F = 30\text{A}$ , $dI_F/dt = 240\text{ A}/\mu\text{s}$			12	V

Fig. 1: Conduction losses versus average current.

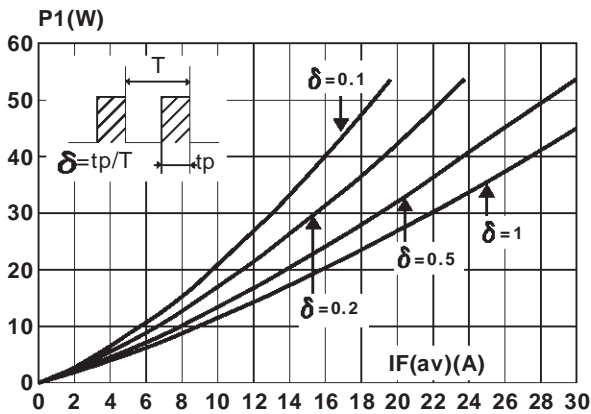


Fig. 2: Forward voltage drop versus forward current.

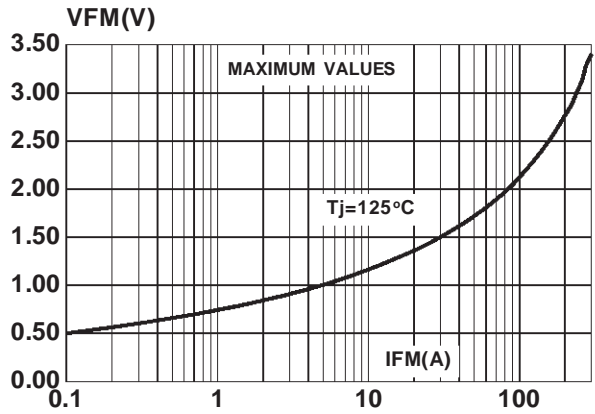


Fig. 3: Relative variation of thermal transient impedance junction to case versus pulse duration.

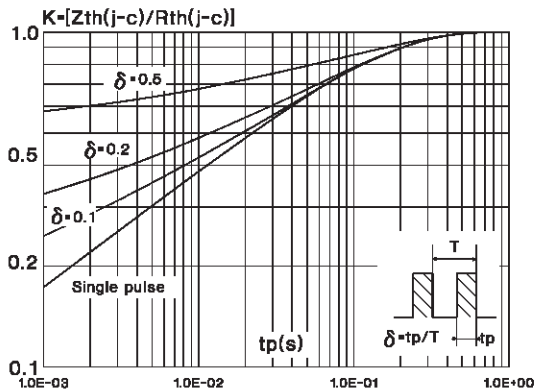


Fig. 4: Peak reverse recovery current versus dIF/dt.

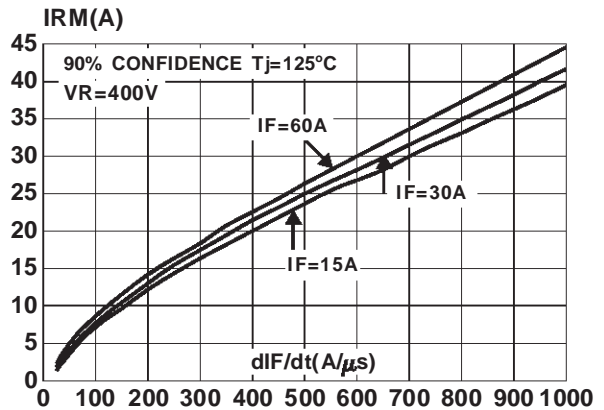


Fig. 5: Reverse recovery time versus  $dI_F/dt$ .

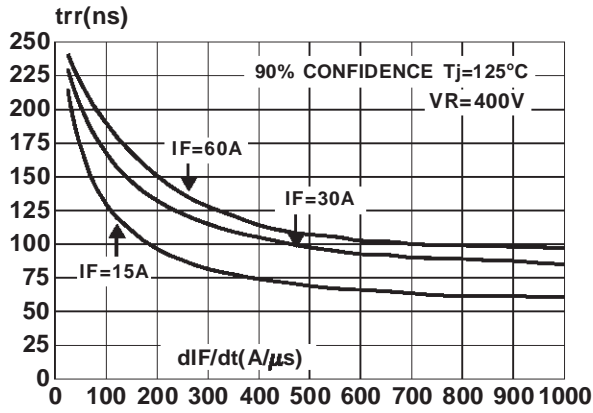


Fig. 6: Softness factor ( $t_b/t_a$ ) versus  $dI_F/dt$ .

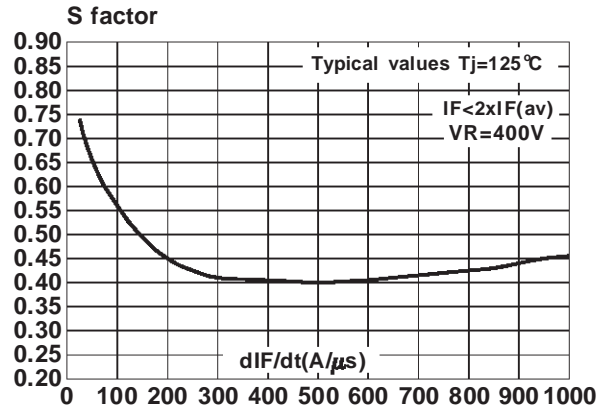


Fig. 7: Relative variation of dynamic parameters versus junction temperature (reference  $T_j=125^\circ C$ ).

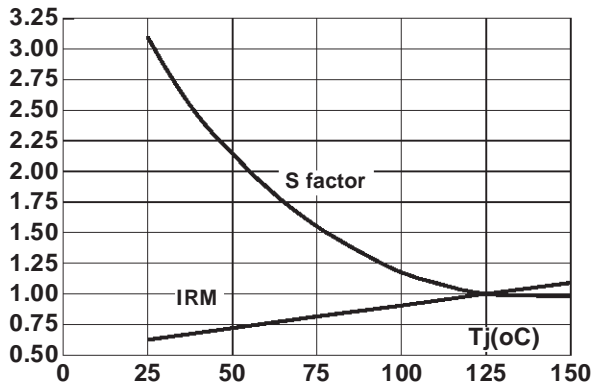


Fig. 8: Transient peak forward voltage versus  $dI_F/dt$ .

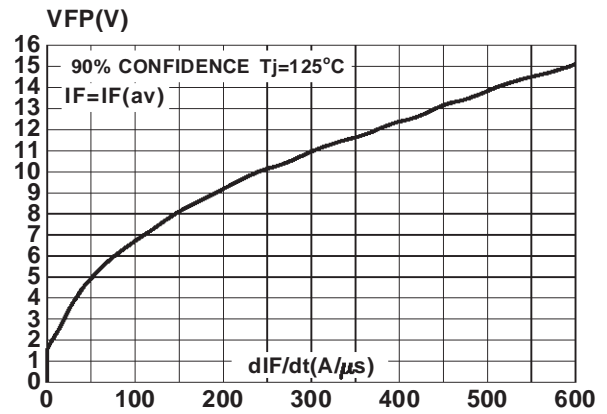
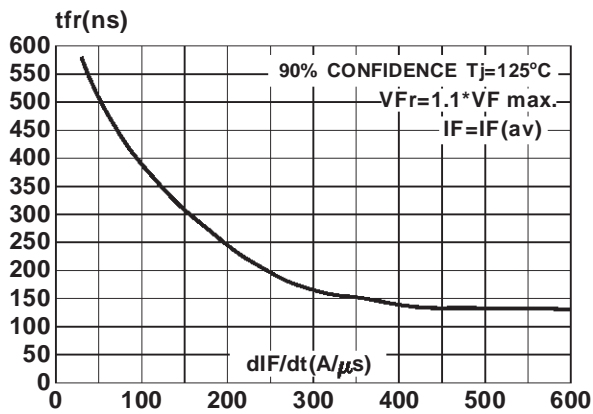


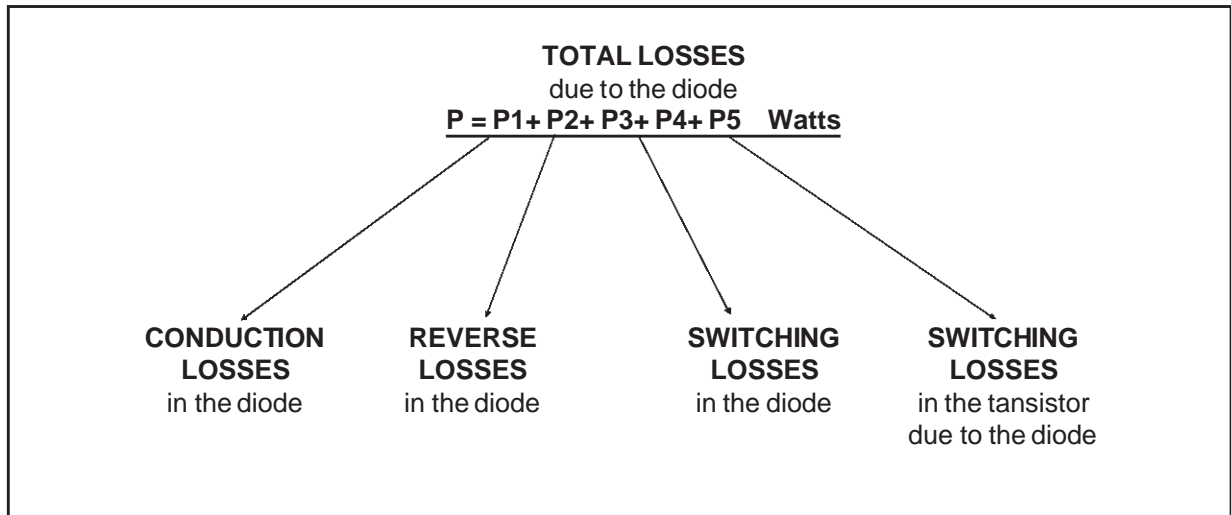
Fig. 9: Forward recovery time versus  $dI_F/dt$ .



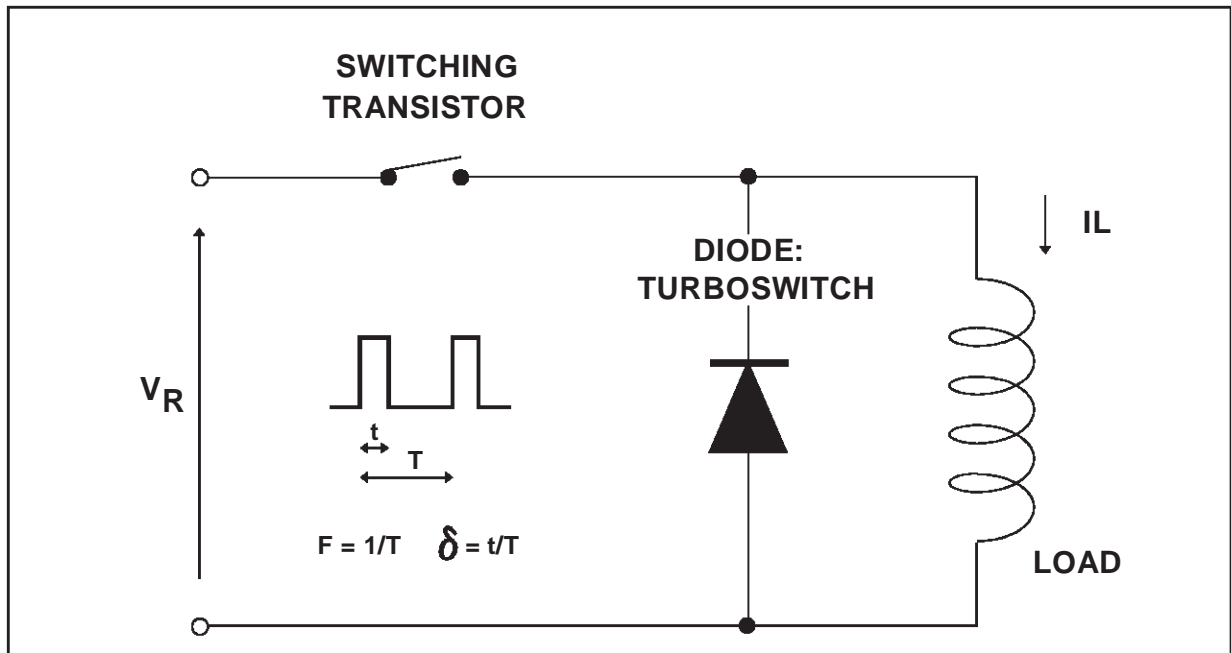
**APPLICATION DATA**

The TURBOSWITCH is especially designed to provide the lowest overall power losses in any "FREEWHEEL Mode" application (Fig.A) considering both the diode and the companion

transistor, thus optimizing the overall performance in the end application. The way of calculating the power losses is given below:

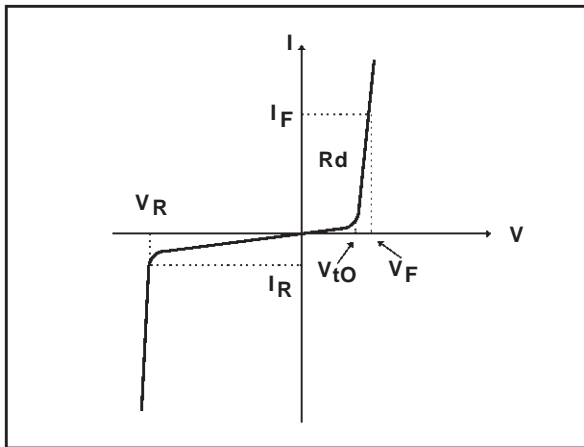


**Fig. A : "FREEWHEEL" MODE.**



APPLICATION DATA (Cont'd)

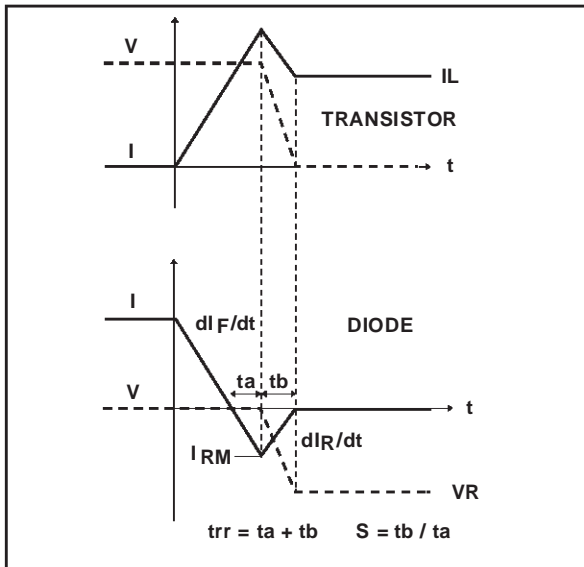
Fig. B: STATIC CHARACTERISTICS



**Conduction losses:**  
 $P1 = V_{t0} \cdot I_{F(AV)} + R_d \cdot I_{F(RMS)}^2$

**Reverse losses:**  
 $P2 = V_R \cdot I_R \cdot (1 - \delta)$

Fig. C: TURN-OFF CHARACTERISTICS



**Turn-on losses:**  
 (in the transistor, due to the diode)

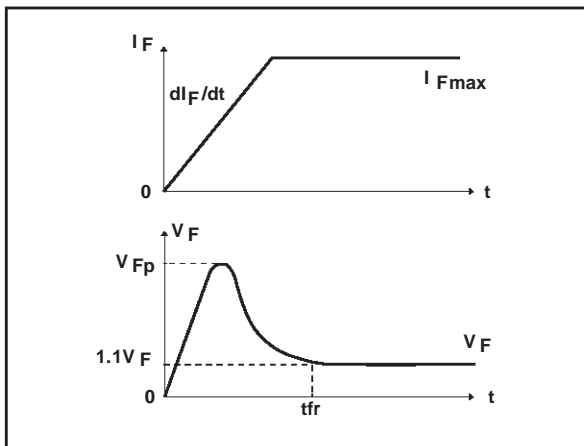
$$P5 = \frac{V_R \times I_{RM}^2 \times (3 + 2 \times S) \times F}{6 \times di/dt} + \frac{V_R \times I_{RM} \times I_L \times (S + 2) \times F}{2 \times di/dt}$$

**Turn-off losses (in the diode):**

$$P3 = \frac{V_R \times I_{RM}^2 \times S \times F}{6 \times dl/dt}$$

P3 and P5 are suitable for power MOSFET and IGBT

Fig. D: TURN-ON CHARACTERISTICS



**Turn-on losses:**  
 $P4 = 0.4 (V_{FP} - V_F) \cdot I_{Fmax} \cdot t_{fr} \cdot F$

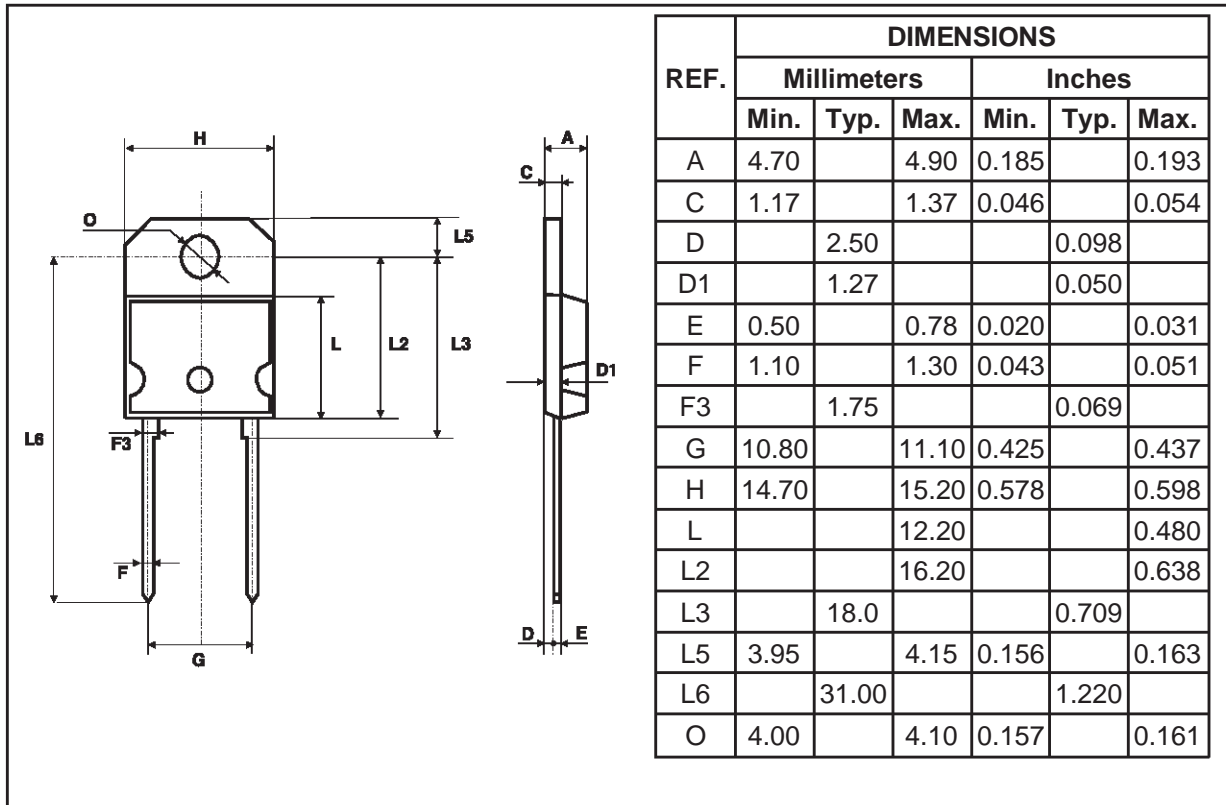
PACKAGE MECHANICAL DATA  
ISOTOP

REF.	DIMENSIONS					
	Millimeters			Inches		
	Min.	Typ.	Max.	Min.	Typ.	Max.
A	11.80		12.20	0.465		0.480
A1	8.90		9.10	0.350		0.358
B	7.8		8.20	0.307		0.323
C	0.75		0.85	0.030		0.033
C2	1.95		2.05	0.077		0.081
D	37.80		38.20	1.488		1.504
D1	31.50		31.70	1.240		1.248
E	25.15		25.50	0.990		1.004
E1	23.85		24.15	0.939		0.951
E2		24.80			0.976	
G	14.90		15.10	0.587		0.594
G1	12.60		12.80	0.496		0.504
G2	3.50		4.30	0.138		0.169
F	4.10		4.30	0.161		0.169
F1	4.60		5.00	0.181		0.197
P	4.00		4.30	0.157		0.69
P1	4.00		4.40	0.157		0.173
S	30.10		30.30	1.185		1.193

Cooling method : by conduction (C)

STTA6006TV1/2/ STTA3006P/PI

PACKAGE MECHANICAL DATA  
SOD93

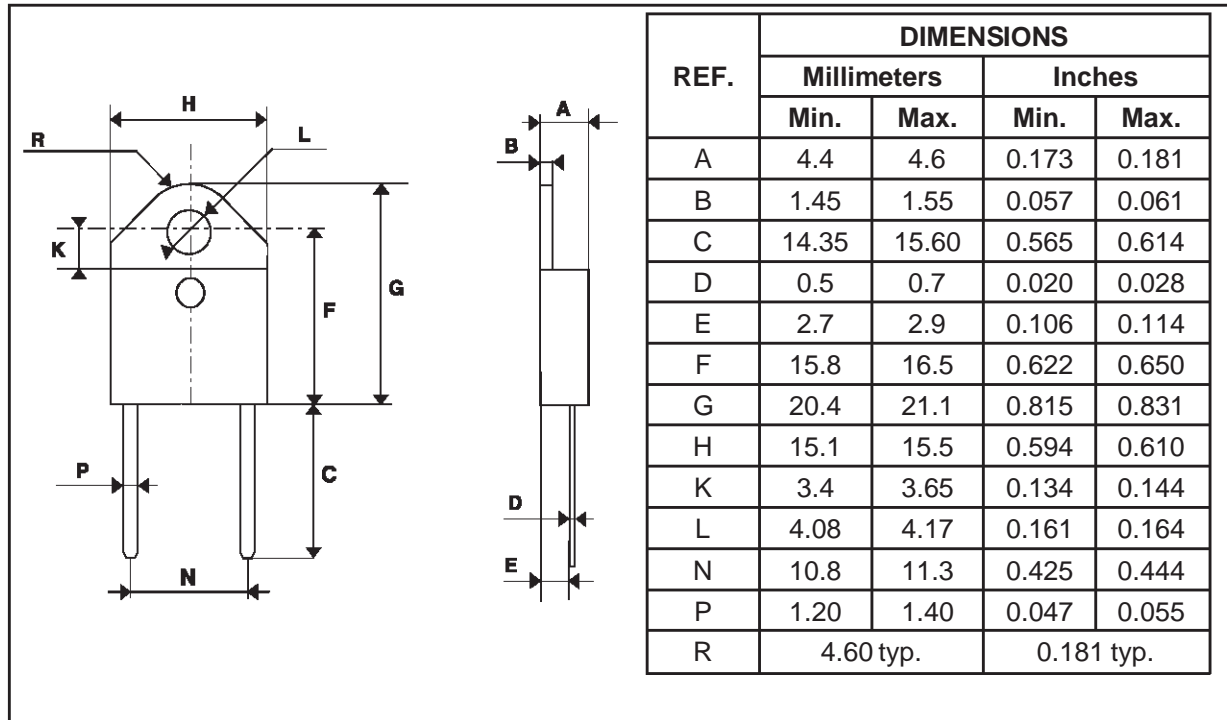


Cooling method : by conduction (C)

Recommended torque value : 0.8 m.N

Maximum torque value : 1 m.N



**PACKAGE MECHANICAL DATA**  
 DOP3I


Cooling method : by conduction (C)

Recommended torque value : 0.8 m.N

Maximum torque value : 1m.N

Ordering type	Marking	Package	Weight	Base qty	Delivery mode
STTA6006P	STTA6006P	SOD93	3.79g	30	Tube
STTA6006PI	STTA6006PI	DOP3I	4.52g	30	Tube
STTA6006TV1	STTA6006TV1	ISOTOP	27g	10	Tube
STTA6006TV2	STTA006TV2	ISOTOP	without screws	10	Tube

■ Epoxy meets UL94,V0

Information furnished is believed to be accurate and reliable. However, STMicroelectronics assumes no responsibility for the consequences of use of such information nor for any infringement of patents or other rights of third parties which may result from its use. No license is granted by implication or otherwise under any patent or patent rights of STMicroelectronics. Specifications mentioned in this publication are subject to change without notice. This publication supersedes and replaces all information previously supplied.

STMicroelectronics products are not authorized for use as critical components in life support devices or systems without express written approval of STMicroelectronics.

The ST logo is a registered trademark of STMicroelectronics

© 1999 STMicroelectronics - Printed in Italy - All rights reserved.

STMicroelectronics GROUP OF COMPANIES

Australia - Brazil - China - Finland - France - Germany - Hong Kong - India - Italy - Japan - Malaysia  
 Malta - Morocco - Singapore - Spain - Sweden - Switzerland - United Kingdom - U.S.A.

<http://www.st.com>