

Ultra-Low Power Consumption Low-Saturation Three-Pin Regulators with On/Off Pin Monolithic ICs MM1065 and 1165

Outline

These ICs are stabilized power supply devices with ultra-low consumption currents, designed for a greatly reduced reactive current at low input voltages, and with a small input/output difference voltage of 0.2V at an output current of 40mA. The output current is limited to a maximum of 100mA, and in the MMP-4A package, an on/off pin enables the device to be switched on and off.

Features

- | | |
|--|--|
| 1. Input/output voltage difference | 0.2V typ. (I _o =40mA) |
| 2. No-load input current | 13μA typ. |
| 3. Maximum reactive current at low input voltages | 15μA typ. (no-load) |
| 4. Maximum output current | 100mA max. |
| 5. Temperature coefficient of output voltage | ±0.01%/°C typ. |
| 6. Output voltage ranks | MM1065, 1165 F : 6.0V±4%
G : 5.0V±4%
H : 4.5V±4%
I : 4.0V±4%
J : 3.0V±4%
Z : 3.3V±4% |
| 7. With overcurrent protection circuit | |
| 8. With thermal shutdown circuit | |
| 9. With function to turn output on and off (MMP-4A package only) | |

On/Off Pin Level	Low	High
MM1065 output	ON	OFF
MM1165 output	OFF	ON

Package

TO-92A (MM1065□T, MM1165□T)

MMP-4A (MM1065□M, MM1165□M)

*The output voltage rank appears in the boxes.

Applications

1. Handheld computers
2. Portable transceivers
3. Cordless phones
4. Other portable equipment which uses batteries

Absolute Maximum Ratings

Item	Symbol	Ratings	Units
Operating temperature	T _{OPR}	-20~+75	°C
Storage temperature	T _{STG}	-40~+125	°C
Power supply current	V _{CC} max.	-0.3~10	V
Output current	I _{OUT}	100	mA
Maximum Ratings	P _d	200 (MMP-4A) 300 (TO-92A)	mW

Electrical Characteristics

Item	Symbol	Measurement conditions	Min.	Typ.	Max.	Units	
Output voltage	V _O	V _{IN} =V _O +1V I _O =40mA	F	5.76	6.00	6.24	V
			G	4.80	5.00	5.20	
			H	4.32	4.50	4.68	
			I	3.84	4.00	4.16	
			J	2.88	3.00	3.12	
			Z	3.17	3.30	3.43	
No-load input current	I _{ccq1}	V _{IN} =V _O +1V, I _O =0mA		13	20	μA	
Minimum I/O voltage difference	V _d min.	V _{IN} =V _O min., I _O =40mA		0.2	0.3	V	
Input fluctuation rate	ΔV ₂	V _{IN} =(V _O +1V)~10V, I _O =40mA		±0.01	±0.1	%/V	
Load fluctuation rate	ΔV ₁	V _{IN} =V _O +1V, I _O =0~100mA		±0.01	±0.03	%/mA	
Output voltage temperature coefficient	ΔV _O /T	T _j =-20~+75°C		±100		ppm/°C	
Ripple rejection rate	RR	V _{RIPPLE} =1V, V _{IN} =V _O +2V f=120Hz, I _O =40mA	50	60		dB	

Equivalent Circuit Diagram

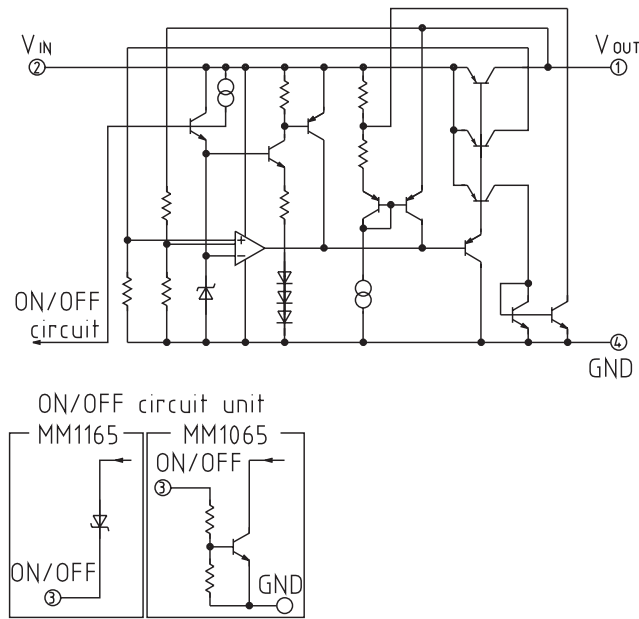

Electrical Characteristics (MMP-4P)

Item	Symbol	Measurement conditions		Min.	Typ.	Max.	Units
Input current while off	I _{ccq2}	MM1065	V _{IN} =6V V(ON/OFF)=High		2.5	7	μA
		MM1165	V _{IN} =6V V(ON/OFF)=Low		3	6	μA
On/off pin current while off	I _{OFF}	MM1065	V(ON/OFF)=2.4V		4	7	μA
		MM1165	V(ON/OFF)=0.4V		0.2	0.1	μA
On/off pin level							
On/off pin high level	High			2.4		V _{IN} +0.3	V
On/off pin low level	Low			-0.3		0.4	V

Basic Circuit Connection Diagram

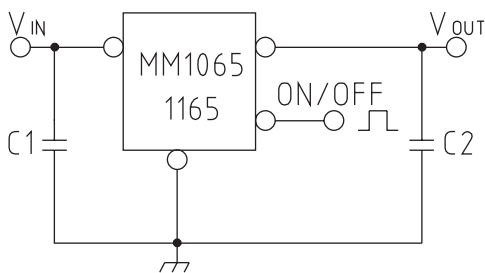

[C1 ≥ 1μF (ceramic)
C2 ≥ 1μF (ceramic)

On/Off Pin Level	Low	High
MM1065 output	ON	OFF
MM1165 output	OFF	ON

Characteristics

I/O voltage difference

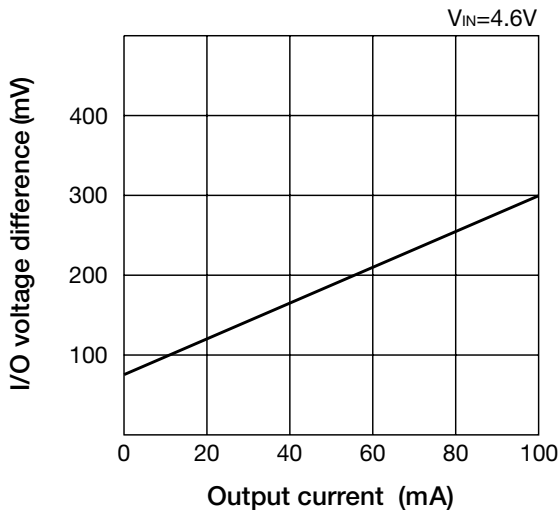

No-load input current

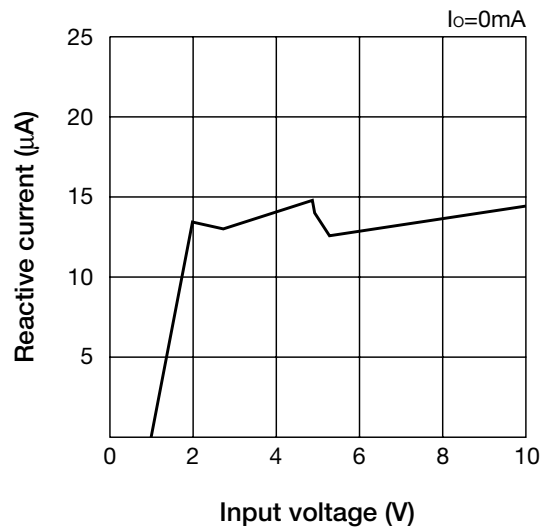

Load fluctuation rate

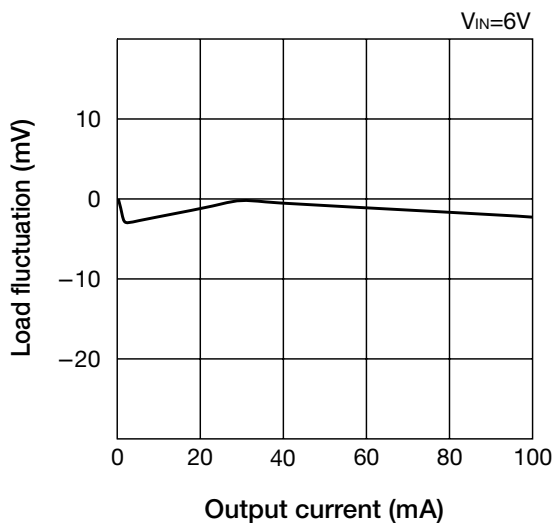

Input fluctuation rate

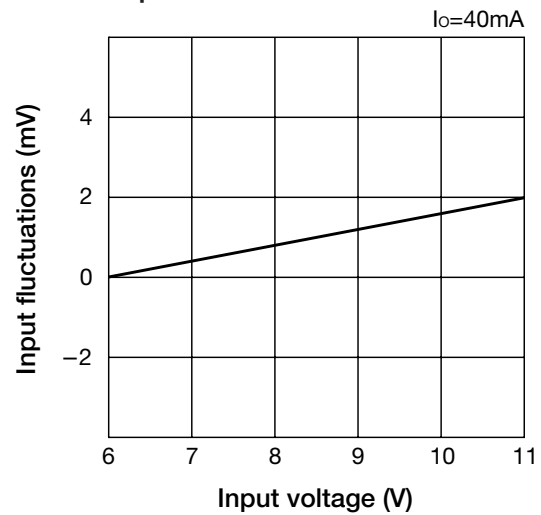

Output voltage characteristic

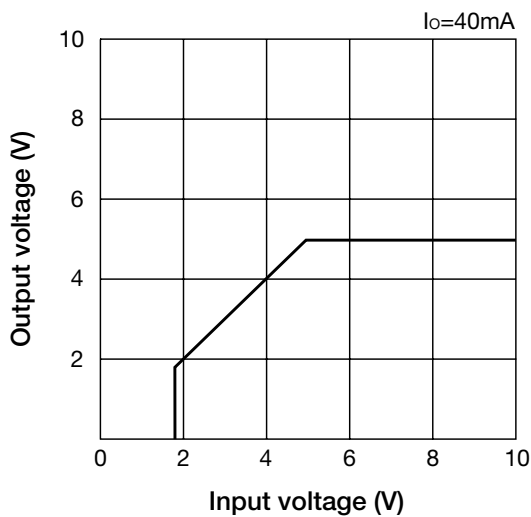

Output voltage temperature characteristic

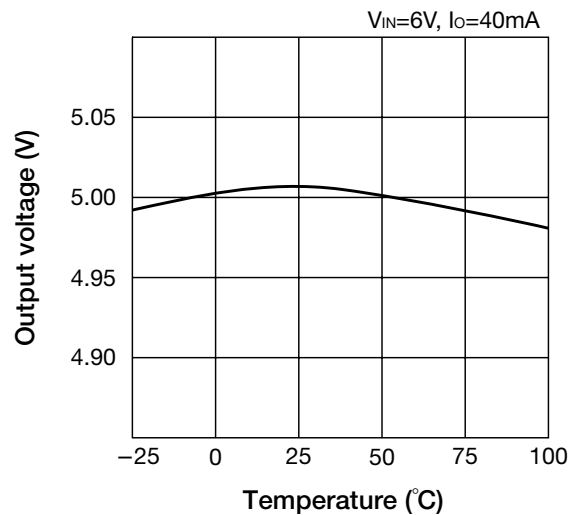

■ Load transient response

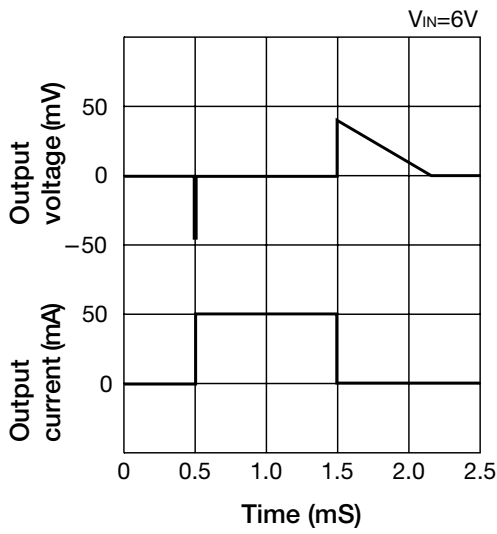

■ Transient response to input fluctuation

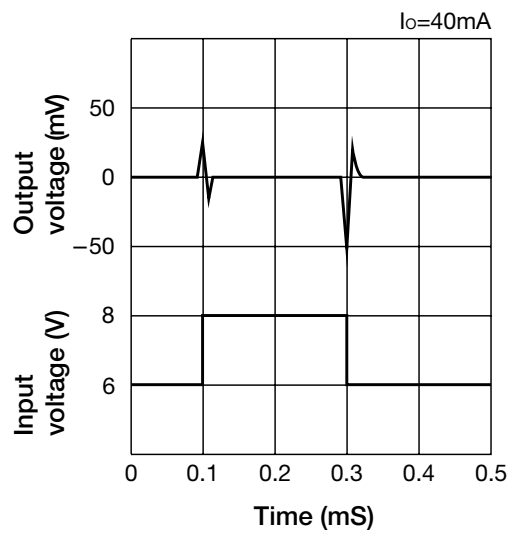

■ Allowable loss

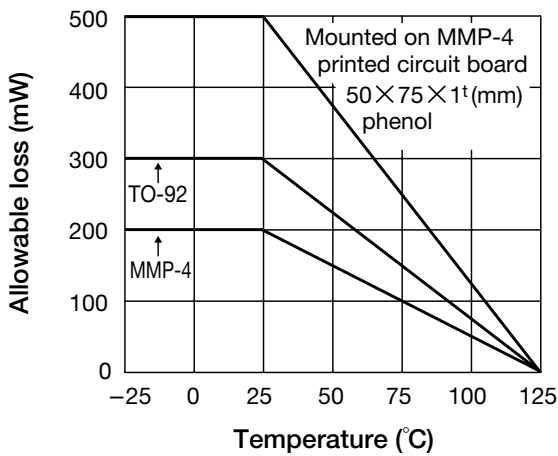

■ Ripple rejection rate

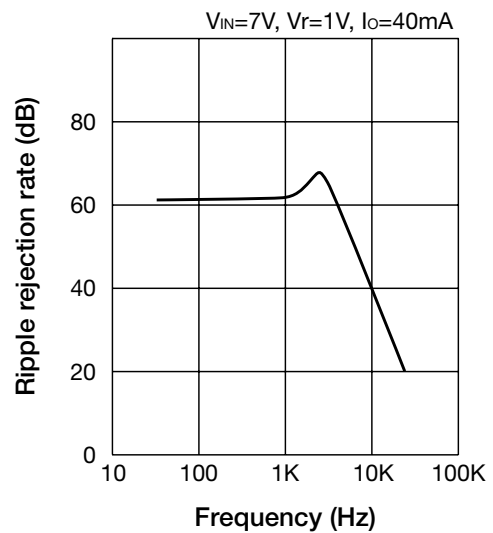

■ Thermal shutdown

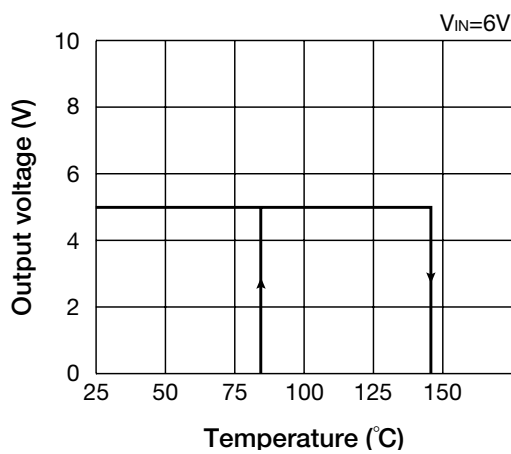

■ Output current characteristic

