

SANYO	No. ※ 4435A	LC587008, 587006, 587004
		Single-Chip 4-Bit Microprocessors with LCD Driver, 2 Kb RAM, and 8, 12, or 16 KB ROM on chip

Preliminary

Overview

The LC587004, LC587006 and LC587008 are 80-pin low-voltage CMOS 4-bit microprocessors that include LCD drivers, 2 Kb RAM and 8, 12, or 16 KB ROM on chip. These microprocessors correspond to the earlier LC5870 series with the 256 by 4-bit on-chip RAM expanded to a 512 by 4-bit capacity.

Applications

- System control and LCD display in CD players, cameras and radio tuners
- System control and LCD display in miniature test equipment and consumer health care products
- These microprocessors are optimal for products that include LCD displays and, in particular, battery operated products.
- Remote controllers for VCRs and audio equipment

Functions

- Program ROM: 8064 × 16 bits (LC587008), 6144 × 16 bits (LC587006) and 4096 × 16 bits (LC587004)
- RAM: 512 × 4 bits on chip
- All instructions execute in a single cycle
- Cycle time and operating voltage ranges
 - 2 μs cycle time: $V_{DD} = 2.8$ to 6.0 V
 - 10 μs cycle time: $V_{DD} = 2.2$ to 6.0 V
 - 122 μs cycle time: $V_{DD} = 2.0$ to 6.0 V
- Rich set of HALT/HOLD mode clearing and interrupt functions
 - Eight HALT mode clearing functions
 - Seven HOLD mode clearing functions
 - Seven interrupt functions (all of which can be used as external interrupts)
 - Subroutines can be nested up to eight levels (including interrupt handling)
 - Built-in watchdog timer function

- Powerful hardware for improved processing capacity
 - Built-in segment PLA and segment decoder: LCD panel segments can be handled with no software processing of the LCD driver outputs. Also, the LCD drive pins can be switched to function as output ports.
 - Built-in 8-bit synchronous serial I/O circuit
 - One 8-bit programmable timer (that can be used as an event counter)
 - One 8-bit programmable reload timer (that can be used to generate a remote control carrier signal)
 - The whole RAM area can be used as working area (by using the RAM bank register)
 - Built-in RAM data pointer
 - Built-in clock oscillator and 15-bit divider (also used to generate the LCD alternating frequency)
- Highly flexible LCD panel drive output pins (35 pins)

LCD panel	Number of	Required
drive type.....	segments	common pins	
1/3 bias 1/4 duty	140 segments	Four pins
1/3 bias 1/3 duty	105 segments	Three pins
1/2 bias 1/4 duty	140 segments	Four pins
1/2 bias 1/3 duty	105 segments	Three pins
1/2 bias 1/2 duty	70 segments	Two pins
Static.....	35 segments	One pin

The LCD output pins can be switched to function as general-purpose outputs.

 - C-MOS type: Up to 35 pins
 - P-channel type: Up to 35 pins
 - N-channel type: Up to 35 pins
- These microprocessors allow the use of an oscillator appropriate to the application system specifications.
 - Crystal oscillator: 32 kHz, 65 kHz or 38 kHz (for the time base, system clock or LCD alternating frequency)
 - Ceramic oscillator: 400 kHz to 4 Mhz (for the system clock and the timers and serial counter)
 - RC oscillator: 200 kHz to 1 MHz (for the system clock and the timers and serial counter)
 - External clock (for the system clock and the timers and serial counter)

SANYO Electric Co., Ltd. Semiconductor Business Headquarters

TOKYO OFFICE Tokyo Bldg., 1-10, 1 Chome, Ueno, Taito-ku, TOKYO, 110 JAPAN

Features

- These microprocessors are the top end of the LC5870 series and have the following features.

Faster cycle times

- Cycle time: 2 μ s for VDD between 4.5 and 6.0 V
- Cycle time: 10 μ s for VDD between 2.2 and 6.0 V

Low power dissipation HALT mode (typical)

Continuous operation (typical)

- Ceramic filter (CF) 4 MHz (5.0 V) 600 μ A 1.7 mA (cycle time = 2 μ s)
- Crystal oscillator 32 kHz (3.0 V, CF stopped) 4.0 μ A 20 μ A (cycle time = 122 μ s)

Improved timer functions

- One 8-bit programmable timer (that can be used as an event counter)
- One 8-bit programmable reload timer (that can be used to generate a remote control carrier signal)
- Time base timer (for use as a clock)
- Watchdog timer

Improved standby functions

- Clock standby function (HALT mode), software switching between low speed mode (low current) and high speed mode
- Full standby mode (HOLD mode)
- HALT and HOLD modes can be cleared by external interrupt pins, input ports (up to nine pins) and serial I/O interrupts

Improved I/O functions

- External interrupt pins
 - Up to 9 input and I/O pins that can clear HALT and HOLD modes
 - Up to 24 input ports with built-in software controllable input resistors (either pull-up or pull-down specified as mask options)
 - Up to 25 input port pins with a built-in floating prevention circuit
 - LCD driver: four common pins and 35 segment pins
 - General-purpose I/O ports: 20 pins (of which 12 are p-channel open drain and 4 are n-channel open drain)
 - General-purpose inputs: five pins
 - General-purpose outputs (type 1): four pins (LED direct drive pins, one internal alarm signal output pin and one carrier output pin)
 - General-purpose outputs (type 2): 35 pins (when all 35 LCD segment port pins are switched over to function as general-purpose outputs)
 - Eight-bit serial I/O port: one set (three pins: input, output and clock)
- Delivery formats: QIP80 and chip

Package Dimensions

unit: mm

3044B-QIP80A

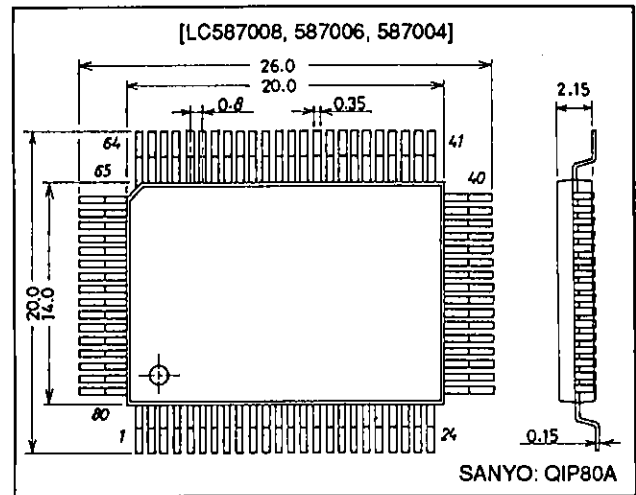

Pad Layout

Chip size: 5.12 mm × 5.29 mm
 Pad size: 120 μm × 120 μm
 Chip thickness: 480 μm (chip products)

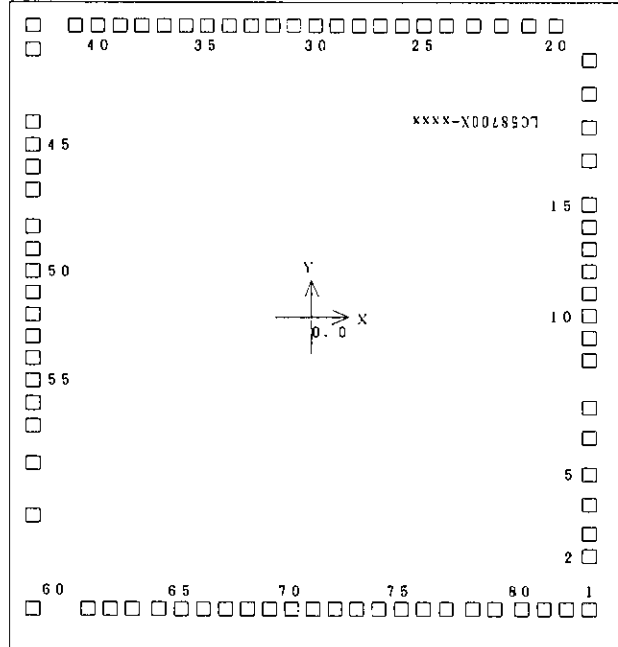

Pin Assignments/Pad Names and Coordinates

Pin No.	Pad No.	Symbol	Coordinates		Pin No.	Pad No.	Symbol	Coordinates		Pin No.	Pad No.	Symbol	Coordinates	
			X _{μm}	Y _{μm}				X _{μm}	Y _{μm}				X _{μm}	Y _{μm}
24	1	V _{DD}	2234	-2319	52	29	Seg 9	155	2449	78	57	Seg 35	-2362	-824
25	2	CFIN	2234	-1883	53	30	Seg 10	-24	2449	79	58	COM4	-2362	-1139
26	3	CFOUT	2234	-1701	54	31	Seg 11	-204	2449	80	59	COM3	-2362	-1564
27	4	S1	2234	-1458	55	32	Seg 12	-384	2449	1	60	COM2	-2362	-2319
28	5	S2	2234	-1212	56	33	Seg 13	-564	2449	2	61	COM1	-1912	-2319
29	6	S3	2234	-915	57	34	Seg 14	-744	2449	3	62	CUP1	-1730	-2319
30	7	S4	2234	-669	58	35	Seg 15	-923	2449	4	63	CUP2	-1549	-2319
31	8	K1	2234	-284	59	36	Seg 16	-1103	2449	5	64	RES	-1327	-2319
32	9	K2	2234	-101	60	37	Seg 17	-1283	2449	6	65	INT	-1145	-2319
33	10	K3	2234	81	61	38	Seg 18	-1463	2449	7	66	SO1	-963	-2319
34	11	K4	2234	264	62	39	Seg 19	-1643	2449	8	67	SO2	-780	-2319
35	12	M1	2234	448	—	40	Test	-1821	2449	9	68	SO3	-597	-2319
36	13	M2	2234	631	—	41	Test	-2001	2449	10	69	SO4	-414	-2319
37	14	M3	2234	814	63	42	Seg 20	-2362	2449	11	70	A1	-231	-2319
38	15	M4	2234	997	64	43	Seg 21	-2362	2248	12	71	A2	-48	-2319
39	16	N1	2234	1352	65	44	Seg 22	-2362	1649	13	72	A3	134	-2319
40	17	N2	2234	1624	66	45	Seg 23	-2362	1468	14	73	A4	317	-2319
41	18	N3	2234	1895	67	46	Seg 24	-2362	1288	15	74	P1	504	-2319
42	19	N4	2234	2173	68	47	Seg 25	-2362	1107	16	75	P2	687	-2319
43	20	TST	1958	2449	69	48	Seg 26	-2362	799	17	76	P3	870	-2319
44	21	Seg 1	1732	2449	70	49	Seg 27	-2362	618	18	77	P4	1053	-2319
45	22	Seg 2	1506	2449	71	50	Seg 28	-2362	438	19	78	XTOUT	1279	-2319
46	23	Seg 3	1280	2449	72	51	Seg 29	-2362	257	20	79	XTIN	1462	-2319
47	24	Seg 4	1054	2449	73	52	Seg 30	-2362	77	21	80	V _{DD2}	1685	-2319
48	25	Seg 5	874	2449	74	53	Seg 31	-2362	-103	22	81	V _{DD1}	1868	-2319
49	26	Seg 6	694	2449	75	54	Seg 32	-2362	-283	23	82	V _{SS}	2050	-2319
50	27	Seg 7	514	2449	76	55	Seg 33	-2362	-464					
51	28	Seg 8	335	2449	77	56	Seg 34	-2362	-664					

- Note:
1. Pin numbers are for QIP80 package products.
 2. Connect the test pins (TST) to V_{SS}.
 3. Pad numbers 40 and 41 must be left open in the chip specification product.
 4. Do not use dip-soldering techniques to mount the QIP80 package versions.
 5. For chip products either connect the substrate to V_{SS} or leave it open.

System Block Diagram

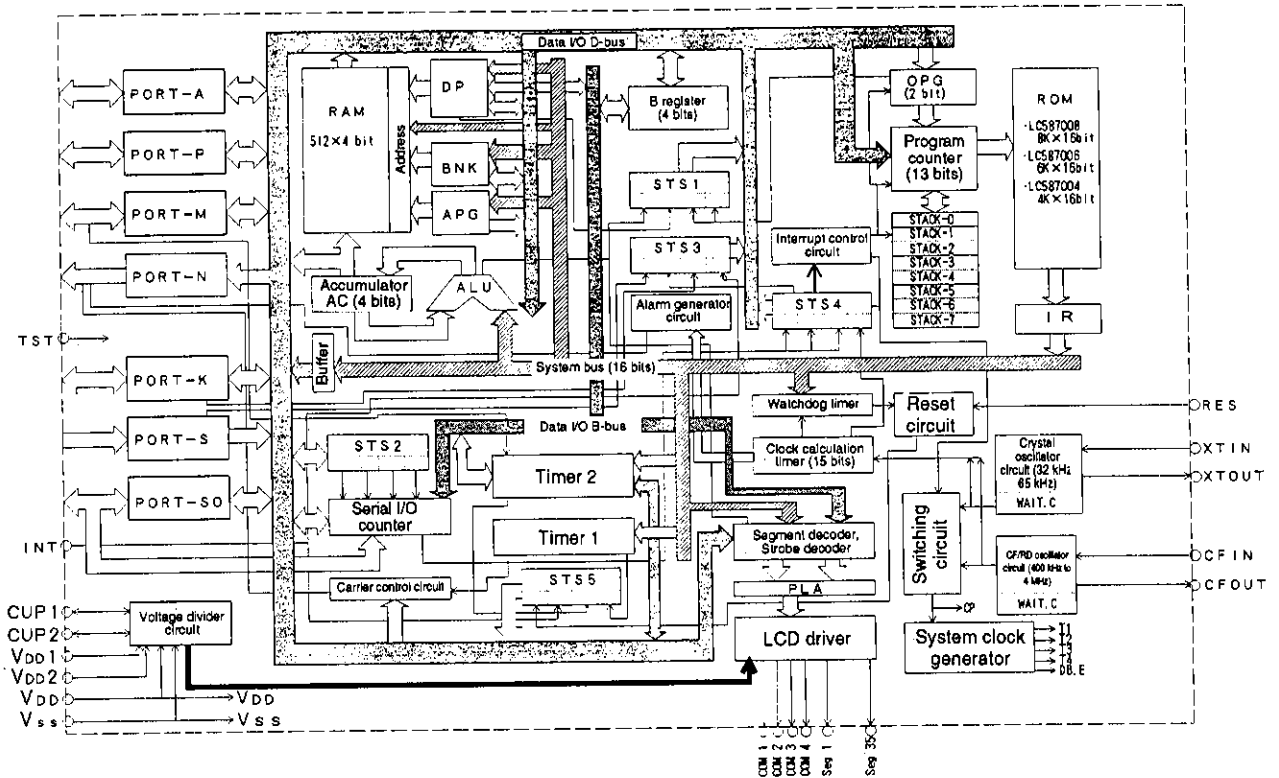

System Block Diagram for the LC587008, LC587006 and LC587004

- | | | | |
|------|---------------------------|---------|--|
| RAM: | Data memory | IR: | Instruction register |
| ROM: | Program memory | STS1: | Status register 1 |
| DP: | Data pointer register | STS2: | Status register 2 |
| BNK: | Bank register | STS3: | Status register 3 |
| APG: | RAM page flags | STS4: | Status register 4 |
| AC: | Accumulator | STS5: | Status register 5 |
| ALU: | Arithmetic and logic unit | PLA: | Segment data and strobe programmable logic array |
| B: | B register | WAIT.C: | Waiting time counter |
| OPG: | ROM page flag | | |
| PC: | Program counter | | |

Pin Functions

Pin	I/O	QIP-80 Pin No.	Function	Option	At reset																									
V _{DD} V _{SS}	— —	24 23	Power supply																											
V _{DD1} V _{DD2}	— —	22 21	LCD drive power supply <table border="1" style="margin-left: 20px;"> <thead> <tr> <th></th> <th>NON</th> <th>1/1bias</th> <th>1/2bias</th> <th>1/3bias</th> </tr> </thead> <tbody> <tr> <td>V_{DD}</td> <td></td> <td></td> <td></td> <td></td> </tr> <tr> <td>V_{DD1}</td> <td></td> <td></td> <td></td> <td></td> </tr> <tr> <td>V_{DD2}</td> <td></td> <td></td> <td></td> <td></td> </tr> <tr> <td>V_{SS}</td> <td></td> <td></td> <td></td> <td></td> </tr> </tbody> </table>		NON	1/1bias	1/2bias	1/3bias	V _{DD}					V _{DD1}					V _{DD2}					V _{SS}						
	NON	1/1bias	1/2bias	1/3bias																										
V _{DD}																														
V _{DD1}																														
V _{DD2}																														
V _{SS}																														
CUP1 CUP2	— —	3 4	Switching pin used to supply the LCD drive voltage to the V _{DD1} and V _{DD2} pins • Connect a nonpolarized capacitor between CUP1 and CUP2 when 1/2 or 1/3 bias is used. • Leave open when a bias other than 1/2 or 1/3 is used.																											
CFIN	Input	25	System clock oscillator connections • Ceramic resonator connection (CF specifications) • RC component connection (RC specifications) • External signal input pin (CFOUT is left open)	• CF specifications • RC specifications • External specifications • Not used																										
CFOUT	Output	26	This oscillator is stopped by the execution of a STOP or SLOW instruction.																											
XTIN	Input	20	Reference calculation (clock specifications, LCD alternating frequency), system clock oscillator • 32 kHz crystal resonator connection • 65 kHz crystal resonator connection	• 32k specifications • 65k specifications • 38k specifications • Not used																										
XTOUT	Output	19	This oscillator is stopped by the execution of a STOP instruction.																											
S1 S2 S3 S4	Input	27 28 29 30	Input-only ports • Input pins used to read data into RAM • Built-in 7.8 ms and 1.95 ms chatter rejection circuits • Built-in pull-up/pull-down resistors Note: The 7.8 ms and 1.95 ms times are the times when $\theta 0$ is 32.768 kHz.	• Transistors to hold a low or high level • Selection of either pull-up or pull-down resistors	• The pull-up or pull-down resistors are on. Note: These pins go to the floating state when reset is cleared.																									
K1 K2 K3 K4	I/O	31 32 33 34	I/O ports • Input pins used to read data into RAM • Output pins used to output data from RAM • Built-in 7.8 ms and 1.95 ms input-mode chatter rejection circuits. The selection of 7.8 or 1.95 ms is linked to that for the S ports. Note: The 7.8 ms and 1.95 ms times are the times when $\theta 0$ is 32.768 kHz.	• Transistors to hold a low or high level • Selection of either pull-up or pull-down resistors	• The pull-up or pull-down resistors are on. Note: These pins go to the floating state when reset is cleared. • Input mode • Output latch data is set high.																									
M1 M2 M3 M4	I/O	35 36 37 38	I/O ports • Input pins used to read data into RAM • Output pins used to output data from RAM • M4 is used as the external clock input pin in TM2 mode 3. * The minimum period for the external clock is twice the cycle time. • Built-in pull-up/pull-down resistors	The same as K1 to K4	The same as K1 to K4																									
A1 A2 A3 A4	I/O	11 12 13 14	I/O ports • Input pins used to read data into RAM • Output pins used to output data from RAM • Built-in pull-up/pull-down resistors	The same as K1 to K4	The same as K1 to K4																									
P1 P2 P3 P4	I/O	15 16 17 18	I/O ports Function: The same as pins A1 to A4	The same as K1 to K4	The same as K1 to K4																									

Continued on next page.

LC587008, 587006, 587004

Continued from preceding page.

Pin	I/O	QIP-80 Pin No.	Function	Option	At reset
SO1 SO2 SO3 SO4	I/O	7 8 9 10	<p>I/O ports</p> <p>Function: The same as for pins A1 to A4</p> <p>Pins SO1 to SO3 area also used for the serial interface.</p> <ul style="list-style-type: none"> Use of these pins in serial mode can be selected under program control. Pin functions: SO1: Serial input pin SO2: Serial output pin SO3: Serial clock pin <p>The serial clock pin can be switched between internal and external, and between rising edge output and falling edge output.</p>	<ul style="list-style-type: none"> Transistors to hold a low or high level Selection of either pull-up or pull-down resistors Internal serial clock divisor selection I 1/1 II 1/2 III 1/4 	The same as for K1 to K4
N1 N2 N3 N4	Output	39 40 41 42	<p>Output-only ports</p> <ul style="list-style-type: none"> Output pins used to output data from RAM An alarm signal can be output from pin N4. (Note that this is only when the N4 output latch is low.) An alarm signal modulated at 1, 2 or 4 kHz can be output. (These frequencies are output when $\theta 0$ is 32.768 kHz.) A carrier signal can be output from N3. (Note that this is only when the N3 output latch is low.) 	<ul style="list-style-type: none"> Pins N1 to N4 output circuit type: I CMOS II N-channel open drain Pins N1 to N4 output level I High level II Low level 	The output levels on pins N1 to N4 can be specified as an option.
INT	Input	6	<p>Input ports</p> <ul style="list-style-type: none"> External interrupt request inputs Input pins used to read data into RAM Input detection can be performed on either rising or falling edges. Built-in pull-up/pull-down resistors 	<ul style="list-style-type: none"> Transistors to hold a low or high level Selection of either pull-up or pull-down resistors Signal conversion (rising/falling) selection 	
RES	Input	5	<p>LSI internal reset input</p> <ul style="list-style-type: none"> The reset input level can be selected to be either high or low. Built-in pull-up/pull-down resistors Note: The reset pulse must be at least 500 μs. 	<ul style="list-style-type: none"> Only when the input resistor open specification is selected 	
TST	Input	43	<p>Test input</p> <ul style="list-style-type: none"> QIP80 products: Connect to V_{SS}. Chip products: Leave open or connect to V_{SS}. 		
Seg1, Seg2 to Seg35	Output	44, 45 to 78	<ul style="list-style-type: none"> LCD panel drive/general-purpose output <ul style="list-style-type: none"> LCD panel drive <ul style="list-style-type: none"> I STATIC II 1/2 bias - 1/2 duty III 1/2 bias - 1/3 duty IV 1/2 bias - 1/4 duty V 1/3 bias - 1/3 duty VI 1/3 bias - 1/4 duty Types I to V can be specified as mask options. General-purpose output mode <ul style="list-style-type: none"> I CMOS II P-channel open drain III N-channel open drain Types I to III can be specified as mask options. LCD/general-purpose output control is handled by the segment PLA, and thus program control is not required. These pins support output latch control on reset and in standby states when the oscillators are stopped. Arbitrary combinations of LCD drive and general-purpose outputs can be used. 	<ul style="list-style-type: none"> LCD driver/general-purpose output switching LCD drive type switching <ul style="list-style-type: none"> STATIC <ul style="list-style-type: none"> 1/2 bias - 1/2 duty 1/2 bias - 1/3 duty 1/2 bias - 1/4 duty 1/3 bias - 1/3 duty 1/3 bias - 1/4 duty General-purpose output circuit switching <ul style="list-style-type: none"> CMOS P-channel open drain N-channel open drain Output latch control in standby modes 	<ul style="list-style-type: none"> LCD drive <ul style="list-style-type: none"> All segments on All segments off *: Determined by mask options General purpose outputs <ul style="list-style-type: none"> High level Low level *: Determined by mask options Note: When a combination of LCD drive and general-purpose outputs, the output state is either: <ul style="list-style-type: none"> All lit/high level All off/low level. These pins go to the static drive mode during the reset period.

Continued on next page.

Continued from preceding page.

Pin	I/O	QIP-80 Pin No.	Function	Option	At reset																														
COM1 COM2 COM3 COM4	Output	2 1 80 79	<p>LCD panel drive common polarity outputs</p> <p>The table below shows how these pins are used depending on the duty used. (Values for alternating frequency reflect a typical specification of 32.768 MHz for $\phi 0$.)</p> <table border="1"> <thead> <tr> <th></th> <th>Static duty</th> <th>1/2 duty</th> <th>1/3 duty</th> <th>1/4 duty</th> </tr> </thead> <tbody> <tr> <td>COM1</td> <td>○</td> <td>○</td> <td>○</td> <td>○</td> </tr> <tr> <td>COM2</td> <td>×</td> <td>○</td> <td>○</td> <td>○</td> </tr> <tr> <td>COM3</td> <td>×</td> <td>×</td> <td>○</td> <td>○</td> </tr> <tr> <td>COM4</td> <td>×</td> <td>×</td> <td>×</td> <td>○</td> </tr> <tr> <td>Alternation frequency</td> <td>32 Hz</td> <td>32 Hz</td> <td>42.7 Hz</td> <td>32 Hz</td> </tr> </tbody> </table> <p>Note: A cross (X) indicates that the pin is not used with that duty type.</p>		Static duty	1/2 duty	1/3 duty	1/4 duty	COM1	○	○	○	○	COM2	×	○	○	○	COM3	×	×	○	○	COM4	×	×	×	○	Alternation frequency	32 Hz	32 Hz	42.7 Hz	32 Hz		<p>The static drive waveform is output during the reset period.</p> <p>* There are cases where the alternating frequency stops for the CF, RC and external dock specifications. (These cases differ depending on option specifications.)</p>
	Static duty	1/2 duty	1/3 duty	1/4 duty																															
COM1	○	○	○	○																															
COM2	×	○	○	○																															
COM3	×	×	○	○																															
COM4	×	×	×	○																															
Alternation frequency	32 Hz	32 Hz	42.7 Hz	32 Hz																															

Sample Application Circuit

LCD: 1/2 bias - 1/4 duty

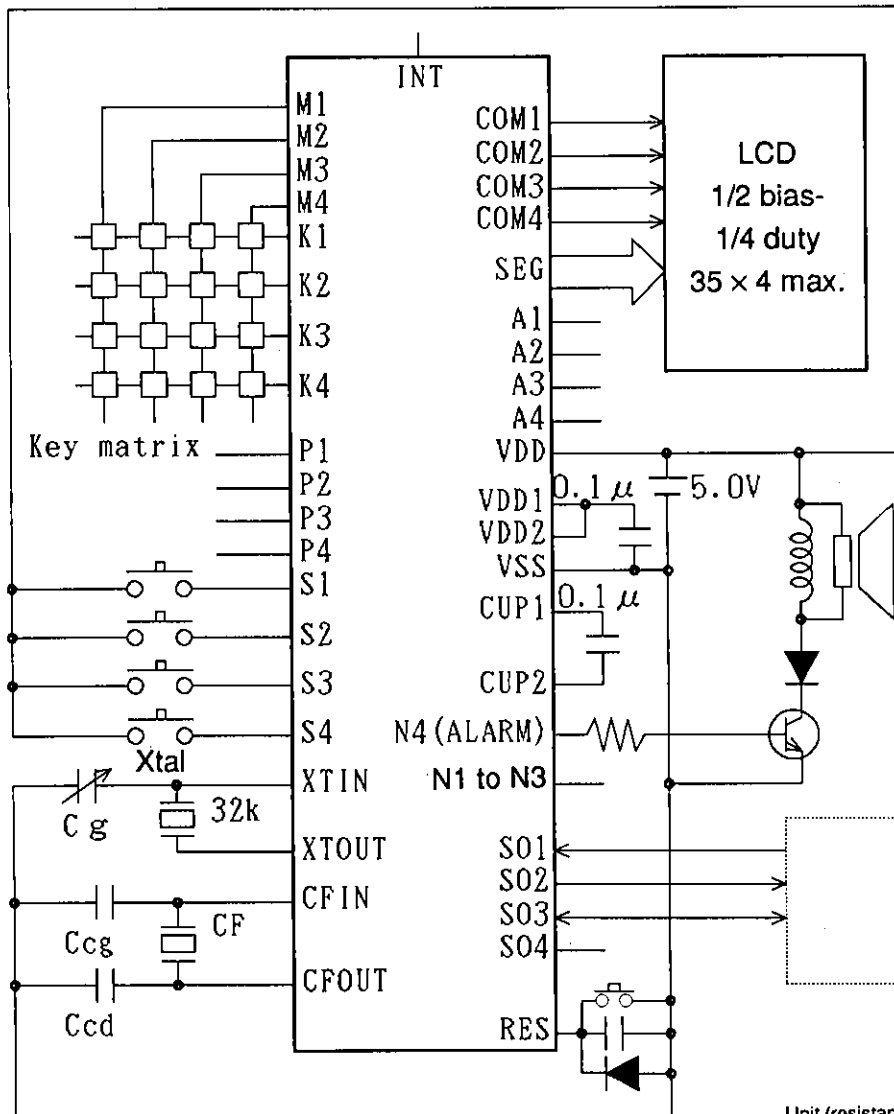

Unit (resistance:Ω, capacitance:F)

Oscillator Circuit Options

Option	Circuit configuration	Note
<p>RC and Xtal</p>		<ul style="list-style-type: none"> • The cycle time is four times the f_1 period. • The divider outputs ($\phi 1$ to $\phi 15$) are used as the time base, the LCD drive waveform generation clock, the S and K port chattering rejection clock and for other functions. • OSC1 is stopped when a SLOW instruction is executed.
<p>CF and Xtal • 400 kHz (CF) • 4 MHz (CF)</p>		<ul style="list-style-type: none"> • The cycle time is four times n times the f_1 period. (Note: n is 2.) • The divider outputs ($\phi 1$ to $\phi 15$) are used as the time base, the LCD drive waveform generation clock, the S and K port chattering rejection clock and for other functions. • OSC1 is stopped when a SLOW instruction is executed.
<p>RC</p>		<ul style="list-style-type: none"> • The cycle time is four times the f_1 period. • The divider outputs ($\phi 1$ to $\phi 15$) are used as the LCD drive waveform generation clock, the S and K port chattering rejection clock and for other functions.

Continued on next page.

Continued from preceding page.

Option	Circuit configuration	Note
<p>CF</p> <ul style="list-style-type: none"> • 400 kHz • 4 MHz 		<ul style="list-style-type: none"> • The cycle time is four times n times the f_1 period. (Note: n is 2.) • The divider outputs ($\phi 1$ to $\phi 15$) are used as the LCD drive waveform generation clock, the S and K port chattering rejection clock and for other functions.
<p>Xtal</p>		<ul style="list-style-type: none"> • The cycle time is four times the f_2 period. • The divider outputs ($\phi 1$ to $\phi 15$) are used as the time base, the LCD drive waveform generation clock, the S and K port chattering rejection clock and for other functions.
<p>External input</p>		<ul style="list-style-type: none"> • The cycle time is four times n times the f_1 period. (Note: n is 2.) • The divider outputs ($\phi 1$ to $\phi 15$) are used as the LCD drive waveform generation clock, the S and K port chattering rejection clock and for other functions.

Crystal Oscillator Circuit Options

Option	Circuit configuration	Note
32 kHz oscillator		The resistor Rd (200 kΩ typical) for use with a 32 kHz oscillator is built in.
5 kHz oscillator 38 kHz oscillator		<ul style="list-style-type: none"> The cycle time is four times n times the f1 period. (Note: n is 2.) The divider outputs (ø1 to ø15) are used as the time base, the LCD drive waveform generation clock, the S and K port chattering rejection clock and for other functions. OSC1 is stopped when a SLOW instruction is executed.

Input Port Options

Option	Circuit configuration	Note																									
Selection of either the • Built-in pull-up resistor, or the • Built-in pull-down resistor option		<p>The following ports are switched at the same time</p> <ul style="list-style-type: none"> S1 to S4, K1 to K4, M1 to M4, P1 to P4 SO1 to SO4 and A1 to A4 <p>At reset: The resistors are on during the reset period. The resistors are turned off when reset is cleared.</p> <p>Options: Either A or B can be selected. One of A and B must be selected.</p>																									
Selection of high or low level hold transistor	<p>Combination examples</p> <table border="1"> <thead> <tr> <th>Type</th> <th>1</th> <th>2</th> <th>3</th> <th>4</th> </tr> </thead> <tbody> <tr> <td>Pull-up resistor (A)</td> <td>On</td> <td>On</td> <td></td> <td></td> </tr> <tr> <td>Pull-down resistor (B)</td> <td></td> <td></td> <td>On</td> <td>On</td> </tr> <tr> <td>High level hold transistor (C)</td> <td>On</td> <td></td> <td></td> <td></td> </tr> <tr> <td>Low level hold transistor (D)</td> <td></td> <td></td> <td>On</td> <td></td> </tr> </tbody> </table>	Type	1	2	3	4	Pull-up resistor (A)	On	On			Pull-down resistor (B)			On	On	High level hold transistor (C)	On				Low level hold transistor (D)			On		<p>When the hold transistors used option is selected:</p> <ul style="list-style-type: none"> Used to reduce the current flowing in the pull-up or pull-down resistors when, for example, a push switch is used for S1 or a slide switch is used for S2. For input open specification versions, the resistors are turned on before the input is read, the input state is read and then the resistors are turned off. If the input is floating at this point the high or low level hold transistor operates to hold the value read. <p>When the hold transistors unused option is selected:</p> <ul style="list-style-type: none"> Use with the pull-up or pull-down resistor in the on state. Select hold transistors unused when connecting to external control signals and the connections will never be floating
Type	1	2	3	4																							
Pull-up resistor (A)	On	On																									
Pull-down resistor (B)			On	On																							
High level hold transistor (C)	On																										
Low level hold transistor (D)			On																								

INT Pins

Option	Circuit configuration	Note
Pull-up resistor, pull-down resistor or resistor open selection	<p>The diagram shows an INT pin connected to a pull-up resistor and a pull-down resistor. The signal path includes a high level hold transistor and a low level hold transistor. An edge detection circuit is connected to the INT pin and outputs to an interrupt request signal. The edge detection circuit is connected to SF2-D0 (S, Q) and RF2-D0 (R) registers, which are also connected to an initial reset signal.</p>	<p>Built-in resistor selection</p> <ul style="list-style-type: none"> • Pull-up resistor used • Pull-down resistor used • Used open
High or low level hold transistor selection		<p>Input signal level hold transistor selection</p> <ul style="list-style-type: none"> • High level hold transistor used • Low level hold transistor used • Level hold transistors unused
Rising edge or falling edge detection selection		<p>Signal change edge detection switching</p> <ul style="list-style-type: none"> • Change on rising signal • Change on falling signal

RES Pin

Option	Circuit configuration	Note
Pull-up resistor, pull-down resistor or resistor open and reset level selection	<p>The diagram shows a RES pin connected to a pull-up resistor (A) and a pull-down resistor (B). The signal path includes an inverter and a reset level selection circuit. The reset level selection circuit is connected to "H" reset and "L" reset signals.</p>	<p>Built-in resistor and polarity selection</p> <ul style="list-style-type: none"> • Pull-up resistor connected, low level reset • Pull-down resistor connected, high level reset • Resistors open, low level reset • Resistors open, high level reset

Pins N1 to N4

Option	Circuit configuration	Note
N-channel/CMOS selection	<p>The diagram shows four pins (N1, N2, N3, N4) connected to a mask switched logic circuit. The signal path includes a carrier signal and an alarm generation circuit. The alarm generation circuit is connected to SAS instruction and OPN instruction signals. The output of the mask switched logic circuit is connected to a data bus (20, 21, 22, 23).</p>	<ul style="list-style-type: none"> • Selection of CMOS or n-channel open drain circuit type • Pins N1 to N4 can be specified independently • The output level during reset can be specified. <ul style="list-style-type: none"> — High level — Low level

Fifteen-Stage Divider Overflow Time

Option	Circuit configuration	Note
<ul style="list-style-type: none"> • 1000 ms/250 ms • 500 ms/125 ms 	<p>Note: The 125 to 1000 ms times are for a divider input of 32.768 kHz.</p>	<p>A 15-stage (15-bit) divider is provided on chip to count the reference time. One of two types of divider overflow detection can be selected as a mask option and a further selection of two types can be made under program control. One of these mask options must be specified.</p>

K Input Port Options

Option	Circuit configuration	Note
<p>Pull-up/pull-down resistor selection</p>		<p>When the pull-up/pull-down resistor selection is made, the K port input detection switching gate is switched accordingly.</p> <p>A: When all of K1 to K4 are high and even one pin goes low a signal is applied to the edge detection circuit. (Applies to the pull-up specifications.)</p> <p>Note: When even one of the K1 to K4 pins is low, the edge detection circuit will not operate for any combination of high or low values on the other pins.</p> <p>B: The opposite of item A</p>

Mask Option Overview

1. Port resistor selection (ports S, K, P, M, A and SO)
 - Pull-up resistor specification
 - Pull-down resistor specification
2. S port high or low level hold transistors
 - Level hold transistors used
 - No level hold transistors
3. K port high or low level hold transistors
 - Level hold transistors used
 - No level hold transistors
4. M port high or low level hold transistors
 - Level hold transistors used
 - No level hold transistors
5. P port high or low level hold transistors
 - Level hold transistors used
 - No level hold transistors
6. A port high or low level hold transistors
 - Level hold transistors used
 - No level hold transistors
7. SO port high or low level hold transistors
 - Level hold transistors used
 - No level hold transistors
8. INT pin resistor selection and signal edge selection
 - Pull-up resistor (negative edge)
 - Pull-down resistor (positive edge)
 - Open (negative edge)
 - Open (positive edge)
9. INT pin level hold transistor selection
 - Low or high level hold transistors used
 - No low or high level hold transistors
10. RES pin
 - Pull-up resistor (low level reset)
 - Pull-down resistor (high level reset)
 - Open (low level reset)
 - Open (high level reset)
11. N1 pin
 - N-channel open drain type
 - CMOS type
12. N2 pin
 - N-channel open drain type
 - CMOS type
13. N3 pin
 - N-channel open drain type
 - CMOS type

14. N4 pin
 - N-channel open drain type
 - CMOS type
15. N port initial level
 - High level
 - Low level
16. OSC specifications
 - CF only (ceramic filter)
 - RC only (resistor and capacitor oscillator)
 - Crystal only (32 to 65 kHz crystal oscillator)
 - CF + crystal
 - RC + crystal
 - External + crystal
17. CF/External
 - 400 kHz or 800 kHz
 - 1 MHz, 2 MHz or 4 MHz
18. Crystal oscillator
 - 32 kHz
 - 65 kHz
 - 38 kHz
19. Fifteen-bit counter overflow
 - $\phi/2048$ or $\phi/8192$
 - $\phi/4096$ or $\phi/16384$
20. Serial I/O internal clock period
 - Cycle time $\times 1 \times 2$
 - Cycle time $\times 2 \times 2$
 - Cycle time $\times 4 \times 2$
21. LCD driver
 - Static
 - 1/2 bias – 1/2 duty
 - 1/2 bias – 1/3 duty
 - 1/2 bias – 1/4 duty
 - 1/3 bias – 1/3 duty
 - 1/3 bias – 1/4 duty
22. LCD alternating frequency
 - Slow
 - Typical
 - Fast
23. Internal reset circuit
 - Selection
 - Disabled
24. Segment ports at reset
 - LCD drive pins
 - All on
 - All off
 - CMOS, p/n-channel type pins
 - High level
 - Low level

Internal Register Functions

Symbol	R/W	Function	Initialization value at reset																																																																																																																																																						
PC	—	<p>Program counter The PC is a 13-bit counter that indicates the address in program memory (ROM) of the next instruction to execute. Normally the PC is incremented on every instruction cycle in the range 000H to 1F7FH. (Addresses in the range 1F80 to 1FFF are reserved for testing and cannot be used by user programs.) However, data values are loaded into the PC by the execution of branch and subroutine instructions and on the occurrence of interrupts or an initial reset. The table below describes the data loaded for these operations.</p> <table border="1"> <thead> <tr> <th>Operation</th> <th>PC</th> <th>PC12</th> <th>PC11</th> <th>PC10</th> <th>PC9</th> <th>PC8</th> <th>PC7</th> <th>PC6</th> <th>PC5</th> <th>PC4</th> <th>PC3</th> <th>PC2</th> <th>PC1</th> <th>PC0</th> </tr> </thead> <tbody> <tr> <td>Initializing reset</td> <td></td> <td>0</td> <td>0</td> <td>0</td> <td>0</td> <td>0</td> <td>0</td> <td>0</td> <td>0</td> <td>0</td> <td>0</td> <td>0</td> <td>0</td> <td>0</td> </tr> <tr> <td>INT pin external interrupt</td> <td></td> <td>0</td> <td>0</td> <td>0</td> <td>0</td> <td>0</td> <td>0</td> <td>0</td> <td>1</td> <td>0</td> <td>0</td> <td>0</td> <td>0</td> <td>0</td> </tr> <tr> <td>S/K pin external interrupt</td> <td></td> <td>0</td> <td>0</td> <td>0</td> <td>0</td> <td>0</td> <td>0</td> <td>0</td> <td>1</td> <td>0</td> <td>1</td> <td>0</td> <td>0</td> <td>0</td> </tr> <tr> <td>Timer 1 or timer 2 internal interrupt</td> <td></td> <td>0</td> <td>0</td> <td>0</td> <td>0</td> <td>0</td> <td>0</td> <td>0</td> <td>1</td> <td>1</td> <td>0</td> <td>0</td> <td>0</td> <td>0</td> </tr> <tr> <td>Serial counter internal interrupt or SO4 pin external interrupt</td> <td></td> <td>0</td> <td>0</td> <td>0</td> <td>0</td> <td>0</td> <td>0</td> <td>0</td> <td>1</td> <td>1</td> <td>1</td> <td>0</td> <td>0</td> <td>0</td> </tr> <tr> <td>Unconditional jump (JMP)</td> <td>Page</td> <td>P10</td> <td>P9</td> <td>P8</td> <td>P7</td> <td>P6</td> <td>P5</td> <td>P4</td> <td>P3</td> <td>P2</td> <td>P1</td> <td>P0</td> <td></td> <td></td> </tr> <tr> <td>Conditional jump (BAB0, BAB1, BAB2, BAB3, BAZ, BANZ, BCH, BCNH)</td> <td>Page</td> <td>P10</td> <td>P9</td> <td>P8</td> <td>P7</td> <td>P6</td> <td>P5</td> <td>P4</td> <td>P3</td> <td>P2</td> <td>P1</td> <td>P0</td> <td></td> <td></td> </tr> <tr> <td>Call instruction (CALL)</td> <td>Page</td> <td>P10</td> <td>P9</td> <td>P8</td> <td>P7</td> <td>P6</td> <td>P5</td> <td>P4</td> <td>P3</td> <td>P2</td> <td>P1</td> <td>P0</td> <td></td> <td></td> </tr> <tr> <td>Return instruction (RTS, RTSR)</td> <td colspan="14">CALL address + 1</td> </tr> </tbody> </table> <p>Page: the ROM page flags, which take 2048 locations as a single page The page is specified with the MROPF and SROPF instructions. P00 to P10: Bits in the instruction code (i.e., immediate data)</p>	Operation	PC	PC12	PC11	PC10	PC9	PC8	PC7	PC6	PC5	PC4	PC3	PC2	PC1	PC0	Initializing reset		0	0	0	0	0	0	0	0	0	0	0	0	0	INT pin external interrupt		0	0	0	0	0	0	0	1	0	0	0	0	0	S/K pin external interrupt		0	0	0	0	0	0	0	1	0	1	0	0	0	Timer 1 or timer 2 internal interrupt		0	0	0	0	0	0	0	1	1	0	0	0	0	Serial counter internal interrupt or SO4 pin external interrupt		0	0	0	0	0	0	0	1	1	1	0	0	0	Unconditional jump (JMP)	Page	P10	P9	P8	P7	P6	P5	P4	P3	P2	P1	P0			Conditional jump (BAB0, BAB1, BAB2, BAB3, BAZ, BANZ, BCH, BCNH)	Page	P10	P9	P8	P7	P6	P5	P4	P3	P2	P1	P0			Call instruction (CALL)	Page	P10	P9	P8	P7	P6	P5	P4	P3	P2	P1	P0			Return instruction (RTS, RTSR)	CALL address + 1														
Operation	PC	PC12	PC11	PC10	PC9	PC8	PC7	PC6	PC5	PC4	PC3	PC2	PC1	PC0																																																																																																																																											
Initializing reset		0	0	0	0	0	0	0	0	0	0	0	0	0																																																																																																																																											
INT pin external interrupt		0	0	0	0	0	0	0	1	0	0	0	0	0																																																																																																																																											
S/K pin external interrupt		0	0	0	0	0	0	0	1	0	1	0	0	0																																																																																																																																											
Timer 1 or timer 2 internal interrupt		0	0	0	0	0	0	0	1	1	0	0	0	0																																																																																																																																											
Serial counter internal interrupt or SO4 pin external interrupt		0	0	0	0	0	0	0	1	1	1	0	0	0																																																																																																																																											
Unconditional jump (JMP)	Page	P10	P9	P8	P7	P6	P5	P4	P3	P2	P1	P0																																																																																																																																													
Conditional jump (BAB0, BAB1, BAB2, BAB3, BAZ, BANZ, BCH, BCNH)	Page	P10	P9	P8	P7	P6	P5	P4	P3	P2	P1	P0																																																																																																																																													
Call instruction (CALL)	Page	P10	P9	P8	P7	P6	P5	P4	P3	P2	P1	P0																																																																																																																																													
Return instruction (RTS, RTSR)	CALL address + 1																																																																																																																																																								
ROM	R/O	<p>Program memory The ROM memory consists of 4096 x 16 bits (4 kwords or 8 kbytes) in the LC587004, 6144 x 16 bits (6 kwords or 12 kbytes) in the LC587006 and 8064 x 16 bits (8 kwords or 16 kbytes) in the LC587008. ROM hold user programs to be executed.</p>																																																																																																																																																							
RAM	R/W	<p>Data memory These microprocessors provide an on-chip RAM that consists of 512 x 4 bits (2 Kb). This RAM is accessed as two 256 x 4-bit pages. RAM addresses can be specified in four ways as listed below.</p> <ul style="list-style-type: none"> • Directly specified at 00H to FFH (immediate addressing) • Indirect specification using the 8-bit data pointer. • Indirect specification by the 4-bit RAM bank register multiplied by 10H plus immediate data in the range 0 to FH. • Indirect specification by the 4-bit RAM bank register multiplied by 10H plus 8H plus immediate data in the range 0 to FH. <p>Writing to RAM is always performed through the accumulator.</p>	Undefined																																																																																																																																																						

Continued on next page.

Continued from preceding page.

Symbol	R/W	Function	Initialization value at reset																																				
RAM	R/W	<div style="text-align: center;"> </div> <div style="text-align: center;"> <p>RAM address</p> <table border="1" style="margin: auto;"> <tr> <td>A)</td> <td>P7</td> <td>P6</td> <td>P5</td> <td>P4</td> <td>P3</td> <td>P2</td> <td>P1</td> <td>P0</td> </tr> <tr> <td>B)</td> <td colspan="4">DPH</td> <td colspan="4">DPL</td> </tr> <tr> <td>C)</td> <td colspan="2">RAM bank register</td> <td>P3</td> <td>P2</td> <td>P1</td> <td>P0</td> <td colspan="2"></td> </tr> <tr> <td>D)</td> <td colspan="2">RAM bank register</td> <td>1</td> <td>W2</td> <td>W1</td> <td>W0</td> <td colspan="2"></td> </tr> </table> </div> <p style="margin-left: 20px;"> : Direct specification by an 8-bit operand : When the data pointer flag is set : When one of 16 certain instructions (such as ADDI and ORI) is executed. : For the MRW W,P and MWR P,W instructions </p> <p>Note: In case B, data pointer RAM address specification is illegal if the RAM address specification (the DPH immediate data) has the same value as the RAM bank register (BNK). In this case immediate specification is allowed.</p> <p>Example: If an IPS 10H instruction is executed when the data pointer flag is set, DPH is 5H, DPL is 3 H and the RAM bank register (BNK) is 1H, then the contents of the S port will be written to RAM location 10H.</p> <p>Example: If BNK and DPH differ, then the following operation will be performed. If an IPS 10H instruction is executed when DPF is 1, DPH is 5, DPL is 3 and BNK is 4, then the contents of the S port will be written to RAM location 53H.</p>	A)	P7	P6	P5	P4	P3	P2	P1	P0	B)	DPH				DPL				C)	RAM bank register		P3	P2	P1	P0			D)	RAM bank register		1	W2	W1	W0			Undefined
A)	P7	P6	P5	P4	P3	P2	P1	P0																															
B)	DPH				DPL																																		
C)	RAM bank register		P3	P2	P1	P0																																	
D)	RAM bank register		1	W2	W1	W0																																	
AC	R/W	Accumulator <div style="text-align: center;"> <table border="1" style="margin: auto;"> <tr> <td style="width: 25px;">MSB</td> <td colspan="4"></td> <td style="width: 25px;">LSB</td> </tr> <tr> <td>AC3</td> <td>AC2</td> <td>AC1</td> <td>AC0</td> <td colspan="2"></td> </tr> </table> </div>	MSB					LSB	AC3	AC2	AC1	AC0			Undefined																								
MSB					LSB																																		
AC3	AC2	AC1	AC0																																				
B	R/W	B register <div style="text-align: center;"> <table border="1" style="margin: auto;"> <tr> <td style="width: 25px;">MSB</td> <td colspan="4"></td> <td style="width: 25px;">LSB</td> </tr> <tr> <td>B3</td> <td>B2</td> <td>B1</td> <td>B0</td> <td colspan="2"></td> </tr> </table> </div> <p>This register is used in combination with RAM as a pair for output to the LCD ports and for timer 2, serial counter and data pointer I/O.</p>	MSB					LSB	B3	B2	B1	B0			Undefined																								
MSB					LSB																																		
B3	B2	B1	B0																																				
DP	R/W	Data pointer <div style="text-align: center;"> <table border="1" style="margin: auto;"> <tr> <td style="width: 25px;">MSB</td> <td colspan="8"></td> <td style="width: 25px;">LSB</td> </tr> <tr> <td>DP7</td> <td>DP6</td> <td>DP5</td> <td>DP4</td> <td>DP3</td> <td>DP2</td> <td>DP1</td> <td>DP0</td> <td colspan="2"></td> </tr> <tr> <td colspan="4">DPH</td> <td colspan="4">DPL</td> <td colspan="2"></td> </tr> </table> </div> <p>The data pointer register functions as a data pointer when the data pointer flag (DPF) is set, allowing control of the on-chip RAM.</p>	MSB									LSB	DP7	DP6	DP5	DP4	DP3	DP2	DP1	DP0			DPH				DPL						Undefined						
MSB									LSB																														
DP7	DP6	DP5	DP4	DP3	DP2	DP1	DP0																																
DPH				DPL																																			

Continued on next page.

Continued from preceding page.

Symbol	R/W	Function	Initialization value at reset
STACK	R/W	<p>Stack pointer The stack consists of eight 14-bit registers and thus can be set to a depth of up to eight levels. The stack pointer is incremented by CALL instructions and interrupts, and decremented by RTS, RTSR and POP instructions.</p> <p>P0 to P11: Program counter (PC) DPF: Data pointer flag</p>	01H
BNK	R/W	<p>Bank register The bank register is a 4-bit register that divides RAM (from 00H to FFH) into 16 sections and is used in moving RAM data, immediate operations and setting the data pointer.</p> <p>Example: ADD*_5,10.....If BNK is 6 then the operation performed will be: RAM(65H) + 10 → AC → RAM(65H).</p>	00H
APG	R/W	<p>RAM page flags The RAM page flags consist of 2 bits that allow RAM to be expanded in 256 4-bit pages to a total of 1024 4-bit locations. Note: Pages 2 and 3 cannot be used by the LC587004, LC587006 and LC587008.</p>	00H
TIM TIM1 TIM2	R/W	<p>Timer counters The timers consist of 8-bit down counters. (timer 1 and timer 2) Timer setting is performed in 8-bit units for immediate data. (timer 1 and timer 2) Reading and writing the lower 4 bits of a timer counter is performed through a RAM location. (timer 2 only) Reading and writing the upper 4 bits of a timer counter is performed using the B register. (timer 2 only)</p>	Undefined

Continued on next page.

Continued from preceding page.

Symbol	R/W	Function	Initialization value at reset
SIO	R/W	<p>Serial counter The serial counter is an 8-bit shift register. Reading and writing the lower 4 bits of the serial counter is performed through a RAM location. Reading and writing the upper 4 bits of the serial counter is performed using the B register.</p>	Undefined
OPG	R/W	<p>ROM page flags The ROM page flags consist of 2 bits that allow ROM to be expanded in 2048 16-bit pages to a total of 8063 16-bit locations. In the LC587004 the legal values are 0 and 1, in the LC587006 the legal values are 0 to 2 and in the LC587008 the legal values are 0 to 3. (The operation when an illegal value is used is undefined.)</p>	00H
STS1	R/O	<p>Status register 1 (STS1) Status register 1 is a 4-bit register whose bits are used as shown below.</p>	00H
STS2	R/W	<p>Status register 2 (STS2) Status register 2 is a 4-bit register that is used for serial counter control and state confirmation.</p> <p>ICF: High when the internal clock is used OSELF: High when the SO2 pin is set to the high impedance state (Z). Low when SO2 is set to the CMOS or n-channel open drain state. SIOF: High when used as serial I/O CSTF: High on serial counter start Low during serial counter operation</p>	00H

Continued on next page.

Continued from preceding page.

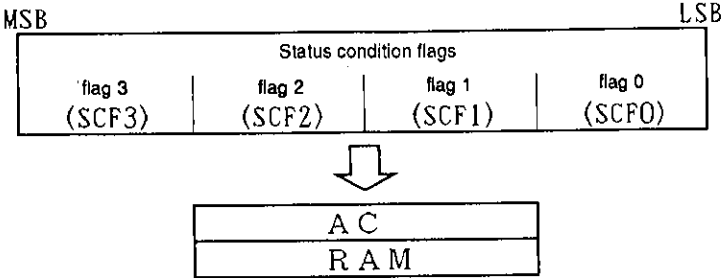
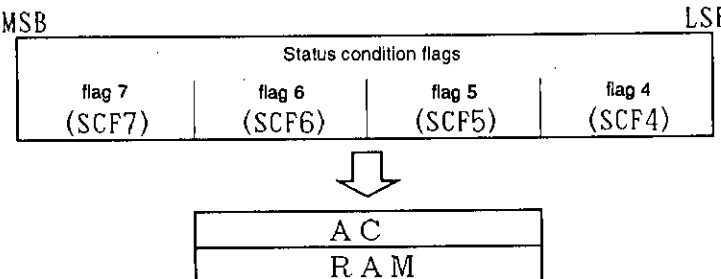
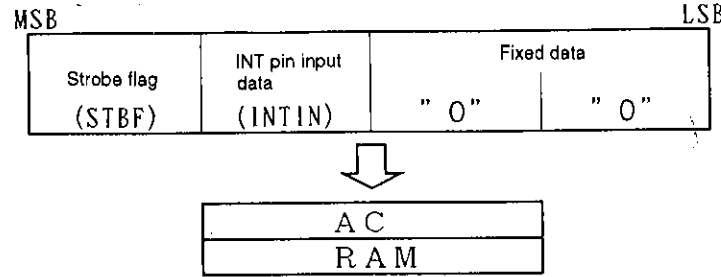
Symbol	R/W	Function	Initialization value at reset
STS3	R/O	<p>Status register 3 (STS3) Status register 3 is a 4-bit register that is used to confirm the HALT and STOP clear conditions.</p> <div style="text-align: center;">  </div> <p>SCF0: Set to 1 if there was a signal change on the INT pin. SCF1: Set to 1 if there was a signal change on the K port. SCF2: Set to 1 if any of the flags in STS4 is set. SCF3: Set to 1 if there was a signal change on the S port. Note: SCF0 is used when enabled by an SF2-1 instruction. SCF1 and SCF3 are used when enabled by an SSW instruction.</p>	00H
STS4	R/O	<p>Status register 4 (STS4) Status register 4 is a 4-bit register that is used to confirm the HALT and STOP clear conditions.</p> <div style="text-align: center;">  </div> <p>SCF4: Divider overflow SCF5: Timer 1 underflow SCF6: Timer 2 underflow SCF7: Serial counter overflow or signal change on SO4</p>	00H
STS5	R/O	<p>Status register 5 (STS5) Status register 5 is a 4-bit register whose bits are used as shown below.</p> <div style="text-align: center;">  </div> <p>Bits 0 and 1: These bits are always 0 and cannot be used. INTIN: Reflects in the input data on the INT pin. STBF: Strobe flag for the segment port (Set to 1 for 00 to 0F and to 0 for 10 to 1E.)</p>	00H

Specifications

The electrical characteristics specified here are provisional and subject to change.

Absolute Maximum Ratings at $V_{SS} = 0\text{ V}$, $T_a = 25^\circ\text{C}$

Parameter	Symbol	Conditions	min	typ	max	Unit	
Maximum supply voltage	V_{DD}		-0.3		+7.0	V	
	V_{DD1}		-0.3		V_{DD}	V	
	V_{DD2}		-0.3		V_{DD}	V	
Maximum input voltage	$V_I(1)$	Allowed in the specified circuit (Figure 1), XTIN, CFIN	Allowed up to the generated voltage				
	$V_I(2)$	S1 to S4, K1 to K4, P1 to P4, SO1 to SO4, A1 to A4, RES, INT, TST, (With the K, P, M, SO and ports in input mode)	-0.3		$V_{DD} + 0.3$	V	
Maximum output voltage	$V_O(1)$	Allowed in the specified circuit (Figure 1), XTOUT, CFOUT	Allowed up to the generated voltage				
	$V_O(2)$	K1 to K4, P1 to P4, SO1 to SO4, A1 to A4, N1 to N4, CUP1, CUP2, Seg1 to Seg35, COM1 to COM4 (With the K, P, M, SO and A ports in output mode)	-0.3		$V_{DD} + 0.3$	V	
	$V_O(3)$	Open drain specifications, N1 to N4 (N ch)	-0.3		+13	V	
Output pin current	$I_O(1)$	Per pin	N1 to N4	0		+15	mA
	$I_O(2)$			-10		0	mA
	$I_O(3)$	K1 to K4, P1 to P4, M1 to M4, SO1 to SO4, A1 to A4	0		5	mA	
	$I_O(4)$		-5		0	mA	
	$\Sigma I_O(1)$	Total current for all pins	K1 to K4, P1 to P4, M1 to M4, SO1 to SO4, A1 to A4, N1 to N4, Seg1 to Seg35			70	mA
	$\Sigma I_O(2)$			-70			mA
Allowable power dissipation	$P_d\text{ max}$	QIP80 flat package			500	mW	
Operating temperature	T_{opr}		-30		+70	$^\circ\text{C}$	
Storage temperature	T_{stg}		-55		+125	$^\circ\text{C}$	

Allowable Operating Ranges at $V_{SS} = 0\text{ V}$, $T_a = -30\text{ to }+70^\circ\text{C}$

Parameter	Symbol	Conditions	min	typ	max	Unit	
Supply voltage	V_{DD}	LCD unused specifications: $V_{DD1} = V_{DD2} = V_{DD}$	2.0		6.0	V	
		Static specifications: $V_{DD1} = V_{DD2} = V_{DD}$	2.0		6.0	V	
		1/2 bias specifications: $V_{DD1} = V_{DD2} = 2 \times 1/2 V_{DD}$	2.8		6.0	V	
		1/3 bias specifications: $V_{DD1} = 2 \times 1/3 V_{DD}$, $V_{DD2} = 1/3 V_{DD}$	2.8		6.0	V	
Hold supply voltage	V_{HD}	Voltage required to hold the contents of RAM and the registers*	2.0		V_{DD}	V	
Input high level voltage	V_{IH1}	S1 to S4, K1 to K4, P1 to P4, M1 to M4, SO1 to SO4, A1 to A4, INT, (With the K, P, M, SO and ports in input mode)	0.7 V_{DD}		V_{DD}	V	
Input low level voltage	V_{IL1}		0		0.3 V_{DD}	V	
Input high level voltage	V_{IH2}	RES pin	0.75 V_{DD}		V_{DD}	V	
Input low level voltage	V_{IL2}		0		0.25 V_{DD}	V	
Input high level voltage	V_{IH3}	CFIN pin	0.75 V_{DD}		V_{DD}	V	
Input low level voltage	V_{IL3}		0		0.25 V_{DD}	V	
Operating frequency 1	fopg1	$V_{DD} = 2.0\text{ to }6.0\text{ V}$, 32 kHz	XTIN/XTOUT crystal oscillator	32		33	kHz
Operating frequency 2	fopg2	$V_{DD} = 2.2\text{ to }6.0\text{ V}$, 38 kHz		37		39	kHz
Operating frequency 3	fopg3	$V_{DD} = 2.2\text{ to }6.0\text{ V}$, 65 kHz		60		70	kHz
Operating frequency 4	fopg4	$V_{DD} = 2.2\text{ to }6.0\text{ V}$	CFIN/CFOUT CF specifications	190		810	kHz
Operating frequency 5	fopg5	$V_{DD} = 2.5\text{ to }6.0\text{ V}$		190		1200	kHz
Operating frequency 6	fopg6	$V_{DD} = 2.5\text{ to }6.0\text{ V}$		190		2300	kHz
Operating frequency 7	fopg7	$V_{DD} = 2.8\text{ to }6.0\text{ V}$		190		4200	kHz
Operating frequency 8	fopg8	$V_{DD} = 4.0\text{ to }6.0\text{ V}$, CFIN/CFOUT RC specifications	100		1500	kHz	
Operating frequency 9	fopg9	$V_{DD} = 2.0\text{ to }6.0\text{ V}$, CFIN/CFOUT EXT specifications	190		800	kHz	
Operating frequency 10	fopg10	$V_{DD} = 3.0\text{ to }6.0\text{ V}$, O1/SO3 pins (in serial mode), Rising and falling edges on the input signals and clock waveform of the SO1/SO3 pins (in serial mode) must be 10 μs or less.	DC		200	kHz	

Note: In the state where the CF/RC oscillator and/or the crystal oscillator are completely stopped and the internal circuits are completely stopped.

Electrical Characteristics at $V_{DD} = 2.5$ to 3.2 V, $V_{SS} = 0$ V, $T_a = -30$ to $+70^\circ\text{C}$

Parameter	Symbol	Conditions	min	typ	max	Unit	
Input resistance	$R_{IN1 A}$	$V_{IN} = 0.2 V_{DD}$, low level hold transistor* Figure 2	60	300	1200	$k\Omega$	
	$R_{IN1 B}$	$V_{IN} = V_{DD}$, pull-down resistor* Figure 2	30	150	500	$k\Omega$	
	$R_{IN1 C}$	$V_{IN} = 0.8 V_{DD}$, high level hold transistor* Figure 2	60	300	1200	$k\Omega$	
	$R_{IN1 D}$	$V_{IN} = V_{SS}$, pull-up resistor* Figure 2	30	150	500	$k\Omega$	
	$R_{IN2 A}$	$V_{IN} = 0.2 V_{DD}$, the INT pin low level hold transistor	60	300	1200	$k\Omega$	
	$R_{IN2 B}$	$V_{IN} = V_{DD}$, The INT pin pull-down resistor	300	1500	5000	$k\Omega$	
	$R_{IN2 C}$	$V_{IN} = 0.8 V_{DD}$, the INT pin high level hold transistor	60	300	1200	$k\Omega$	
	$R_{IN2 D}$	$V_{IN} = V_{SS}$, the INT pin pull-up resistor	300	1500	5000	$k\Omega$	
	R_{IN3}	$V_{IN} = V_{DD}$, the RES pin pull-down resistor	10	30	50	$k\Omega$	
	R_{IN4}	$V_{IN} = V_{SS}$, the RES pin pull-up resistor	10	30	50	$k\Omega$	
	R_{IN5}	$V_{IN} = V_{DD}$, the TST pin pull-down resistor	60	250	1000	$k\Omega$	
	$R_{IN1 A}$	$V_{IN} = 0.2 V_{DD}$, low level hold transistor* Figure 2	$V_{DD} = 2.5$ V	80	300	1200	$k\Omega$
	$R_{IN1 B}$	$V_{IN} = V_{DD}$, pull-down resistor* Figure 2		40	150	500	$k\Omega$
	$R_{IN1 C}$	$V_{IN} = 0.8 V_{DD}$, high level hold transistor* Figure 2		80	300	1200	$k\Omega$
	$R_{IN1 D}$	$V_{IN} = V_{SS}$, pull-up resistor* Figure 2		40	150	500	$k\Omega$
	$R_{IN2 A}$	$V_{IN} = 0.2 V_{DD}$, the INT pin low level hold transistor		80	300	1200	$k\Omega$
	$R_{IN2 B}$	$V_{IN} = V_{DD}$, the INT pin pull-down resistor		400	1500	5000	$k\Omega$
	$R_{IN2 C}$	$V_{IN} = 0.8 V_{DD}$, the INT pin high level hold transistor		80	300	1200	$k\Omega$
	$R_{IN2 D}$	$V_{IN} = V_{SS}$, the INT pin pull-up resistor		400	1500	5000	$k\Omega$
	R_{IN3}	$V_{IN} = V_{DD}$, the RES pin pull-down resistor		10	30	50	$k\Omega$
R_{IN4}	$V_{IN} = V_{SS}$, the RES pin pull-up resistor	10		30	50	$k\Omega$	
R_{IN5}	$V_{IN} = V_{DD}$, the TST pin pull-down resistor	80		250	1000	$k\Omega$	
Output high level voltage	$V_{OH} (1)$	$I_{OH} = -500 \mu\text{A}$		N1 to N4		$V_{DD} - 0.5$	V
Output low level voltage	$V_{OL} (1)$	$I_{OL} = 1.0 \text{ mA}$				0.5	V
Output high level voltage	$V_{OH} (2)$	$I_{OH} = -400 \mu\text{A}$		K1 to K4, P1 to P4, M1 to M4, SO1 to SO4, A1 to A4 (with the K, P, M, SO and A ports in output mode)		$V_{DD} - 0.5$	V
Output low level voltage	$V_{OL} (2)$	$I_{OL} = 400 \mu\text{A}$			0.5	V	
Output off leakage current	$ I_{OFF} $	$V_{OH} = 10.5 \text{ V}$	N1 to 4 (open specifications), Figure 10		1.0	μA	
Segment port output impedances [In CMOS output port mode]							
Output high level voltage	$V_{OH} (3)$	$I_{OH} = -100 \mu\text{A}$	Seg1 to Seg35		$V_{DD} - 0.5$	V	
Output low level voltage	$V_{OL} (3)$	$I_{OL} = 100 \mu\text{A}$			0.5	V	
[In p-channel open-drain output port mode (See Figure 11.)]							
Output high level voltage	$V_{OH} (3)$	$I_{OH} = -100 \mu\text{A}$	Seg1 to Seg35		$V_{DD} - 0.5$	V	
Output off leakage current	$ I_{OFF} $	$V_{OL} = V_{SS}$			1.0	μA	
[In n-channel open-drain output port mode (See Figure 11.)]							
Output low level voltage	$V_{OL} (3)$	$I_{OL} = 100 \mu\text{A}$	Seg1 to Seg35		0.5	V	
Output off leakage current	$ I_{OFF} $	$V_{OH} = V_{DD}$			1.0	μA	
[Static drive]							
Output high level voltage	$V_{OH} (4)$	$I_{OH} = -20 \mu\text{A}$, Seg1 to Seg35			$V_{DD} - 0.2$	V	
Output low level voltage	$V_{OL} (4)$	$I_{OL} = 20 \mu\text{A}$			0.2	V	
Output high level voltage	$V_{OH} (5)$	$I_{OH} = -100 \mu\text{A}$, COM1			$V_{DD} - 0.2$	V	
Output low level voltage	$V_{OL} (5)$	$I_{OL} = 100 \mu\text{A}$			0.2	V	

Note: For the 24 pins S1 to S4, K1 to K4, P1 to P4, M1 to M4, SO1 to SO4 and A1 to A4.

Electrical Characteristics at $V_{DD} = 3.0$ to 4.5 V, $V_{SS} = 0$ V, $T_a = -30$ to $+70^\circ\text{C}$

Parameter	Symbol	Conditions	min	typ	max	Unit	
Input resistance	$R_{IN1 A}$	$V_{IN} = 0.2 V_{DD}$, low level hold transistor* Figure 2	35	200	800	$k\Omega$	
	$R_{IN1 B}$	$V_{IN} = V_{DD}$, pull-down resistor* Figure 2	15	80	300	$k\Omega$	
	$R_{IN1 C}$	$V_{IN} = 0.8 V_{DD}$, high level hold transistor* Figure 2	35	200	800	$k\Omega$	
	$R_{IN1 D}$	$V_{IN} = V_{SS}$, pull-up resistor* Figure 2	15	80	300	$k\Omega$	
	$R_{IN2 A}$	$V_{IN} = 0.2 V_{DD}$, the INT pin low level hold transistor	35	200	800	$k\Omega$	
	$R_{IN2 B}$	$V_{IN} = V_{DD}$, The INT pin pull-down resistor	150	800	3000	$k\Omega$	
	$R_{IN2 C}$	$V_{IN} = 0.8 V_{DD}$, the INT pin high level hold transistor	35	200	800	$k\Omega$	
	$R_{IN2 D}$	$V_{IN} = V_{SS}$, the INT pin pull-up resistor	150	800	3000	$k\Omega$	
	R_{IN3}	$V_{IN} = V_{DD}$, the RES pin pull-down resistor	10	30	50	$k\Omega$	
	R_{IN4}	$V_{IN} = V_{SS}$, the RES pin pull-up resistor	10	30	50	$k\Omega$	
	R_{IN5}	$V_{IN} = V_{DD}$, the TST pin pull-down resistor	25	130	500	$k\Omega$	
	$R_{IN1 A}$	$V_{IN} = 0.2 V_{DD}$, low level hold transistor* Figure 2	$V_{DD} = 3.0$ to 4.0 V	40	200	800	$k\Omega$
	$R_{IN1 B}$	$V_{IN} = V_{DD}$, pull-down resistor* Figure 2		20	80	300	$k\Omega$
	$R_{IN1 C}$	$V_{IN} = 0.8 V_{DD}$, high level hold transistor* Figure 2		40	200	800	$k\Omega$
	$R_{IN1 D}$	$V_{IN} = V_{SS}$, pull-up resistor* Figure 2		20	80	300	$k\Omega$
	$R_{IN2 A}$	$V_{IN} = 0.2 V_{DD}$, the INT pin low level hold transistor		40	300	800	$k\Omega$
	$R_{IN2 B}$	$V_{IN} = V_{DD}$, the INT pin pull-down resistor		200	800	3000	$k\Omega$
	$R_{IN2 C}$	$V_{IN} = 0.8 V_{DD}$, the INT pin high level hold transistor		40	200	1200	$k\Omega$
	$R_{IN2 D}$	$V_{IN} = V_{SS}$, the INT pin pull-up resistor		200	800	3000	$k\Omega$
	R_{IN3}	$V_{IN} = V_{DD}$, the RES pin pull-down resistor		10	30	50	$k\Omega$
R_{IN4}	$V_{IN} = V_{SS}$, the RES pin pull-up resistor	10		30	50	$k\Omega$	
R_{IN5}	$V_{IN} = V_{DD}$, the TST pin pull-down resistor	30		130	500	$k\Omega$	
Output high level voltage	$V_{OH} (1)$	$I_{OH} = -500 \mu\text{A}$		N1 to N4		$V_{DD} - 0.5$	V
Output low level voltage	$V_{OL} (1)$	$I_{OL} = 1.0 \text{ mA}$				0.5	V
Output high level voltage	$V_{OH} (2)$	$I_{OH} = -400 \mu\text{A}$		K1 to K4, P1 to P4, M1 to M4, SO1 to SO4, A1 to A4 (with the K, P, M, SO and A ports in output mode)		$V_{DD} - 0.5$	V
Output low level voltage	$V_{OL} (2)$	$I_{OL} = 400 \mu\text{A}$			0.5	V	
Output off leakage current	$ I_{OFF} $	$V_{OH} = 10.5 \text{ V}$	N1 to 4 (open specifications), Figure 10		1.0	μA	
Segment port output impedances							
[In CMOS output port mode]							
Output high level voltage	$V_{OH} (3)$	$I_{OH} = -100 \mu\text{A}$	Seg1 to Seg35		$V_{DD} - 0.5$	V	
Output low level voltage	$V_{OL} (3)$	$I_{OL} = 100 \mu\text{A}$			0.5	V	
[In p-channel open-drain output port mode (See Figure 11.)]							
Output high level voltage	$V_{OH} (3)$	$I_{OH} = -100 \mu\text{A}$	Seg1 to Seg35		$V_{DD} - 0.5$	V	
Output off leakage current	$ I_{OFF} $	$V_{OL} = V_{SS}$			1.0	μA	
[In n-channel open-drain output port mode (See Figure 11.)]							
Output low level voltage	$V_{OL} (3)$	$I_{OL} = 100 \mu\text{A}$	Seg1 to Seg35		0.5	V	
Output off leakage current	$ I_{OFF} $	$V_{OH} = V_{DD}$			1.0	μA	
[Static drive]							
Output high level voltage	$V_{OH} (4)$	$I_{OH} = -20 \mu\text{A}$, Seg1 to Seg35			$V_{DD} - 0.2$	V	
Output low level voltage	$V_{OL} (4)$	$I_{OL} = 20 \mu\text{A}$			0.2	V	
Output high level voltage	$V_{OH} (5)$	$I_{OH} = -100 \mu\text{A}$, COM1			$V_{DD} - 0.2$	V	
Output low level voltage	$V_{OL} (5)$	$I_{OL} = 100 \mu\text{A}$			0.2	V	
[1/2 bias drive]							
Output high level voltage	$V_{OH} (4)$	$I_{OH} = -20 \mu\text{A}$	Seg1 to Seg35		$V_{DD} - 0.2$	0.2 V	
Output low level voltage	$V_{OL} (4)$	$I_{OL} = 20 \mu\text{A}$					
Output high level voltage	$V_{OH} (5)$	$I_{OH} = -100 \mu\text{A}$			$V_{DD} - 0.2$	V	
Output middle level voltage	V_{OM}	$I_{OH} = -100 \mu\text{A}$ $I_{OL} = 100 \mu\text{A}$	COM1 to COM4		$V_{DD}/2 - 0.2$	$V_{DD}/2 + 0.2$ V	
Output low level voltage	$V_{OL} (5)$	$I_{OL} = 100 \mu\text{A}$				0.2 V	

Note: For the 24 pins S1 to S4, K1 to K4, P1 to P4, M1 to M4, SO1 to SO4 and A1 to A4.

Continued on next page.

LC587008, 587006, 587004

Continued from preceding page.

Parameter	Symbol	Conditions	min	typ	max	Unit	
[1/3 bias drive: About 1/10 of the rating for $V_{DD} = 4.5$ to 6.0 V]							
Supply leakage current	$I_{LEK(1)}$	$V_{DD} = 3.0$ V, $T_a = 25^\circ\text{C}$, Figure 3		0.2	1.0	μA	
Supply leakage current	$I_{LEK(2)}$	$V_{DD} = 3.0$ V, $T_a = 50^\circ\text{C}$, Figure 3		1.0	5.0	μA	
Input leakage current	I_{OFF}	$V_{DD} = 3.0$ V	S1 to S4, K1 to K4, P1 to P4, M1 to M4, SO1 to SO4, A1 to A4, INT, RES (with the K, P, M, SO and A ports in input mode, and with open specifications for the INT and RES pins)				
		$V_{IN} = V_{DD}$				1.0	μA
		$V_{IN} = V_{SS}$		-1.0			μA
Output voltage 1	$V_{DD1(1)}$	$V_{DD} = 3.0$ V, $C_1 = C_2 = 0.1$ μF , $V_{DD1} = V_O$, 1/2 bias, fopp = 32.768 kHz, Figure 4	1.3	1.5	1.7	V	
Supply current 1	$ I_{DD} $ 1-1	$V_{DD} = 3.0$ V, $T_a = 25^\circ\text{C}$	Crystal oscillator specifications, crystal: 32 kHz, $C_g = 20$ pF, $C_I = 25$ k Ω , HALT mode, Figure 6, LCD = 1/3 bias		4.0	8.0	μA
	$ I_{DD} $ 1-2	$V_{DD} = 3.0$ V, $T_a = 50^\circ\text{C}$				20	μA
Supply current 2	$ I_{DD} $ 2-1	$V_{DD} = 3.0$ V, $T_a = 25^\circ\text{C}$	Crystal oscillator specifications, crystal: 38 or 65 kHz, $C_g = 10$ pF, $C_I = 25$ k Ω , HALT mode, Figure 6, LCD = 1/3 bias		6.0	10	V
	$ I_{DD} $ 2-2	$V_{DD} = 3.0$ V, $T_a = 50^\circ\text{C}$				30	μA
Supply current 3	$ I_{DD} $ 3-1	$V_{DD} = 3.0$ V, $T_a = 25^\circ\text{C}$	CF oscillator specifications, CF: 400 kHz, $C_{cg} = C_{cd} = 330$ pF, HALT mode, Figure 7		150	300	μA
	$ I_{DD} $ 3-2	$V_{DD} = 3.0$ V, $T_a = 50^\circ\text{C}$				500	μA
Oscillator start voltage	$ V_{STT} $	$T_{STT} \leq 5$ s	Crystal oscillator specifications, using a 32 kHz crystal, $C_g = 20$ pF, $C_I \leq 25$ k Ω , Figure 6			2.2	V
Oscillator hold voltage	$ V_{HOLD} $			2.0		6.0	V
Oscillator start time	$ T_{STT} $	$V_{DD} = 2.2$ V				5	s
Oscillator stability	Δf	$V_{DD} = 2.95$ to 3.05 V				3	ppm
Oscillator start voltage	$ V_{STT} $	$T_{STT} \leq 5$ s	Crystal oscillator specifications, using a 38 or 65 kHz crystal, $X_{Cg} = 10$ pF, $C_I \leq 25$ k Ω , Figure 6			2.4	V
Oscillator hold voltage	$ V_{HOLD} $			2.2		6.0	V
Oscillator start time	$ T_{STT} $	$V_{DD} = 2.4$ V				5	s
Oscillator start voltage	$ V_{STT} $	$T_{STT} \leq 30$ ms	CF oscillator specifications, using a 400 kHz ceramic filter, $C_{cg} = C_{cd} = 330$ pF, Figure 7			2.4	V
Oscillator hold voltage	$ V_{HOLD} $			2.2		6.0	V
Oscillator start time	$ T_{STT} $	$V_{DD} = 2.4$ V				30	ms
Oscillator start voltage	$ V_{STT} $	$T_{STT} \leq 30$ ms	CF oscillator specifications, using an 800 kHz ceramic filter, $C_{cg} = C_{cd} = 220$ pF or 100 pF, Figure 7			2.4	V
Oscillator hold voltage	$ V_{HOLD} $			2.2		6.0	V
Oscillator start time	$ T_{STT} $	$V_{DD} = 2.4$ V				30	ms
Oscillator correction capacitance	C_d	$V_{DD} = 3.0$ V, XTOUT pin (built-in)	16	20	24	pF	

Electrical Characteristics at $V_{DD} = 4.5$ to 6.0 V, $V_{SS} = 0$ V, $T_a = -30$ to $+70^\circ\text{C}$

Parameter	Symbol	Conditions	min	typ	max	Unit	
Input resistance	$R_{IN1 A}$	$V_{IN} = 0.2 V_{DD}$, low level hold transistor* Figure 2	30	120	500	k Ω	
	$R_{IN1 B}$	$V_{IN} = V_{DD}$, pull-down resistor* Figure 2	10	50	200	k Ω	
	$R_{IN1 C}$	$V_{IN} = 0.8 V_{DD}$, high level hold transistor* Figure 2	30	120	500	k Ω	
	$R_{IN1 D}$	$V_{IN} = V_{SS}$, pull-up resistor* Figure 2	10	50	200	k Ω	
	$R_{IN2 A}$	$V_{IN} = 0.2 V_{DD}$, the INT pin low level hold transistor	30	120	500	k Ω	
	$R_{IN2 B}$	$V_{IN} = V_{DD}$, The INT pin pull-down resistor	100	500	2000	k Ω	
	$R_{IN2 C}$	$V_{IN} = 0.8 V_{DD}$, the INT pin high level hold transistor	30	120	500	k Ω	
	$R_{IN2 D}$	$V_{IN} = V_{SS}$, the INT pin pull-up resistor	100	500	2000	k Ω	
	R_{IN3}	$V_{IN} = V_{DD}$, the RES pin pull-down resistor	10	30	50	k Ω	
	R_{IN4}	$V_{IN} = V_{SS}$, the RES pin pull-up resistor	10	30	50	k Ω	
R_{IN5}	$V_{IN} = V_{DD}$, the TST pin pull-down resistor	20	70	300	k Ω		
Output high level voltage	$V_{OH} (1)$	$I_{OH} = -5.0$ mA	N1 to N4	$V_{DD} - 0.5$		V	
Output low level voltage	$V_{OL} (1)$	$I_{OL} = 10.0$ mA		0.5		V	
Output high level voltage	$V_{OH} (2)$	$I_{OH} = -1.0$ mA	K1 to K4, P1 to P4, M1 to M4, SO1 to SO4, A1 to A4 (with the K, P, M, SO and A ports in output mode), N1 to N4 (open specifications) Figure 10	$V_{DD} - 0.5$	$V_{DD} - 0.2$	V	
Output low level voltage	$V_{OL} (2)$	$I_{OL} = 2.0$ mA		0.2	0.5	V	
Output off leakage current	$ I_{OFF} $	$V_{OH} = 10.5$ V		1.0		μA	
Segment port output impedances [In CMOS output port mode]							
Output high level voltage	$V_{OH} (3)$	$I_{OH} = -500$ μA	Seg1 to Seg35	$V_{DD} - 0.5$	$V_{DD} - 0.2$	V	
Output low level voltage	$V_{OL} (3)$	$I_{OL} = 500$ μA		0.5		V	
[In p-channel open-drain output port mode (See Figure 11.)]							
Output high level voltage	$V_{OH} (4)$	$I_{OH} = -500$ μA	Seg1 to Seg35	$V_{DD} - 0.5$	$V_{DD} - 0.2$	V	
Output off leakage current	$ I_{OFF} $	$V_{OL} = V_{SS}$		1.0		μA	
[In N-channel open-drain output port mode (See Figure 11.)]							
Output low level voltage	$V_{OL} (4)$	$I_{OL} = 500$ μA	Seg1 to Seg35	0.2		V	
Output off leakage current	$ I_{OFF} $	$V_{OH} = V_{DD}$		1.0		μA	
[Static drive]							
Output high level voltage	$V_{OH} (4)$	$I_{OH} = -40$ μA	Seg1 to Seg35	$V_{DD} - 0.2$		V	
Output low level voltage	$V_{OL} (4)$	$I_{OL} = 40$ μA		0.2		V	
Output high level voltage	$V_{OH} (6)$	$I_{OH} = -400$ μA	COM1	$V_{DD} - 0.2$		V	
Output low level voltage	$V_{OL} (6)$	$I_{OL} = 400$ μA		0.2		V	
[1/2 bias drive]							
Output high level voltage	$V_{OH} (4)$	$I_{OH} = -40$ μA	Seg1 to Seg35	$V_{DD} - 0.2$		V	
Output low level voltage	$V_{OL} (4)$	$I_{OL} = 40$ μA		0.2		V	
Output high level voltage	$V_{OH} (6)$	$I_{OH} = -400$ μA	COM1 to COM4	$V_{DD} - 0.2$		V	
Output middle level voltage	V_{OM2-1}	$I_{OH} = -400$ μA		$V_{DD}/2 - 0.2$		$V_{DD}/2 + 0.2$	V
		$I_{OL} = 400$ μA				0.2	V
Output low level voltage	$V_{OL} (6)$	$I_{OL} = 400$ μA				0.2	V
[1/3 bias drive]							
Output high level voltage	$V_{OH} (4)$	$I_{OH} = -40$ μA	Seg1 to Seg35	$V_{DD} - 0.2$		V	
Output middle level voltage	V_{OM1-1}	$I_{OH} = -40$ μA		$2 V_{DD}/3 - 0.2$		$2 V_{DD}/3 + 0.2$	V
	V_{OM1-2}	$I_{OL} = 40$ μA		$V_{DD}/3 - 0.2$		$V_{DD}/3 + 0.2$	V
Output low level voltage	$V_{OL} (4)$	$I_{OL} = 40$ μA		0.2		V	
Output high level voltage	$V_{OH} (6)$	$I_{OH} = -400$ μA	COM1 to COM4	$V_{DD} - 0.2$		V	
Output middle level voltage	V_{OM2-1}	$I_{OH} = -400$ μA		$2 V_{DD}/3 - 0.2$		$2 V_{DD}/3 + 0.2$	V
		$I_{OL} = 400$ μA		$V_{DD}/3 - 0.2$		$V_{DD}/3 + 0.2$	V
Output low level voltage	$V_{OL} (6)$	$I_{OL} = 400$ μA		0.2		V	

Note: For the 24 pins S1 to S4, K1 to K4, P1 to P4, M1 to M4, SO1 to SO4 and A1 to A4.

Continued on next page.

Continued from preceding page.

Parameter	Symbol	Conditions	min	typ	max	Unit	
Operating current	I_{OP-1}	$V_{DD} = 3\text{ V}$, $T_a = 25^\circ\text{C}$, 32 kHz crystal oscillator, LCD = 1/3 bias, Figure 6		20	30	μA	
	I_{OP-2}	$V_{DD} = 5\text{ V}$, $T_a = 25^\circ\text{C}$, 32 kHz crystal oscillator, LCD = 1/3 bias, Figure 6		40	60	μA	
	I_{OP-3}	$V_{DD} = 3\text{ V}$, $T_a = 25^\circ\text{C}$, 400 kHz, CF oscillator, Figure 6		240	300	μA	
	I_{OP-4}	$V_{DD} = 5\text{ V}$, $T_a = 25^\circ\text{C}$, 400 kHz, CF oscillator, Figure 6		620	780	μA	
	I_{OP-5}	$V_{DD} = 3\text{ V}$, $T_a = 25^\circ\text{C}$, 1 MHz, CF oscillator, Figure 6		350	480	μA	
	I_{OP-6}	$V_{DD} = 5\text{ V}$, $T_a = 25^\circ\text{C}$, 1 MHz, CF oscillator, Figure 6		850	1200	μA	
	I_{OP-7}	$V_{DD} = 5\text{ V}$, $T_a = 25^\circ\text{C}$, 4 MHz, CF oscillator, Figure 6		1700	2500	μA	
Supply leakage current	$I_{LEK (1)}$	$V_{DD} = 6.0\text{ V}$, $T_a = 25^\circ\text{C}$, Figure 3		0.2	1.0	μA	
Supply leakage current	$I_{LEK (2)}$	$V_{DD} = 6.0\text{ V}$, $T_a = 50^\circ\text{C}$, Figure 3		1.0	5.0	μA	
Input leakage current	I_{OFF}	$V_{DD} = 6.0\text{ V}$	S1 to S4, K1 to K4, M1 to M4, SO1 to SO4, A1 to A4, INT, RES (with the K, P, M, SO and A ports in input mode and with open specifications for the INT and RES pins)			μA	
		$V_{IN} = V_{DD}$				1.0	μA
		$V_{IN} = V_{SS}$		-1.0		μA	
Output voltage 2	$V_{DD1-(2)}$	$V_{DD} = 5.0\text{ V}$, $C_1 = C_2 = 0.1\ \mu\text{F}$, Figure 4, 1/2 bias, $f_{opg} = 32.768\text{ kHz}$	$V_{DD1} = V_O$	2.4	2.5	2.6	V
Output voltage 3	$V_{DD1-(3)}$	$V_{DD} = 5.0\text{ V}$, $C_1 = C_2 = 0.1\ \mu\text{F}$, Figure 4, 1/3 bias, $f_{opg} = 32.768\text{ kHz}$	$V_{DD1} = V_O$	1.4	1.67	1.8	V
	$V_{DD2-(3)}$		$V_{DD2} = V_O$	3.1	3.33	3.5	V
Supply current 1	$ I_{DD} _{1-1}$	$V_{DD} = 5.0\text{ V}$, $T_a = 25^\circ\text{C}$	Crystal oscillator specifications, crystal: 32 kHz $C_g = 20\text{ pF}$, $C_1 = 25\text{ k}\Omega$, HALT mode, Figure 6, LCD = 1/3 bias		15	30	μA
	$ I_{DD} _{1-2}$	$V_{DD} = 5.0\text{ V}$, $T_a = 50^\circ\text{C}$				50	μA
Supply current 2	$ I_{DD} _{2-1}$	$V_{DD} = 5.0\text{ V}$, $T_a = 25^\circ\text{C}$	Crystal oscillator specifications, crystal: 38 or 65 kHz, $C_g = 10\text{ pF}$, $C_1 = 25\text{ k}\Omega$, HALT mode, Figure 6, LCD = 1/3 bias		15	30	μA
	$ I_{DD} _{2-2}$	$V_{DD} = 5.0\text{ V}$, $T_a = 50^\circ\text{C}$				50	μA
Supply current 3	$ I_{DD} _{3-1}$	$V_{DD} = 5.0\text{ V}$, $T_a = 25^\circ\text{C}$	CF oscillator specifications, CF: 400 kHz, $C_{cg} = C_{cd} = 330\text{ pF}$, HALT mode, Figure 7		400	600	μA
	$ I_{DD} _{3-2}$	$V_{DD} = 5.0\text{ V}$, $T_a = 50^\circ\text{C}$				600	μA
Supply current 4	$ I_{DD} _{4-1}$	$V_{DD} = 5.0\text{ V}$, $T_a = 25^\circ\text{C}$	CF oscillator specifications, CF: 1000 kHz, $C_{cg} = C_{cd} = 100\text{ pF}$, HALT mode, Figure 8 or 220 pF		450	650	μA
	$ I_{DD} _{4-2}$	$V_{DD} = 5.0\text{ V}$, $T_a = 50^\circ\text{C}$				700	μA
Supply current 5	$ I_{DD} _{5-1}$	$V_{DD} = 5.0\text{ V}$, $T_a = 25^\circ\text{C}$	CF oscillator specifications, CF: 2000 kHz, $C_{cg} = C_{cd} = 33\text{ pF}$, HALT mode, Figure 8		500	700	μA
	$ I_{DD} _{5-2}$	$V_{DD} = 5.0\text{ V}$, $T_a = 50^\circ\text{C}$				750	μA
Supply current 6	$ I_{DD} _{6-1}$	$V_{DD} = 5.0\text{ V}$, $T_a = 25^\circ\text{C}$	CF oscillator specifications, CF: 4000 kHz, $C_{cg} = C_{cd} = 33\text{ pF}$, HALT mode, Figure 8		700	900	μA
	$ I_{DD} _{6-2}$	$V_{DD} = 5.0\text{ V}$, $T_a = 50^\circ\text{C}$				1000	μA
Oscillator correction capacitance	C_d	$V_{DD} = 5.0\text{ V}$, XTOUT pin (built-in)		16	20	24	pF

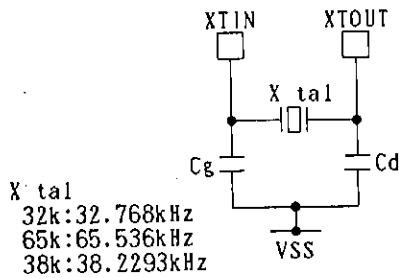

Figure 1-1 Oscillator Circuit (XT pins)

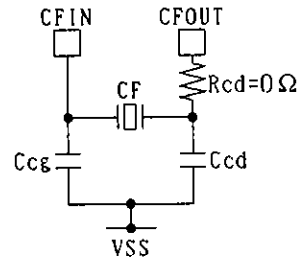

Figure 1-2 Oscillator Circuit (CF pins)

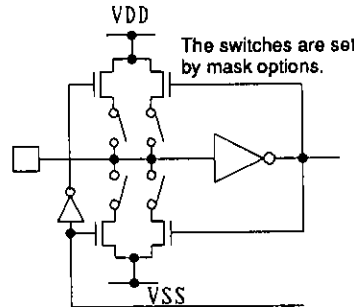

Figure 2 S, K, P, M, SO and A Port Input Circuit Configuration

Recommended Ceramic Filters

Manufacturer	Murata Mfg. Co., Ltd.			Kyocera Corporation			
	Item	Catalog No.	Ccg (pF)	Ccd (pF)	Catalog No.	Ccg (pF)	Ccd (pF)
400 kHz		CSB400P	330	330	KBR-400B	330	330
800 kHz		CSB800J	220	220	KBR-800H	100	100
1 MHz		CSB1000J	220	220	KBR-1000H/Y	100	100
2 MHz		CSA2.00MG, CST2.00MG	33 (built-in)	33 (built-in)	KBR-2.0MS	33	33
4 MHz		CSA4.00MG, CSA4.00MGW	33 (built-in)	33 (built-in)	KBR-4.0MSA/MCA, KBR-4.0MKS/MWS	33 (built-in)	33 (built-in)

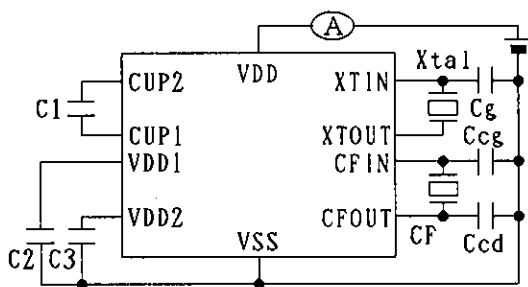

Figure 3 Supply Leakage Test Circuit

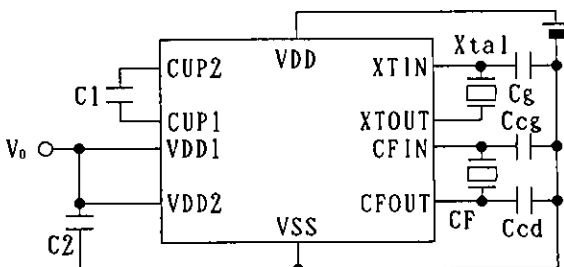

Figure 4 Output Voltage Test Circuit

- Stopped state
- S-port input resistors: on state
- I/O ports: output mode, all data values high
- RES and INT pins: built-in resistor specifications, open state
- Currents due to external components connected to the LCD ports are not included.
- Crystal frequency: between 32 and 65 kHz
- CF frequency: 200 kHz to 4 MHz
- Crystal frequency: 32 kHz
- C1, C2 and C3: 0.1 μF
- LCD ports: open
- CF frequency: 200 kHz to 4 MHz

Figures 4 and 5

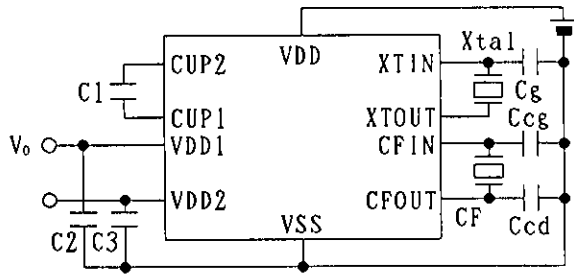
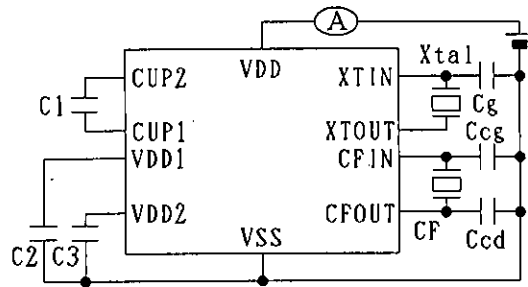

Figure 5 Output Voltage Test Circuit



Note: With the CF oscillator in the stopped state, with a 32, 38 or 65 kHz crystal. C1, C2 and C3 are 0.1 μ F.

Figure 6 Supply Current Test Circuit

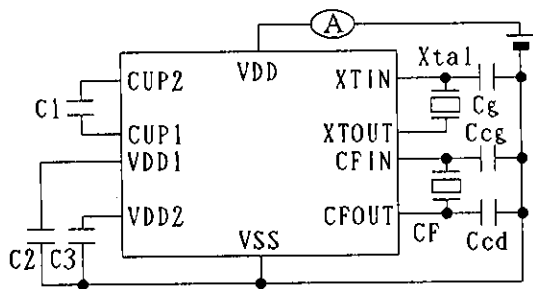
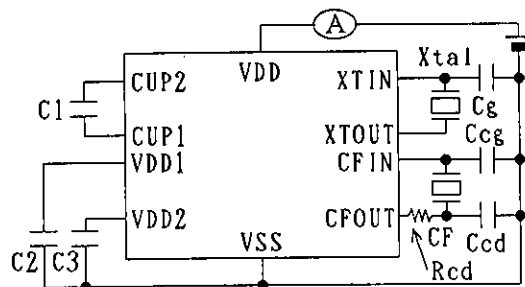
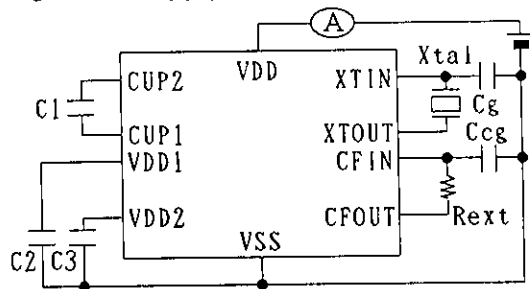

Figure 7 Supply Current Test Circuit



Note: With the crystal oscillator in the stopped state.

Figure 8 Supply Current Test Circuit



Note: With the crystal in the oscillation stopped state

Figure 9 Supply Current Test Circuit

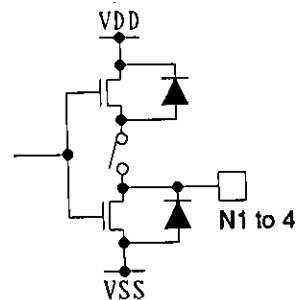

Figure 10 Supply Current Test Circuit

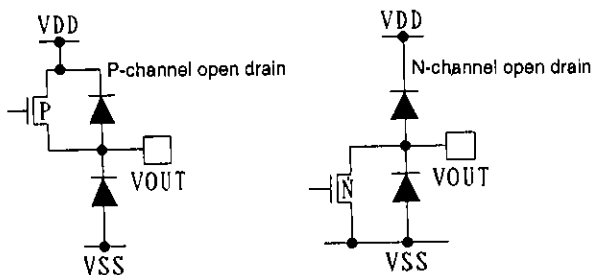

Figure 11 Segment Pin Open Drain Circuit Configurations

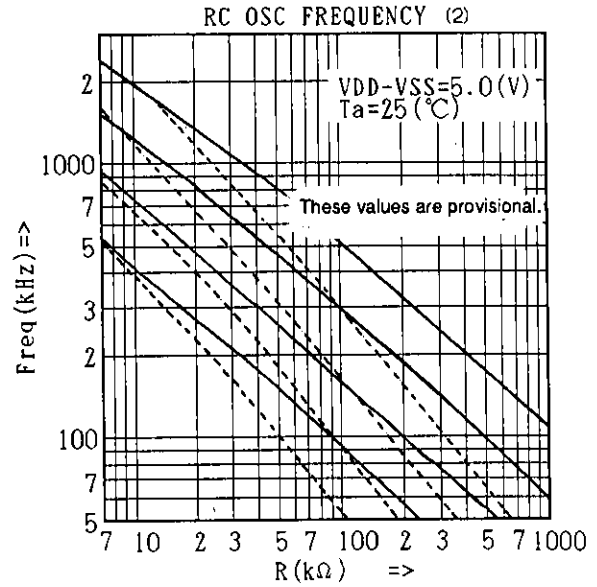
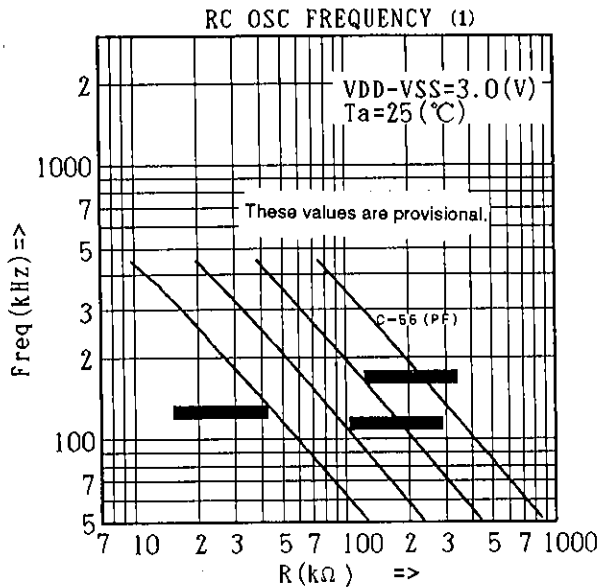

Figure 12 Sample RC Oscillator Frequency Characteristics

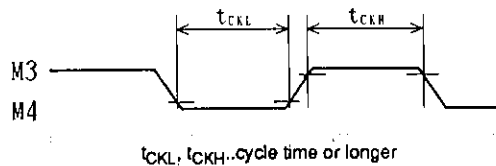
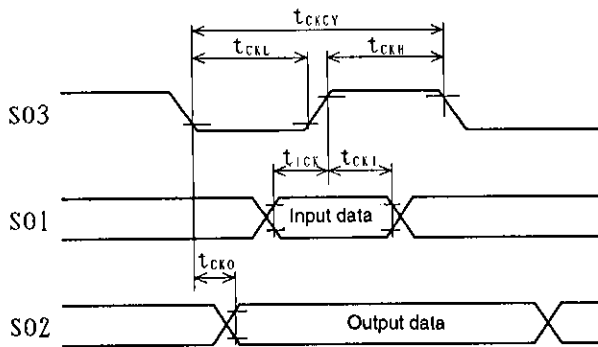

Figure 14 Timer 1 and Timer 2 External Clock Input Timing (external clock mode, pins M3 and M4)

$t_{CKCY} \dots \dots \dots 5 \mu s \text{ MIN}$
 $t_{CKL} = t_{CKH} \dots \dots \dots 2.4 \mu s \text{ MIN}$
 $t_{CKI} \dots \dots \dots 1 \mu s \text{ MIN}$
 $t_{CKO} \dots \dots \dots 1 \mu s \text{ MIN}$
 $t_{CKO} \dots \dots \dots 1 \mu s \text{ MAX}$
 $V_{DD} = 3.0 \text{ to } 6.0 V$

Figure 13 Serial I/O Timing (in external clock mode)

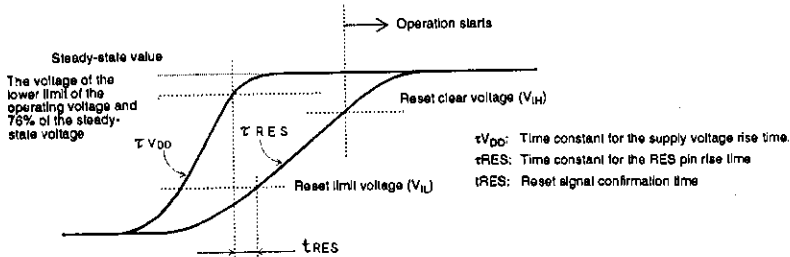
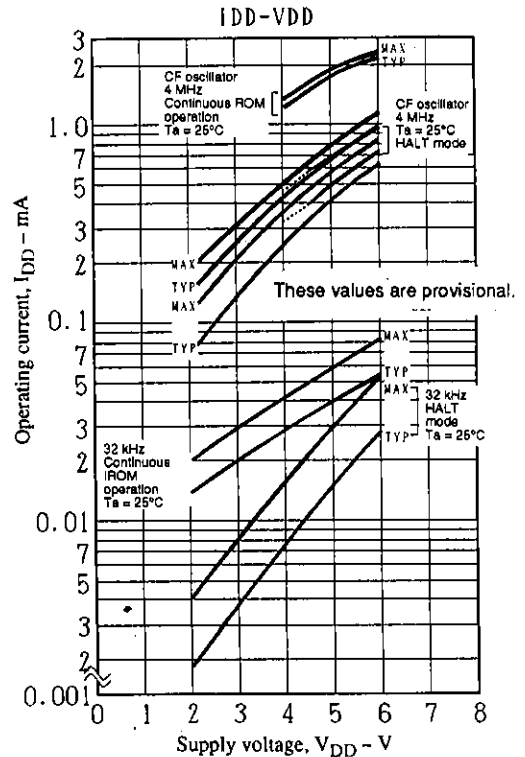

Figure Initial Reset Timing



- No products described or contained herein are intended for use in surgical implants, life-support systems, aerospace equipment, nuclear power control systems, vehicles, disaster/crime-prevention equipment and the like, the failure of which may directly or indirectly cause injury, death or property loss.
- Anyone purchasing any products described or contained herein for an above-mentioned use shall:
 - ① Accept full responsibility and indemnity and defend SANYO ELECTRIC CO., LTD., its affiliates, subsidiaries and distributors and all their officers and employees, jointly and severally, against any and all claims and litigation and all damages, cost and expenses associated with such use:
 - ② Not impose any responsibility for any fault or negligence which may be cited in any such claim or litigation on SANYO ELECTRIC CO., LTD., its affiliates, subsidiaries and distributors or any of their officers and employees jointly or severally.
- Information (including circuit diagrams and circuit parameters) herein is for example only; it is not guaranteed for volume production. SANYO believes information herein is accurate and reliable, but no guarantees are made or implied regarding its use or any infringements of intellectual property rights or other rights of third parties.

This catalog provides information as of June, 1995. Specifications and information herein are subject to change without notice.