

HG62E SERIES

(Hitachi CMOS Gate Array)



The HG62E series is a master slice CMOS gate array of which the gate length is $1\ \mu\text{m}$ and uses 2-layer metal interconnect technology. Auto-diagnosis is a typical feature of HG62E series. This series has twelve master chips with high gate count/pads from 770/68 to 24,020/272. These chips can replace not only CMOS logics but also TTL logics due to the high speed of 0.7 ns typ and compatibility of input and output buffers at TTL/CMOS level.

LSI design is fully automated by the DA (Design Automation) system and custom LSI are developed based on logic diagrams and test patterns from the customer in a short time and with reasonable cost. The engineering workstation method of interface is also available.

■ FEATURES

● Auto-diagnosis

Our DA will generate test circuit and test pattern automatically.

● Fast operation

Internal gate (2-input NAND, FO = 2, AI = 2 mm)

..... 0.7 ns typ

Input buffer (FO = 2, AI = 2 mm) 2.0 ns typ

Output buffer ($C_L = 50\ \text{pF}$) 7.0 ns typ

● Low power dissipation

At 10 MHz operation (internal gate) . . . 200 μW /gate typ

● Flexible input and output configurations

Output can be CMOS/open drain/3-state

Compatibility of input and output buffers at TTL/CMOS level.

Oscillator, Schmitt input, pull-up/down resistors are available.

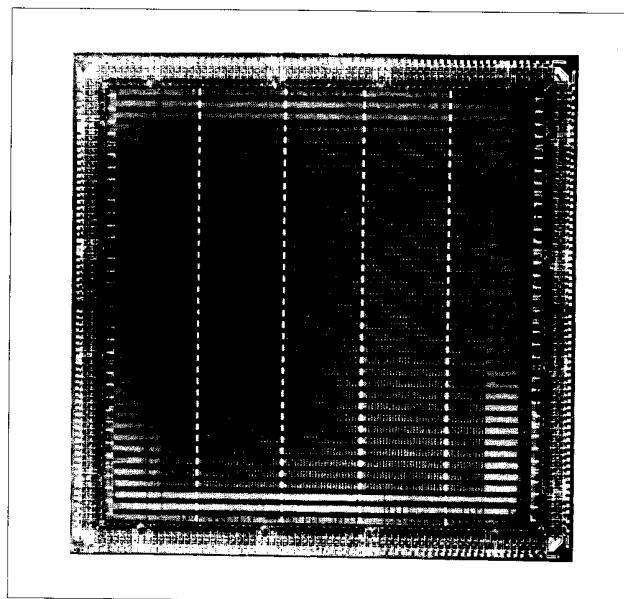

● Wide operation temperature range

-20 to +75°C

● Wide package selection

Especially plastic packages with high pin count

● Powerful design support

Hierarchical design capability

Test pattern evaluation with fault simulator

Auto-generation of test pattern

Designs support at local design center

EWS support available

● Quick turn around time and reasonable development cost

■ LINE UP

		HG62E08	HG62E11	HG62E15	HG62E22	HG62E33
Gate count		770	1162	1515	2178	3297
Max. pad count		68	80	86	102	120
Package type and max. available Signal pin number	DILP-40	○ 38	○ 38	○ 38	○ 38	○ 38
	DILP-64S	⊙ 60	⊙ 60	○ 60	○ 60	○ 60
	QFP-64	○ 60	○ 60	○ 60	○ 60	○ 60
	QFP-80		○ 76	○ 76	○ 76	○ 76
	QFP-100			○ 82	○ 96	○ 96
	QFP3-64	○ 60	○ 60	○ 60	○ 60	○ 60
	QFP3-80		○ 76	○ 76	○ 76	○ 76
	QFP5-136					○ 112
	PLCC-44	○ 40				
	PLCC-68	⊙ 64	⊙ 64	⊙ 64	⊙ 64	⊙ 64
PLCC-84			△	△	△	

		HG62E43	HG62E58	HG62E75	HG62E101	HG62E130	HG62E182	HG62E240
Gate count		4309	5821	7488	10076	13015	18176	24020
Max. pad count		100	118	138	162	190	230	272
Package type and max.* available Signal pin number	DILP-40	○ 38	○ 38	○ 38				
	DILP-64S	○ 60	○ 60	○ 60	○ 60	○ 60		
	QFP-64	○ 60	○ 60	○ 60				
	QFP-80	○ 76	○ 76	○ 76	○ 76			
	QFP-100	○ 96	○ 96	○ 96	○ 96			
	QFP5-136		○ 110	○ 128	○ 128	○ 128		
	QFP5-168				○ 146	○ 152		
	QFP5-208						○ 188	
	PLCC-68	⊙ 64	○ 64	○ 64	○ 64	○ 64		
	PLCC-84	○ 80	○ 80	△	△			
	PGA-135			○ 127	○ 127			
	PGA-179				○ 146	○ 163		
PGA-240						○ 198	○ 208	

*Includes output dedicated pin (max. 8)

Notes QFP: QFP1420 (EIAJ)
 QFP3: QFP1414 (EIAJ)
 QFP5: QFP2828 (EIAJ)

△ : Under development

⊙ : Applicable for wide-temperature range
 (Ta = -40 ~ +85°C)

■ ABSOLUTE MAXIMUM RATINGS

Item	Symbol	Rating	Unit
Supply Voltage	V_{CC}	-0.3 to +6.7	V
Terminal Voltage	Input	V_{TI}	-0.3 to +6.7
	Output	V_{TO}	-0.3 to $V_{CC}+0.3$
Output Current	per one output	I_O	-16 to +16
	per one V_{CC} -GND	I_{OT}	-70 to +70
Operating Temperature	T_{opr}	-20 to +75	°C
Storage Temperature	with Bias	T_{bias}	-20 to +85
	without Bias	T_{stg}	-55 to +125

■ ELECTRICAL CHARACTERISTICS ($V_{CC} = 5V \pm 5\%$, $T_a = -20$ to $+75^\circ\text{C}$)

Item	Symbol	Test Conditions	min.	typ.	max.	Unit	
Input Voltage (TTL Level)	V_{IHT}		2.2	–	$V_{CC} + 0.3$	V	
	V_{ILT}		–0.3	–	0.8	V	
Input Voltage (CMOS Level)	V_{IHC}		$0.7 \times V_{CC}$	–	$V_{CC} + 0.3$	V	
	V_{ILC}		–0.3	–	$0.3 \times V_{CC}$	V	
Schmitt Trigger (TTL Level)	V_{TT}^+	$V_{CC} = 5\text{ V}$	1.5	–	2.5	V	
	V_{TT}^-	$V_{CC} = 5\text{ V}$	0.5	–	1.5	V	
	ΔV_{TT}	$V_{CC} = 5\text{ V}$	0.3	–	–	V	
Schmitt Trigger (CMOS Level)	V_{TC}^+	$V_{CC} = 5\text{ V}$	2.8	–	4.0	V	
	V_{TC}^-	$V_{CC} = 5\text{ V}$	1.2	–	2.4	V	
	ΔV_{TC}	$V_{CC} = 5\text{ V}$	0.3	–	–	V	
Output Voltage	V_{OH}	$I_{OH} = -2\text{ mA}$	3.5	–	–	V	
	V_{OL}	$I_{OL} = 8\text{ mA}$	–	–	0.5	V	
Input Leakage Current	I_{LI}		–	–	1	μA	
Output Leakage Current	I_{LO}	at high impedance	–	–	1	μA	
Pull-up Current	I_{PU}	$V_{IN} = \text{GND}$	80	220	550	μA	
Pull-down Current	I_{PD}	$V_{IN} = V_{CC}$	80	220	550	μA	
Gate Delay	Internal	t_{pd}	2 input NAND, FO = 2, A ℓ = 2 mm	–	0.7	–	ns
	Input Buffer	t_{pd}	FO = 2, A ℓ = 2mm	–	2.0	–	ns
	Output Buffer	t_{pd}	$C_L = 50\text{ pF}$	–	7.0	–	ns
Power Dissipation	I_{CC}	Internal 2 input NAND at 10 MHz	–	40	–	$\mu\text{A}/\text{Gate}$	

■ TERMINAL CAPACITANCE ($T_a = 25^\circ\text{C}$, $f = 1\text{ MHz}$)

Item	Symbol	Test Conditions	min.	typ.	max.	Unit
Terminal Capacitance	C_T	$V_{in} = 0\text{ V}$	–	–	12.5	pF

* This parameter is sampled and not 100% tested.

■ DEVELOPMENT FLOW

Development flow of gate arrays is shown below. Logic design and test patterns development are done by users. These are fed to a computer which performs logic simulation. The machine drawn logic diagram is checked by the user. After the logic simulation and timing rule check, fault simulation is performed with test patterns designed by user to verify logic design. Auto-diagnosis detects the faults which fault simulation could not find. Then automatic layout and delay check of critical path are performed. After these design check, PG tape and test tape are generated. Sample production takes very short time because it needs only metal wiring on inventory wafers.

Finished wafers are probed with following two test patterns,

of users design and auto-generation, then assembled, tested again and shipped.

There are two standard interfaces between a user and Hitachi, Namely:

(1) Logic diagram interface

The user supplies logic diagram and test patterns to Hitachi. Further jobs are done by Hitachi except for some confirmation by the user.

(2) Logic file interface

The user performs simulations by himself on his EWS, simulator or Hitachi's terminal for design. Then the user supplies Hitachi with complete logic file. Our engineers are willing to support the customer.

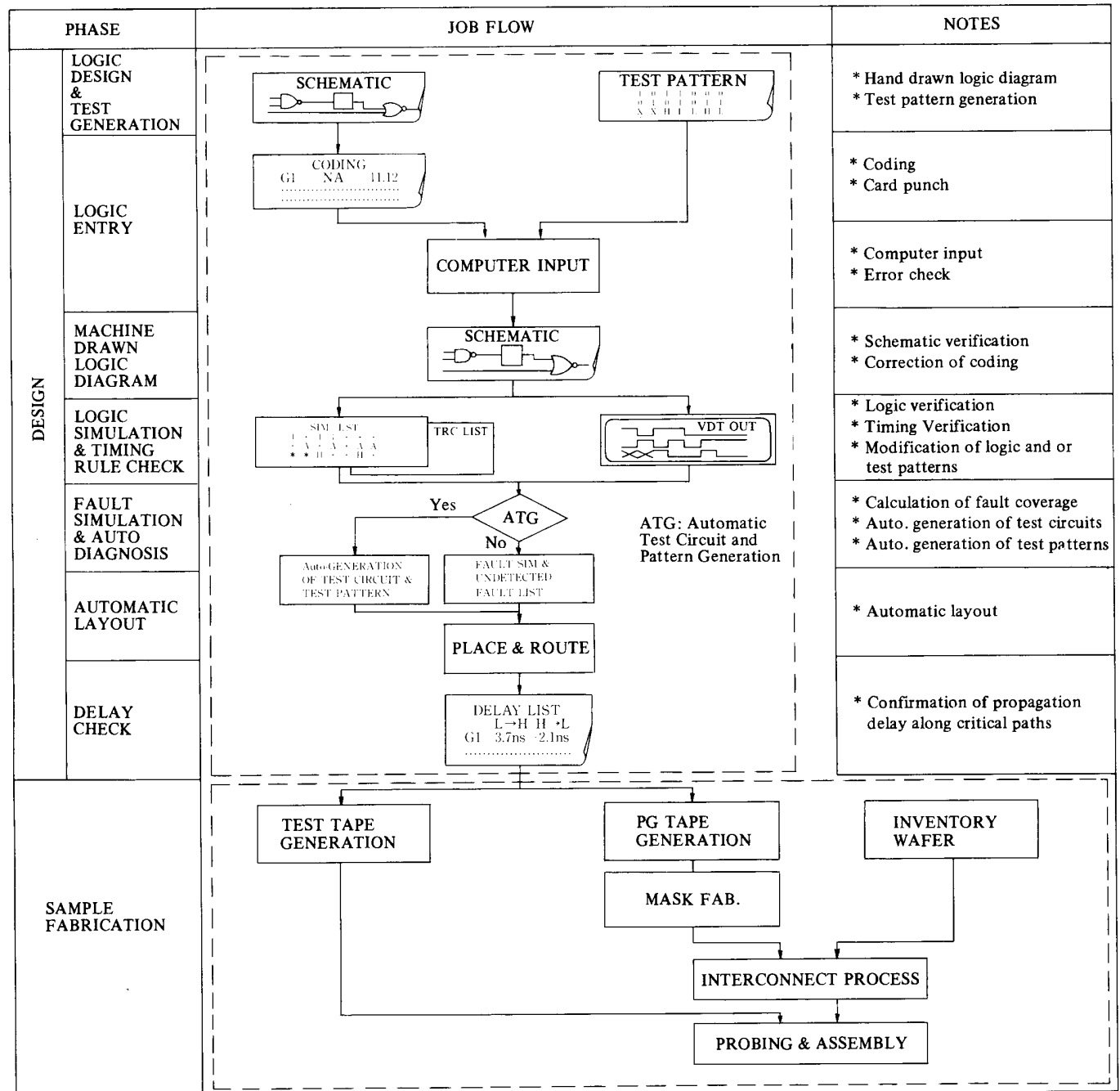

■ AUTO-DIAGNOSIS

Following is a schematic diagram of auto-diagnosis using scan bus. Auto-diagnosis requires such signals as address and scan bus assigned to flip-flop, read/write line, test clock etc. Diagnosis control circuit including address decoder controls these signals. Normal pin can be used as the pin of address and scan bus. Two test dedicated pins are required to control

the test control circuit. Use flip-flops with scan (read/write) function, which consist of master part (performs normal functions) and slave part (latches data for a time). When you design logic, it is not necessary to take the circuits mentioned before into consideration.

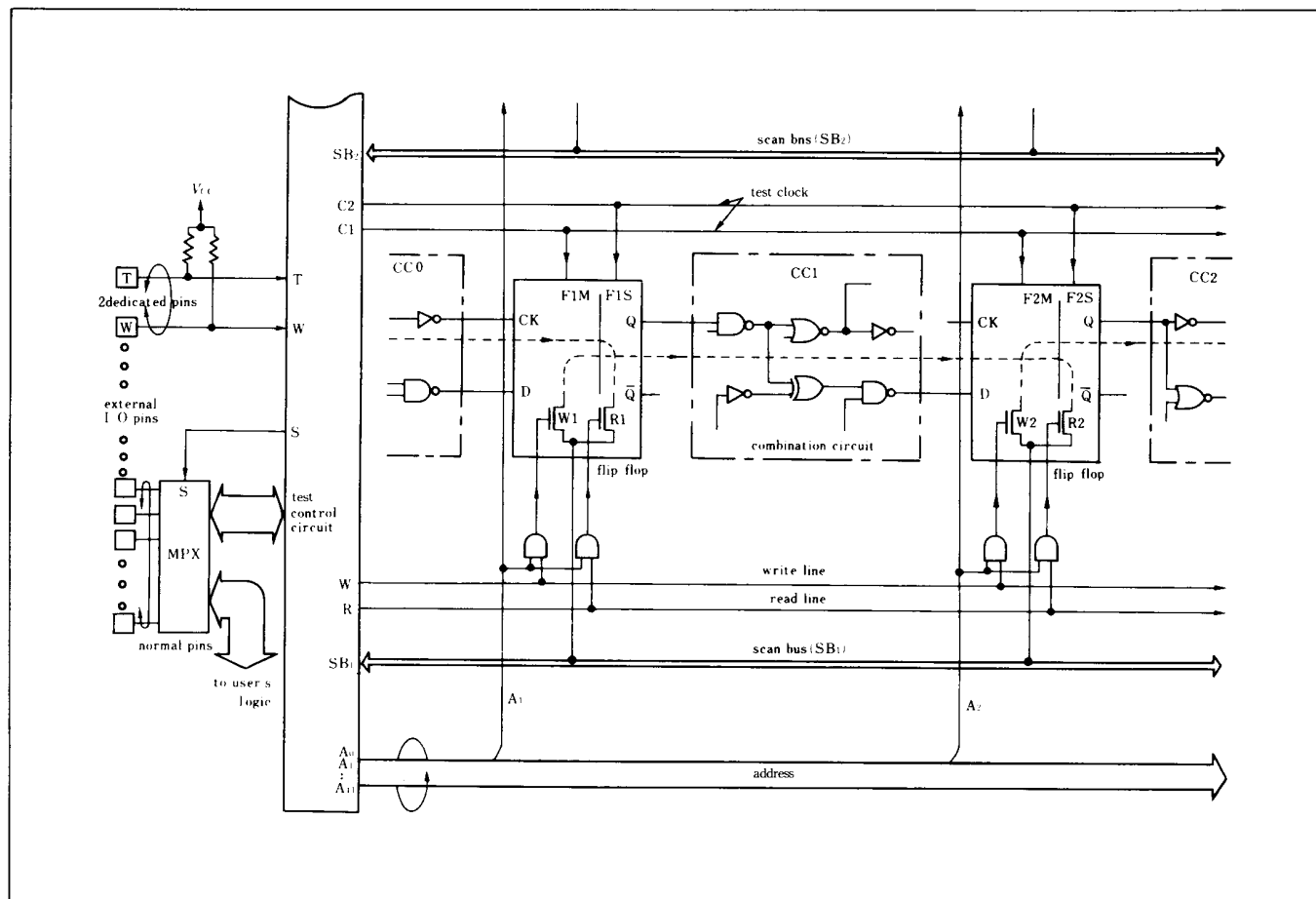

The algorithm of combination circuit is not so complex, it is possible to generate high fault coverage of test patterns. But if the circuit includes flip-flops, it is difficult to get high fault coverage. Entire circuit is partitioned into combination circuits separated by flip-flops. Flip-flops are regarded as I/O terminals using scan bus. DA will generate the test patterns of every combination circuit separated by flip-flops.

● Procedure

(1) Auto-generation of test circuit

DA system will generate all test circuits; test control circuit, multiplexer, address, scan bus and clock after the logic verification by simulation.

(2) Auto-generation of test patterns

DA system will generate test patterns. The following is an example of testing combination circuit CC1 in the diagram.

- ① Scan in the data for CC1 testing at the slave side of flip-flop. Select address A1, then data is transmitted by the route of external I/O Pin → Scan bus (SB1) → W1 → F1M → F1S.
- ② The data passed CC1 is transmitted to flip-flop. The circuit becomes normal operation mode and the data is transmitted by the route of F1S → CC1 → F2M.
- ③ The data in flip-flop is scanned out on external I/O Pin. Select address A2, then data is transmitted by the route of F2M → F2S → SB1 → external I/O Pin.

Apply these procedure to generate high fault coverage of test patterns based on the fault detection algorithm of combination circuit.

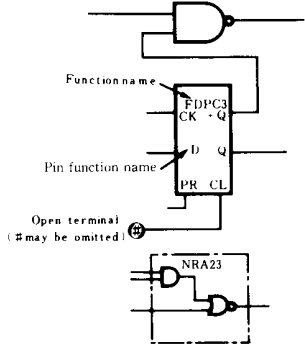
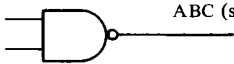
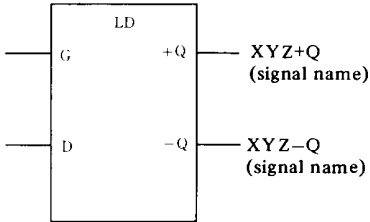
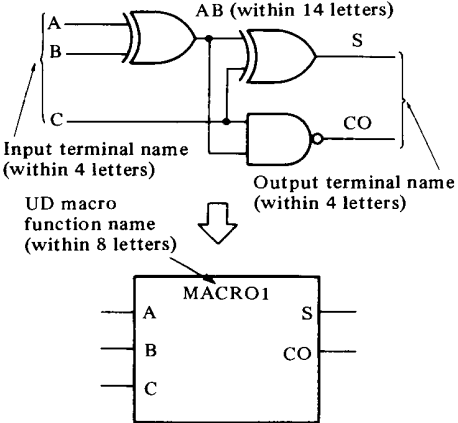
No.	Item	Rules	Examples										
1.	Forms	Size A-3 forms supplied by Hitachi											
2.	Logic symbol	<p>(1) Draw logic diagram with exactly the same symbols as shown in Macrocell Library including function name, terminal name and the size.</p> <p>(2) The internal symbol surrounded by dotted line can be omitted but macro function name must be described and the position of terminal can not be changed instead.</p> <p>(3) The template shall be provided.</p> <p>(4) 3-state gate will occupy 2 blocks in the drawing form.</p>											
3.	Characters	<p>(1) 2 to 3mm higher or larger alphabets, +, -, 0 to 9 in total 38 characters.</p> <p>(2) The letters shown in the table must be written as in the bottom column.</p>	<table border="1" data-bbox="1078 772 1459 842"> <tr> <td>Alphabet</td> <td>I</td> <td>J</td> <td>O</td> <td>U</td> </tr> <tr> <td>Script</td> <td>i</td> <td>j</td> <td>o</td> <td>u</td> </tr> </table>	Alphabet	I	J	O	U	Script	i	j	o	u
Alphabet	I	J	O	U									
Script	i	j	o	u									
4.	Signal/element name	<p>(1) Give name all LSI pins within 8 letters.</p> <p>(2) Give name elements and internal signals within 14 letters. You can use different names for element and its output signal.</p> <p>For easy reference of signal name,</p> <p>(a) Use same name for a element and its output when it has only one output signal.</p> <p>(b) For the output signal names, use the combined names of element and its output terminals, when it has two or more output terminals.</p> <p>(c) It is easier to name a macrocell by using its location and page number of logic diagram.</p>	<p>ABC (element name)</p>  <p>XYZ (element name)</p> 										
5.	Hierarchical design	<p>The user can define his own macrocell as block (UD macro) and also can define blocks within the block.</p> <p>(1) Give name to the macrocells which composes UD macro within 14 letters.</p> <p>(2) Name input and output terminals of UD macro within 4 letters.</p> <p>(3) Give functional name to UD macro within 8 letters. Don't use letter '-' (minus) in the UD macro name.</p> <p>(4) For the symbol size of a UD macro, the width is the 'A' size of the template. Hight can be determined in proportion to the number of input or output terminals.</p>											

(to be continued)

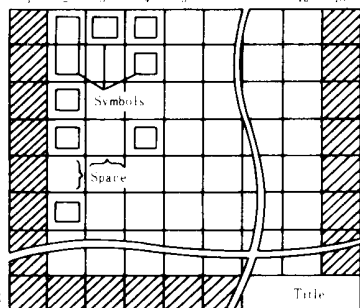
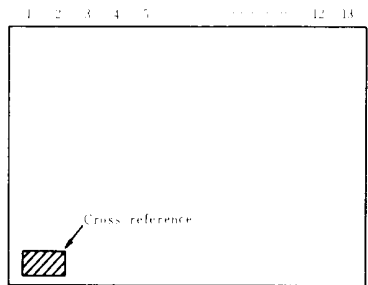
No.	Item	Rules	Examples
		<p>Now, UD-macro can be used in a same way as macrocells in cell library. For users' convenience it is recommended to give element or signal names 8 letters or less. User has to deal with the longer names proportion to the depth of hierarchical level in the simulation.</p>	
6.	Signal line	<p>(1) LSI input/output signal must be shown by and LSI pin number in []. (2) Up to three lines can be connected to one junction point</p>	
7.	Symbol layout	<p>(1) A signal should flow from left to right. (2) No symbol is allowed to be placed in the first, the 13th column and in the R row. (Shadow area) (3) Keep at least one spacing row every four adjacent occupied rows to keep area for wiring. (4) Keep at least one spacing column in every other column, to assure indication of signal names.</p>	
8.	Cross reference	<p>(1) When signal line extends to another sheet of machine drawing, following informations are indicated automatically.</p> <p>K...15, B-10</p> <p>→ logic location to be connected → page number of logic diagram to be connected → terminal specification of signal destination</p> <p>K Sink S Source Z 3-state output N 3-state control</p>	

■ DESTINATION OF TEST PATTERNS

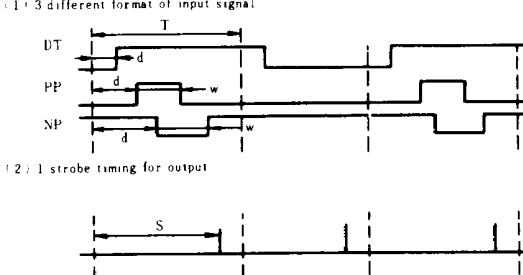
No.	Item	Rules	Examples																																																																																																	
1.	Timing format	<p>1: 3 different format of input signal</p>  <p>2: 1 strobe timing for output</p>	<table border="1"> <thead> <tr> <th colspan="2">Test Rate</th> <th colspan="3">300 ns</th> </tr> <tr> <th>Timing No.</th> <th>Format</th> <th>d(ns)</th> <th colspan="2">w(ns)</th> </tr> </thead> <tbody> <tr> <td>I₀</td> <td>DT</td> <td>—</td> <td colspan="2">—</td> </tr> <tr> <td>I₁</td> <td>DT</td> <td>20</td> <td colspan="2">—</td> </tr> <tr> <td>I₂</td> <td>PP</td> <td>50</td> <td colspan="2">150</td> </tr> <tr> <td>I₃</td> <td>NP</td> <td>70</td> <td colspan="2">100</td> </tr> <tr> <td>I₄</td> <td></td> <td></td> <td colspan="2"></td> </tr> <tr> <td>I₅</td> <td></td> <td></td> <td colspan="2"></td> </tr> <tr> <td>I₆</td> <td></td> <td></td> <td colspan="2"></td> </tr> <tr> <td>Output</td> <td>O₁</td> <td colspan="3">250 ns</td> </tr> </tbody> </table> <p>[Notes] 1. Number of input timing pulses: up to 7. 2. I₀ must be DT format with d = 0.</p>	Test Rate		300 ns			Timing No.	Format	d(ns)	w(ns)		I ₀	DT	—	—		I ₁	DT	20	—		I ₂	PP	50	150		I ₃	NP	70	100		I ₄					I ₅					I ₆					Output	O ₁	250 ns																																																	
Test Rate		300 ns																																																																																																		
Timing No.	Format	d(ns)	w(ns)																																																																																																	
I ₀	DT	—	—																																																																																																	
I ₁	DT	20	—																																																																																																	
I ₂	PP	50	150																																																																																																	
I ₃	NP	70	100																																																																																																	
I ₄																																																																																																				
I ₅																																																																																																				
I ₆																																																																																																				
Output	O ₁	250 ns																																																																																																		
2.	Test patterns	<p>(1) Specify signal order. iT = input (TTL Level) iC = input (CMOS Level) iTO = I/O (TTL Level) iCO = I/O (CMOS Level) OT = output OZ = 3-state output ODN = open drain output</p> <p>(2) Describe test pattern with following expression. Horizontal axis shows time.</p> <table border="1" data-bbox="535 1071 974 1197"> <thead> <tr> <th>Input</th> <th>Format</th> <th>Timing</th> </tr> </thead> <tbody> <tr> <td></td> <td>DT format</td> <td>0,1</td> </tr> <tr> <td></td> <td>PP format</td> <td>0,P</td> </tr> <tr> <td></td> <td>NP format</td> <td>1,N</td> </tr> <tr> <td>Output</td> <td></td> <td>H, L, Z, X, M</td> </tr> </tbody> </table> <p>(Note 1) P or N shows an active pulse in PP and NP format. (Note 2) Z high impedance X indefinite or masked M masked (Note 3) Black can be applied for no signal change.</p> <p>(3) When the same patterns are repeated, describe the following at the beginning of signal block.</p> <p>HORIZONTAL sc, ec; s₁, e₁, n₁/s₂, e₂, n₂/..</p> <div style="border: 1px solid black; padding: 5px; width: fit-content; margin: 10px auto;">Signal block</div> <p>sc~ec: valid column range for test patterns n_i: repeat number s_i: start column of repeat e_i: end column of repeat</p>	Input	Format	Timing		DT format	0,1		PP format	0,P		NP format	1,N	Output		H, L, Z, X, M	<table border="1" data-bbox="1039 808 1502 1039"> <thead> <tr> <th>Signal name</th> <th>I/O Format</th> <th>Pin No.</th> <th>Timing</th> </tr> </thead> <tbody> <tr> <td>INP-1</td> <td>iT</td> <td>15</td> <td>I₁</td> </tr> <tr> <td>INP-2</td> <td>iC</td> <td>7</td> <td>I₃</td> </tr> <tr> <td>⋮</td> <td></td> <td></td> <td></td> </tr> <tr> <td>BUS-1</td> <td>iTO</td> <td>41</td> <td>I₀</td> </tr> <tr> <td>⋮</td> <td></td> <td></td> <td></td> </tr> <tr> <td>OUT-1</td> <td>OT</td> <td>22</td> <td></td> </tr> <tr> <td>⋮</td> <td></td> <td></td> <td></td> </tr> </tbody> </table> <p>[Notes] 1. Signal name order may be free 2. BUS-1 input timing is I₀ and output strobe timing is O.</p> <div style="border: 1px solid black; padding: 5px; margin: 10px auto; width: fit-content;"> <p>HORIZONTAL 1, 30; 5, 10, 6/20, 25, 10</p> <table border="1" style="font-family: monospace; font-size: small;"> <tr> <td>0</td><td>1</td><td></td><td></td><td>0</td><td></td><td>1</td><td></td><td></td><td>0</td> </tr> <tr> <td>1</td><td></td><td>0</td><td></td><td></td><td>1</td><td></td><td>0</td><td></td><td>1</td> </tr> <tr> <td>0</td><td>X</td><td>H</td><td>L</td><td>Z</td><td>0</td><td></td><td>L</td><td></td><td>H</td> </tr> <tr> <td>X</td><td>H</td><td></td><td>L</td><td></td><td></td><td>H</td><td></td><td></td><td>L</td> </tr> <tr> <td>H</td><td></td><td>L</td><td></td><td></td><td>H</td><td></td><td></td><td></td><td>L</td> </tr> </table> </div> <p>[Note] "HORIZONTAL" line shows the start column and end column of described patterns together with the conditions for repeating.</p>	Signal name	I/O Format	Pin No.	Timing	INP-1	iT	15	I ₁	INP-2	iC	7	I ₃	⋮				BUS-1	iTO	41	I ₀	⋮				OUT-1	OT	22		⋮				0	1			0		1			0	1		0			1		0		1	0	X	H	L	Z	0		L		H	X	H		L			H			L	H		L			H				L
Input	Format	Timing																																																																																																		
	DT format	0,1																																																																																																		
	PP format	0,P																																																																																																		
	NP format	1,N																																																																																																		
Output		H, L, Z, X, M																																																																																																		
Signal name	I/O Format	Pin No.	Timing																																																																																																	
INP-1	iT	15	I ₁																																																																																																	
INP-2	iC	7	I ₃																																																																																																	
⋮																																																																																																				
BUS-1	iTO	41	I ₀																																																																																																	
⋮																																																																																																				
OUT-1	OT	22																																																																																																		
⋮																																																																																																				
0	1			0		1			0																																																																																											
1		0			1		0		1																																																																																											
0	X	H	L	Z	0		L		H																																																																																											
X	H		L			H			L																																																																																											
H		L			H				L																																																																																											

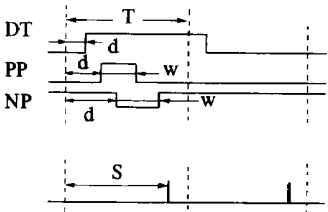
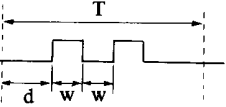
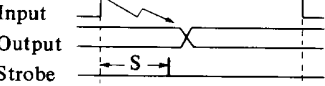
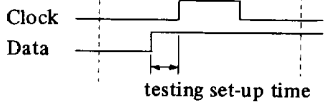
No.	Item	Rules	Examples																				
3	Fault coverage and auto-generation of test patterns	<p>(1) Auto generated test patterns detects the faults which test patterns of user's design have not detected. Two test patterns, of user's design and auto-generation, are available for final testing of products.</p> <p>(2) Auto-generated test patterns is to increase the fault coverage. It disregards the real time function of user's hardware. Therefore, user has to design test patterns taking real time function into consideration.</p> <p>When auto-diagnosis is not required, the final test of products is performed only with test patterns designed for logic verification.</p> <p>Fault coverage of test patterns shall be as high as possible (final target $\geq 95\%$). Undetected faults by the test patterns is strongly suggested to be checked in the system test at the user's assembly line.</p>																					
4	Contents of test patterns	<p>It is requested to submit following two test patterns, functional test patterns and high speed test patterns which are generated under the timing restriction shown below respectively. In low speed application, it is allowed to omit high speed test patterns.</p> <p>(1) Functional test $T \geq 60, d \geq 5, w \geq 12.5$ $T - (d + w) \geq 5, 0 \leq S < T$</p> <p>(2) High speed test (a) Cycle test To test real dynamic function. (b) Delay test To measure delay time along specified critical path of input to output. (c) Skew test To test set up time and hold time.</p> <table border="1" data-bbox="391 1402 954 1556"> <thead> <tr> <th></th> <th>Cycle test</th> <th>Delay test</th> <th>Skew test</th> </tr> </thead> <tbody> <tr> <td>T</td> <td>500</td> <td>500</td> <td>500</td> </tr> <tr> <td>d</td> <td>≥ 5</td> <td>0</td> <td>≥ 5</td> </tr> <tr> <td>w</td> <td>≥ 12.5</td> <td>-</td> <td>≥ 12.5</td> </tr> <tr> <td>s</td> <td>450</td> <td>≥ 0</td> <td>450</td> </tr> </tbody> </table>		Cycle test	Delay test	Skew test	T	500	500	500	d	≥ 5	0	≥ 5	w	≥ 12.5	-	≥ 12.5	s	450	≥ 0	450	<p>(1) Functional test</p>  <p>(2) High speed test (a) Cycle test Corresponding 40 MHz When assuming $w = 12.5$</p>  <p>(b) Delay test</p>  <p>(c) Skew test</p>  <p style="text-align: right;">testing set-up time</p>
	Cycle test	Delay test	Skew test																				
T	500	500	500																				
d	≥ 5	0	≥ 5																				
w	≥ 12.5	-	≥ 12.5																				
s	450	≥ 0	450																				
5	Limitation of test patterns	<p>(1) Up to 10 sets of test patterns. (2) Up to 30000 test cycles after expanding the repeat in a set of test patterns. (3) Total steps for all sets of test patterns. (Repeat is counted as 1 time) is limited as shown in table on right.</p>	<table border="1" data-bbox="976 1612 1471 1864"> <thead> <tr> <th></th> <th>Functional test</th> <th>High speed test</th> </tr> </thead> <tbody> <tr> <td>E08~E43</td> <td>4000</td> <td rowspan="3">4000</td> </tr> <tr> <td>E58</td> <td>6000</td> </tr> <tr> <td>E75</td> <td>8000</td> </tr> <tr> <td>E101</td> <td>11000</td> <td rowspan="4">8000</td> </tr> <tr> <td>E130</td> <td>15000</td> </tr> <tr> <td>E182</td> <td>22000</td> </tr> <tr> <td>E240</td> <td>30000</td> </tr> </tbody> </table>		Functional test	High speed test	E08~E43	4000	4000	E58	6000	E75	8000	E101	11000	8000	E130	15000	E182	22000	E240	30000	
	Functional test	High speed test																					
E08~E43	4000	4000																					
E58	6000																						
E75	8000																						
E101	11000	8000																					
E130	15000																						
E182	22000																						
E240	30000																						

■ NOTES FOR LOGIC DESIGN

No.	Item	Notes																								
1.	Utilization	<p>Must be 90% or less in order to place and route successfully. When auto-diagnosis is used, must be 85% or less.</p> <p>Auto-diagnosis causes overhead. You have to take overhead into consideration when auto-diagnosis is required.</p> <p>The estimation of overhead depends on the numbers of latches, flip-flops and shift resistors (N_F). The right equation shows the calculation.</p>																								
		<p>Maximum gate counts to be used actually.</p> <table border="1"> <tr> <td>E08</td> <td>E11</td> <td>E15</td> <td>E22</td> <td>E33</td> </tr> <tr> <td>700 (660)</td> <td>1050 (990)</td> <td>1360 (1290)</td> <td>1960 (1850)</td> <td>2970 (2800)</td> </tr> </table> <table border="1"> <tr> <td>E43</td> <td>E58</td> <td>E75</td> <td>E101</td> <td>E130</td> <td>E182</td> <td>E240</td> </tr> <tr> <td>3880 (3660)</td> <td>5240 (4950)</td> <td>6740 (6360)</td> <td>9070 (8560)</td> <td>11710 (11060)</td> <td>16360 (15450)</td> <td>21620 (20420)</td> </tr> </table> <p>() : When auto-diagnosis is used. [Maximum gate counts] \geq (gate counts in user's logic) + 1.7 \times N_F</p>	E08	E11	E15	E22	E33	700 (660)	1050 (990)	1360 (1290)	1960 (1850)	2970 (2800)	E43	E58	E75	E101	E130	E182	E240	3880 (3660)	5240 (4950)	6740 (6360)	9070 (8560)	11710 (11060)	16360 (15450)	21620 (20420)
E08	E11	E15	E22	E33																						
700 (660)	1050 (990)	1360 (1290)	1960 (1850)	2970 (2800)																						
E43	E58	E75	E101	E130	E182	E240																				
3880 (3660)	5240 (4950)	6740 (6360)	9070 (8560)	11710 (11060)	16360 (15450)	21620 (20420)																				
2.	Auto-diagnosis	<p>(1) Need two test dedicated pins. (2) Use latch, flip-flop and shift resistor with scan function.</p>																								
3.	Gate delay	<p>Gate delay is obtained more accurately after place and route. However rough estimate should also be done using the equations shown right to prevent timing design errors in the earlier design phase.</p> <p>Effective Fan Out is calculated as sum of Normalized Loading Factor of the output node. These equation may contain the design margin a little bit.</p>																								
		<div style="border: 1px solid black; padding: 5px; width: fit-content;"> $t_{PLH} = t_{OLH} + K_{LH} \cdot C_L$ $t_{PHL} = t_{OHL} + K_{HL} \cdot C_L$ </div> <p>Where, for internal gates $C_L = 0.4 \times EFO$ $EFO = \sum NLF$ Variational range: Min = 0.35 \times typ Max = 1.8 \times typ ($T_a = -20$ to $+75^\circ C$, $V_{CC} = 5V \pm 5\%$)</p>																								
4.	Maximum fanout	<p>A clock driver, which drives CK inputs of FF's, has a restriction on the number of applicable fanouts, though the other signals have no limitation if lower speed is acceptable.</p>																								
		<p>○ Max. Fanout of CK driver Power Inverter . . . 20/30/40 The others 10 ○ The other signals 24</p>																								
5.	Automatic Modification of unconnected inputs of macro	<p>When an input of a macro is left unconnected, the automatic router connects it to either VCC ("1" level) or GND ("0" level). The macrocell list shows which input of each macro will be connected to which level.</p> <p>An input of AND or NAND gates will be connected to VCC, and that of OR or NOR gates to GND, even though these are not indicated in the list. "@" beside an input shows that the input will be connected to VCC, and "#" to GND. It is not allowed to leave an input unconnected dropping "@" nor "#" except the cases of AND, NAND, OR or NOR.</p>																								
		<p>When inputs are left open, input A will be fixed to "0" input Y will be fixed to "1".</p>																								
6.	Simultaneous Turn on/off of Output Buffers	<p>The number of output buffers which simultaneously change their output levels must be equal to or less than the figures in the table respectively depending on the buffers.</p>																								
		<table border="1"> <thead> <tr> <th>Buffer</th> <th>max. number</th> </tr> </thead> <tbody> <tr> <td>OT, $\bar{O}Z$, $\bar{O}DN$</td> <td>8</td> </tr> <tr> <td>OTR, OZR, ODNR</td> <td>12</td> </tr> </tbody> </table>	Buffer	max. number	OT, $\bar{O}Z$, $\bar{O}DN$	8	OTR, OZR, ODNR	12																		
Buffer	max. number																									
OT, $\bar{O}Z$, $\bar{O}DN$	8																									
OTR, OZR, ODNR	12																									
7.	Testing	<p>(1) All the logic must be able to be initialized by external inputs. (2) Restriction due to the Simulator. (a) When one or more inputs associated with FF such as CK, CL and PR is indefinite the output is also indefinite. For example, output of FF will not be fixed when CK input is indefinite even if it is quite evident logically that CK input is stable either in high or low level.</p>																								

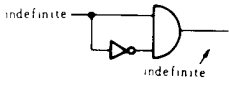
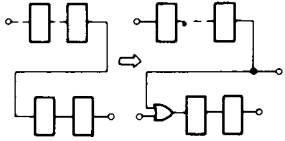
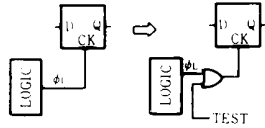
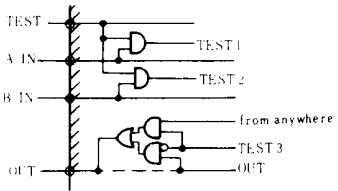
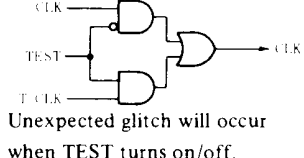
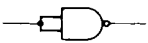
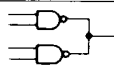
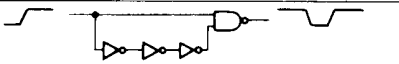
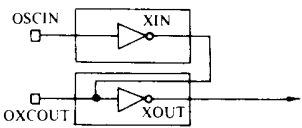
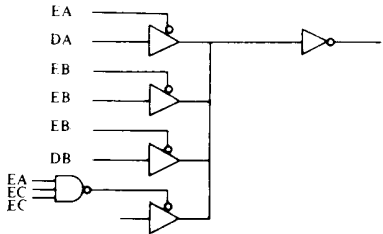
No.	Item	Notes
		<p>(b) For the given logical variables X, Y, suppose that there is the following relation between them $X = \bar{Y}$ When X or Y is indefinite, both X + Y and X · Y are also indefinite contrary to the theoretical result.</p>  <p>(3) It is preferable to split a multistage shift registers and/or counters to provide test signals in the proper positions in order to improve the efficiency of testing.</p>  <p>(4) It is preferable to provide test clock in addition to the original clock whose frequency is much lower than other clocks such as a system clock.</p>  <p>(5) The figure shows an example of additional test logic to generate several test signals from a single TEST pin, which is helpful when we suffer from the shortage of pins. Another example shown here is to share the output pin to monitor another internal signal.</p>  <p>(6) It is very important to do timing design of test logic as well. Is test logic speed OK? Won't unexpected events occur at the transition time from test to normal mode or contrary?</p>  <p>Unexpected glitch will occur when TEST turns on/off.</p>
8.	Others	<p>(1) As far as a macro is concerned, one signal is prohibited to be employed to multi-input terminals.</p>  <p>(2) Output-to-output connection is not allowed except among 3-state buffers.</p>  <p>(3) A chopper circuit using gate delay is prohibited.</p>  <p>(4) Oscillator circuit should be built as shown. OSC IN and OSC OUT pins should be assigned next to the pins which never change their levels, such as V_{CC} and GND.</p>  <p>(5) Internal bus lines should be prevented from floating. Dummy 3-state buffer is recommended to be added.</p> 

■ LOGIC DIAGRAM

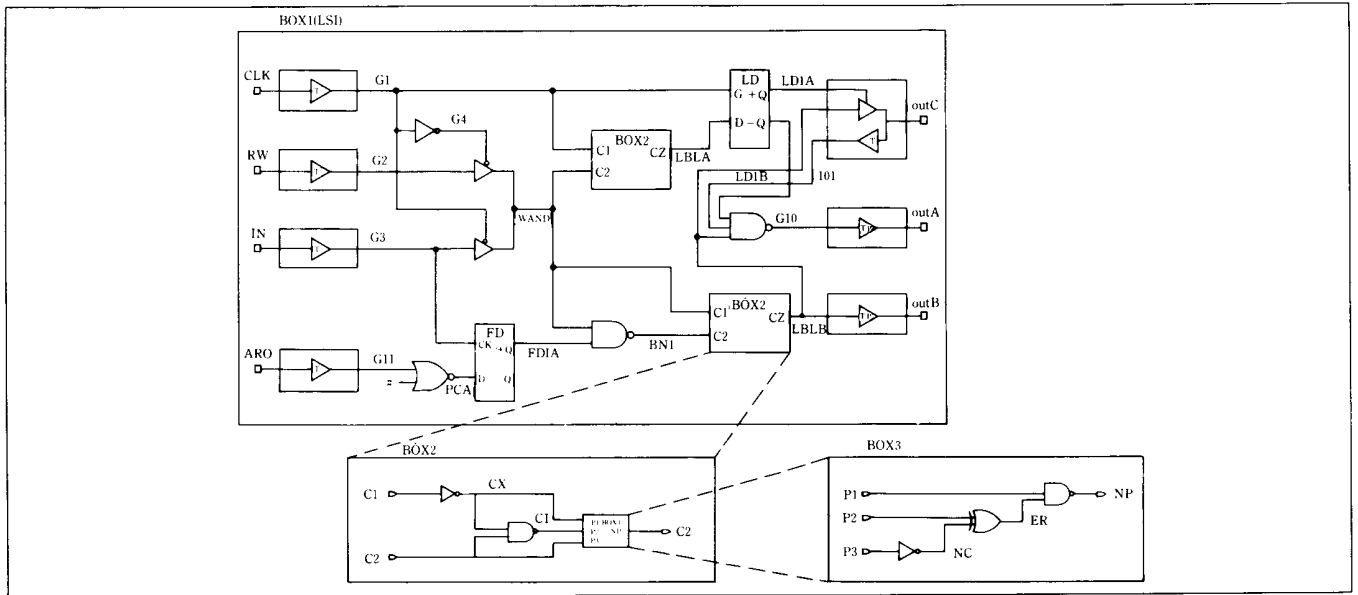

■ EXAMPLE OF LOGIC DESCRIPTION

<p>LSI profile</p>	<pre> BEGIN PROFILE BEGIN PRODUCT BOX1 IMPLEMENT GATEARRAY SERIES (HG62E43) ARRAY (HG62E) ROOTBLOCK BOX1 ARRANGE DP40B0 PACKAGE DP40 END PROFILE </pre>	<p>Device Type, master type, package type</p>
<p>Schematic description</p>	<pre> BEGIN LOGIC BEGIN BLOCK BOX1 INTERFACE RW, IN, CLK, ARO; OUTB, OUTA; OUTC BEGIN NETLIST G11 (L3, ,1) IT ARO; G11 G1 (B3, ,1) IT CLK; G1 G2 (D3, ,1) IT RW; G2 G3 (F3, ,1) IT IN; G3 AR (L4, ,1) NR2 G11; PCA G4 (C4, ,1) NA1 G1; G4 FD1 (J5, ,1) FD G3; PCA; FD1A G5 (D5, ,1) ANZ G4, G2; WAND G6 (F5, ,1) ANZ G1, G3; WAND BN1 (J6, ,1) NA2 WAND, FD1A,; BN1 LBL2 (G7, ,1) BOX2 BN1, WAND; LBLB LBL1 (C7, ,1) BOX2 WAND, G1; LBLA LD1 (B8, ,1) LD G1, LBLA; LD1A, LD1B G8 (E11, ,1) OT C10; OUTA G7 (G9, ,1) OT LBLB; OUTB G10 (E9, ,1) NA3 IO1, LD1B, LBLB; G10 G9 (C11, ,1) ITO LD1A, LBLB; IO1; OUTC END NETLIST END BLOCK </pre>	<p>Pin assignment</p> <p>The diagram shows the macro function name G4 (C4, ,1) NA1 G1; G4. Arrows point to different parts of this name: 'G4' is the Element name, '(C4, ,1)' is the Location of symbol, 'NA1' is the Macro function name, 'G1' is the Input signal name, and 'G4' is the Output signal name.</p>

	<pre> BEGIN BLOCK BOX2 INTERFACE C2, C1: CZ SHAPE; J4, 2, A3 BEGIN NETLIST CX (D3, ,2) NA1 C1; CX CY (F5, ,2) NA2 CX, C2; CY PBK1 (F7, ,2) BOX3 C2, CY, CX; CZ END NETLIST END BLOCK </pre>	<p>Description of BOX2 (User defined macro)</p>
	<pre> BEGIN BLOCK BOX3 INTERFACE P3, P2, P1; NP SHAPE; J6, 1, A3 BEGIN NETLIST NG (E3, ,3) NA1 P3; NG ER (D4, ,3) EOR P2, NG; ER NP (B5, ,3) NAP2 P1, ER; NP END NETLIST END BLOCK END LOGIC </pre>	<p>Description of BOX3 (User defined macro)</p>
<p>Test patterns</p>	<pre> BEGIN TEST BEGIN PATTERN CASE1 BLOCKNAME BOX1 TIMING TRATE (150. 0N) STRB (120. 0N) BEGIN SIGNAL ARO DT (20. 0N) CLK DT (0. 0N) IN PP (50. 0N, 100. 0N) OUTA OUTB OUTC DT (0. 0N) RW NP (50. 0N, 100. 0N) END SIGNAL </pre>	<p>Definition of timing</p>
	<pre> BEGIN VECTOR HORIZONTAL 1, 1010101 ARO 1100101 CLK POPOPOP IN LLLLLLL OUTA LLLLLLL OUTB 111H1H1 OUTC N1N1111 RW END VECTOR END PATTERN END TEST </pre>	<p>Description of test patterns</p> <p>In this case, the horizontal axis shows time, but there is another way of description that the vertical axis shows time.</p>
<p>Verification</p>	<pre> BEGIN VERIFY BEGIN LOGSIM CASE1 TESTNAME CASE1 DELAY TYPICAL LOADC FANOUT DEFAULT STRB (120. 0N) BEGIN MONITOR MON1 BOX1. LBL1. CX STRB (140. 0N) BOX1. LBL2. CX STRB (140. 0N) END MONITOR COMPARE SRL SIGNAL (EXTERNAL' MONITOR (MON1)) SRF SIGNAL (EXTERNAL, MONITOR (MON1)) ERROR CONFLICT' TIME (10, 0N, 10. 0N) FAULT SEPARATE (1,999), ASSUME (1), DETECT (2), MODIFY STOP 7 END LOGSIM </pre>	<p>Condition of logic simulation</p>
	<pre> BEGIN TIMING TIM1 TESTNAME CASE1 DELAY TYPICAL LOADC ROUTING END TIMING END VERIFY </pre>	<p>Specification of timing verification</p>

■ MACRO CELL LIBRARY

1. Input/Output Buffers

Macrocell		Equiva- lent Gate Count	Normalized Load Factor	Clamp Level when Open	Symbol	Symbol No.	Delay			
Function	Equivalent Circuit						t _{PLH} (ns)		t _{PHL} (ns)	
Macro Function Name							t _{OLH}	k _{LH}	t _{OHL}	k _{HL}
Input Buffer TTL Level		—	—			D1	1.5	0.4	2.0	0.9
IT										
Input Buffer CMOS Level		—	—			D1	2.0	0.4	2.0	0.8
IC										
SCHMITT TTL Level		—	—			D1	2.5	1.3	9.2	2.0
ITS										
SCHMITT CMOS Level		—	—			D1	2.0	0.6	3.6	1.1
ICS										
OUTPUT		—	1.2			D1	2.0	0.12	2.3	0.1
OT										
3-State OUTPUT		—	1.2 1.4			(D)	2.2		2.3	
OZ						D1		0.12		0.1
						(E)	2.6		2.5	
Open Drain Output		—	1.2			D1	—	—	2.3	0.1
ODN										

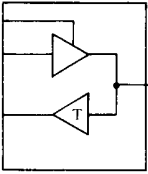
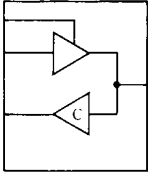
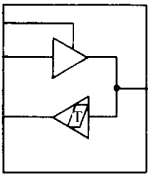
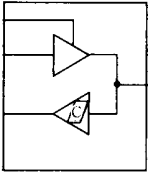
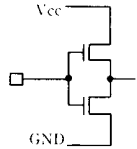
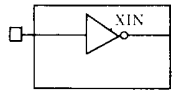
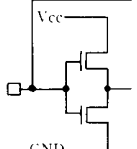
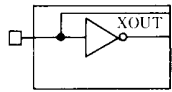
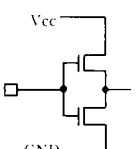
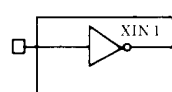
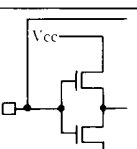
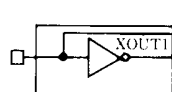
Macrocell		Equiva- lent Gate Count	Normalized Load Factor	Clamp Level when Open	Symbol	Symbol No.	Delay			
Function	Equivalent Circuit						t _{PLH} (ns)		t _{PHL} (ns)	
Macro Function Name							t _{OLH}	k _{LH}	t _{OHL}	k _{LH}
I/O Buffer TTL Level	Output See "3-state"	-	1.2 1.4			D2	Output See "3-state"			
ITO	Input See "Input Buffer"						Input See "Input Buffer"			
I/O Buffer CMOS Level	Output See "3-state"	-	1.2 1.4			D2	Output See "3-state"			
ICO	Input See "Input Buffer"						Input See "Input Buffer"			
I/O Buffer TTL SCHMITT Level	Output See "3-state"	-	1.2 1.4			D2	Output See "3-state"			
ITSO	Input See "Input Buffer"						Input See "Input Buffer"			
I/O Buffer CMOS SCHMITT Level	Output See "3-state"	-	1.2 1.4			D2	Output See "3-state"			
ICSO	Input See "Input Buffer"						Input See "Input Buffer"			
OSC In 2MHz to 20MHz		-	-			D1	3.1	0.8	3.2	0.8
XIN										
OSC Out 2MHz to 20MHz		-	-			D1	4.0	1.2	2.5	0.9
XOUT										
OSC In 32kHz to 400kHz		-	-			D1	3.1	40	3.2	40
XIN1										
OSC Out 32kHz to 400kHz		-	-			D1	4.0	1.2	2.5	0.9
XOUT1										

Macrocell		Equiva- lent Gate Count	Normalized Load Factor	Clamp Level when Open	Symbol	Symbol No.	Delay			
Function	Equivalent Circuit						tPLH (ns)		tPHL (ns)	
Macro Function Name							tOLH	kLH	tOHL	kHL
Input Buffer TTL Level with Pull-Up ITU		—	—			D2	1.5	0.4	2.0	0.9
Input Buffer TTL Level with Pull- Down ITD		—	—			D2	1.5	0.4	2.0	0.9
Input Buffer CMOS Level with Pull-Up ICU		—	—			D2	2.0	0.4	2.0	0.8
Input Buffer CMOS Level with Pull- Down ICD		—	—			D2	2.0	0.4	2.0	0.8
Schmitt TTL Level with Pull-Up ITSU		—	—			D2	2.5	1.3	9.2	2.0
Schmitt TTL Level with Pull- Down ITSD		—	—			D2	2.5	1.3	9.2	2.0
Schmitt CMOS Level with Pull-Up ICSU		—	—			D2	2.0	0.6	3.6	1.1
Schmitt CMOS Level with Pull- Down ICSD		—	—			D2	2.0	0.6	3.6	1.1

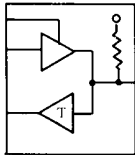
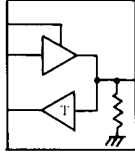
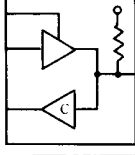
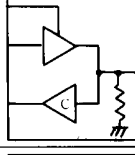
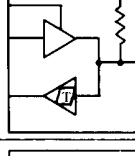
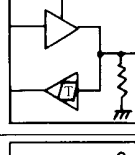
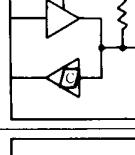
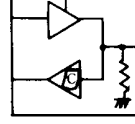
Macrocell		Equivalent Gate Count	Normalized Load Factor	Clamp Level when Open	Symbol	Symbol No.	Delay			
Function	Equivalent Circuit						t _{PLH} (ns)		t _{PHL} (ns)	
Macro Function Name							t _{OLH}	k _{LH}	t _{OHL}	k _{HL}
I/O Buffer TTL Level with Pull-Up ITOU	Output See "3-state"	-	1.2 1.4			D2	Output See "3-state"			
	Input See "Input Buffer"						Input See "Input Buffer"			
I/O Buffer TTL Level with Pull-Down ITOD	Output See "3-state"	-	1.2 1.4			D2	Output See "3-state"			
	Input See "Input Buffer"						Input See "Input Buffer"			
I/O Buffer CMOS Level with Pull-Up ICOU	Output See "3-state"	-	1.2 1.4			D2	Output See "3-state"			
	Input See "Input Buffer"						Input See "Input Buffer"			
I/O Buffer CMOS Level with Pull-Down ICOD	Output See "3-state"	-	1.2 1.4			D2	Output See "3-state"			
	Input See "Input Buffer"						Input See "Input Buffer"			
I/O Buffer TTL Schmitt Level with Pull-Up ITSOU	Output See "3-state"	-	1.2 1.4			D2	Output See "3-state"			
	Input See "Input Buffer"						Input See "Input Buffer"			
I/O Buffer TTL Schmitt Level with Pull-Down ITSOD	Output See "3-state"	-	1.2 1.4			D2	Output See "3-state"			
	Input See "Input Buffer"						Input See "Input Buffer"			
I/O Buffer CMOS Schmitt Level with Pull-Up ICSOU	Output See "3-state"	-	1.2 1.4			D2	Output See "3-state"			
	Input See "Input Buffer"						Input See "Input Buffer"			
I/O Buffer CMOS Schmitt Level with Pull-Down ICSOD	Output See "3-state"	-	1.2 1.4			D2	Output See "3-state"			
	Input See "Input Buffer"						Input See "Input Buffer"			











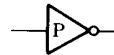

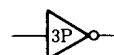

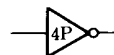
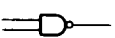
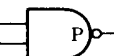

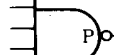

Macrocell		Equivalent Gate Count	Normalized Load Factor	Clamp Level when Open	Symbol	Symbol No.	Delay			
Function	Equivalent Circuit						t _{PLH} (ns)		t _{PHL} (ns)	
Macro Function Name							t _{OLH}	k _{LH}	t _{OHL}	k _{HL}
3-State Output with Pull-Up OZU		—	1.2 1.4			(D) D2 (D)	2.2 — 2.6	0.12	2.3 — 2.5	0.1
3-State Output with Pull-Down OZD		—	1.2 1.4			(D) D2 (E)	2.2 — 2.6	0.12	2.3 — 2.5	0.1
Open Drain Output with Pull-Up ODNU		—	1.2			D2	—	—	2.3	0.1

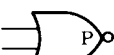
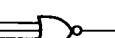
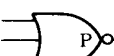
GND Noise Reduction Buffers

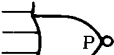

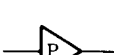





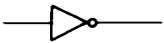

Macrocell		Equivalent Gate Count	Normalized Load Factor	Clamp Level when Open	Symbol	Symbol No.	Delay			
Function	Equivalent Circuit						t _{PLH} (ns)		t _{PHL} (ns)	
Macro Function Name							t _{OLH}	k _{LH}	t _{OHL}	k _{HL}
Totem-pole output OTR		—	1.2			D1	3.7	0.12	12.6	0.12
3-state output OZR		—	1.2 1.4			(D) D1 (E)	3.2 — 3.6	0.12	6.2 — 6.4	0.1
Open-drain output ODNR		—	1.2			D1	—	—	6.2	0.1
I/O buffer TTL level ITOR	Output See "3-state" Input See "Input buffers"	—	1.2 1.4			D2	Output See "3-state" (OZR) Input See "Input buffers"			
I/O buffer CMOS level ICOR	Output See "3-state" Input See "Input buffers"	—	1.2 1.4			D2	Output See "3-state" (OZR) Input See "Input buffers"			
I/O buffer TTL Schmitt-trigger ITSOR	Output See "3-state" Input See "Input buffers"	—	1.2 1.4			D2	Output See "3-state" (OZR) Input See "Input buffers"			
I/O buffer CMOS Schmitt-trigger ICSOR	Output See "3-state" Input See "Input buffers"	—	1.2 1.4			D2	Output See "3-state" (OZR) Input See "Input buffers"			

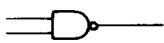
Macrocell		Equivalent Gate Count	Normalized Load Factor	Clamp Level when Open	Symbol	Symbol No.	Delay			
Function	Equivalent Circuit						t _{PLH} (ns)		t _{PHL} (ns)	
							t _{OLH}	k _{LH}	t _{OHL}	k _{HL}
3-state output with Pull-Up OZRU		-	1.2 1.4			(D) D2 (E)	3.2	0.12	6.2	0.1
							3.6		6.4	
							3-state output with Pull-Down OZRD		-	1.2 1.4
3.6	6.4									
Open-drain output with Pull-Up ODNRU		-	1.2			D2	-	-	6.2	0.1
I/O buffer TTL level with Pull-Up ITORU	Output See "3-state"	-	1.2 1.4			D2	Output See "3-state" (OZR)			
	Input See "Input buffers"						Input See "Input buffers"			
I/O buffer TTL level with Pull-Down ITORD	Output See "3-state"	-	1.2 1.4			D2	Output See "3-state" (OZR)			
	Input See "Input buffers"						Input See "Input buffers"			
I/O buffer CMOS level with Pull-Up ICORU	Output See "3-state"	-	1.2 1.4			D2	Output See "3-state" (OZR)			
	Input See "Input buffers"						Input See "Input buffers"			
I/O buffer CMOS level with Pull-Down ICORD	Output See "3-state"	-	1.2 1.4			D2	Output See "3-state" (OZR)			
	Input See "Input buffers"						Input See "Input buffers"			
I/O buffer TTL Schmitt-trigger with Pull-Up ITSORU	Output See "3-state"	-	1.2 1.4			D2	Output See "3-state" (OZR)			
	Input See "Input buffers"						Input See "Input buffers"			
I/O buffer TTL Schmitt-trigger with Pull-Down ITSORD	Output See "3-state"	-	1.2 1.4			D2	Output See "3-state" (OZR)			
	Input See "Input buffers"						Input See "Input buffers"			
I/O buffer CMOS Schmitt-trigger with Pull-Up ICSORU	Output See "3-state"	-	1.2 1.4			D2	Output See "3-state" (OZR)			
	Input See "Input buffers"						Input See "Input buffers"			
I/O buffer CMOS Schmitt-trigger with Pull-Down ICSORD	Output See "3-state"	-	1.2 1.4			D2	Output See "3-state" (OZR)			
	Input See "Input buffers"						Input See "Input buffers"			





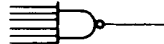

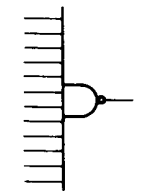
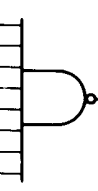
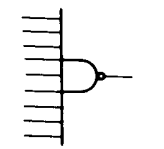
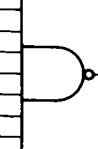
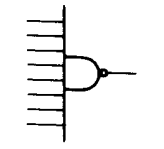
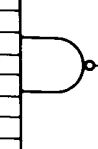

2. Power Gates

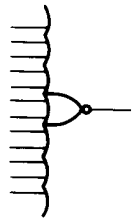
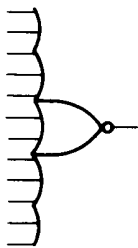
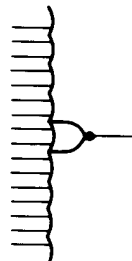
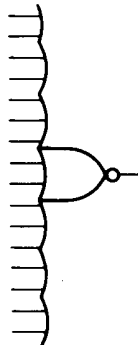
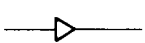



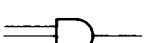

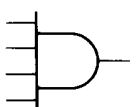

Macrocell		Equivalent Gate Count	Normalized Load Factor	Clamp Level when Open	Symbol	Symbol No.	Delay			
Function	Equivalent Circuit						t _{PLH} (ns)		t _{PHL} (ns)	
Macro Function Name							t _{OLH}	k _{LH}	t _{OHL}	k _{HL}
Power inverter		1	1.2	@		-	0.3	0.6	0.3	0.5
NAP1										
Power inverter		2	1.4	@		-	0.3	0.4	0.6	0.4
NA3P										
Power inverter		2	1.6	@		-	0.3	0.3	0.6	0.3
NA4P										
2-input power NAND		2	1.2	@		-	0.3	0.6	0.4	0.6
NAP2										
3-input power NAND		3	1.2	@		-	0.3	0.6	0.4	0.7
NAP3										
4-input power NOR		4	1.2	@		-	0.3	0.6	0.4	0.8
NAP4										
2-input power NOR		2	1.2	#		-	0.4	1.0	0.6	0.5
NRP2										
3-input power NOR		3	1.2	#		-	0.4	1.4	0.6	0.5
NRP3										
4-input power NOR		4	1.2	#		-	0.5	1.9	0.6	0.5
NRP4										
Power buffer		2	1.0	@		-	0.8	0.6	0.6	0.5
ANP										
Power buffer		3	1.2	@		-	0.7	0.4	0.5	0.4
AN3P										
Power buffer		3	1.2	@		-	0.8	0.3	0.6	0.3
AN4P										

3. GATES

Macrocell		Equivalent Gate Count	Normalized Load Factor	Clamp Level when Open	Symbol	Symbol No.	Delay			
Function	Equivalent Circuit						t _{PLH} (ns)		t _{PHL} (ns)	
Macro Function Name							t _{OLH}	k _{LH}	t _{OHL}	k _{HL}
Inverter NA1		1	1	@		-	0.2	1.2	0.3	0.9
2-Input NAND NA2		1	1	@		-	0.2	1.2	0.3	1.2
3-Input NAND NA3		2	1	@		-	0.2	1.2	0.3	1.3
4-Input NAND NA4		2	1	@		-	0.3	1.2	0.3	1.5
6-Input NAND NA6		5	1	@		-	0.8	1.2	1.5	0.9
8-Input NAND NA8		6	1	@		-	0.9	1.2	1.6	0.9
9-Input NAND NA9		7	1	@		-	0.9	1.2	1.6	0.9
12-Input NAND NA12		8	1	@		-	0.9	1.2	1.9	0.9

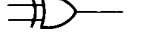
Macrocell		Equivalent Gate Count	Normalized Load Factor	Clamp Level when Open	Symbol	Symbol No.	Delay			
Function	Equivalent Circuit						t _{PLH} (ns)		t _{PHL} (ns)	
Macro Function Name							t _{OLH}	k _{LH}	t _{OHL}	k _{HL}
16-Input NAND		11	1	@		-	0.9	1.2	1.6	1.2
NA16										
2-Input NOR		1	1	#		-	0.3	2.0	0.7	0.9
NR2										
3-Input NOR		2	1	#		-	0.4	2.8	0.7	0.9
NR3										
4-Input NOR		2	1	#		-	0.4	3.7	0.7	0.9
NR4										
6-Input NOR		5	1	#		-	1.2	1.2	1.0	0.9
NR6										
8-Input NOR		6	1	#		-	1.3	1.2	1.0	0.9
NR8										
9-Input NOR		7	1	#		-	1.3	1.2	1.0	0.9
NR9										

Macrocell		Equivalent Gate Count	Normalized Load Factor	Clamp Level when Open	Symbol	Symbol No.	Delay			
Function	Equivalent Circuit						t _{PLH} (ns)		t _{PHL} (ns)	
Macro Function Name							t _{OLH}	k _{LH}	t _{OHL}	k _{HL}
12-Input NOR		8	1	#		-	1.4	1.2	1.0	0.9
NR12										
16-Input NOR		11	1	#		-	1.3	2.0	1.0	0.9
NR16										
Buffer		1	1	@		-	0.6	1.2	0.5	0.9
AN1										
2-input AND		2	1	@		-	0.7	1.2	0.5	0.9
AN2										
3-input AND		2	1	@		-	0.9	1.2	0.7	0.9
AN3										
4-input AND		3	1	@		-	1.0	1.2	0.8	0.9
AN4										
2-input OR		2	1	#		-	0.7	1.2	0.7	0.9
OR2										

Macrocell		Equivalent Gate Count	Normalized Load Factor	Clamp Level when Open	Symbol	Symbol No.	Delay			
Function	Equivalent Circuit						t _{PLH} (ns)		t _{PHL} (ns)	
Macro Function Name							t _{OLH}	k _{LH}	t _{OHL}	k _{HL}
3-input OR		2	1	#		-	0.7	1.2	0.9	0.9
OR3										
4-input OR		3	1	#		-	0.7	1.2	1.2	0.9
OR4										
2-input EOR		3	1.2	#		-	1.0	2.0	1.1	0.9
EOR										
2-input ENOR		3	1.2	#		-	0.9	1.2	1.0	1.2
ENR										

4. 3-STATE GATES

Macrocell		Equivalent Gate Count	Normalized Load Factor	Clamp Level When Open	Symbol	Symbol No.	Delay					
Function	Equivalent Circuit						Input Name	Output Name	$t_{PLH}(ns)$		$t_{PHL}(ns)$	
Function Name									t_{OLH}	K_{LH}	t_{OHL}	K_{HL}
3-State Inverter (Internal) NAZ		1	1	@		-	D	0.4	2.0	0.8	1.2	
							E/ \bar{E}	0.2		0.3		
3-State Buffer (Internal) ANZ		3	1.2	# @		-	D	0.8	1.2	0.7	0.9	
							E	1.0		1.0		

5. AND-NOR, OR-AND GATES

Macrocell		Equivalent Gate Count	Normalized Load Factor	Clamp Level When Open	Symbol	Symbol No.	Delay					
Function	Equivalent circuit						Input Name	Output Name	$t_{PLH}(ns)$		$t_{PHL}(ns)$	
Function Name									t_{OLH}	K_{LH}	t_{OHL}	K_{HL}
2-OR-NAND NAR23		2	1	# # @		A1	OR input	0.4	2.0	0.8	1.2	
							NAND input	0.3		0.8		
3-OR-NAND NAR34		2	1	# # # @		A2	OR input	0.5	2.8	0.8	1.2	
							NAND input	0.4		0.8		
2-OR-3NAND NAR24		2	1	# # @ @		A2	OR input	0.4	2.0	0.9	1.3	
							NAND input	0.4		0.8		
2-Wide 2-Input OR-NAND NA2R2		2	1	# # #		A1		0.4	2.0	0.8	1.2	

Macrocell		Equivalent Gate Count	Normalized Load Factor	Clamp Level When Open	Symbol	Symbol No.	Input Name	Output Name	Delay				
Function	Equivalent Circuit								$t_{PLH}(ns)$		$t_{PHL}(ns)$		
Function Name									t_{OLH}	K_{LH}	t_{OHL}	K_{HL}	
3-Wide 3-Input OR-NAND		3	1	# # # # #		A3			0.4	2.0	0.9	1.3	
NA3R2													
2-Wide 3-Input OR-NAND		4	1	# # # # #		A2	NAND		0.8	2.8	1.0	1.2	
NA2R3N							In- verter		1.2	1.2	1.1	0.9	
2-Wide 4-Input OR-NAND		5	1	# # # # # #		A4	NAND		1.1	3.7	1.0	1.2	
NA2R4N							In- verter		1.2	1.2	1.4	0.9	
3-Wide 3-Input OR-NAND		5	1	# # # # # #			NAND		1.0	2.8	1.2	1.3	
NA3R3N							In- verter		1.4	1.2	1.3	0.9	
3-Wide 4-Input OR-NAND		7	1	# # # # # # #			NAND		1.4	3.7	1.2	1.3	
NA3R4N							In- verter		1.4	1.2	1.7	0.9	

Macrocell		Equivalent Gate Count	Normalized Load Factor	Clamp Level When Open	Symbol	Symbol No.	Delay					
Function	Equivalent Circuit						Input Name	Output Name	$t_{PLH}(ns)$		$t_{PHL}(ns)$	
Function Name									t_{OLH}	K_{LH}	t_{OHL}	K_{HL}
4-Wide 2-Input OR-NAND		5	1	@@@ @@@ @@@ @@@ @@@ @@@	A4		NAND	0.7	2.0	1.3	1.5	
NA4R2N								In-verter	1.5	1.2	1.0	0.9
4-Wide 3-Input OR-NAND		7	1	#####			NAND	1.2	2.8	1.6	1.5	
NA4R3N								In-verter	1.8	1.2	1.5	0.9
4-Wide 4-Input OR-NAND		9	1	#####			NAND	1.7	3.7	1.6	1.5	
NA4R4N								In-verter	1.8	1.2	2.0	0.9
6-Wide 2-Input OR-NAND		8	1	@@@@@ @@@@@ @@@@@ @@@@@ @@@@@ @@@@@ @@@@@			NAND	1.4	1.2	1.6	0.9	
NA6R2N								In-verter	1.3	2.0	1.2	0.9

Macrocell		Equivalent Gate Count	Normalized Load Factor	Clamp Level When Open	Symbol	Symbol No.	Delay					
Function	Equivalent Circuit						Input Name	Output Name	t _{PLH} (ns)		t _{PHL} (ns)	
Function Name									t _{OLH}	K _{LH}	t _{OHL}	K _{HL}
8-Wide 2-Input OR-NAND		10	1	@@@ @@@ @@@ @@@ @@@ @@@ @@@ @@@ @@@ @@@		A5	NAND	1.5	1.2	1.6	0.9	
NA8R2N	Inverter							1.4	2.8	1.2	0.9	
2 AND OR-NAND		2	1	@ @ # @		A1	AND input	0.4	2.0	0.8	1.3	
NARA24	OR input						0.4	0.8				
	NAND input						0.4	0.7				
2 AND-NOR		2	1	@ @ #		A1	AND input	0.4	2.0	0.8	1.2	
NRA23	NOR input						0.3	0.7				
3 AND-NOR		2	1	@ @ @ #		A2	AND input	0.4	2.0	0.8	1.3	
NRA34	NOR input						0.3	0.7				
2 AND-3 NOR		2	1	@ @ # #		A2	AND input	0.5	2.8	0.8	1.2	
NRA24	NOR input						0.4	0.7				
2-Wide 2-Input AND-NOR		2	1	@ @ @ @		A1		0.4	2.0	0.8	1.2	
NR2A2												

Macrocell		Equiva- lent Gate Count	Normal- ized Load Factor	Clamp Level When Open	Symbol	Symbol No.	Input Name	Output Name	Delay			
Function	Equivalent Circuit								$t_{PLH}(ns)$		$t_{PHL}(ns)$	
Function Name									t_{OLH}	K_{LH}	t_{OHL}	K_{HL}
3-Wide 2-Input AND-NOR		3	1	@ @ @ @ @ @		A3			0.6	2.8	0.8	1.2
NR3A2												
2-Wide 3-Input AND-NOR		4	1	@ @ @ @ @ @		A2	NOR		0.6	2.0	1.0	1.3
NR2A3N											In- verter	
2-Wide 4-Input AND-NOR		5	1	@ @ @ @ @ @ @		A4	NOR		0.6	2.0	1.1	1.5
NR2A4N											In- verter	
3-Wide 3-Input AND-NOR		5	1	@ @ @ @ @ @ @			NOR		0.8	2.8	1.0	1.3
NR3A3N											In- verter	
3-Wide 4-Input AND-NOR		7	1	@ @ @ @ @ @ @ @ @			NOR		1.3	2.8	1.3	1.5
NR3A4N											In- verter	

Macrocell		Equivalent Gate Count	Normalized Load Factor	Clamp Level When Open	Symbol	Symbol No.	Delay					
Function	Equivalent Circuit						Input Name	Output Name	t _{PLH} (ns)		t _{PHL} (ns)	
Function Name									t _{OLH}	K _{LH}	t _{OHL}	K _{HL}
6-Wide 2-Input AND-NOR		8	1	# # # # # # # # # #			NOR	1.6	1.2	1.3	0.9	
NR6A2N	In-verter						1.0	1.2	1.4	1.2		
8-Wide 2-Input AND-NOR		10	1	# # # # # # # # # # #		A5	NOR	1.3	1.2	1.4	0.9	
NR8A2N	In-verter						1.6	1.2	1.6	0.9		
2 AND-OR-NAND		2	1	# # @ #		A1	OR input	0.5		1.2	1.2	
NRAR24	AND input						0.4	2.8	0.8			
	NOR input						0.3		0.7			

6. MULTIPLEXERS

Function	Macrocell				Symbol	Symbol No.	Delay						
	Function Name	Equivalent Circuit	Equivalent Gate Count	Normalized Load Factor			Clamp Level When Open	Input Name	Output Name	$t_{PLH}(ns)$		$t_{PHL}(ns)$	
										t_{OLH}	K_{LH}	t_{OHL}	K_{HL}
2 to 1 Multiplexer		3	1.2 1 1	# # #		B2	Y ₀	+Y	1.1	1.2	0.8	0.9	
M2T1N							Y ₁		1.1		0.8		
							S		1.3		1.2		
							Y ₀	-Y	0.5	2.0	0.9	1.2	
							Y ₁		0.5		0.9		
							S		0.9		1.1		
4 to 1 Multiplexer		9	1	# # # # #		B4	Y ₀	+Y	1.2	1.2	1.7	0.9	
M4T1N							Y ₁		1.2		1.7		
							Y ₂		1.2		1.7		
							Y ₃		1.2		1.7		
							A		2.5		2.7		
							Y ₀	-Y	1.4	3.7	1.0	1.3	
							Y ₁		1.4		1.0		
							Y ₂		1.4		1.0		
							Y ₃		1.4		1.0		
							A		2.4		2.3		
							B		2.4		2.3		
8 to 1 Multiplexer		21	1	# # # # # # # #		B ₆	Y ₀	+Y	1.7	1.2	2.0	1.3	
M8T1N							Y ₇		1.7		2.0		
							A, B, C		2.5		2.4		
							Y ₀	-Y	2.2	1.2	2.0	0.9	
							Y ₇		2.2		2.0		
							A, B, C		2.6		2.8		
1 to 2 Demultiplexer		4	1.2	# @		B3	Y	+0	1.2	1.2	0.8	0.9	
M1T2N							A		1.3		1.1		
							Y	+1	1.2	1.2	0.8	0.9	
							A		1.2		0.8		
							Y	-0	0.5	1.2	1.0	1.2	
							A		0.8		1.1		
							Y	-1	0.5	1.2	1.0	1.2	
							A		0.5		1.0		

7. DECODERS

Macrocell		Equiv- alent Gate Count	Normal- ized Load Factor	Clamp Level When Open	Symbol	Symbol No.	Delay					
Function	Equivalent Circuit						Input Name	Output Name	$t_{PLH}(ns)$		$t_{PHL}(ns)$	
Function Name									t_{OLH}	K_{LH}	t_{OHL}	K_{HL}
2-bit Decoder		8	1	# #		B5	A	-0	1.5	1.2	1.7	1.2
							B	-0	1.5	1.2	1.7	1.2
							A	-1	1.7	1.2	2.0	1.2
							B	-1	1.5	1.2	1.7	1.2
							A	-2	1.5	1.2	1.7	1.2
							B	-2	1.7	1.2	2.0	1.2
							A	-3	1.7	1.2	2.0	1.2
							B	-3	1.7	1.2	2.0	1.2
							A	+0	2.0	1.2	1.7	0.9
							B	+0	2.0	1.2	1.7	0.9
							A	+1	2.3	1.2	1.9	0.9
							B	+1	2.0	1.2	1.7	0.9
A	+2	2.0	1.2	1.7	0.9							
B	+2	2.3	1.2	1.9	0.9							
A	+3	2.3	1.2	1.9	0.9							
B	+3	2.3	1.2	1.9	0.9							
3-bit Decoder		1.4	1.8	# # #		B5	A	-0	1.4	1.2	1.2	1.3
							B	-1				
D3T8							C	-7				

8. LATCHES (with Scan Function)

Macrocell		Equivalent Gate Count	Normalized Load Factor	Clamp Level When Open	Symbol	Symbol No.	Delay																																			
Function	Truth table						Input Name	Output Name	$t_{PLH}(ns)$		$t_{PHL}(ns)$																															
Function Name									t_{OLH}	K_{LH}	t_{OHL}	K_{HL}																														
RS- Latch LRS0	<table border="1"> <tr><th>SN</th><th>RN</th><th>+Q</th><th>-Q</th></tr> <tr><td>0</td><td>0</td><td>0</td><td>0</td></tr> <tr><td>0</td><td>1</td><td>1</td><td>0</td></tr> <tr><td>1</td><td>0</td><td>0</td><td>1</td></tr> <tr><td>1</td><td>1</td><td colspan="2">Latch</td></tr> </table>	SN	RN	+Q	-Q	0	0	0	0	0	1	1	0	1	0	0	1	1	1	Latch		8	1	@		A3	\bar{S}	+Q	2.7	1.0	—	0.6										
		SN	RN	+Q	-Q																																					
		0	0	0	0																																					
		0	1	1	0																																					
1	0	0	1																																							
1	1	Latch																																								
\bar{R}	2.5	2.6																																								
\bar{S}	-Q	2.5	1.0	2.6	—	0.6																																				
\bar{R}		2.7																																								
RS- Latch LRS3	<table border="1"> <tr><th>S</th><th>R</th><th>+Q</th><th>-Q</th></tr> <tr><td>0</td><td>0</td><td colspan="2">Latch</td></tr> <tr><td>0</td><td>1</td><td>0</td><td>1</td></tr> <tr><td>1</td><td>0</td><td>1</td><td>0</td></tr> <tr><td>1</td><td>1</td><td>1</td><td>1</td></tr> </table>	S	R	+Q	-Q	0	0	Latch		0	1	0	1	1	0	1	0	1	1	1	1	8	1	#		A3	S	+Q	2.4	1.0	2.7	0.6										
		S	R	+Q	-Q																																					
		0	0	Latch																																						
		0	1	0	1																																					
1	0	1	0																																							
1	1	1	1																																							
R	—	3.3																																								
S	-Q	—	1.0	3.3	0.6																																					
R		2.4		2.7																																						
2-Input RS Latch LR2S20	<table border="1"> <tr><th>SN</th><th>RN</th><th>+Q</th><th>-Q</th></tr> <tr><td>0</td><td>0</td><td>0</td><td>0</td></tr> <tr><td>0</td><td>1</td><td>1</td><td>0</td></tr> <tr><td>1</td><td>0</td><td>0</td><td>1</td></tr> <tr><td>1</td><td>1</td><td colspan="2">Latch</td></tr> </table>	SN	RN	+Q	-Q	0	0	0	0	0	1	1	0	1	0	0	1	1	1	Latch		9	1	@		A4	\bar{S}	+Q	2.7	1.0	—	0.6										
		SN	RN	+Q	-Q																																					
		0	0	0	0																																					
		0	1	1	0																																					
1	0	0	1																																							
1	1	Latch																																								
\bar{R}	2.6	2.6																																								
\bar{S}	-Q	2.6	1.0	2.6	—	0.6																																				
\bar{R}		2.7																																								
2-Input RS Latch LR2S23	<table border="1"> <tr><th>S</th><th>R</th><th>+Q</th><th>-Q</th></tr> <tr><td>0</td><td>0</td><td colspan="2">Latch</td></tr> <tr><td>0</td><td>1</td><td>0</td><td>1</td></tr> <tr><td>1</td><td>0</td><td>1</td><td>0</td></tr> <tr><td>1</td><td>1</td><td>1</td><td>1</td></tr> </table>	S	R	+Q	-Q	0	0	Latch		0	1	0	1	1	0	1	0	1	1	1	1	9	1	#		A4	S	+Q	2.4	1.0	3.1	0.6										
		S	R	+Q	-Q																																					
		0	0	Latch																																						
		0	1	0	1																																					
1	0	1	0																																							
1	1	1	1																																							
R	—	3.7																																								
S	-Q	—	1.0	3.7	0.6																																					
R		2.4		3.1																																						
D-Latch LD	<table border="1"> <tr><th>G</th><th>+Q</th><th>-Q</th></tr> <tr><td>1</td><td>D</td><td>\bar{D}</td></tr> <tr><td>\downarrow</td><td colspan="2">Latch</td></tr> </table>	G	+Q	-Q	1	D	\bar{D}	\downarrow	Latch		5	1	@		C	G	+Q	3.2	1.2	2.9	0.9																					
		G	+Q	-Q																																						
		1	D	\bar{D}																																						
		\downarrow	Latch																																							
D	3.2	2.9																																								
G	-Q	2.6	1.2	2.9	0.9																																					
D		2.6		2.9																																						
D-Latch with CLR LDC1	<table border="1"> <tr><th>G</th><th>CL</th><th>+Q</th><th>-Q</th></tr> <tr><td>1</td><td>0</td><td>D</td><td>\bar{D}</td></tr> <tr><td>\downarrow</td><td>0</td><td colspan="2">Latch</td></tr> <tr><td>X</td><td>1</td><td>0</td><td>1</td></tr> </table> <p>X: Don't care</p>	G	CL	+Q	-Q	1	0	D	\bar{D}	\downarrow	0	Latch		X	1	0	1	6	1	@		C	G	+Q	3.5	1.2	3.4	0.9														
		G	CL	+Q	-Q																																					
		1	0	D	\bar{D}																																					
		\downarrow	0	Latch																																						
		X	1	0	1																																					
		CL	2.3	2.4																																						
D	-Q	3.5	1.2	3.4	0.9																																					
G		3.1		3.2																																						
CL	2.1	2.0																																								
D	3.1	3.2																																								
D-Latch with PRE LDP1	<table border="1"> <tr><th>G</th><th>PR</th><th>+Q</th><th>-Q</th></tr> <tr><td>1</td><td>0</td><td>D</td><td>\bar{D}</td></tr> <tr><td>\downarrow</td><td>0</td><td colspan="2">Latch</td></tr> <tr><td>X</td><td>1</td><td>1</td><td>0</td></tr> </table> <p>X: Don't care</p>	G	PR	+Q	-Q	1	0	D	\bar{D}	\downarrow	0	Latch		X	1	1	0	6	1	@		C	G	+Q	3.3	1.2	3.2	0.9														
		G	PR	+Q	-Q																																					
		1	0	D	\bar{D}																																					
		\downarrow	0	Latch																																						
		X	1	1	0																																					
		PR	2.4	2.5																																						
D	-Q	3.3	1.2	3.2	0.9																																					
G		2.9		3.0																																						
PR	2.2	2.1																																								
D	2.9	3.0																																								
D-Latch with PRE/ CLR LDPC3	<table border="1"> <tr><th>G</th><th>PR</th><th>CL</th><th>+Q</th><th>-Q</th></tr> <tr><td>1</td><td>0</td><td>0</td><td>D</td><td>\bar{D}</td></tr> <tr><td>\downarrow</td><td>0</td><td>0</td><td colspan="2">Latch</td></tr> <tr><td>X</td><td>1</td><td>0</td><td>1</td><td>0</td></tr> <tr><td>X</td><td>0</td><td>1</td><td>0</td><td>1</td></tr> <tr><td>X</td><td>1</td><td>1</td><td>0</td><td>1</td></tr> </table> <p>X: Don't care</p>	G	PR	CL	+Q	-Q	1	0	0	D	\bar{D}	\downarrow	0	0	Latch		X	1	0	1	0	X	0	1	0	1	X	1	1	0	1	7	1	@		C	G	+Q	3.8	1.2	3.5	0.9
		G	PR	CL	+Q	-Q																																				
		1	0	0	D	\bar{D}																																				
		\downarrow	0	0	Latch																																					
		X	1	0	1	0																																				
		X	0	1	0	1																																				
		X	1	1	0	1																																				
		PR	2.9	2.8																																						
CL	2.3	2.4																																								
D	3.8	3.5																																								
G	-Q	3.2	1.2	3.5	0.9																																					
PR		2.5		2.6																																						
CL		2.1		2.0																																						
D		3.2		3.5																																						

Macrocell		Equiva- lent Gate Count	Normal- ized Load Factor	Clamp Level When Open	Symbol	Symbol No.	Delay																				
Function	Truth table						Input Name	Output Name	$t_{PLH}(ns)$		$t_{PHL}(ns)$																
Function Name									t_{OLH}	k_{LH}	t_{OHL}	k_{HL}															
4-Bit D-Latch	<table border="1"> <tr> <td>G</td> <td>+Q₀</td> <td>+Q₁</td> <td>+Q₂</td> <td>+Q₃</td> </tr> <tr> <td>1</td> <td>D₀</td> <td>D₁</td> <td>D₂</td> <td>D₃</td> </tr> <tr> <td>\downarrow</td> <td colspan="4">Latch</td> </tr> </table>	G	+Q ₀	+Q ₁	+Q ₂	+Q ₃	1	D ₀	D ₁	D ₂	D ₃	\downarrow	Latch				20	1	@		B4	G	+Q ₀	3.5	1.2	3.2	0.9
G	+Q ₀	+Q ₁	+Q ₂	+Q ₃																							
1	D ₀	D ₁	D ₂	D ₃																							
\downarrow	Latch																										
LD4	<table border="1"> <tr> <td>\downarrow</td> <td colspan="4">Latch</td> </tr> </table>	\downarrow	Latch				D ₀	+Q ₃	3.2	2.9																	
		\downarrow	Latch																								
		D ₃	+Q ₀	3.6	3.2																						
D ₃	+Q ₃					3.3	2.9																				
		CL		3.0	2.7																						

9. FLIP-FLOPS (with Scan Function)

Macrocell		Equiva- lent Gate Count	Normal- ized Load Factor	Clamp Level When Open	Symbol	Symbol No.	Delay																																															
Function	Truth table						Input Name	Output Name	t_{PLH} (ns)		t_{PHL} (ns)																																											
Function Name									t_{OLH}	K_{LH}	t_{OHL}	K_{HL}																																										
DFF	<table border="1"> <tr><td>CK</td><td>+Q</td><td>-Q</td></tr> <tr><td>f</td><td>D</td><td>\bar{D}</td></tr> <tr><td>l</td><td>+Q₀</td><td>-Q₀</td></tr> </table>	CK	+Q	-Q	f	D	\bar{D}	l	+Q ₀	-Q ₀	7	1	@ @		C	CK	+Q	3.9	1.2	3.8	0.9																																	
CK	+Q	-Q																																																				
f	D	\bar{D}																																																				
l	+Q ₀	-Q ₀																																																				
FD								-Q	3.5	1.2	3.6	0.9																																										
DFF with Load FDL1	<table border="1"> <tr><td>CK</td><td>L</td><td>+Q</td><td>-Q</td></tr> <tr><td>f</td><td>0</td><td>D_C</td><td>\bar{D}_C</td></tr> <tr><td>f</td><td>1</td><td>D_L</td><td>\bar{D}_L</td></tr> <tr><td>l</td><td>x</td><td>+Q₀</td><td>-Q₀</td></tr> </table> <p>X:Don't care</p>	CK	L	+Q	-Q	f	0	D _C	\bar{D}_C	f	1	D _L	\bar{D}_L	l	x	+Q ₀	-Q ₀	9	1 1 1 1.2	@ @ @ #		C	CK	+Q	3.9	1.2	3.8	0.9																										
CK	L	+Q	-Q																																																			
f	0	D _C	\bar{D}_C																																																			
f	1	D _L	\bar{D}_L																																																			
l	x	+Q ₀	-Q ₀																																																			
								-Q	3.5	1.2	3.6	0.9																																										
DFF with CLR FDC1	<table border="1"> <tr><td>CK</td><td>CL</td><td>+Q</td><td>-Q</td></tr> <tr><td>f</td><td>0</td><td>D</td><td>\bar{D}</td></tr> <tr><td>l</td><td>0</td><td>+Q₀</td><td>-Q₀</td></tr> <tr><td>x</td><td>1</td><td>0</td><td>1</td></tr> </table> <p>X:Don't care</p>	CK	CL	+Q	-Q	f	0	D	\bar{D}	l	0	+Q ₀	-Q ₀	x	1	0	1	8	1 1 1.2	@ @ #		C	CK	+Q	4.0	1.2	4.1	0.9																										
CK	CL	+Q	-Q																																																			
f	0	D	\bar{D}																																																			
l	0	+Q ₀	-Q ₀																																																			
x	1	0	1																																																			
								CL	-	-	2.1	-																																										
								CK	-Q	3.8	1.2	3.7	0.9																																									
								CL	1.8	-	-	-																																										
DFF with PRE FDP1	<table border="1"> <tr><td>CK</td><td>PR</td><td>+Q</td><td>-Q</td></tr> <tr><td>f</td><td>0</td><td>D</td><td>\bar{D}</td></tr> <tr><td>l</td><td>0</td><td>+Q₀</td><td>-Q₀</td></tr> <tr><td>x</td><td>1</td><td>1</td><td>0</td></tr> </table> <p>X:Don't care</p>	CK	PR	+Q	-Q	f	0	D	\bar{D}	l	0	+Q ₀	-Q ₀	x	1	1	0	8	1 1 1.2	@ @ #		C	CK	+Q	4.4	1.2	4.1	0.9																										
CK	PR	+Q	-Q																																																			
f	0	D	\bar{D}																																																			
l	0	+Q ₀	-Q ₀																																																			
x	1	1	0																																																			
								RR	2.8	-	-	-																																										
								CK	-Q	3.8	1.2	4.1	0.9																																									
								PR	-	-	2.5	-																																										
DFF with PRE/ CLR FDPC3	<table border="1"> <tr><td>CK</td><td>PR</td><td>CL</td><td>+Q</td><td>-Q</td></tr> <tr><td>f</td><td>0</td><td>0</td><td>D</td><td>\bar{D}</td></tr> <tr><td>l</td><td>0</td><td>0</td><td>+Q₀</td><td>-Q₀</td></tr> <tr><td>x</td><td>1</td><td>0</td><td>1</td><td>0</td></tr> <tr><td>x</td><td>0</td><td>1</td><td>0</td><td>1</td></tr> <tr><td>x</td><td>1</td><td>1</td><td>0</td><td>1</td></tr> </table> <p>X:Don't care</p>	CK	PR	CL	+Q	-Q	f	0	0	D	\bar{D}	l	0	0	+Q ₀	-Q ₀	x	1	0	1	0	x	0	1	0	1	x	1	1	0	1	9	1 1 1.2 1.2	@ @ # #		C	CK	+Q	4.5	1.2	4.4	0.9												
CK	PR	CL	+Q	-Q																																																		
f	0	0	D	\bar{D}																																																		
l	0	0	+Q ₀	-Q ₀																																																		
x	1	0	1	0																																																		
x	0	1	0	1																																																		
x	1	1	0	1																																																		
								CL	2.0	-	2.1	-																																										
								PR	2.9	-	-	-																																										
								CK	-Q	4.1	1.2	4.2	0.9																																									
								CL	1.8	-	1.7	-																																										
								PR	-	-	2.6	-																																										
JKFF	<table border="1"> <tr><td>CK</td><td>J</td><td>K</td><td>+Q</td><td>-Q</td></tr> <tr><td>f</td><td>0</td><td>0</td><td>0</td><td>1</td></tr> <tr><td>f</td><td>1</td><td>1</td><td>1</td><td>0</td></tr> <tr><td>f</td><td>0</td><td>1</td><td>+Q₀</td><td>-Q₀</td></tr> <tr><td>f</td><td>1</td><td>0</td><td>-Q₀</td><td>+Q₀</td></tr> <tr><td>l</td><td>x</td><td>x</td><td>+Q₀</td><td>-Q₀</td></tr> </table> <p>X:Don't care</p>	CK	J	K	+Q	-Q	f	0	0	0	1	f	1	1	1	0	f	0	1	+Q ₀	-Q ₀	f	1	0	-Q ₀	+Q ₀	l	x	x	+Q ₀	-Q ₀	10	1.2 1 1	@ @ #		C	CK	+Q	3.7	1.2	4.4	0.9												
CK	J	K	+Q	-Q																																																		
f	0	0	0	1																																																		
f	1	1	1	0																																																		
f	0	1	+Q ₀	-Q ₀																																																		
f	1	0	-Q ₀	+Q ₀																																																		
l	x	x	+Q ₀	-Q ₀																																																		
FJ									-Q	3.6	1.2	4.4	0.9																																									
JKFF with CLR FJC1	<table border="1"> <tr><td>CK</td><td>J</td><td>K</td><td>CL</td><td>+Q</td><td>-Q</td></tr> <tr><td>f</td><td>0</td><td>0</td><td>0</td><td>0</td><td>1</td></tr> <tr><td>f</td><td>1</td><td>1</td><td>0</td><td>1</td><td>0</td></tr> <tr><td>f</td><td>0</td><td>1</td><td>0</td><td>+Q₀</td><td>-Q₀</td></tr> <tr><td>f</td><td>1</td><td>0</td><td>0</td><td>-Q₀</td><td>+Q₀</td></tr> <tr><td>l</td><td>x</td><td>x</td><td>0</td><td>+Q₀</td><td>-Q₀</td></tr> <tr><td>x</td><td>x</td><td>x</td><td>1</td><td>0</td><td>1</td></tr> </table> <p>X:Don't care</p>	CK	J	K	CL	+Q	-Q	f	0	0	0	0	1	f	1	1	0	1	0	f	0	1	0	+Q ₀	-Q ₀	f	1	0	0	-Q ₀	+Q ₀	l	x	x	0	+Q ₀	-Q ₀	x	x	x	1	0	1	13	1.2 1 1 1	@ @ # #		C	CK	+Q	4.3	1.2	4.6	0.9
CK	J	K	CL	+Q	-Q																																																	
f	0	0	0	0	1																																																	
f	1	1	0	1	0																																																	
f	0	1	0	+Q ₀	-Q ₀																																																	
f	1	0	0	-Q ₀	+Q ₀																																																	
l	x	x	0	+Q ₀	-Q ₀																																																	
x	x	x	1	0	1																																																	
								CL	-	-	4.8	-																																										
								CK	-Q	4.0	1.2	4.9	0.9																																									
								CL	3.5	-	-	-																																										

Macrocell		Equiva- lent Gate Count	Normal- ized Load Factor	Clamp Level When Open	Symbol	Symbol No.	Delay																																																																				
Function	Truth table						Input Name	Output Name	$t_{PLH}(ns)$		$t_{PHL}(ns)$																																																																
Function Name									t_{OLH}	k_{LH}	t_{OHL}	k_{HL}																																																															
JKFF with PRE/CLR	<table border="1"> <tr><th>CK</th><th>J</th><th>K</th><th>PR</th><th>CL</th><th>+Q</th><th>-Q</th></tr> <tr><td>f</td><td>0</td><td>0</td><td>1</td><td>0</td><td>0</td><td>1</td></tr> <tr><td>f</td><td>1</td><td>1</td><td>1</td><td>0</td><td>1</td><td>0</td></tr> <tr><td>f</td><td>0</td><td>1</td><td>1</td><td>0</td><td>+Q₀</td><td>Q₀</td></tr> <tr><td>f</td><td>1</td><td>0</td><td>1</td><td>0</td><td>-Q₀</td><td>+Q₀</td></tr> <tr><td>l</td><td>x</td><td>x</td><td>1</td><td>0</td><td>+Q₀</td><td>-Q₀</td></tr> <tr><td>x</td><td>x</td><td>x</td><td>0</td><td>0</td><td>1</td><td>0</td></tr> <tr><td>x</td><td>x</td><td>x</td><td>1</td><td>1</td><td>0</td><td>1</td></tr> <tr><td>x</td><td>x</td><td>x</td><td>0</td><td>1</td><td>1</td><td>1</td></tr> </table>	CK	J	K	PR	CL	+Q	-Q	f	0	0	1	0	0	1	f	1	1	1	0	1	0	f	0	1	1	0	+Q ₀	Q ₀	f	1	0	1	0	-Q ₀	+Q ₀	l	x	x	1	0	+Q ₀	-Q ₀	x	x	x	0	0	1	0	x	x	x	1	1	0	1	x	x	x	0	1	1	1	14	1.2 1 1	@ @ #		C	CK	+Q	4.3		4.6	
CK	J	K	PR	CL	+Q	-Q																																																																					
f	0	0	1	0	0	1																																																																					
f	1	1	1	0	1	0																																																																					
f	0	1	1	0	+Q ₀	Q ₀																																																																					
f	1	0	1	0	-Q ₀	+Q ₀																																																																					
l	x	x	1	0	+Q ₀	-Q ₀																																																																					
x	x	x	0	0	1	0																																																																					
x	x	x	1	1	0	1																																																																					
x	x	x	0	1	1	1																																																																					
FJPC1	X:Don't care		1.2 1	@ #			PR	+Q	2.6	1.2	2.6	0.9																																																															
							CL	-Q	-		4.8																																																																
							CK	-Q	4.1		4.9																																																																
							PR	-Q	-	1.2	4.6	0.9																																																															
							CL	-Q	3.6		2.6																																																																
TFF with CLR	<table border="1"> <tr><th>CK</th><th>CL</th><th>+Q</th><th>-Q</th></tr> <tr><td>f</td><td>0</td><td>-Q₀</td><td>+Q₀</td></tr> <tr><td>l</td><td>0</td><td>+Q₀</td><td>-Q₀</td></tr> <tr><td>x</td><td>1</td><td>0</td><td>1</td></tr> </table>	CK	CL	+Q	-Q	f	0	-Q ₀	+Q ₀	l	0	+Q ₀	-Q ₀	x	1	0	1	9	1 1.2	@ #		C	CK	+Q	4.0	1.2	4.1	0.9																																															
CK	CL	+Q	-Q																																																																								
f	0	-Q ₀	+Q ₀																																																																								
l	0	+Q ₀	-Q ₀																																																																								
x	1	0	1																																																																								
FTC1	X:Don't care						CL	-Q	-		2.1																																																																
							CK	-Q	3.8	1.2	3.7	0.9																																																															
							CL	-Q	1.8		-																																																																
TFF with PRE	<table border="1"> <tr><th>CK</th><th>PR</th><th>+Q</th><th>-Q</th></tr> <tr><td>f</td><td>0</td><td>-Q₀</td><td>+Q₀</td></tr> <tr><td>l</td><td>0</td><td>+Q₀</td><td>-Q₀</td></tr> <tr><td>x</td><td>1</td><td>1</td><td>0</td></tr> </table>	CK	PR	+Q	-Q	f	0	-Q ₀	+Q ₀	l	0	+Q ₀	-Q ₀	x	1	1	0	9	1 1.2	@ #		C	CK	+Q	4.4	1.2	4.1	0.9																																															
CK	PR	+Q	-Q																																																																								
f	0	-Q ₀	+Q ₀																																																																								
l	0	+Q ₀	-Q ₀																																																																								
x	1	1	0																																																																								
FTP1	X:Don't care						PR	+Q	2.8		-																																																																
							CK	-Q	3.8	1.2	4.1	0.9																																																															
							PR	-Q	-		2.5																																																																
TFF with PRE/CLR	<table border="1"> <tr><th>CK</th><th>PR</th><th>CL</th><th>+Q</th><th>-Q</th></tr> <tr><td>f</td><td>0</td><td>0</td><td>-Q₀</td><td>+Q₀</td></tr> <tr><td>l</td><td>0</td><td>0</td><td>+Q₀</td><td>-Q₀</td></tr> <tr><td>x</td><td>1</td><td>0</td><td>1</td><td>0</td></tr> <tr><td>x</td><td>0</td><td>1</td><td>0</td><td>1</td></tr> <tr><td>x</td><td>1</td><td>1</td><td>0</td><td>1</td></tr> </table>	CK	PR	CL	+Q	-Q	f	0	0	-Q ₀	+Q ₀	l	0	0	+Q ₀	-Q ₀	x	1	0	1	0	x	0	1	0	1	x	1	1	0	1	10	1 1.2 1.2	@ # #		C	CK	+Q	4.5	1.2	4.4	0.9																																	
CK	PR	CL	+Q	-Q																																																																							
f	0	0	-Q ₀	+Q ₀																																																																							
l	0	0	+Q ₀	-Q ₀																																																																							
x	1	0	1	0																																																																							
x	0	1	0	1																																																																							
x	1	1	0	1																																																																							
FTPC3	X:Don't care						PR	+Q	2.9		-																																																																
							CL	+Q	2.0		2.1																																																																
							CK	-Q	4.1		4.2																																																																
							PR	-Q	-	1.2	2.6	0.9																																																															
							CL	-Q	1.8		1.7																																																																
4-Bit DFF	<table border="1"> <tr><th>CK</th><th>+Q₀</th><th>+Q₁</th><th>+Q₂</th><th>+Q₃</th></tr> <tr><td>f</td><td>D₀</td><td>D₁</td><td>D₂</td><td>D₃</td></tr> <tr><td>l</td><td>+Q₀₀</td><td>+Q₁₀</td><td>+Q₂₀</td><td>+Q₃₀</td></tr> </table>	CK	+Q ₀	+Q ₁	+Q ₂	+Q ₃	f	D ₀	D ₁	D ₂	D ₃	l	+Q ₀₀	+Q ₁₀	+Q ₂₀	+Q ₃₀	28	1 1 1 1	@ @ @ @		B4	CK	+Q ₀	4.1	1.2	4.0	0.9																																																
CK	+Q ₀	+Q ₁	+Q ₂	+Q ₃																																																																							
f	D ₀	D ₁	D ₂	D ₃																																																																							
l	+Q ₀₀	+Q ₁₀	+Q ₂₀	+Q ₃₀																																																																							
FD4								+Q ₃																																																																			
4-Bit DFF with CLR	<table border="1"> <tr><th>CK</th><th>CL</th><th>+Q₀</th><th>+Q₁</th><th>+Q₂</th><th>+Q₃</th></tr> <tr><td>f</td><td>0</td><td>D₀</td><td>D₁</td><td>D₂</td><td>D₃</td></tr> <tr><td>l</td><td>0</td><td>+Q₀₀</td><td>+Q₁₀</td><td>+Q₂₀</td><td>+Q₃₀</td></tr> <tr><td>x</td><td>1</td><td>0</td><td>0</td><td>0</td><td>0</td></tr> </table>	CK	CL	+Q ₀	+Q ₁	+Q ₂	+Q ₃	f	0	D ₀	D ₁	D ₂	D ₃	l	0	+Q ₀₀	+Q ₁₀	+Q ₂₀	+Q ₃₀	x	1	0	0	0	0	33	1 1 1 1	@ @ @ #		B4	CK	+Q ₀	4.4	1.2	4.3	0.9																																							
CK	CL	+Q ₀	+Q ₁	+Q ₂	+Q ₃																																																																						
f	0	D ₀	D ₁	D ₂	D ₃																																																																						
l	0	+Q ₀₀	+Q ₁₀	+Q ₂₀	+Q ₃₀																																																																						
x	1	0	0	0	0																																																																						
FD4C1	X:Don't care							+Q ₃																																																																			
								CL	-		3.3																																																																

10. SHIFT REGISTERS (with Scan Function)

Macrocell		Equiva- lent Gate Count	Normal- ized Load Factor	Clamp Level When Open	Symbol	Symbol No.	Delay																																																																				
Function	Truth table						Input Name	Output Name	t _{PLH} (ns)		t _{PHL} (ns)																																																																
Function Name									t _{OLH}	k _{LH}	t _{OHL}	k _{HL}																																																															
2-Bit SR	<table border="1"> <tr><td>CK</td><td>+A</td><td>+B</td></tr> <tr><td>f</td><td>D</td><td>+A₀</td></tr> <tr><td>l</td><td>+A₀</td><td>+B₀</td></tr> </table>	CK	+A	+B	f	D	+A ₀	l	+A ₀	+B ₀	12	1 1	@ @		B1	CK	+A	4.1	1.2	4.0	0.9																																																						
CK	+A	+B																																																																									
f	D	+A ₀																																																																									
l	+A ₀	+B ₀																																																																									
ZSR								+B	4.1	1.2	4.0	0.9																																																															
2-Bit SR with CLR	<table border="1"> <tr><td>CK</td><td>CLA</td><td>CLB</td><td>+A</td><td>+B</td></tr> <tr><td>f</td><td>0</td><td>0</td><td>D</td><td>+A₀</td></tr> <tr><td>l</td><td>0</td><td>0</td><td>+A₀</td><td>+B₀</td></tr> <tr><td>x</td><td>1</td><td>x</td><td>0</td><td>x</td></tr> <tr><td>x</td><td>x</td><td>1</td><td>x</td><td>0</td></tr> </table> <p>X:Don't care</p>	CK	CLA	CLB	+A	+B	f	0	0	D	+A ₀	l	0	0	+A ₀	+B ₀	x	1	x	0	x	x	x	1	x	0	15	1 1.2 1.2	@ @ # #		C	CK	+A	2.4	1.2	2.6	0.9																																						
CK	CLA	CLB	+A	+B																																																																							
f	0	0	D	+A ₀																																																																							
l	0	0	+A ₀	+B ₀																																																																							
x	1	x	0	x																																																																							
x	x	1	x	0																																																																							
ZSRC1								CLA	-	-	2.5	-																																																															
								CK	+B	2.4	1.2	2.6	0.9																																																														
								CLB	-	-	2.5	-																																																															
2-Bit SR with CLR/PRE	<table border="1"> <tr><td>CK</td><td>CLA</td><td>CLB</td><td>PRA</td><td>PRB</td><td>+A</td><td>+B</td></tr> <tr><td>f</td><td>0</td><td>0</td><td>0</td><td>0</td><td>D</td><td>+A₀</td></tr> <tr><td>l</td><td>0</td><td>0</td><td>0</td><td>0</td><td>+A₀</td><td>+B₀</td></tr> <tr><td>x</td><td>1</td><td>x</td><td>x</td><td>x</td><td>0</td><td>x</td></tr> <tr><td>x</td><td>x</td><td>1</td><td>x</td><td>x</td><td>x</td><td>0</td></tr> <tr><td>x</td><td>x</td><td>x</td><td>1</td><td>x</td><td>1</td><td>x</td></tr> <tr><td>x</td><td>x</td><td>x</td><td>x</td><td>1</td><td>x</td><td>1</td></tr> <tr><td>x</td><td>1</td><td>x</td><td>1</td><td>x</td><td>0</td><td>x</td></tr> <tr><td>x</td><td>x</td><td>1</td><td>x</td><td>1</td><td>x</td><td>0</td></tr> </table> <p>X:Don't care</p>	CK	CLA	CLB	PRA	PRB	+A	+B	f	0	0	0	0	D	+A ₀	l	0	0	0	0	+A ₀	+B ₀	x	1	x	x	x	0	x	x	x	1	x	x	x	0	x	x	x	1	x	1	x	x	x	x	x	1	x	1	x	1	x	1	x	0	x	x	x	1	x	1	x	0	17	1 1.2 1.2 1.2 1.2	@ @ # # # #		B4	CK	+A	4.7	1.2	4.6	0.9
CK	CLA	CLB	PRA	PRB	+A	+B																																																																					
f	0	0	0	0	D	+A ₀																																																																					
l	0	0	0	0	+A ₀	+B ₀																																																																					
x	1	x	x	x	0	x																																																																					
x	x	1	x	x	x	0																																																																					
x	x	x	1	x	1	x																																																																					
x	x	x	x	1	x	1																																																																					
x	1	x	1	x	0	x																																																																					
x	x	1	x	1	x	0																																																																					
ZSRCP3								CLA	+A	2.0	1.2	2.1	0.9																																																														
								PRA	-	-	-	-																																																															
								CK	+B	4.7	1.2	4.6	0.9																																																														
								CLB	+B	2.0	1.2	2.1	0.9																																																														
								PRB	-	-	-	-																																																															
4-Bit SR	<table border="1"> <tr><td>CK</td><td>+A</td><td>+B</td><td>+C</td><td>+D</td></tr> <tr><td>f</td><td>D</td><td>+A₀</td><td>+B₀</td><td>+C₀</td></tr> <tr><td>l</td><td>+A₀</td><td>+B₀</td><td>+C₀</td><td>+D₀</td></tr> </table>	CK	+A	+B	+C	+D	f	D	+A ₀	+B ₀	+C ₀	l	+A ₀	+B ₀	+C ₀	+D ₀	28	1 1	@ @		C	CK	+A	4.2	1.2	4.1	0.9																																																
CK	+A	+B	+C	+D																																																																							
f	D	+A ₀	+B ₀	+C ₀																																																																							
l	+A ₀	+B ₀	+C ₀	+D ₀																																																																							
ZSR4								+B	4.2	1.2	4.1	0.9																																																															
								+C	4.2	1.2	4.1	0.9																																																															
								+D	4.2	1.2	4.1	0.9																																																															
4-Bit SR with CLR	<table border="1"> <tr><td>CK</td><td>CLA</td><td>CLB</td><td>CLC</td><td>CLD</td><td>+A</td><td>+B</td><td>+C</td><td>+D</td></tr> <tr><td>f</td><td>0</td><td>0</td><td>0</td><td>0</td><td>D</td><td>+A₀</td><td>+B₀</td><td>+C₀</td></tr> <tr><td>l</td><td>0</td><td>0</td><td>0</td><td>0</td><td>+A₀</td><td>+B₀</td><td>+C₀</td><td>+D₀</td></tr> <tr><td>x</td><td>1</td><td>x</td><td>x</td><td>x</td><td>0</td><td>x</td><td>x</td><td>x</td></tr> <tr><td>x</td><td>x</td><td>1</td><td>x</td><td>x</td><td>x</td><td>0</td><td>x</td><td>x</td></tr> <tr><td>x</td><td>x</td><td>x</td><td>1</td><td>x</td><td>x</td><td>x</td><td>0</td><td>x</td></tr> <tr><td>x</td><td>x</td><td>x</td><td>x</td><td>1</td><td>x</td><td>x</td><td>x</td><td>0</td></tr> </table> <p>X:Don't care</p>	CK	CLA	CLB	CLC	CLD	+A	+B	+C	+D	f	0	0	0	0	D	+A ₀	+B ₀	+C ₀	l	0	0	0	0	+A ₀	+B ₀	+C ₀	+D ₀	x	1	x	x	x	0	x	x	x	x	x	1	x	x	x	0	x	x	x	x	x	1	x	x	x	0	x	x	x	x	x	1	x	x	x	0	36	1 1.2 1.2 1.2 1.2	@ @ # # # #		B4	CK	+A	4.5	1.2	4.4	0.9
CK	CLA	CLB	CLC	CLD	+A	+B	+C	+D																																																																			
f	0	0	0	0	D	+A ₀	+B ₀	+C ₀																																																																			
l	0	0	0	0	+A ₀	+B ₀	+C ₀	+D ₀																																																																			
x	1	x	x	x	0	x	x	x																																																																			
x	x	1	x	x	x	0	x	x																																																																			
x	x	x	1	x	x	x	0	x																																																																			
x	x	x	x	1	x	x	x	0																																																																			
ZSR4C1								CLA	-	-	2.1	-																																																															
								CK	+B	4.5	1.2	4.4	0.9																																																														
								CLB	-	-	2.1	-																																																															
								CK	+C	4.5	1.2	4.4	0.9																																																														
								CLC	-	-	2.1	-																																																															
								CK	+D	4.5	1.2	4.4	0.9																																																														
								CLD	-	-	2.1	-																																																															

11. Latches (Normal Type)

Macrocell		Equivalent Gate Count	Normalized Load Factor	Clamp Level When Open	Symbol	Symbol No.	Delay																																			
Function	Truth table						t _{PLH} (ns)		t _{PHL} (ns)																																	
Function Name							t _{OLH}	k _{LH}	t _{OHL}	k _{HL}																																
RS latch	<table border="1"> <tr><th>SN</th><th>RN</th><th>+Q</th><th>-Q</th></tr> <tr><td>0</td><td>0</td><td>0</td><td>0</td></tr> <tr><td>0</td><td>1</td><td>1</td><td>0</td></tr> <tr><td>1</td><td>0</td><td>0</td><td>1</td></tr> <tr><td>1</td><td>1</td><td colspan="2">Latch</td></tr> </table>	SN	RN	+Q	-Q	0	0	0	0	0	1	1	0	1	0	0	1	1	1	Latch		3	1	@		A3	S̄	+Q	1.2	1.2	—	0.9										
SN	RN	+Q	-Q																																							
0	0	0	0																																							
0	1	1	0																																							
1	0	0	1																																							
1	1	Latch																																								
R̄	1.0	0.9																																								
LRS0	<table border="1"> <tr><th>SN</th><th>RN</th><th>+Q</th><th>-Q</th></tr> <tr><td>0</td><td>0</td><td>0</td><td>0</td></tr> <tr><td>0</td><td>1</td><td>1</td><td>0</td></tr> <tr><td>1</td><td>0</td><td>0</td><td>1</td></tr> <tr><td>1</td><td>1</td><td colspan="2">Latch</td></tr> </table>	SN	RN	+Q	-Q	0	0	0	0	0	1	1	0	1	0	0	1	1	1	Latch		3	1	@		A3	S̄	-Q	1.0	1.2	0.9	0.9										
		SN	RN	+Q	-Q																																					
0	0	0	0																																							
0	1	1	0																																							
1	0	0	1																																							
1	1	Latch																																								
R̄	1.2	—																																								
RS latch	<table border="1"> <tr><th>S</th><th>R</th><th>+Q</th><th>-Q</th></tr> <tr><td>0</td><td>0</td><td colspan="2">Latch</td></tr> <tr><td>0</td><td>1</td><td>0</td><td>1</td></tr> <tr><td>1</td><td>0</td><td>1</td><td>0</td></tr> <tr><td>1</td><td>1</td><td>1</td><td>1</td></tr> </table>	S	R	+Q	-Q	0	0	Latch		0	1	0	1	1	0	1	0	1	1	1	1	3	1	#		A3	S	+Q	0.9	1.2	1.0	0.9										
S	R	+Q	-Q																																							
0	0	Latch																																								
0	1	0	1																																							
1	0	1	0																																							
1	1	1	1																																							
R	—	1.6																																								
LRS3	<table border="1"> <tr><th>S</th><th>R</th><th>+Q</th><th>-Q</th></tr> <tr><td>0</td><td>0</td><td colspan="2">Latch</td></tr> <tr><td>0</td><td>1</td><td>0</td><td>1</td></tr> <tr><td>1</td><td>0</td><td>1</td><td>0</td></tr> <tr><td>1</td><td>1</td><td>1</td><td>1</td></tr> </table>	S	R	+Q	-Q	0	0	Latch		0	1	0	1	1	0	1	0	1	1	1	1	3	1	#		A3	S	-Q	—	1.2	1.6	0.9										
		S	R	+Q	-Q																																					
0	0	Latch																																								
0	1	0	1																																							
1	0	1	0																																							
1	1	1	1																																							
R	0.9	1.0																																								
2-Input RS latch	<table border="1"> <tr><th>SN</th><th>RN</th><th>+Q</th><th>-Q</th></tr> <tr><td>0</td><td>0</td><td>0</td><td>0</td></tr> <tr><td>0</td><td>1</td><td>1</td><td>0</td></tr> <tr><td>1</td><td>0</td><td>0</td><td>1</td></tr> <tr><td>1</td><td>1</td><td colspan="2">Latch</td></tr> </table>	SN	RN	+Q	-Q	0	0	0	0	0	1	1	0	1	0	0	1	1	1	Latch		4	1	@		A4	S̄	+Q	1.2	1.2	—	0.9										
SN	RN	+Q	-Q																																							
0	0	0	0																																							
0	1	1	0																																							
1	0	0	1																																							
1	1	Latch																																								
R̄	1.1	0.9																																								
LR2S20	<table border="1"> <tr><th>SN</th><th>RN</th><th>+Q</th><th>-Q</th></tr> <tr><td>0</td><td>0</td><td>0</td><td>0</td></tr> <tr><td>0</td><td>1</td><td>1</td><td>0</td></tr> <tr><td>1</td><td>0</td><td>0</td><td>1</td></tr> <tr><td>1</td><td>1</td><td colspan="2">Latch</td></tr> </table>	SN	RN	+Q	-Q	0	0	0	0	0	1	1	0	1	0	0	1	1	1	Latch		4	1	@		A4	S̄	-Q	1.1	1.2	0.9	0.9										
		SN	RN	+Q	-Q																																					
0	0	0	0																																							
0	1	1	0																																							
1	0	0	1																																							
1	1	Latch																																								
R̄	1.2	—																																								
2-Input RS latch	<table border="1"> <tr><th>S</th><th>R</th><th>+Q</th><th>-Q</th></tr> <tr><td>0</td><td>0</td><td colspan="2">Latch</td></tr> <tr><td>0</td><td>1</td><td>0</td><td>1</td></tr> <tr><td>1</td><td>0</td><td>1</td><td>0</td></tr> <tr><td>1</td><td>1</td><td>1</td><td>1</td></tr> </table>	S	R	+Q	-Q	0	0	Latch		0	1	0	1	1	0	1	0	1	1	1	1	4	1	#		A4	S	+Q	0.9	1.2	1.4	0.9										
S	R	+Q	-Q																																							
0	0	Latch																																								
0	1	0	1																																							
1	0	1	0																																							
1	1	1	1																																							
R	—	2.0																																								
LR2S23	<table border="1"> <tr><th>S</th><th>R</th><th>+Q</th><th>-Q</th></tr> <tr><td>0</td><td>0</td><td colspan="2">Latch</td></tr> <tr><td>0</td><td>1</td><td>0</td><td>1</td></tr> <tr><td>1</td><td>0</td><td>1</td><td>0</td></tr> <tr><td>1</td><td>1</td><td>1</td><td>1</td></tr> </table>	S	R	+Q	-Q	0	0	Latch		0	1	0	1	1	0	1	0	1	1	1	1	4	1	#		A4	S	-Q	—	1.2	2.0	0.9										
		S	R	+Q	-Q																																					
0	0	Latch																																								
0	1	0	1																																							
1	0	1	0																																							
1	1	1	1																																							
R	0.9	1.4																																								
D latch	<table border="1"> <tr><th>G</th><th>+Q</th><th>-Q</th></tr> <tr><td>1</td><td>D</td><td>D̄</td></tr> <tr><td>↓</td><td colspan="2">Latch</td></tr> </table>	G	+Q	-Q	1	D	D̄	↓	Latch		4	1	@		C	G	+Q	1.5	1.2	1.5	0.9																					
G	+Q	-Q																																								
1	D	D̄																																								
↓	Latch																																									
D	1.5	1.5																																								
LD	<table border="1"> <tr><th>G</th><th>+Q</th><th>-Q</th></tr> <tr><td>1</td><td>D</td><td>D̄</td></tr> <tr><td>↓</td><td colspan="2">Latch</td></tr> </table>	G	+Q	-Q	1	D	D̄	↓	Latch		4	1	@		C	G	-Q	1.6	1.2	1.8	0.9																					
		G	+Q	-Q																																						
1	D	D̄																																								
↓	Latch																																									
D	1.6	1.8																																								
D latch with CLR	<table border="1"> <tr><th>G</th><th>CL</th><th>+Q</th><th>-Q</th></tr> <tr><td>1</td><td>0</td><td>D</td><td>D̄</td></tr> <tr><td>↓</td><td>0</td><td colspan="2">Latch</td></tr> <tr><td>X</td><td>1</td><td>0</td><td>1</td></tr> </table> <p>X: Don't care</p>	G	CL	+Q	-Q	1	0	D	D̄	↓	0	Latch		X	1	0	1	5	1	@		C	G	+Q	2.8	1.2	2.4	0.9														
G	CL	+Q	-Q																																							
1	0	D	D̄																																							
↓	0	Latch																																								
X	1	0	1																																							
CL	1.6	1.4																																								
LDC1	<table border="1"> <tr><th>G</th><th>CL</th><th>+Q</th><th>-Q</th></tr> <tr><td>1</td><td>0</td><td>D</td><td>D̄</td></tr> <tr><td>↓</td><td>0</td><td colspan="2">Latch</td></tr> <tr><td>X</td><td>1</td><td>0</td><td>1</td></tr> </table> <p>X: Don't care</p>	G	CL	+Q	-Q	1	0	D	D̄	↓	0	Latch		X	1	0	1	5	1	@		C	D	+Q	2.8	1.2	2.4	0.9														
		G	CL	+Q	-Q																																					
		1	0	D	D̄																																					
		↓	0	Latch																																						
X	1	0	1																																							
G	2.1	2.8																																								
LDC1	<table border="1"> <tr><th>G</th><th>CL</th><th>+Q</th><th>-Q</th></tr> <tr><td>1</td><td>0</td><td>D</td><td>D̄</td></tr> <tr><td>↓</td><td>0</td><td colspan="2">Latch</td></tr> <tr><td>X</td><td>1</td><td>0</td><td>1</td></tr> </table> <p>X: Don't care</p>	G	CL	+Q	-Q	1	0	D	D̄	↓	0	Latch		X	1	0	1	5	1	#		C	G	-Q	1.1	1.2	1.6	0.9														
		G	CL	+Q	-Q																																					
1	0	D	D̄																																							
↓	0	Latch																																								
X	1	0	1																																							
D	2.1	2.8																																								
D latch with PRE	<table border="1"> <tr><th>G</th><th>PR</th><th>+Q</th><th>-Q</th></tr> <tr><td>1</td><td>0</td><td>D</td><td>D̄</td></tr> <tr><td>↓</td><td>0</td><td colspan="2">Latch</td></tr> <tr><td>X</td><td>1</td><td>1</td><td>0</td></tr> </table> <p>X: Don't care</p>	G	PR	+Q	-Q	1	0	D	D̄	↓	0	Latch		X	1	1	0	5	1	@		C	G	+Q	1.6	1.2	1.8	0.9														
G	PR	+Q	-Q																																							
1	0	D	D̄																																							
↓	0	Latch																																								
X	1	1	0																																							
PR	0.7	1.1																																								
LDP1	<table border="1"> <tr><th>G</th><th>PR</th><th>+Q</th><th>-Q</th></tr> <tr><td>1</td><td>0</td><td>D</td><td>D̄</td></tr> <tr><td>↓</td><td>0</td><td colspan="2">Latch</td></tr> <tr><td>X</td><td>1</td><td>1</td><td>0</td></tr> </table> <p>X: Don't care</p>	G	PR	+Q	-Q	1	0	D	D̄	↓	0	Latch		X	1	1	0	5	1	@		C	D	+Q	1.6	1.2	1.8	0.9														
		G	PR	+Q	-Q																																					
		1	0	D	D̄																																					
		↓	0	Latch																																						
X	1	1	0																																							
G	1.9	1.9																																								
LDP1	<table border="1"> <tr><th>G</th><th>PR</th><th>+Q</th><th>-Q</th></tr> <tr><td>1</td><td>0</td><td>D</td><td>D̄</td></tr> <tr><td>↓</td><td>0</td><td colspan="2">Latch</td></tr> <tr><td>X</td><td>1</td><td>1</td><td>0</td></tr> </table> <p>X: Don't care</p>	G	PR	+Q	-Q	1	0	D	D̄	↓	0	Latch		X	1	1	0	5	1	#		C	G	-Q	1.2	1.2	1.0	0.9														
		G	PR	+Q	-Q																																					
1	0	D	D̄																																							
↓	0	Latch																																								
X	1	1	0																																							
D	1.9	1.9																																								
D latch with PRE/CLR	<table border="1"> <tr><th>G</th><th>PR</th><th>CL</th><th>+Q</th><th>-Q</th></tr> <tr><td>1</td><td>0</td><td>0</td><td>D</td><td>D̄</td></tr> <tr><td>↓</td><td>0</td><td>0</td><td colspan="2">Latch</td></tr> <tr><td>X</td><td>1</td><td>0</td><td>1</td><td>0</td></tr> <tr><td>X</td><td>0</td><td>1</td><td>0</td><td>1</td></tr> <tr><td>X</td><td>1</td><td>1</td><td>0</td><td>1</td></tr> </table> <p>X: Don't care</p>	G	PR	CL	+Q	-Q	1	0	0	D	D̄	↓	0	0	Latch		X	1	0	1	0	X	0	1	0	1	X	1	1	0	1	6	1	@		C	G	+Q	3.1	1.2	2.5	0.9
G	PR	CL	+Q	-Q																																						
1	0	0	D	D̄																																						
↓	0	0	Latch																																							
X	1	0	1	0																																						
X	0	1	0	1																																						
X	1	1	0	1																																						
PR	2.2	1.8																																								
LDPC3	<table border="1"> <tr><th>G</th><th>PR</th><th>CL</th><th>+Q</th><th>-Q</th></tr> <tr><td>1</td><td>0</td><td>0</td><td>D</td><td>D̄</td></tr> <tr><td>↓</td><td>0</td><td>0</td><td colspan="2">Latch</td></tr> <tr><td>X</td><td>1</td><td>0</td><td>1</td><td>0</td></tr> <tr><td>X</td><td>0</td><td>1</td><td>0</td><td>1</td></tr> <tr><td>X</td><td>1</td><td>1</td><td>0</td><td>1</td></tr> </table> <p>X: Don't care</p>	G	PR	CL	+Q	-Q	1	0	0	D	D̄	↓	0	0	Latch		X	1	0	1	0	X	0	1	0	1	X	1	1	0	1	6	1	@		C	CL	+Q	1.6	1.2	1.4	0.9
		G	PR	CL	+Q	-Q																																				
		1	0	0	D	D̄																																				
		↓	0	0	Latch																																					
X	1	0	1	0																																						
X	0	1	0	1																																						
X	1	1	0	1																																						
D	3.1	2.5																																								
LDPC3	<table border="1"> <tr><th>G</th><th>PR</th><th>CL</th><th>+Q</th><th>-Q</th></tr> <tr><td>1</td><td>0</td><td>0</td><td>D</td><td>D̄</td></tr> <tr><td>↓</td><td>0</td><td>0</td><td colspan="2">Latch</td></tr> <tr><td>X</td><td>1</td><td>0</td><td>1</td><td>0</td></tr> <tr><td>X</td><td>0</td><td>1</td><td>0</td><td>1</td></tr> <tr><td>X</td><td>1</td><td>1</td><td>0</td><td>1</td></tr> </table> <p>X: Don't care</p>	G	PR	CL	+Q	-Q	1	0	0	D	D̄	↓	0	0	Latch		X	1	0	1	0	X	0	1	0	1	X	1	1	0	1	6	1	#		C	G	-Q	2.2	1.2	2.9	0.9
		G	PR	CL	+Q	-Q																																				
1	0	0	D	D̄																																						
↓	0	0	Latch																																							
X	1	0	1	0																																						
X	0	1	0	1																																						
X	1	1	0	1																																						
PR	1.5	2.0																																								
LDPC3	<table border="1"> <tr><th>G</th><th>PR</th><th>CL</th><th>+Q</th><th>-Q</th></tr> <tr><td>1</td><td>0</td><td>0</td><td>D</td><td>D̄</td></tr> <tr><td>↓</td><td>0</td><td>0</td><td colspan="2">Latch</td></tr> <tr><td>X</td><td>1</td><td>0</td><td>1</td><td>0</td></tr> <tr><td>X</td><td>0</td><td>1</td><td>0</td><td>1</td></tr> <tr><td>X</td><td>1</td><td>1</td><td>0</td><td>1</td></tr> </table> <p>X: Don't care</p>	G	PR	CL	+Q	-Q	1	0	0	D	D̄	↓	0	0	Latch		X	1	0	1	0	X	0	1	0	1	X	1	1	0	1	6	1	#		C	CL	-Q	1.1	1.2	1.4	0.9
		G	PR	CL	+Q	-Q																																				
1	0	0	D	D̄																																						
↓	0	0	Latch																																							
X	1	0	1	0																																						
X	0	1	0	1																																						
X	1	1	0	1																																						
D	2.2	2.9																																								

Macrocell		Equivalent Gate Count	Normalized Load Factor	Clamp Level When Open	Symbol	Symbol No.	Delay																													
Function	Truth table						Input Name	Output Name	$t_{PLH}(ns)$		$t_{PHL}(ns)$																									
Function Name									t_{OLH}	k_{LH}	t_{OHL}	k_{HL}																								
4-Bit D latch LD4	<table border="1"> <tr> <th>G</th> <th>+Q₀</th> <th>+Q₁</th> <th>+Q₂</th> <th>+Q₃</th> </tr> <tr> <td>1</td> <td>D₀</td> <td>D₁</td> <td>D₂</td> <td>D₃</td> </tr> <tr> <td>$\bar{1}$</td> <td colspan="4">Latch</td> </tr> </table>	G	+Q ₀	+Q ₁	+Q ₂	+Q ₃	1	D ₀	D ₁	D ₂	D ₃	$\bar{1}$	Latch				13	1 1 1 1	@ @ @ @		B4	G D ₀ D ₃	+Q ₀ +Q ₃	1.8 1.5	1.2	1.8 1.5	0.9									
G	+Q ₀	+Q ₁	+Q ₂	+Q ₃																																
1	D ₀	D ₁	D ₂	D ₃																																
$\bar{1}$	Latch																																			
4-Bit D latch with CLR LD4C1	<table border="1"> <tr> <th>G</th> <th>CL</th> <th>+Q₀</th> <th>+Q₁</th> <th>+Q₂</th> <th>+Q₃</th> </tr> <tr> <td>1</td> <td>0</td> <td>D₀</td> <td>D₁</td> <td>D₂</td> <td>D₃</td> </tr> <tr> <td>$\bar{1}$</td> <td>0</td> <td colspan="4">Latch</td> </tr> <tr> <td>X</td> <td>1</td> <td>0</td> <td>0</td> <td>0</td> <td>0</td> </tr> </table> <p>X: Don't care</p>	G	CL	+Q ₀	+Q ₁	+Q ₂	+Q ₃	1	0	D ₀	D ₁	D ₂	D ₃	$\bar{1}$	0	Latch				X	1	0	0	0	0	14	1 1 1 1	@ @ @ @ #		B4	G D ₀ D ₃ CL	+Q ₀ +Q ₃	1.9 1.6 1.3	1.2	1.8 1.5 1.3	0.9
G	CL	+Q ₀	+Q ₁	+Q ₂	+Q ₃																															
1	0	D ₀	D ₁	D ₂	D ₃																															
$\bar{1}$	0	Latch																																		
X	1	0	0	0	0																															

12. FLIP-FLOPS (Normal Type)

Macrocell		Equivalent Gate Count	Normalized Load Factor	Clamp Level When Open	Symbol	Symbol No.	Delay																					
Function	Truth table						Input Name	Output Name	$t_{PLH}(ns)$		$t_{PHL}(ns)$																	
Function Name									t_{OLH}	k_{LH}	t_{OHL}	k_{HL}																
DFF FD	<table border="1"> <tr> <th>CK</th> <th>+Q</th> <th>-Q</th> </tr> <tr> <td>$\bar{1}$</td> <td>D</td> <td>\bar{D}</td> </tr> <tr> <td>$\bar{1}$</td> <td>+Q₀</td> <td>-Q₀</td> </tr> </table>	CK	+Q	-Q	$\bar{1}$	D	\bar{D}	$\bar{1}$	+Q ₀	-Q ₀	6	1	@ @		C	CK	+Q -Q	2.2 2.5	1.2	2.4 2.5	0.9							
CK	+Q	-Q																										
$\bar{1}$	D	\bar{D}																										
$\bar{1}$	+Q ₀	-Q ₀																										
DFF with Load FDL1	<table border="1"> <tr> <th>CK</th> <th>L</th> <th>+Q</th> <th>-Q</th> </tr> <tr> <td>$\bar{1}$</td> <td>0</td> <td>D_C</td> <td>\bar{D}_C</td> </tr> <tr> <td>$\bar{1}$</td> <td>1</td> <td>D_L</td> <td>\bar{D}_L</td> </tr> <tr> <td>$\bar{1}$</td> <td>X</td> <td>+Q₀</td> <td>-Q₀</td> </tr> </table> <p>X: Don't care</p>	CK	L	+Q	-Q	$\bar{1}$	0	D _C	\bar{D}_C	$\bar{1}$	1	D _L	\bar{D}_L	$\bar{1}$	X	+Q ₀	-Q ₀	8	1 1 1.2	@ @ #		C	CK	+Q -Q	2.2 2.5	1.2	2.4 2.5	0.9
CK	L	+Q	-Q																									
$\bar{1}$	0	D _C	\bar{D}_C																									
$\bar{1}$	1	D _L	\bar{D}_L																									
$\bar{1}$	X	+Q ₀	-Q ₀																									
DFF with CLR FDC1	<table border="1"> <tr> <th>CK</th> <th>CL</th> <th>+Q</th> <th>-Q</th> </tr> <tr> <td>$\bar{1}$</td> <td>0</td> <td>D</td> <td>\bar{D}</td> </tr> <tr> <td>$\bar{1}$</td> <td>0</td> <td>+Q₀</td> <td>-Q₀</td> </tr> <tr> <td>X</td> <td>1</td> <td>0</td> <td>1</td> </tr> </table> <p>X: Don't care</p>	CK	CL	+Q	-Q	$\bar{1}$	0	D	\bar{D}	$\bar{1}$	0	+Q ₀	-Q ₀	X	1	0	1	7	1 1.2	@ @ #		C	CK CL CK CL	+Q -Q	2.2 — 2.9 0.9	1.2	2.4 2.5 2.6 —	0.9
CK	CL	+Q	-Q																									
$\bar{1}$	0	D	\bar{D}																									
$\bar{1}$	0	+Q ₀	-Q ₀																									
X	1	0	1																									

Macrocell		Equiva- lent Gate Count	Normal- ized Load Factor	Clamp Level When Open	Symbol	Symbol No.	Delay																																																																				
Function	Truth table						Input Name	Output Name	$t_{PLH}(ns)$		$t_{PHL}(ns)$																																																																
Function Name									t_{OLH}	K_{LH}	t_{OHL}	K_{HL}																																																															
DFF with PRE FDP1	<table border="1"> <tr><th>CK</th><th>PR</th><th>+Q</th><th>-Q</th></tr> <tr><td>f</td><td>0</td><td>D</td><td>\bar{D}</td></tr> <tr><td>\bar{f}</td><td>0</td><td>+Q₀</td><td>-Q₀</td></tr> <tr><td>X</td><td>1</td><td>1</td><td>0</td></tr> </table> <p>X:Don't care</p>	CK	PR	+Q	-Q	f	0	D	\bar{D}	\bar{f}	0	+Q ₀	-Q ₀	X	1	1	0	7	1 1 1.2	@ @ #		C	CK	+Q	2.6	1.2	2.8	0.9																																															
CK	PR	+Q	-Q																																																																								
f	0	D	\bar{D}																																																																								
\bar{f}	0	+Q ₀	-Q ₀																																																																								
X	1	1	0																																																																								
							PR	-Q	1.0	-	-																																																																
							CK	-Q	2.8	1.2	3.0	0.9																																																															
							PR	-Q	-	-	1.4																																																																
DFF with PRE/ CLR FDPC3	<table border="1"> <tr><th>CK</th><th>PR</th><th>CL</th><th>+Q</th><th>-Q</th></tr> <tr><td>f</td><td>0</td><td>0</td><td>D</td><td>\bar{D}</td></tr> <tr><td>\bar{f}</td><td>0</td><td>0</td><td>+Q₀</td><td>-Q₀</td></tr> <tr><td>X</td><td>1</td><td>0</td><td>1</td><td>0</td></tr> <tr><td>X</td><td>0</td><td>1</td><td>0</td><td>1</td></tr> <tr><td>X</td><td>1</td><td>1</td><td>1</td><td>1</td></tr> </table> <p>X:Don't care</p>	CK	PR	CL	+Q	-Q	f	0	0	D	\bar{D}	\bar{f}	0	0	+Q ₀	-Q ₀	X	1	0	1	0	X	0	1	0	1	X	1	1	1	1	8	1 1 1.2 1.2	@ @ # #		C	CK	+Q	2.6	-	2.8	0.9																																	
CK	PR	CL	+Q	-Q																																																																							
f	0	0	D	\bar{D}																																																																							
\bar{f}	0	0	+Q ₀	-Q ₀																																																																							
X	1	0	1	0																																																																							
X	0	1	0	1																																																																							
X	1	1	1	1																																																																							
							CL	+Q	-	1.2	2.9																																																																
							PR	-Q	1.0	-	1.2																																																																
							CK	-Q	3.2	-	3.1	0.9																																																															
							CL	-Q	0.9	1.2	0.6																																																																
							PR	-Q	-	-	1.5																																																																
JKFF FJ	<table border="1"> <tr><th>CK</th><th>J</th><th>K</th><th>+Q</th><th>-Q</th></tr> <tr><td>f</td><td>0</td><td>0</td><td>0</td><td>1</td></tr> <tr><td>\bar{f}</td><td>1</td><td>1</td><td>1</td><td>0</td></tr> <tr><td>\bar{f}</td><td>0</td><td>1</td><td>+Q₀</td><td>-Q₀</td></tr> <tr><td>\bar{f}</td><td>1</td><td>0</td><td>-Q₀</td><td>+Q₀</td></tr> <tr><td>\bar{f}</td><td>X</td><td>X</td><td>+Q₀</td><td>-Q₀</td></tr> </table> <p>X:Don't care</p>	CK	J	K	+Q	-Q	f	0	0	0	1	\bar{f}	1	1	1	0	\bar{f}	0	1	+Q ₀	-Q ₀	\bar{f}	1	0	-Q ₀	+Q ₀	\bar{f}	X	X	+Q ₀	-Q ₀	9	1.2 1 1	@ @ #		C	CK	+Q	2.7	1.2	2.1	0.9																																	
CK	J	K	+Q	-Q																																																																							
f	0	0	0	1																																																																							
\bar{f}	1	1	1	0																																																																							
\bar{f}	0	1	+Q ₀	-Q ₀																																																																							
\bar{f}	1	0	-Q ₀	+Q ₀																																																																							
\bar{f}	X	X	+Q ₀	-Q ₀																																																																							
							CK	-Q	2.7	1.2	2.2	0.9																																																															
JKFF with CLR FJC1	<table border="1"> <tr><th>CK</th><th>J</th><th>K</th><th>CL</th><th>+Q</th><th>-Q</th></tr> <tr><td>f</td><td>0</td><td>0</td><td>0</td><td>0</td><td>1</td></tr> <tr><td>\bar{f}</td><td>1</td><td>1</td><td>0</td><td>1</td><td>0</td></tr> <tr><td>\bar{f}</td><td>0</td><td>1</td><td>0</td><td>+Q₀</td><td>-Q₀</td></tr> <tr><td>\bar{f}</td><td>1</td><td>0</td><td>0</td><td>-Q₀</td><td>+Q₀</td></tr> <tr><td>\bar{f}</td><td>X</td><td>X</td><td>0</td><td>+Q₀</td><td>-Q₀</td></tr> <tr><td>X</td><td>X</td><td>X</td><td>1</td><td>0</td><td>1</td></tr> </table> <p>X:Don't care</p>	CK	J	K	CL	+Q	-Q	f	0	0	0	0	1	\bar{f}	1	1	0	1	0	\bar{f}	0	1	0	+Q ₀	-Q ₀	\bar{f}	1	0	0	-Q ₀	+Q ₀	\bar{f}	X	X	0	+Q ₀	-Q ₀	X	X	X	1	0	1	12	1.2 1 1 1	@ @ # #		C	CK	+Q	3.2	1.2	2.6	0.9																					
CK	J	K	CL	+Q	-Q																																																																						
f	0	0	0	0	1																																																																						
\bar{f}	1	1	0	1	0																																																																						
\bar{f}	0	1	0	+Q ₀	-Q ₀																																																																						
\bar{f}	1	0	0	-Q ₀	+Q ₀																																																																						
\bar{f}	X	X	0	+Q ₀	-Q ₀																																																																						
X	X	X	1	0	1																																																																						
							CL	+Q	-	-	2.1																																																																
							CK	-Q	2.8	1.2	2.8	0.9																																																															
							CL	-Q	3.0	-	-																																																																
JKFF with PRE/ CLR FJPC1	<table border="1"> <tr><th>CK</th><th>J</th><th>K</th><th>PR</th><th>CL</th><th>+Q</th><th>-Q</th></tr> <tr><td>f</td><td>0</td><td>0</td><td>1</td><td>0</td><td>0</td><td>1</td></tr> <tr><td>\bar{f}</td><td>1</td><td>1</td><td>1</td><td>0</td><td>1</td><td>0</td></tr> <tr><td>\bar{f}</td><td>0</td><td>1</td><td>1</td><td>0</td><td>+Q₀</td><td>-Q₀</td></tr> <tr><td>\bar{f}</td><td>1</td><td>0</td><td>1</td><td>0</td><td>-Q₀</td><td>+Q₀</td></tr> <tr><td>\bar{f}</td><td>X</td><td>X</td><td>1</td><td>0</td><td>+Q₀</td><td>-Q₀</td></tr> <tr><td>X</td><td>X</td><td>X</td><td>0</td><td>0</td><td>1</td><td>0</td></tr> <tr><td>X</td><td>X</td><td>X</td><td>1</td><td>1</td><td>0</td><td>1</td></tr> <tr><td>X</td><td>X</td><td>X</td><td>0</td><td>1</td><td>0</td><td>0</td></tr> </table> <p>X:Don't care</p>	CK	J	K	PR	CL	+Q	-Q	f	0	0	1	0	0	1	\bar{f}	1	1	1	0	1	0	\bar{f}	0	1	1	0	+Q ₀	-Q ₀	\bar{f}	1	0	1	0	-Q ₀	+Q ₀	\bar{f}	X	X	1	0	+Q ₀	-Q ₀	X	X	X	0	0	1	0	X	X	X	1	1	0	1	X	X	X	0	1	0	0	13	1.2 1 1 1.2 1	@ @ # @ #		C	CK	+Q	3.2	-	2.6	0.9
CK	J	K	PR	CL	+Q	-Q																																																																					
f	0	0	1	0	0	1																																																																					
\bar{f}	1	1	1	0	1	0																																																																					
\bar{f}	0	1	1	0	+Q ₀	-Q ₀																																																																					
\bar{f}	1	0	1	0	-Q ₀	+Q ₀																																																																					
\bar{f}	X	X	1	0	+Q ₀	-Q ₀																																																																					
X	X	X	0	0	1	0																																																																					
X	X	X	1	1	0	1																																																																					
X	X	X	0	1	0	0																																																																					
							$\bar{P}R$	+Q	2.9	1.2	-																																																																
							CL	+Q	0.9	-	2.1																																																																
							CK	-Q	2.9	-	2.8	0.9																																																															
							$\bar{P}R$	-Q	0.9	1.2	1.1																																																																
							CL	-Q	3.1	-	-																																																																
TFF with CLR FTC1	<table border="1"> <tr><th>CK</th><th>CL</th><th>+Q</th><th>-Q</th></tr> <tr><td>f</td><td>0</td><td>-Q₀</td><td>+Q₀</td></tr> <tr><td>\bar{f}</td><td>0</td><td>+Q₀</td><td>-Q₀</td></tr> <tr><td>X</td><td>1</td><td>0</td><td>1</td></tr> </table> <p>X:Don't care</p>	CK	CL	+Q	-Q	f	0	-Q ₀	+Q ₀	\bar{f}	0	+Q ₀	-Q ₀	X	1	0	1	8	1 1.2	@ #		C	CK	+Q	2.2	1.2	2.4	0.9																																															
CK	CL	+Q	-Q																																																																								
f	0	-Q ₀	+Q ₀																																																																								
\bar{f}	0	+Q ₀	-Q ₀																																																																								
X	1	0	1																																																																								
							CL	+Q	-	-	2.5																																																																
							CK	-Q	2.9	1.2	2.6	0.9																																																															
							CL	-Q	0.9	-	-																																																																

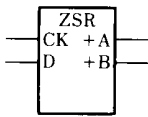
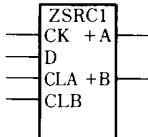
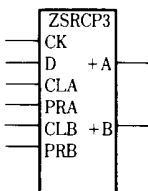
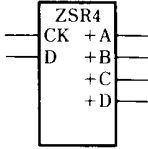
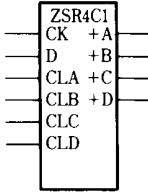

Macrocell		Equivalent Gate Count	Normalized Load Factor	Clamp Level When Open	Symbol	Symbol No.	Delay																																			
Function	Truth table						Input Name	Output Name	$t_{PLH}(ns)$		$t_{PHL}(ns)$																															
Function Name									t_{OLH}	K_{LH}	t_{OHL}	K_{HL}																														
TFF with PRE	<table border="1"> <tr><th>CK</th><th>PR</th><th>+Q</th><th>-Q</th></tr> <tr><td>f</td><td>0</td><td>-Q₀</td><td>+Q₀</td></tr> <tr><td>l</td><td>0</td><td>+Q₀</td><td>-Q₀</td></tr> <tr><td>X</td><td>1</td><td>1</td><td>0</td></tr> </table> <p>X: Don't care</p>	CK	PR	+Q	-Q	f	0	-Q ₀	+Q ₀	l	0	+Q ₀	-Q ₀	X	1	1	0	8	1	@		C	CK	+Q	2.6	1.2	2.8	0.9														
CK		PR	+Q	-Q																																						
f	0	-Q ₀	+Q ₀																																							
l	0	+Q ₀	-Q ₀																																							
X	1	1	0																																							
FTP1	PR	1.0	—																																							
	CK	-Q	2.8	1.2	3.0	0.9																																				
	PR	—	—		1.4																																					
TFF with PRE/CLR	<table border="1"> <tr><th>CK</th><th>PR</th><th>CL</th><th>+Q</th><th>-Q</th></tr> <tr><td>f</td><td>0</td><td>0</td><td>-Q₀</td><td>+Q₀</td></tr> <tr><td>l</td><td>0</td><td>0</td><td>+Q₀</td><td>-Q₀</td></tr> <tr><td>X</td><td>1</td><td>0</td><td>1</td><td>0</td></tr> <tr><td>X</td><td>0</td><td>1</td><td>0</td><td>1</td></tr> <tr><td>X</td><td>1</td><td>1</td><td>1</td><td>1</td></tr> </table> <p>X: Don't care</p>	CK	PR	CL	+Q	-Q	f	0	0	-Q ₀	+Q ₀	l	0	0	+Q ₀	-Q ₀	X	1	0	1	0	X	0	1	0	1	X	1	1	1	1	9	1	@		C	CK	+Q	2.6	1.2	2.8	0.9
CK		PR	CL	+Q	-Q																																					
f	0	0	-Q ₀	+Q ₀																																						
l	0	0	+Q ₀	-Q ₀																																						
X	1	0	1	0																																						
X	0	1	0	1																																						
X	1	1	1	1																																						
	PR	1.0	—	1.2																																						
	CL	—	—	2.9																																						
	CK	-Q	3.2	1.2	3.1	0.9																																				
	PR	—	—		1.5																																					
	CL	0.9	—	0.6																																						
4-Bit DFF	<table border="1"> <tr><th>CK</th><th>+Q₀</th><th>+Q₁</th><th>+Q₂</th><th>+Q₃</th></tr> <tr><td>f</td><td>D₀</td><td>D₁</td><td>D₂</td><td>D₃</td></tr> <tr><td>l</td><td>+Q₀₀</td><td>+Q₁₀</td><td>+Q₂₀</td><td>+Q₃₀</td></tr> </table>	CK	+Q ₀	+Q ₁	+Q ₂	+Q ₃	f	D ₀	D ₁	D ₂	D ₃	l	+Q ₀₀	+Q ₁₀	+Q ₂₀	+Q ₃₀	21	1	@		B4	CK	+Q ₀ ? +Q ₃	2.4	1.2	2.6	0.9															
CK		+Q ₀	+Q ₁	+Q ₂	+Q ₃																																					
f	D ₀	D ₁	D ₂	D ₃																																						
l	+Q ₀₀	+Q ₁₀	+Q ₂₀	+Q ₃₀																																						
FD4																																										
4-Bit DFF with CLR	<table border="1"> <tr><th>CK</th><th>CL</th><th>+Q₀</th><th>+Q₁</th><th>+Q₂</th><th>+Q₃</th></tr> <tr><td>f</td><td>0</td><td>D₀</td><td>D₁</td><td>D₂</td><td>D₃</td></tr> <tr><td>l</td><td>0</td><td>+Q₀₀</td><td>+Q₁₀</td><td>+Q₂₀</td><td>+Q₃₀</td></tr> <tr><td>X</td><td>1</td><td>0</td><td>0</td><td>0</td><td>0</td></tr> </table> <p>X: Don't care</p>	CK	CL	+Q ₀	+Q ₁	+Q ₂	+Q ₃	f	0	D ₀	D ₁	D ₂	D ₃	l	0	+Q ₀₀	+Q ₁₀	+Q ₂₀	+Q ₃₀	X	1	0	0	0	0	25	1	@		B4	CK	+Q ₀ ? +Q ₃	2.6	1.2	2.6	0.9						
CK		CL	+Q ₀	+Q ₁	+Q ₂	+Q ₃																																				
f	0	D ₀	D ₁	D ₂	D ₃																																					
l	0	+Q ₀₀	+Q ₁₀	+Q ₂₀	+Q ₃₀																																					
X	1	0	0	0	0																																					
FD4C1	CL	—	—	1.6																																						

13. SHIFT REGISTERS (Normal Type)

Macrocell		Equivalent Gate Count	Normalized Load Factor	Clamp Level When Open	Symbol	Symbol No.	Delay																																																																				
Function	Truth table						Input Name	Output Name	t _{PLH} (ns)		t _{PHL} (ns)																																																																
Function Name									t _{OLH}	K _{LH}	t _{OHL}	K _{HL}																																																															
2-Bit SR	<table border="1"> <tr><td>CK</td><td>+A</td><td>+B</td></tr> <tr><td>f</td><td>D</td><td>+A₀</td></tr> <tr><td>l</td><td>+A₀</td><td>+B₀</td></tr> </table>	CK	+A	+B	f	D	+A ₀	l	+A ₀	+B ₀	10	1	@		B1	CK	+A	2.3	1.2	2.5	0.9																																																						
CK		+A	+B																																																																								
f	D	+A ₀																																																																									
l	+A ₀	+B ₀																																																																									
ZSR	+B	2.3	1.2	2.5	0.9																																																																						
2-Bit SR with CLR	<table border="1"> <tr><td>CK</td><td>CLA</td><td>CLB</td><td>+A</td><td>+B</td></tr> <tr><td>f</td><td>0</td><td>0</td><td>D</td><td>+A₀</td></tr> <tr><td>l</td><td>0</td><td>0</td><td>+A₀</td><td>+B₀</td></tr> <tr><td>x</td><td>1</td><td>x</td><td>0</td><td>x</td></tr> <tr><td>x</td><td>x</td><td>1</td><td>x</td><td>0</td></tr> </table> <p>X:Don't care</p>	CK	CLA	CLB	+A	+B	f	0	0	D	+A ₀	l	0	0	+A ₀	+B ₀	x	1	x	0	x	x	x	1	x	0	12	1	@		C	CK	+A	2.4	1.2	2.6	0.9																																						
CK		CLA	CLB	+A	+B																																																																						
f	0	0	D	+A ₀																																																																							
l	0	0	+A ₀	+B ₀																																																																							
x	1	x	0	x																																																																							
x	x	1	x	0																																																																							
ZSRC1	CLA	+B	2.4	1.2	2.6	0.9																																																																					
2-Bit SR with CLR/PRE	<table border="1"> <tr><td>CK</td><td>CLA</td><td>CLB</td><td>PRA</td><td>PRB</td><td>+A</td><td>+B</td></tr> <tr><td>f</td><td>0</td><td>0</td><td>0</td><td>0</td><td>D</td><td>+A₀</td></tr> <tr><td>l</td><td>0</td><td>0</td><td>0</td><td>0</td><td>+A₀</td><td>+B₀</td></tr> <tr><td>x</td><td>1</td><td>x</td><td>x</td><td>x</td><td>0</td><td>x</td></tr> <tr><td>x</td><td>x</td><td>1</td><td>x</td><td>x</td><td>x</td><td>0</td></tr> <tr><td>x</td><td>x</td><td>x</td><td>1</td><td>x</td><td>1</td><td>x</td></tr> <tr><td>x</td><td>x</td><td>x</td><td>x</td><td>1</td><td>x</td><td>1</td></tr> <tr><td>x</td><td>1</td><td>x</td><td>1</td><td>x</td><td>1</td><td>x</td></tr> <tr><td>x</td><td>x</td><td>1</td><td>x</td><td>1</td><td>x</td><td>1</td></tr> </table> <p>X:Don't care</p>	CK	CLA	CLB	PRA	PRB	+A	+B	f	0	0	0	0	D	+A ₀	l	0	0	0	0	+A ₀	+B ₀	x	1	x	x	x	0	x	x	x	1	x	x	x	0	x	x	x	1	x	1	x	x	x	x	x	1	x	1	x	1	x	1	x	1	x	x	x	1	x	1	x	1	14	1	@		B4	CK	+A	2.8	1.2	3.0	0.9
CK		CLA	CLB	PRA	PRB	+A	+B																																																																				
f	0	0	0	0	D	+A ₀																																																																					
l	0	0	0	0	+A ₀	+B ₀																																																																					
x	1	x	x	x	0	x																																																																					
x	x	1	x	x	x	0																																																																					
x	x	x	1	x	1	x																																																																					
x	x	x	x	1	x	1																																																																					
x	1	x	1	x	1	x																																																																					
x	x	1	x	1	x	1																																																																					
ZSRCP3	CLA	+B	2.8	1.2	3.0	0.9																																																																					
4-Bit SR	<table border="1"> <tr><td>CK</td><td>+A</td><td>+B</td><td>+C</td><td>+D</td></tr> <tr><td>f</td><td>D</td><td>+A₀</td><td>+B₀</td><td>+C₀</td></tr> <tr><td>l</td><td>+A₀</td><td>+B₀</td><td>+C₀</td><td>+D₀</td></tr> </table>	CK	+A	+B	+C	+D	f	D	+A ₀	+B ₀	+C ₀	l	+A ₀	+B ₀	+C ₀	+D ₀	19	1	@		C	CK	+A	2.4	1.2	2.6	0.9																																																
CK		+A	+B	+C	+D																																																																						
f	D	+A ₀	+B ₀	+C ₀																																																																							
l	+A ₀	+B ₀	+C ₀	+D ₀																																																																							
ZSR4	+B	2.4	1.2	2.6	0.9																																																																						
4-Bit SR with CLR	<table border="1"> <tr><td>CK</td><td>CLA</td><td>CLB</td><td>CLC</td><td>CLD</td><td>+A</td><td>+B</td><td>+C</td><td>+D</td></tr> <tr><td>f</td><td>0</td><td>0</td><td>0</td><td>0</td><td>D</td><td>+A₀</td><td>+B₀</td><td>+C₀</td></tr> <tr><td>l</td><td>0</td><td>0</td><td>0</td><td>0</td><td>+A₀</td><td>+B₀</td><td>+C₀</td><td>+D₀</td></tr> <tr><td>x</td><td>1</td><td>x</td><td>x</td><td>x</td><td>0</td><td>x</td><td>x</td><td>x</td></tr> <tr><td>x</td><td>x</td><td>1</td><td>x</td><td>x</td><td>x</td><td>0</td><td>x</td><td>x</td></tr> <tr><td>x</td><td>x</td><td>x</td><td>1</td><td>x</td><td>x</td><td>x</td><td>0</td><td>x</td></tr> <tr><td>x</td><td>x</td><td>x</td><td>x</td><td>1</td><td>x</td><td>x</td><td>x</td><td>0</td></tr> </table> <p>X:Don't care</p>	CK	CLA	CLB	CLC	CLD	+A	+B	+C	+D	f	0	0	0	0	D	+A ₀	+B ₀	+C ₀	l	0	0	0	0	+A ₀	+B ₀	+C ₀	+D ₀	x	1	x	x	x	0	x	x	x	x	x	1	x	x	x	0	x	x	x	x	x	1	x	x	x	0	x	x	x	x	x	1	x	x	x	0	23	1	@		B4	CK	+A	2.6	1.2	2.8	0.9
CK		CLA	CLB	CLC	CLD	+A	+B	+C	+D																																																																		
f	0	0	0	0	D	+A ₀	+B ₀	+C ₀																																																																			
l	0	0	0	0	+A ₀	+B ₀	+C ₀	+D ₀																																																																			
x	1	x	x	x	0	x	x	x																																																																			
x	x	1	x	x	x	0	x	x																																																																			
x	x	x	1	x	x	x	0	x																																																																			
x	x	x	x	1	x	x	x	0																																																																			
ZSR4C1	CLA	+B	2.6	1.2	2.8	0.9																																																																					

14. OTHERS

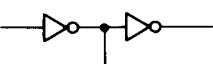
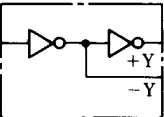
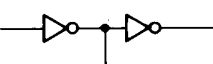
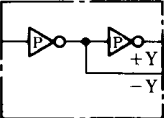
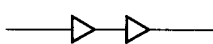
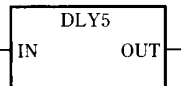
Macrocell		Equivalent Gate Count	Normalized Load Factor	Clamp Level When Open	Symbol	Symbol No.	Delay					
Function	Equivalent circuit						Input Name	Output Name	t _{PLH} (ns)		t _{PHL} (ns)	
Function Name									t _{OLH}	K _{LLH}	t _{OHL}	K _{HLL}
4-Bit comparator		12	1.2	# # # # # # # #		B5	A ₀ A ₁ A ₂ A ₃ B ₀ B ₁ B ₂ B ₃		1.4	3.7	1.6	0.9
1-Bit full-adder		7	1.2 1.2 1.2	# # #		B2	A, B +Co Ci A, B +S Ci		1.8 0.9 1.6 0.9	1.2 1.2	1.5 0.8 2.2 1.3	1.2 0.9
2-Bit full-adder		14	1.2 1.2 1.2 1.2	# # # #		C	An, Bn +Co Ci An, Bn +Sn Ci		2.7 1.8 2.7 1.8	1.2 1.2	2.6 1.6 3.0 2.1	1.2 0.9
4-Bit full-adder		43	1.2 1.2 1.2 1.2 1.2 1.2 1.2 1.6	# # # # # # # #		B5	An, Bn +Co Ci An, Bn +Sn Ci		2.2 2.0 4.3 3.6	1.2 2.0	1.9 1.7 4.4 3.7	0.9 0.9
9-Bit parity generator/checker		37	1 1 1 1 1 1 1 1	# # # # # # # #		B5	A Ev OD I		4.2 3.2	3.7 1.2	3.0 4.5	1.3 0.9

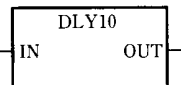
Macrocell		Equiva- lent Gate Count	Normal- ized Load Factor	Clamp Level When Open	Symbol	Symbol No.	Delay					
Function	Equivalent circuit						Input Name	Output Name	t _{PLH} (ns)		t _{PHL} (ns)	
Function Name									t _{OLH}	K _{LH}	t _{OHL}	K _{HL}
Buffer		1	1	@		A1	+Y	0.6	1.2	0.6	0.9	
BUF							-Y	0.3	1.2	0.4	0.9	
Power buffer		2	1.2	@		A1	+Y	0.7	0.6	0.7	0.5	
BUFP							-Y	0.4	0.6	0.4	0.5	
Delay cell		6	1	@			IN	OUT	5.0	1.2	5.2	0.9
DLY5												
Delay cell		13	1	@			IN	OUT	9.6	1.2	9.8	0.9
DLY10												

15. TTL 74 SERIES

Macro Function Name	Function	Gate count	
			with scan-function
HS00	QUADRUPLE 2-INPUT POSITIVE NAND GATES	4	
HS02	QUADRUPLE 2-INPUT POSITIVE NOR GATES	4	
HS04	HEX INVERTERS	6	
HS08	QUADRUPLE 2-INPUT POSITIVE AND GATES	8	
HS10	TRIPLE 3-INPUT POSITIVE NAND GATES	6	
HS11	TRIPLE 3-INPUT POSITIVE AND GATES	9	
HS20	DUAL 4-INPUT POSITIVE NAND GATES	4	
HS21	DUAL 4-INPUT POSITIVE AND GATES	6	
HS27	TRIPLE 3-INPUT POSITIVE NOR GATES	6	
HS30	8-INPUT POSITIVE NAND GATES	6	
HS32	QUADRUPLE 2-INPUT POSITIVE OR GATES	8	
HS42	BCD-TO-DECIMAL DECODER	28	
HS43	EXCESS 3-TO-DECIMAL DECODER	28	
HS44	EXCESS 3-GRAY-TO-DECIMAL DECODER	28	
HS51	2-WIDE 2-INPUT, 2-WIDE 3-INPUT AND-OR-INVERT GATES	6	
HS54	4-WIDE 2-INPUT, 3-INPUT AND-OR-INVERT GATE	9	
HS55	2-WIDE 4-INPUT AND-OR-INVERT GATE	5	
HS73	DUAL J-K NEGATIVE EDGE-TRIGGERED FLIP FLOPS (WITH CLEAR)	32	34
HS74	D-TYPE POSITIVE EDGE-TRIGGERED FLIP FLOPS	20	22
HS75	QUADRUPLE LATCHES	16	20
HS76	DUAL J-K NEGATIVE EDGE-TRIGGERED FLIP FLOPS (WITH PRESET AND CLEAR)	32	34
HS77	4-BIT BISTABLE LATCHES	16	20
HS78	DUAL J-K NEGATIVE EDGE-TRIGGERED FLIP FLOPS (WITH PRESET, COMMON CLEAR, AND COMMON CLOCK)	30	32
HS82	2-BIT BINARY FULL ADDER	29	
HS83	4-BIT BINARY FULL ADDER	63	
HS85	4-BIT MAGNITUDE COMPARATOR	78	
HS86	QUADRUPLE EXCLUSIVE-OR GATES	12	
HS90	DECADE COUNTER	41	45
HS91	8-BIT SHIFT REGISTER	50	58
HS92	DIVIDE-BY-TWELVE COUNTER	34	38
HS93	4-BIT BINARY COUNTER	32	36
HS94	4-BIT SHIFT REGISTER	44	48
HS95	4-BIT SHIFT REGISTER	40	44

Macro Function Name	Function	Gate count	
			with scan-function
HS96	5-BIT SHIFT REGISTER (DUAL PARALLEL-IN, PARALLEL-OUT)	51	56
HS97	SYNCHRONOUS 6-BIT BINARY RATE MULTIPLEXER	144	150
HS98	4-BIT DATA SELECTOR/STORAGE REGISTER	35	39
HS99	4-BIT RIGHT-SHIFT LEFT-SHIFT REGISTER	46	49
HS109	DUAL J-K POSITIVE EDGE-TRIGGERED FLIP FLOPS (WITH PRESET AND CLEAR)	28	30
HS113	DUAL J-K NEGATIVE EDGE-TRIGGERED FLIP FLOPS (WITH PRESET)	30	32
HS135	QUADRUPLE EXCLUSIVE-OR/NOR GATES	24	
HS137	3-LINE-TO-8-LINE DECODER/DEMUTIPLEXER WITH ADDRESS LATCHES	36	51
HS138	3-TO-8-LINE DECODER/DEMUTIPLEXER	25	
HS139	DUAL 2-TO-4-LINE DECODERS/DEMUTIPLEXERS	26	
HS147	10-LINE-TO-4-LINE PRIORITY ENCODER	46	
HS148	8-LINE-TO-3-LINE PRIORITY ENCODER	49	
HS150	16-BIT DATA SELECTOR/MULTIPLEXER	101	
HS151	1-OF-8-LINE DATA SELECTOR/MULTIPLEXER (WITH STROBE)	54	
HS152	1-OF-8-LINE DATA SELECTOR/MULTIPLEXER	29	
HS153	DUAL 4-OF-1-LINE DATA SELECTORS/MULTIPLEXERS	26	
HS154	4-OF-16-LINE DECODER/DEMUTIPLEXER	89	
HS155	DUAL 2-OF-4-LINE DECODERS/DEMUTIPLEXERS	23	
HS157	QUADRUPLE 2-OF-1-LINE DATA SELECTORS/MULTIPLEXERS (WITH NONINVERTED DATA OUTPUTS)	15	
HS158	QUADRUPLE 2-OF-1-LINE DATA SELECTORS/MULTIPLEXERS (WITH INVERTED DATA OUTPUTS)	11	
HS160	SYNCHRONOUS DECADE COUNTER	76	80
HS161	SYNCHRONOUS 4-BIT BINARY COUNTER	80	84
HS162	FULLY SYNCHRONOUS DECADE COUNTER	72	76
HS163	FULLY SYNCHRONOUS 4-BIT BINARY COUNTER	76	80
HS164	8-BIT PARALLEL-OUT SHIFT REGISTER	59	67
HS165	PARALLEL-LOAD 8-BIT SHIFT REGISTER	93	101
HS166	PARALLEL-LOAD 8-BIT SHIFT REGISTER	85	93
HS168	SYNCHRONOUS DECADE UP/DOWN COUNTER	94	98
HS169	SYNCHRONOUS BINARY UP/DOWN COUNTER	85	89
HS173	4-BIT D-TYPE REGISTER (WITH 3-STATE OUTPUTS)	51	55
HS174	HEX D-TYPE FLIP FLOPS (WITH CLEAR)	43	49
HS175	QUADRUPLE D-TYPE FLIP FLOPS (WITH CLEAR)	29	33
HS176	PRESETTABLE DECADE COUNTER	74	78

Macro Function Name	Function	Gate count	
			with scan-function
HS177	PRESETTABLE 4-BIT BINARY COUNTER	60	64
HS180	8-BIT ODD/EVEN PARITY GENERATOR/CHECKER	30	
HS181	ARITHMETIC LOGIC UNIT/FUNCTION GENERATOR	119	
HS182	LOOK-AHEAD CARRY GENERATOR	41	
HS183	DUAL CARRY SAVE FULL ADDERS	40	
HS190	SYNCHRONOUS UP/DOWN DECADE COUNTER (SINGLE CLOCK LINE)	105	109
HS191	SYNCHRONOUS UP/DOWN 4-BIT BINARY COUNTER (SINGLE CLOCK LINE)	101	105
HS192	SYNCHRONOUS UP/DOWN DECADE COUNTER (DUAL CLOCK LINE)	91	95
HS193	SYNCHRONOUS UP/DOWN 4-BIT BINARY COUNTER (DUAL CLOCK LINE)	87	91
HS194	4-BIT BIDIRECTIONAL UNIVERSAL SHIFT REGISTER	73	77
HS195	4-BIT PARALLEL ACCESS SHIFT REGISTER	47	51
HS198	8-BIT PARALLEL-IN, PARALLEL-OUT BIDIRECTIONAL SHIFT REGISTER	103	111
HS199	8-BIT PARALLEL-IN, PARALLEL-OUT SHIFT REGISTER (J-K INPUT FIRST STAGE)	89	97
HS251	1-OF-8-LINE DATA SELECTOR/MULTIPLEXER (WITH 3-STATE OUTPUTS)	34	
HS253	DUAL DATA SELECTORS/MULTIPLEXERS (WITH 3-STATE OUTPUTS)	32	
HS257	QUADRUPLE 2-TO-1-LINE DATA SELECTORS/MULTIPLEXERS (WITH NONINVERTED 3-STATE OUTPUTS)	19	
HS258	QUADRUPLE 2-TO-1-LINE DATA SELECTORS/MULTIPLEXERS (WITH 3-STATE OUTPUTS)	23	
HS259	8-BIT ADDRESSABLE LATCH	95	103
HS273	OCTAL D-TYPE POSITIVE-EDGE-TRIGGERED FLIP FLOPS (WITH CLEAR)	57	65
HS279	QUADRUPLE S-R LATCHES	18	38
HS280	9-BIT ODD/EVEN PARITY GENERATOR/CHECKER	62	
HS283	4-BIT BINARY FULL ADDER (WITH FAST CARRY)	66	
HS290	DECADE COUNTER	40	44
HS293	4-BIT BINARY COUNTER	32	36
HS298	QUADRUPLE 2-INPUT MULTIPLEXERS (WITH STORAGE)	35	39
HS299	8-BIT UNIVERSAL SHIFT/STORAGE REGISTER (WITH 3-STATE OUTPUTS)	160	168
HS373	OCTAL D-TYPE TRANSPARENT LATCHES (WITH 3-STATE OUTPUTS)	49	57
HS374	OCTAL D-TYPE EDGE-TRIGGERED FLOP FLOPS (WITH 3-STATE OUTPUTS)	65	73
HS390	DUAL DECADE COUNTERS	66	74
HS393	DUAL 4-BIT BINARY COUNTERS	58	66
HS490	DUAL 4-BIT DECADE COUNTERS	78	86
HS668	SYNCHRONOUS DECADE UP/DOWN COUNTER	95	99
HS669	SYNCHRONOUS 4-BIT BINARY UP/DOWN COUNTER	80	84

PACKAGE OUTLINE

Unit: mm (inch)

DILP-40

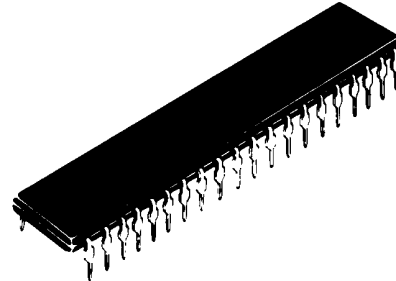
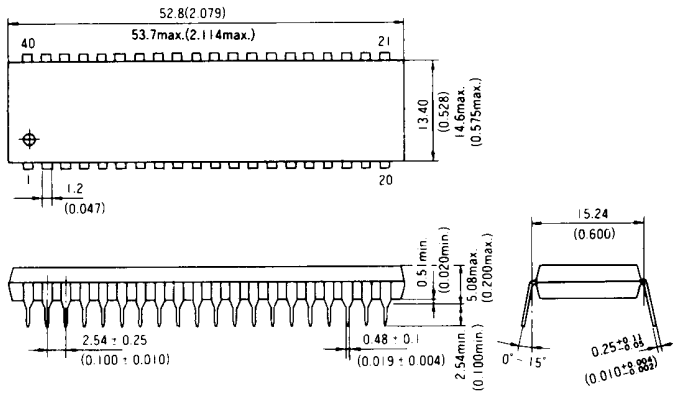

DILP-64S

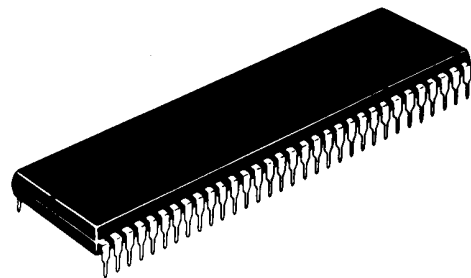
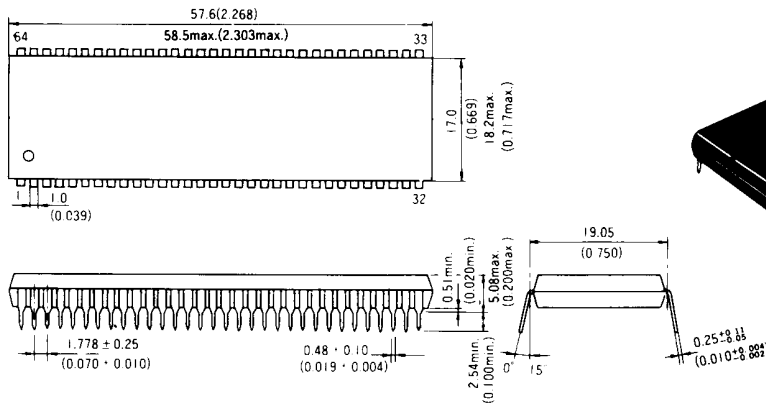

QFP-64

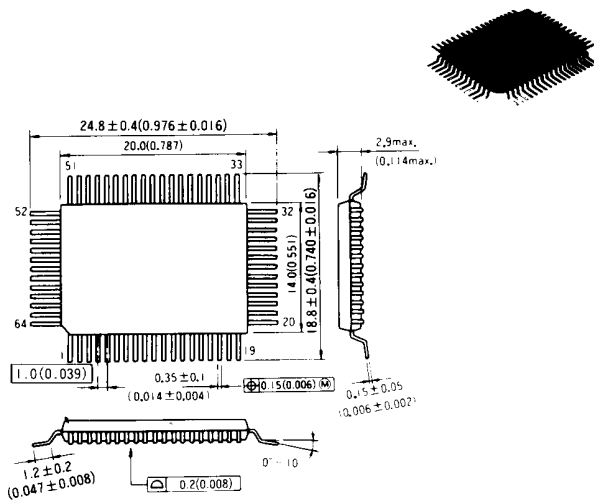

QFP-80

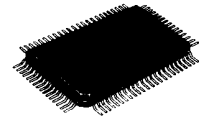
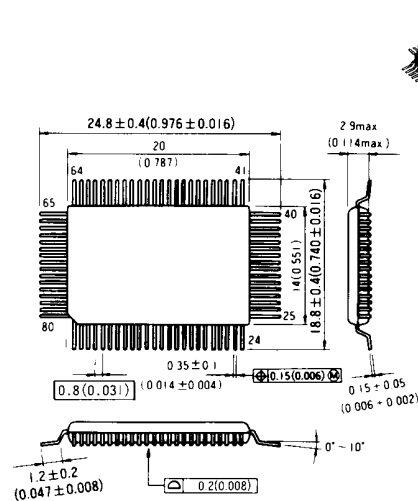

PACKAGE OUTLINE

Unit: mm (inch)

QFP-100

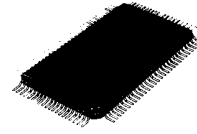
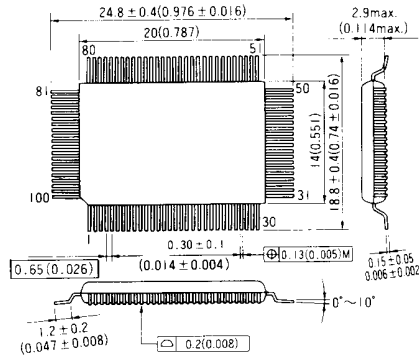

QFP5-136

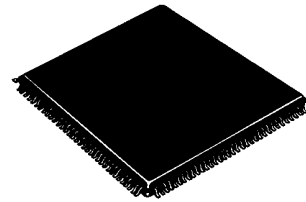
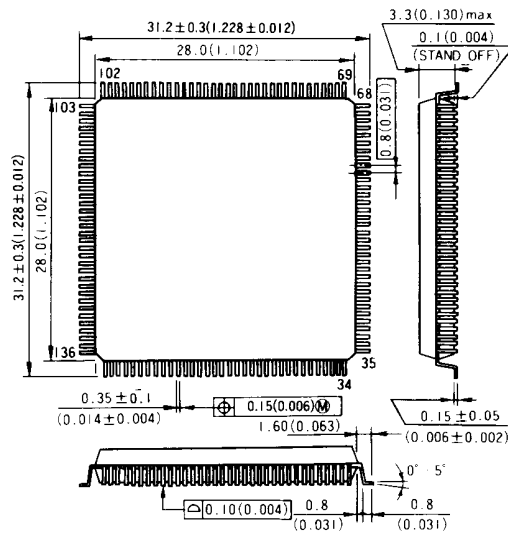

QFP5-168

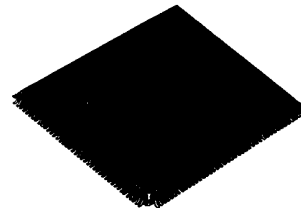
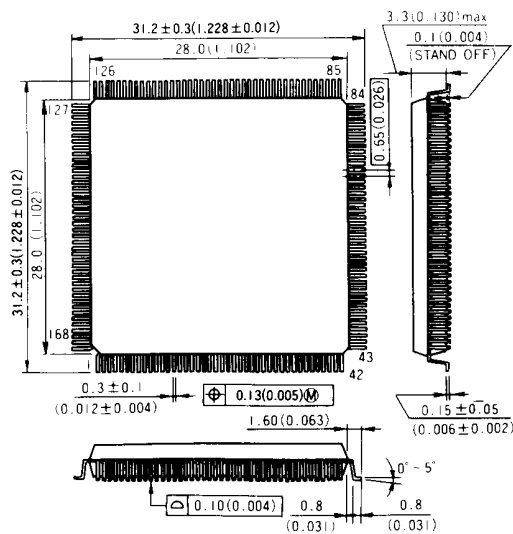

PACKAGE OUTLINE

Unit: mm (inch)

QFP5-208

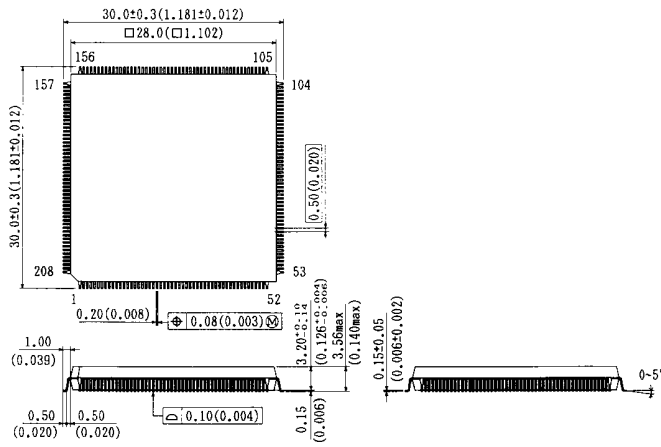

QFP3-64

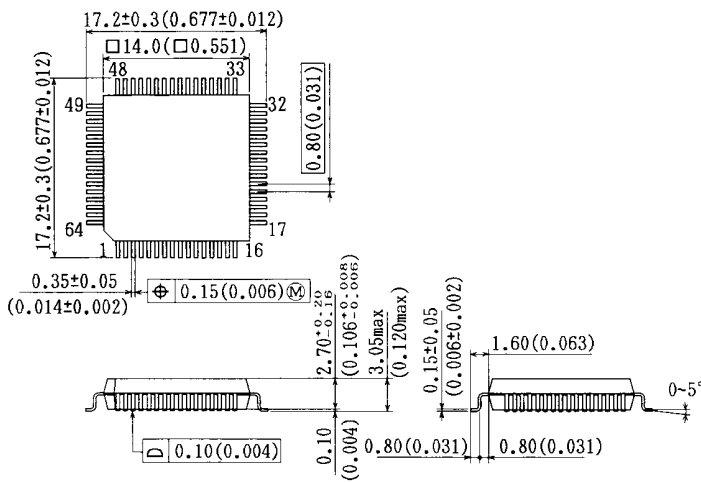

QFP3-80

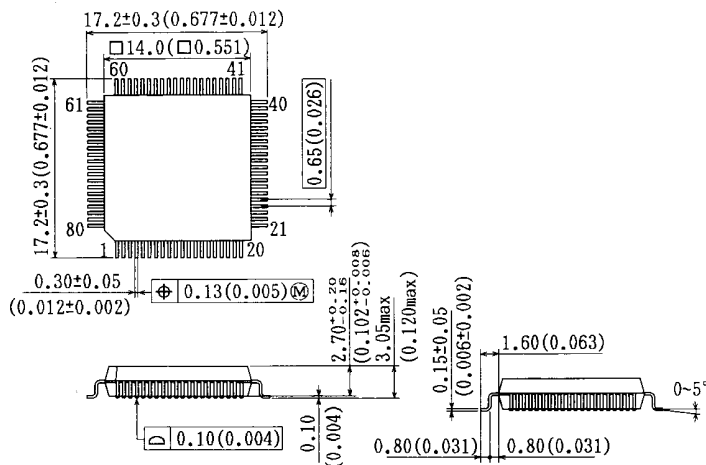

PACKAGE OUTLINE

Unit: mm (inch)

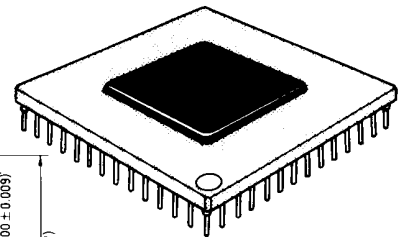
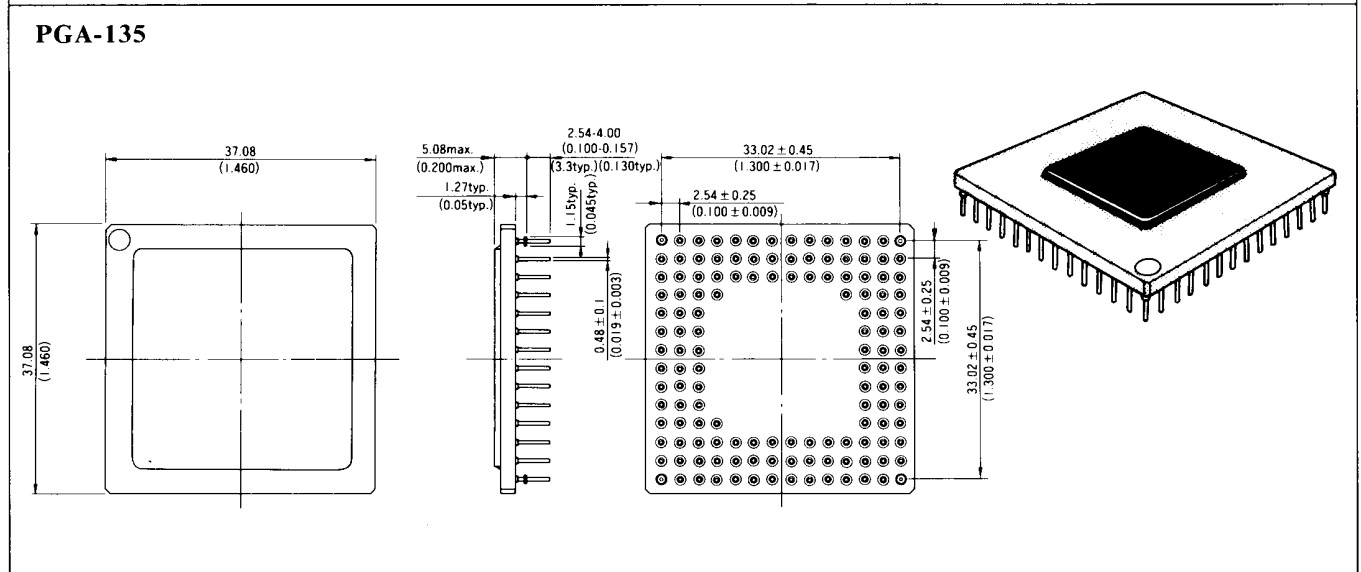
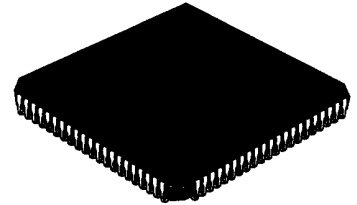
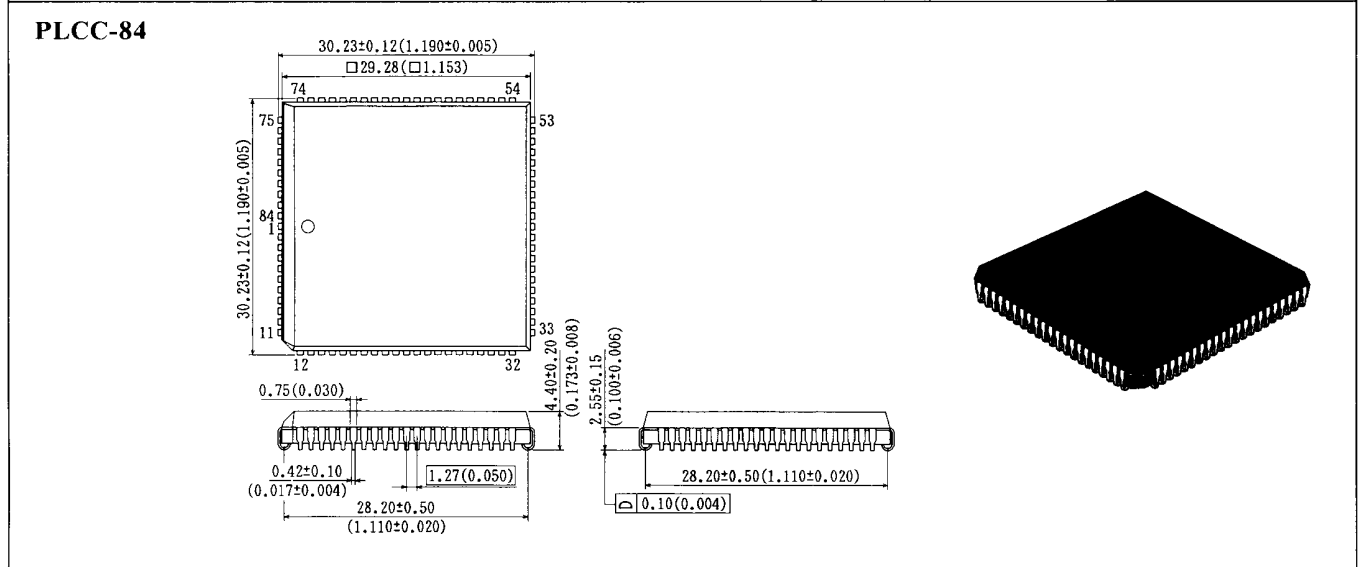
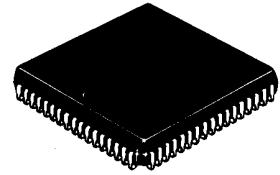
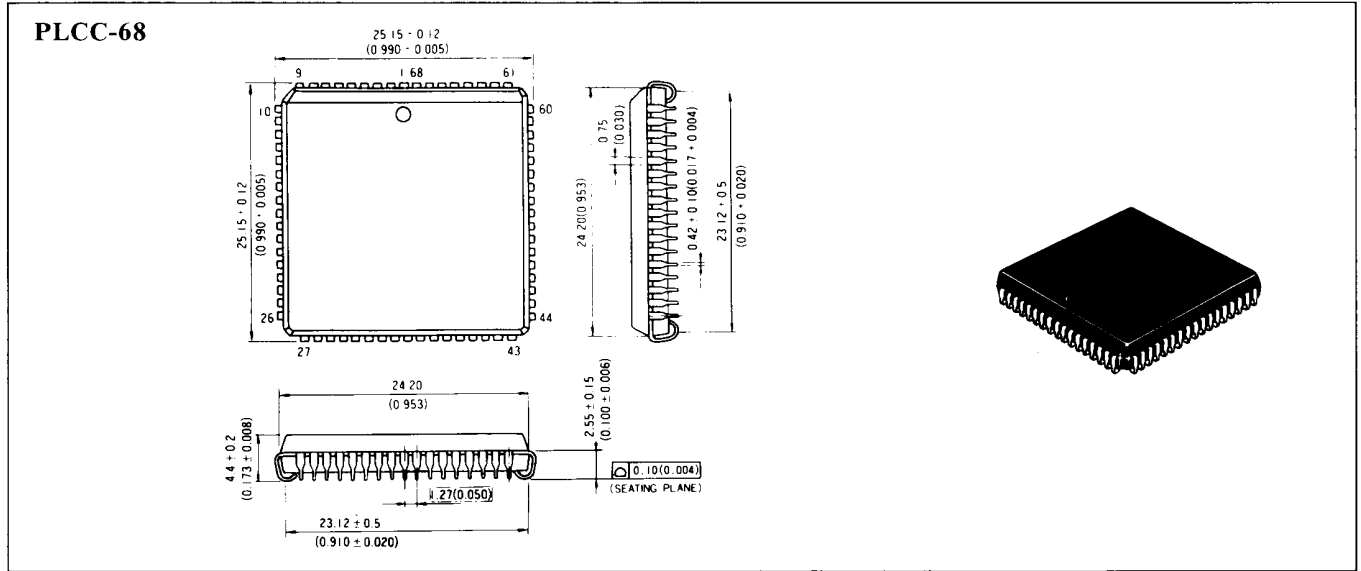

PACKAGE OUTLINE

Unit: mm (inch)

PGA-179

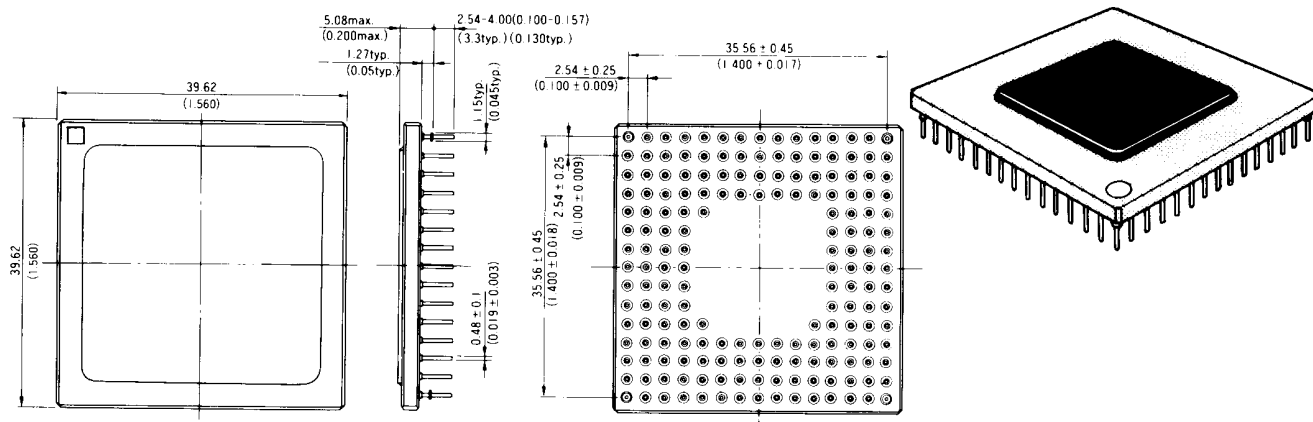

PGA-240

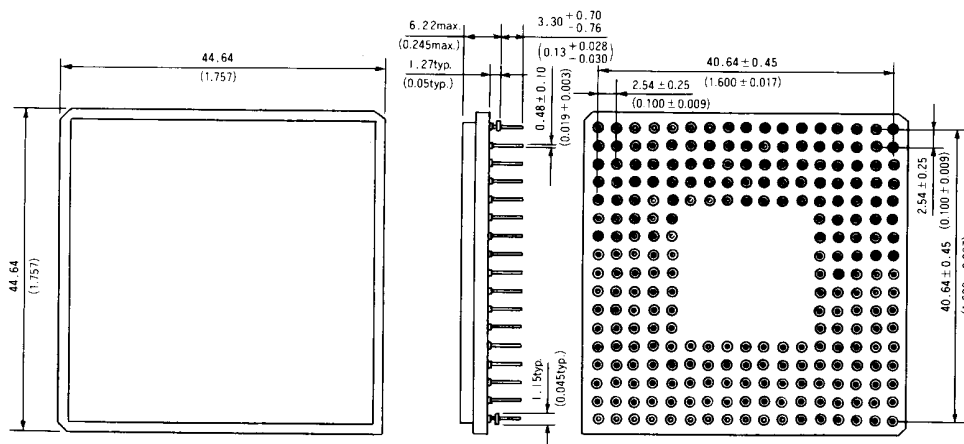

When using this document, keep the following in mind:

1. This document may, wholly or partially, be subject to change without notice.
2. All rights are reserved: No one is permitted to reproduce or duplicate, in any form, the whole or part of this document without Hitachi's permission.
3. Hitachi will not be held responsible for any damage to the user that may result from accidents or any other reasons during operation of the user's unit according to this document.
4. Circuitry and other examples described herein are meant merely to indicate the characteristics and performance of Hitachi's semiconductor products. Hitachi assumes no responsibility for any intellectual property claims or other problems that may result from applications based on the examples described herein.
5. No license is granted by implication or otherwise under any patents or other rights of any third party or Hitachi, Ltd.
6. **MEDICAL APPLICATIONS:** Hitachi's products are not authorized for use in MEDICAL APPLICATIONS without the written consent of the appropriate officer of Hitachi's sales company. Such use includes, but is not limited to, use in life support systems. Buyers of Hitachi's products are requested to notify the relevant Hitachi sales offices when planning to use the products in MEDICAL APPLICATIONS.



Hitachi, Ltd.

Semiconductor & IC Div.
Karukozaka MN Bldg., 2-1, Ageha-cho, Shinjuku-ku, Tokyo 162, Japan
Tel: Tokyo (03) 266-9359
Fax: (03) 235-2375

For further information write to:

Hitachi America, Ltd.
Semiconductor & IC Div.
2000 Sierra Point Parkway
Brisbane, CA. 94005-1819,
U S A
Tel: 415-589-8300
Fax: 415-583-4207

Hitachi Europe GmbH
Electronic Components Div.
Central Europe Headquarters
Hans-Pinsel-Straße 10A,
8013 Haar bei München,
West Germany
Tel: 089-46140
Fax: 089-463068

Hitachi Europe Ltd.
Electronic Components Div.
Northern Europe Headquarters
21 Upton Road,
Watford, Herts WD1 7TB,
United Kingdom
Tel: 0923-246488
Fax: 0923-224422

Hitachi Asia (Hong Kong) Ltd.
Unit 706, North Tower,
World Finance Centre,
Harbour City, Canton Road,
Tsimshatsui, Kowloon,
Hong Kong
Tel: 852-3-7359218
Fax: 852-3-7306071