

### GENERAL DESCRIPTION

The CM2838 family is a positive voltage linear regulator developed utilizing CMOS technology featured low quiescent current (30 $\mu$ A typ.), low dropout voltage, and high output voltage accuracy, making them ideal for battery applications. EN input connected to CMOS has low bias current. The space-saving SOT-23-5 package is attractive for "Pocket" and "Hand Held" applications.

These rugged devices have both Thermal Shutdown, and Current limit to prevent device failure under the "Worst" of operating conditions.

In application requiring a low noise, regulated supply, place a 1000pF capacitor between Bypass and Ground.

The CM2838 is stable with a Low ESR output capacitance of 1.0 $\mu$ F or greater.

### FEATURES

- ◆ Very Low Dropout Voltage
- ◆ Low Current Consumption: Typ. 30 $\mu$ A, Max. 35 $\mu$ A
- ◆ Output Voltage: 1.8V, 2.5V, 2.8V, 3.0V, and 3.3V
- ◆ High Accuracy Output Voltage: +/- 1.5%
- ◆ Guaranteed 300mA Output
- ◆ Input Range up to 7.0V
- ◆ Thermal Shutdown
- ◆ Current Limiting
- ◆ Stability with Low ESR Capacitors
- ◆ Compact Package: SOT-23-5
- ◆ Factory Pre-set Output Voltages
- ◆ Low Temperature Coefficient

### APPLICATIONS

- ◆ Battery-powered devices
- ◆ Personal communication devices
- ◆ Home electric/electronic appliances
- ◆ PC peripherals

### TYPICAL APPLICATIONS

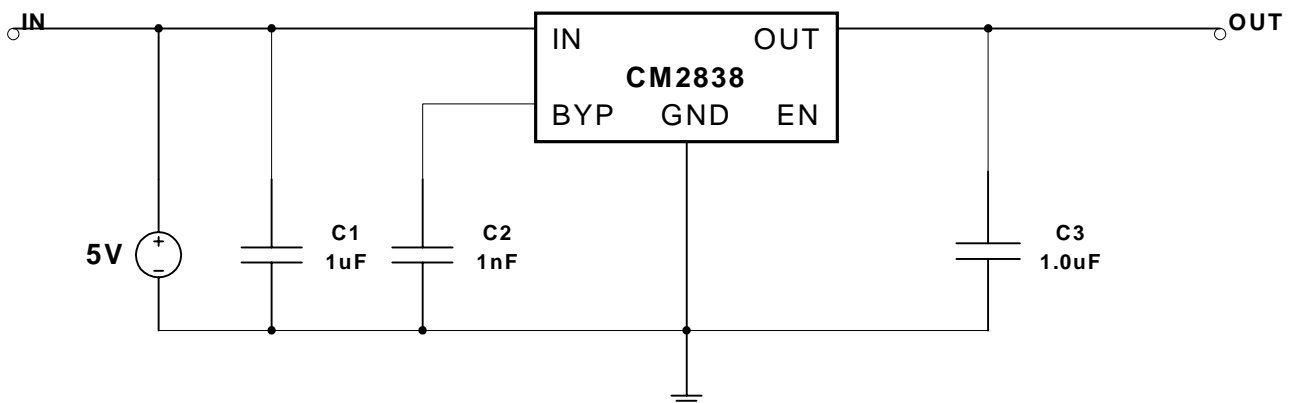

### PIN CONFIGURATION

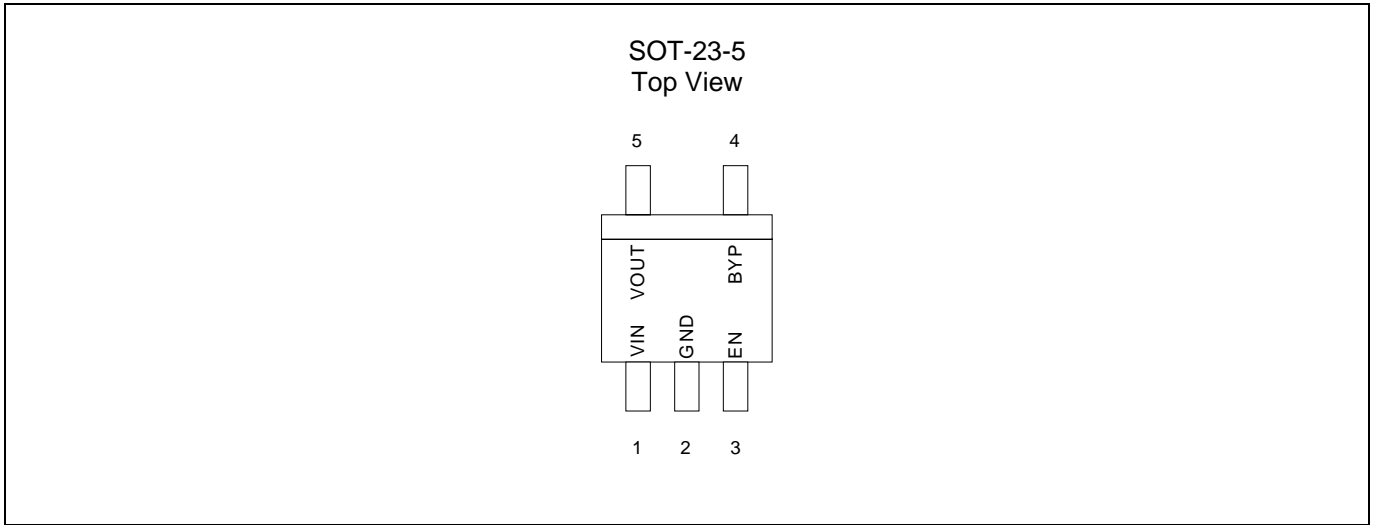

### BLOCK DIAGRAM

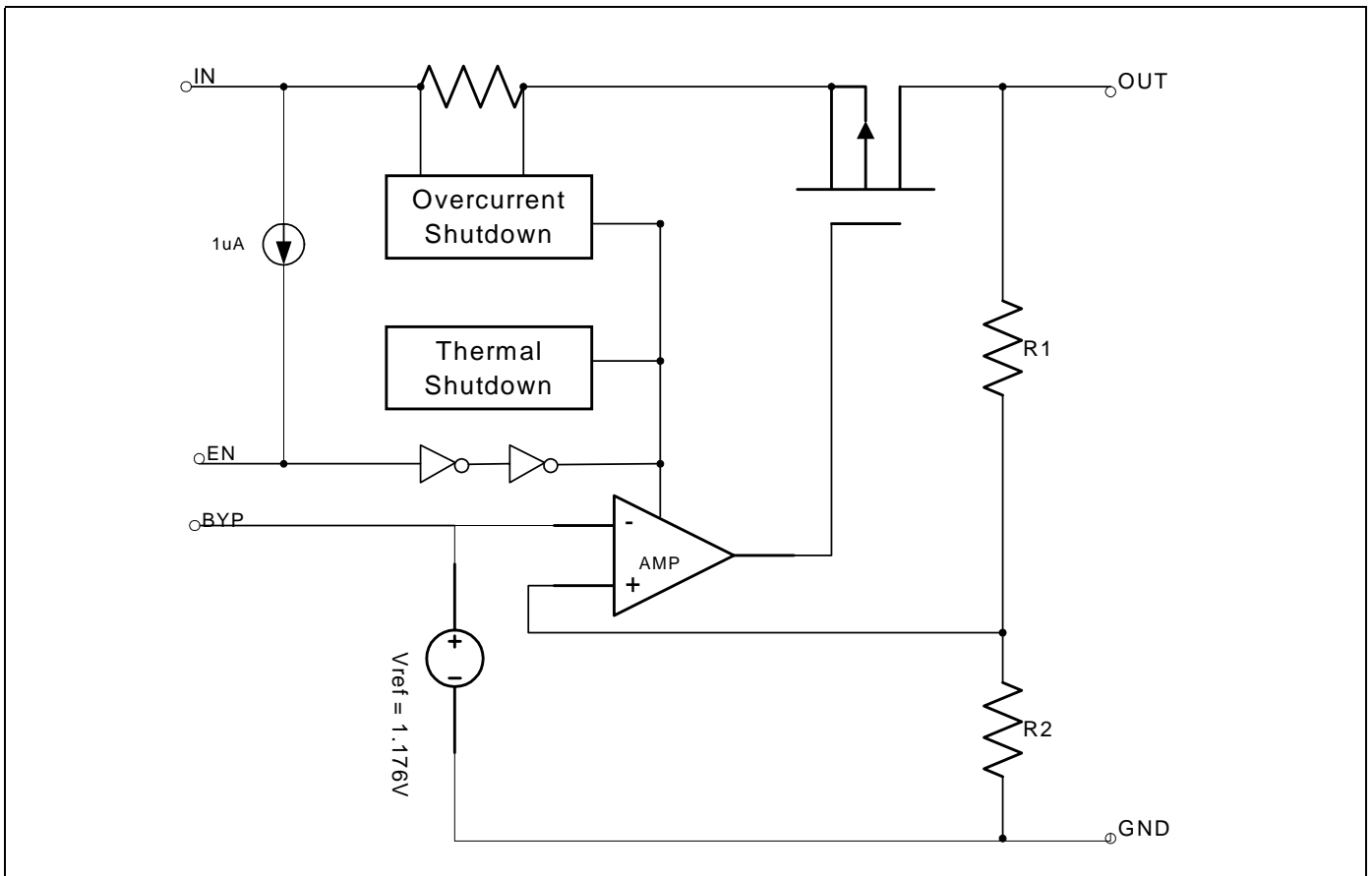

**ORDERING INFORMATION**

Part Number	Output Voltage	Temperature Range	Package
CM2838DIM25	1.8V	-40 ~ +85	SOT-23-5
CM2838KIM25	2.5V	-40 ~ +85	SOT-23-5
CM2838NIM25	2.8V	-40 ~ +85	SOT-23-5
CM2838PIM25	3.0V	-40 ~ +85	SOT-23-5
CM2838SIM25	3.3V	-40 ~ +85	SOT-23-5
CM2838GDIM25	1.8V	-40 ~ +85	SOT-23-5
CM2838GKIM25	2.5V	-40 ~ +85	SOT-23-5
CM2838GNIM25	2.8V	-40 ~ +85	SOT-23-5
CM2838GPIM25	3.0V	-40 ~ +85	SOT-23-5
CM2838GSIM25	3.3V	-40 ~ +85	SOT-23-5

Note: For other pre-set output voltage requirements, please contact Champion Sales office.

**ABSOLUTE MAXIMUM RATINGS**

Input Voltage ..... +7V  
Output Current .....  $P_D / (V_{IN} - V_o)$  mA  
Output Voltage ..... GND-0.3V to  $V_{IN}+0.3V$   
ESD Classification ..... B

**OPERATING RATINGS**

Ambient Temperature Range ( $T_A$ ) ..... -40 to +85  
Junction Temperature Range ..... -40 to +125

**THERMAL INFORMATION**

Parameter		Maximum	Unit
Thermal Resistance ( $\theta_{jc}$ )	SOT-23-5	160	/W
Internal Power Dissipation ( $P_D$ ) ( $T = 100^\circ C$ )	SOT-23-5	250	mW
Maximum Junction Temperature		150	
Maximum Lead Temperature (10 Sec)		300	

Caution: Stress above the listed absolute rating may cause permanent damage to the device.

### ELECTRICAL CHARACTERISTICS

$T_A = +25$  ; unless otherwise noted

Parameter	Symbol	Test Conditions	CM2838			Unit
			Min.	Typ.	Max.	
Input Voltage	$V_{IN}$		<b>Note 1</b>		7	V
Output Voltage Accuracy	$V_{OUT}$	$I_O = 1\text{mA to } 300\text{mA}$	-1.5		1.5	%
Dropout Voltage	$V_{DROPOUT}$	$I_O = 300\text{mA},$ $V_{OUT} = V_{O(NOM)} - 1.5\%$	$1.2\text{V} < V_{O(NOM)} \leq 2.0\text{V}$		1300	mV
			$2.0\text{V} < V_{O(NOM)} \leq 2.5\text{V}$		800	
			$2.5\text{V} < V_{O(NOM)}$		300	
Output Current	$I_O$	$V_{OUT} > 1.2\text{V}$	300			mA
Current Limit	$I_{LIM}$	$V_{OUT} > 1.2\text{V}$	300	450		mA
Quiescent Current	$I_Q$	$I_O = 0\text{mA}$		30	35	$\mu\text{A}$
Ground Pin Current	$I_{GND}$	$I_O = 1\text{mA to } 300\text{mA}$		30	50	$\mu\text{A}$
Line Regulation	$REG_{LINE}$	$I_{OUT} = 5\text{mA}, V_{IN} = V_{OUT} + 1 \text{ to } V_{OUT} + 2$	-0.1	0.02	0.1	%
Load Regulation	$REG_{LOAD}$	$I_O = 1\text{mA to } 300\text{mA}$		0.2	1	%
Over Temperature Shutdown	OTS			150		
Over Temperature Hysteresis	OTH			30		
$V_{OUT}$ Temperature Coefficient	TC			40		ppm/
Power Supply Rejection	PSRR	$I_O = 100\text{mA}$ $C_O = 2.2\mu\text{F ceramic}$	$f = 1\text{kHz}$		60	dB
			$f = 10\text{kHz}$		50	
			$f = 100\text{kHz}$		40	
Power Supply Rejection	PSRR	$I_O = 100\text{mA}$ $C_O = 2.2\mu\text{F ceramic}$ $C_{BYP} = 0.01\mu\text{F}$	$f = 1\text{kHz}$		75	dB
			$f = 10\text{kHz}$		55	
			$f = 100\text{kHz}$		30	
Output Voltage Noise	eN	$f = 10\text{Hz to } 100\text{kHz}$ $I_O = 10\text{mA}, C_{BYP} = 0\mu\text{F}$	$C_O = 2.2\mu\text{F}$		30	$\mu\text{Vrms}$
			$C_O = 100\mu\text{F}$		20	
Output Voltage Noise	eN	$f = 10\text{Hz to } 100\text{kHz}$ $I_O = 10\text{mA}, C_{BYP} = 0.01\mu\text{F}$	$C_O = 2.2\mu\text{F}$		30	$\mu\text{Vrms}$
			$C_O = 100\mu\text{F}$		20	
Shutdown Supply Current	$I_{SD}$	$V_{IN} = 5.0\text{V}, V_{OUT} = 0\text{V}, V_{EN} < V_{EL}$		2.0	3.0	$\mu\text{A}$
EN Input Bias Current	$I_{EH}$	$V_{EN} = V_{IN}, V_{IN} = 2.6\text{V to } 7\text{V}$			0.1	$\mu\text{A}$
	$I_{EL}$	$V_{EN} = 0, V_{IN} = 2.6\text{V to } 7\text{V}$		2.0	3.0	$\mu\text{A}$
EN Input Threshold	$V_{EH}$	$V_{IN} = 2.6\text{V to } 7\text{V}$	2		$V_{IN}$	V
	$V_{EL}$	$V_{IN} = 2.6\text{V to } 7\text{V}$	0		0.4	V

**Note 1.**  $V_{IN(MIN)} = V_{OUT} + V_{DROPOUT}$

### DETAILED DESCRIPTION

The CM2838 family of CMOS regulators contain a PMOS pass transistor, voltage reference, error amplifier, over-current protection, thermal shutdown.

The P-channel pass transistor receives data from the error amplifier, over-current protection, and thermal protection circuits. During normal operation, the error amplifier compares the output voltage to a precision reference. Over-current and Thermal shutdown circuits become active when the junction temperature exceeds 150 °C, or the current exceeds 300mA. During thermal shutdown, the output voltage remains low. Normal operation is restored when the junction temperature drops below 120 °C.

The CM2838 switches from voltage mode to current mode when the load exceeds the rated output current. This prevents over-stress.

### ENABLE

The Enable pin normally floats high. When actively, pulled low, the PMOS pass transistor shut off, and all internal circuits are powered down. In this state, the quiescent current is less than 2 $\mu$ A. This pin behaves much like an electronic switch.

### EXTERNAL CAPACITOR

The CM2838 is stable with a Low ESR output capacitor to ground of 1.0 $\mu$ F or greater. It can keep stable even with higher ESR capacitors. A second capacitor is recommended between the input and ground to stabilize VIN. The input capacitor should be larger than 0.1 $\mu$ F to have a beneficial effect. All capacitors should be placed in close proximity to the pins. A “quiet” ground termination is desirable.

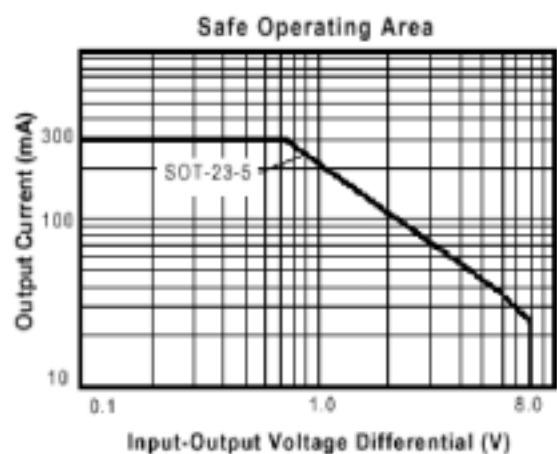
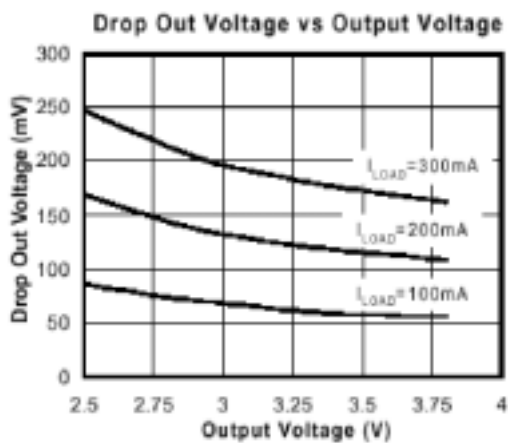
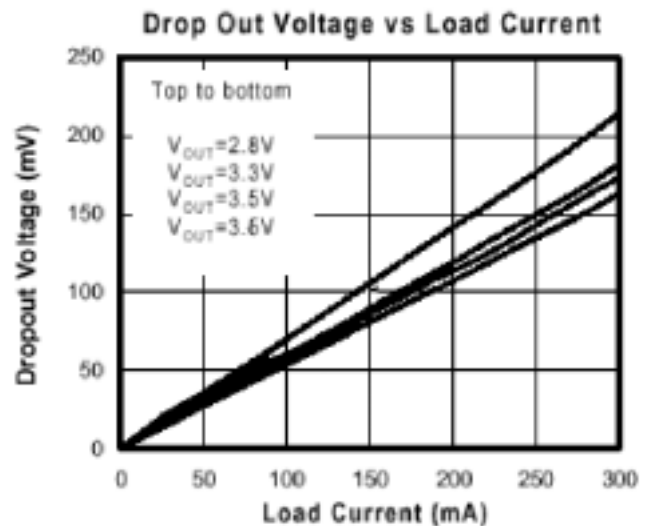
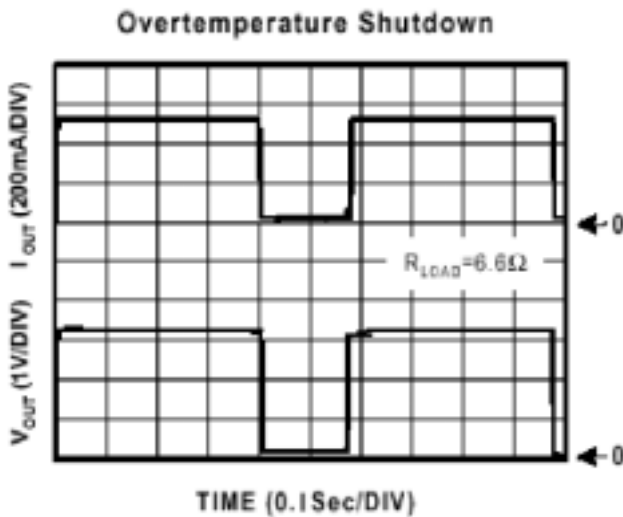
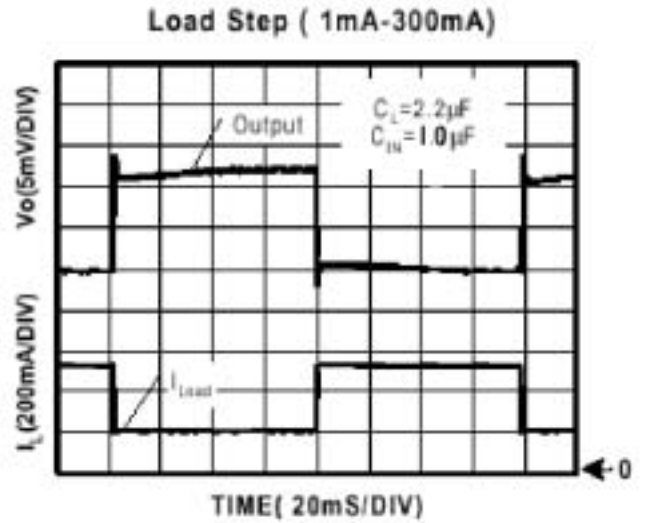
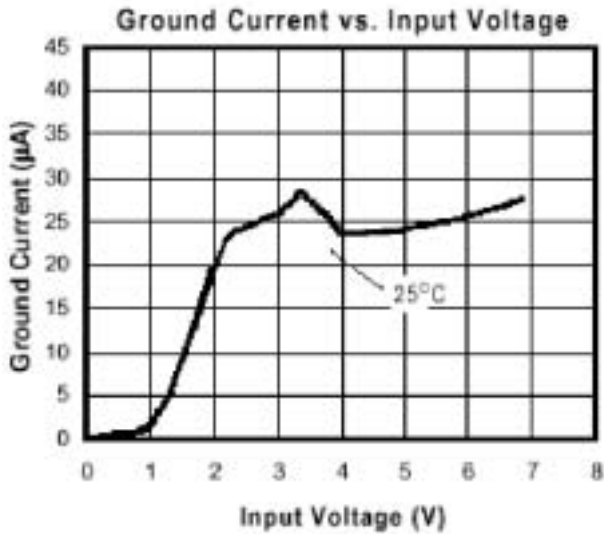
**TYPICAL CHARACTERISTICS**

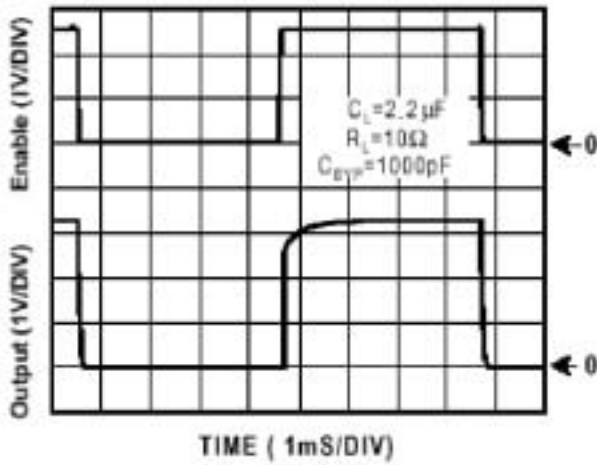
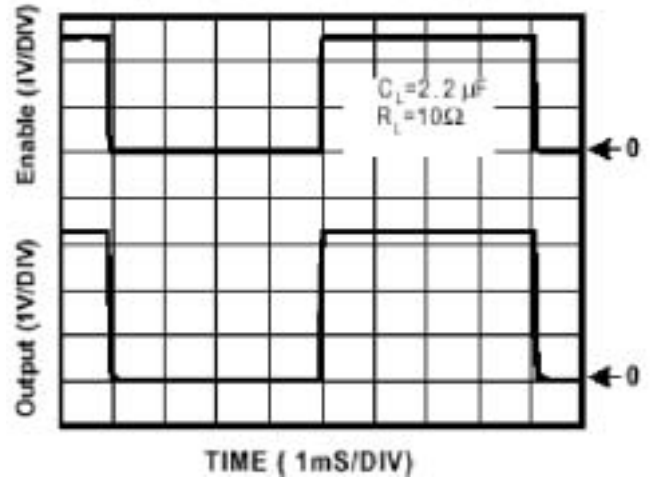
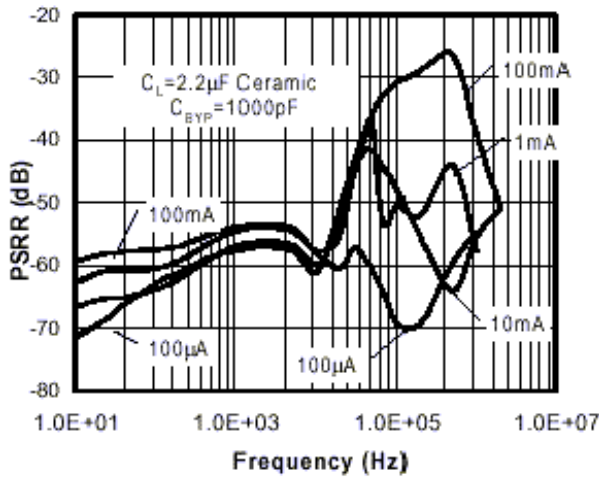
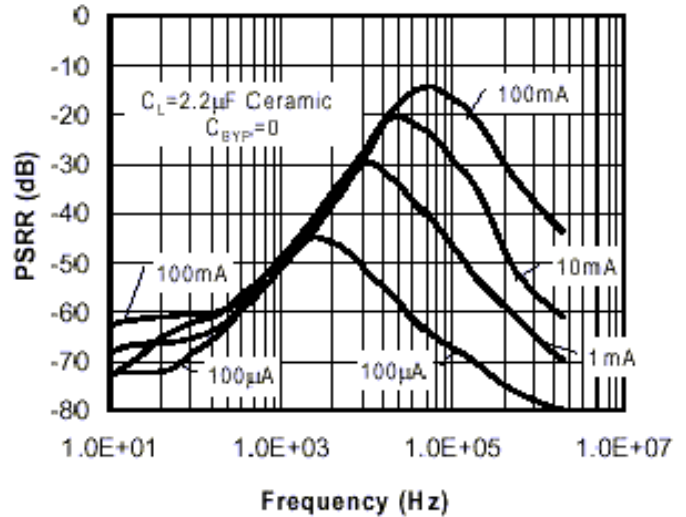
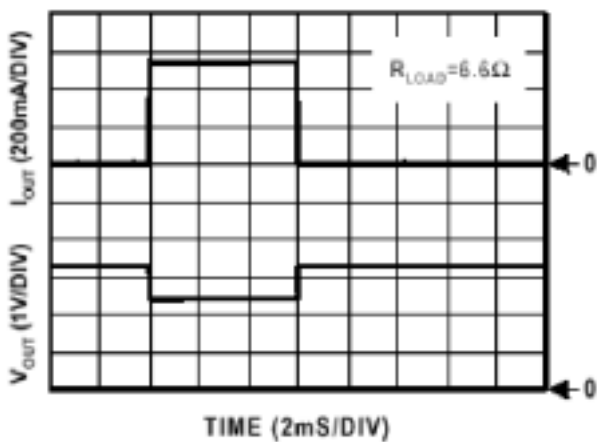
**Chip Enable Transient Response**

**Chip Enable Transient Response**

**Power Supply Rejection Ratio**

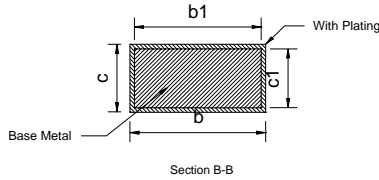
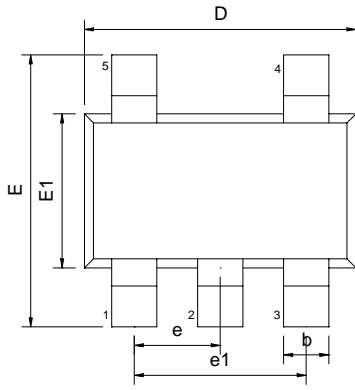
**Power Supply Rejection Ratio**

**Current Limit Response**

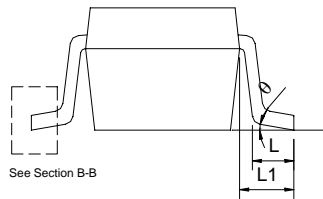
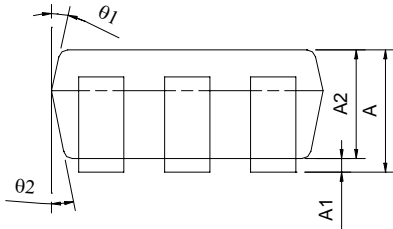
### PACKAGE DIMENSION

#### SOT-23-5 (M25)



SYMBOLS	DIMENSIONS IN MILLIMETERS			DIMENSIONS IN INCHES		
	MIN	NOM	MAX	MIN	NOM	MAX
A	1.05	---	1.35	0.041	---	0.053
A1	0.05	---	0.15	0.002	---	0.006
A2	1.00	1.10	1.20	0.039	0.043	0.047
b	0.25	---	0.50	0.010	---	0.020
b1	0.25	0.40	0.45	0.010	0.016	0.018
c	0.08	---	0.20	0.003	---	0.008
c1	0.08	0.11	0.15	0.003	0.004	0.006
D	2.70	2.90	3.00	0.106	0.114	0.118
E	2.60	2.80	3.00	0.102	0.110	0.118
E1	1.50	1.60	1.70	0.059	0.063	0.067
L	0.35	0.45	0.55	0.014	0.018	0.022
L1	0.60 REF			0.024 REF		
e	0.95 BSC			0.037 BSC		
e1	1.90 BSC			0.075 BSC		
θ	0°	5°	10°	0°	5°	10°
θ1	3°	5°	7°	3°	5°	7°
θ2	6°	8°	10°	6°	8°	10°





**NUMBERING SCHEME**
**Ordering Number: CM2838XYZ (note1)**
**Ordering Number: CM2838GXYZ (note2)**
**note1:**

CM2838: 300mA CMOS LDO with enable

X : Suffix for voltage output (note 3)

Y : Suffix for Temperature Range (note 4)

Z : Suffix for Package Type (note 5)

**note2:**

CM2838: 300mA CMOS LDO with enable

G : Suffix for Pb Free Product

X : Suffix for voltage output (note 3)

Y : Suffix for Temperature Range (note 4)

Z : Suffix for Package Type (note 5)

**note 3:** see CMOS LDO Voltage Suffix Table

**CM2838 will provide options of D(1.8V), K(2.5V), N(2.8V), P(3.0V), S(3.3V)**
**note 4:**

Y= I : -40 ~+85 (only I grade support for all CMOS LDOs)

**note 5:**

Z is single alphabet with or without digits

M25 : SOT-25 (TR only)

**CMOS LDO Voltage Suffix Table**

Output Voltage	Suffix	Output Voltage	Suffix
1.5V	A	3.0V	P
1.6V	B	3.1V	Q
1.7V	C	3.2V	R
1.8V	D	3.3V	S
1.9V	E	3.4V	T
2.0V	F	3.5V	U
2.1V	G	3.6V	V
2.2V	H	3.7V	W
2.3V	I	3.8V	X
2.4V	J	3.9V	Y
2.5V	K	4.0V	Z
2.6V	L		
2.7V	M		
2.8V	N		
2.9V	O		

### IMPORTANT NOTICE

Champion Microelectronic Corporation (CMC) reserves the right to make changes to its products or to discontinue any integrated circuit product or service without notice, and advises its customers to obtain the latest version of relevant information to verify, before placing orders, that the information being relied on is current.

A few applications using integrated circuit products may involve potential risks of death, personal injury, or severe property or environmental damage. CMC integrated circuit products are not designed, intended, authorized, or warranted to be suitable for use in life-support applications, devices or systems or other critical applications. Use of CMC products in such applications is understood to be fully at the risk of the customer. In order to minimize risks associated with the customer's applications, the customer should provide adequate design and operating safeguards.

#### HsinChu Headquarter

---

5F, No. 11, Park Avenue II,  
Science-Based Industrial Park,  
HsinChu City, Taiwan  
TEL: +886-3-567 9979  
FAX: +886-3-567 9909

#### Sales & Marketing

---

11F, No. 306-3, SEC. 1, Ta Tung Road,  
Hsichih, Taipei Hsien 221, Taiwan  
TEL: +886-2-8692 1591  
FAX: +886-2-8692 1596

---