

KSB834

PNP SILICON EPITAXIAL TRANSISTOR

T-33-19

LOW FREQUENCY POWER AMPLIFIER

• Complement to KSD880

ABSOLUTE MAXIMUM RATINGS (T_a = 25°C)

Characteristic	Symbol	Rating	Unit
Collector-Base Voltage	V _{CB0}	-60	V
Collector-Emitter Voltage	V _{CE0}	-60	V
Emitter-Base Voltage	V _{EB0}	-7	V
Collector Current	I _c	-3	A
Base Current	I _b	-0.5	A
Collector Dissipation (T _a = 25°C)	P _c	1.5	W
Collector Dissipation (T _c = 25°C)	P _c	30	W
Junction Temperature	T _j	150	°C
Storage Temperature	T _{stg}	-55~150	°C

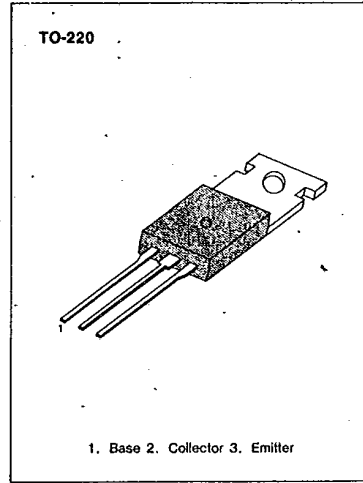

3

ELECTRICAL CHARACTERISTICS (T_a = 25°C)

Characteristic	Symbol	Test Condition	Min	Typ	Max	Unit
Collector Cutoff Current	I _{CB0}	V _{CB} = -60V, I _E = 0			-100	μA
Emitter Cutoff Current	I _{EB0}	V _{EB} = -7V, I _C = 0			-100	μA
Collector-Emitter Breakdown Voltage	BV _{CE0}	I _C = -50mA, I _B = 0	-60			V
DC Current Gain	h _{FE1}	V _{CE} = -5V, I _C = -0.5A	60		200	
	h _{FE2}	V _{CE} = -5V, I _C = -3A	20			
Collector Emitter Saturation Voltage	V _{CE (sat)}	I _C = -3A, I _B = -0.3A		-0.5	-1	V
Base Emitter On Voltage	V _{BE (on)}	V _{CE} = -5V, I _C = -0.5A		-0.7	-1	V
Current Gain Bandwidth Product	f _T	V _{CE} = -5V, I _C = -0.5A		9		MHz
Collector Output Capacitance	C _{ob}	V _{CB} = -10V, I _E = 0 f = 1MHz		150		pF
Turn on Time	t _{on}			0.4		μs
Storage Time	t _s	-I _{B1} = I _{B2} = 0.2A		1.7		μs
Fall Time	t _f	V _{CC} = -30V		0.5		μs

h_{FE}(1) CLASSIFICATION

Classification	O	Y
h _{FE} (1)	60-120	100-200

KSB834

PNP SILICON EPITAXIAL TRANSISTOR

F-33-19

STATIC CHARACTERISTIC

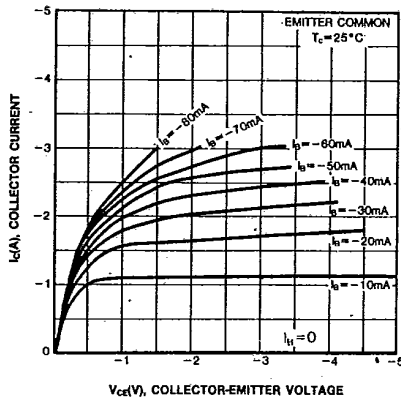

DC CURRENT GAIN

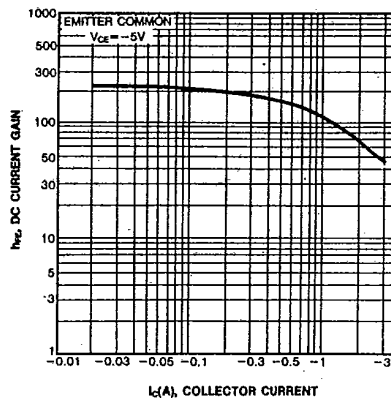

BASE-EMITTER ON VOLTAGE

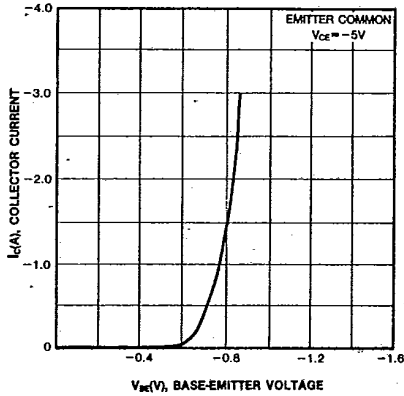

COLLECTOR-EMITTER SATURATION VOLTAGE vs COLLECTOR CURRENT

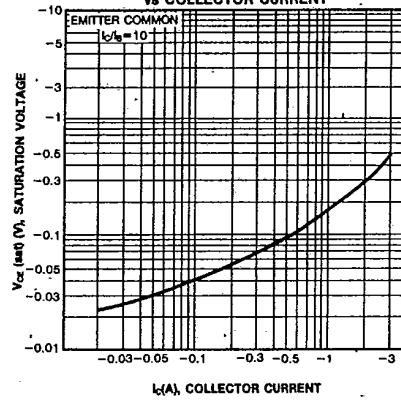

SAFE OPERATING AREA

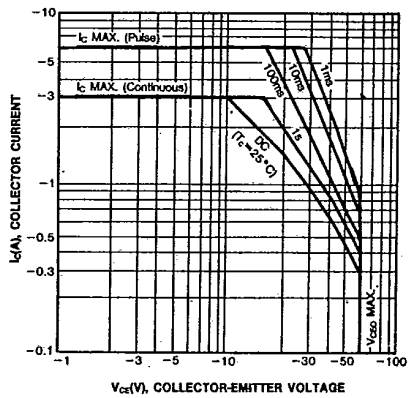

POWER DERATING

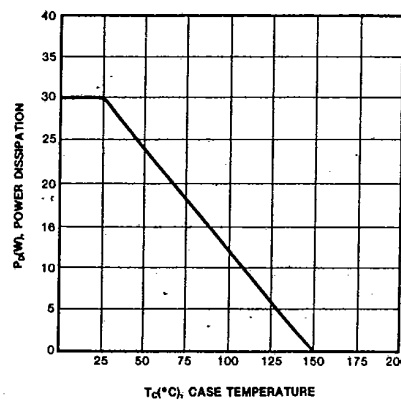

KSB1149

PNP SILICON DARLINGTON TRANSISTOR

T-33-31

HIGH DC CURRENT GAIN
LOW COLLECTOR SATURATION VOLTAGE
BUILT-IN A DAMPER DIODE AT E-C

HIGH POWER DISSIPATION: $P_T=1.3W$ ($T_a=25^\circ C$)

ABSOLUTE MAXIMUM RATINGS ($T_a=25^\circ C$)

Characteristic	Symbol	Rating	Unit
Collector-Base Voltage	V_{CB0}	-100	V
Collector-Emitter Voltage	V_{CE0}	-100	V
Emitter-Base Voltage	V_{EB0}	-8	V
Collector Current (DC)	I_C	-3	A
Collector Current (Pulse)	I_C	-5	A
Collector Dissipation ($T_a=25^\circ C$)	P_C	1.3	W
Collector Dissipation ($T_c=25^\circ C$)	P_C	15	W
Junction Temperature	T_J	150	$^\circ C$
Storage Temperature	T_{stg}	-55~150	$^\circ C$

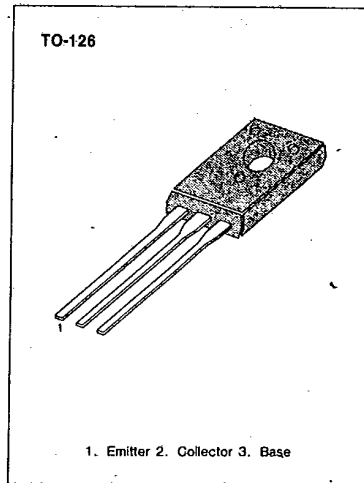

1. Emitter 2. Collector 3. Base

3

* $PW \leq 10ms$, Duty Cycle $\leq 50\%$

ELECTRICAL CHARACTERISTICS ($T_a=25^\circ C$)

Characteristic	Symbol	Test Condition	Min	Typ	Max	Unit
Collector Cutoff Current	I_{CB0}	$V_{CB} = -100V, I_E = 0$			-10	μA
Emitter Cutoff Current	I_{EB0}	$V_{EB} = -5V, I_C = 0$			-2	mA
* DC Current Gain	h_{FE1}	$V_{CE} = -2V, I_C = -1.5A$	2000		15000	
	h_{FE2}	$V_{CE} = -2V, I_C = -3A$	1000			
* Collector-Emitter Saturation Voltage	$V_{CE(sat)}$	$I_C = -1.5A, I_B = -1.5mA$		-0.9	-1.2	V
* Base-Emitter Saturation Voltage	$V_{BE(sat)}$	$I_C = -1.5A, I_B = -1.5mA$		-1.5	-2	V
Turn On Time	t_{on}	$I_C = -1.5A$		0.5		μS
Storage Time	t_{stg}	$I_{B1} = -I_{B2} = -1.5mA$		2		μS
Fall Time	t_f	$R_L = 27\Omega, V_{CC} = -40V$		1		μS

* Pulse test: $PW \leq 350\mu s$, duty cycle $\leq 2\%$ Pulsed

$h_{FE}(1)$ CLASSIFICATION

Classification	O	Y	G
h_{FE1}	2000-5000	4000-12000	6000-20000

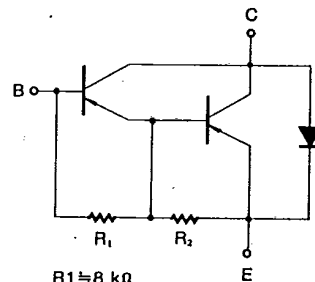

$R1 \approx 8 k\Omega$
 $R2 \approx 0.6 k\Omega$



KSB1149

PNP SILICON DARLINGTON TRANSISTOR

T-33-31

POWER DERATING

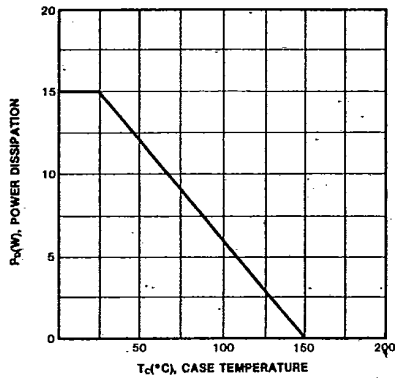

DERATING CURVE OF SAFE OPERATING AREAS

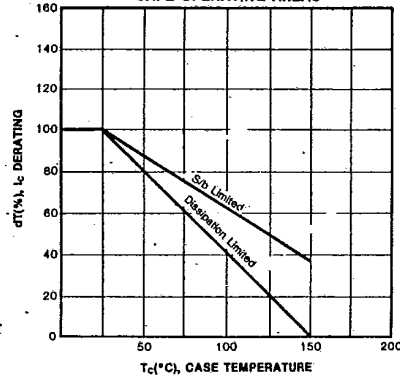

FORWARD BIAS SAFE OPERATING AREA

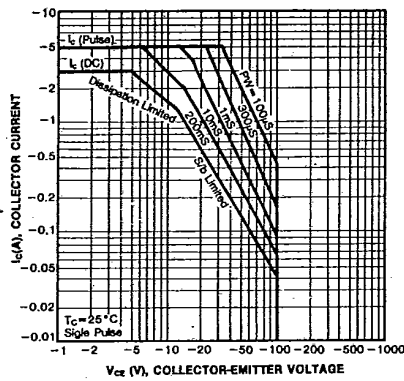

STATIC CHARACTERISTIC

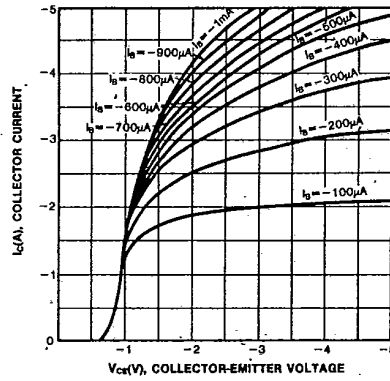

DC CURRENT GAIN

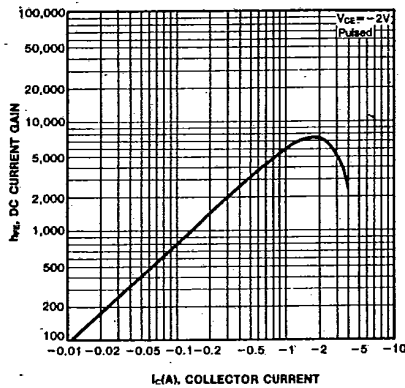

COLLECTOR-EMITTER SATURATION VOLTAGE, BASE-EMITTER SATURATION VOLTAGE

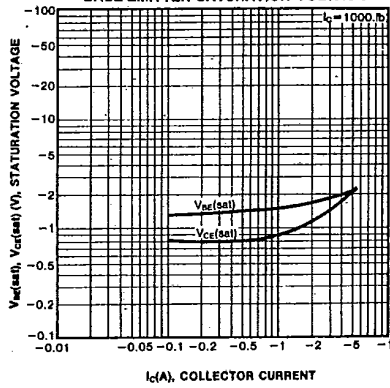

KSB1150

PNP SILICON DARLINGTON TRANSISTOR

T-33-31

HIGH DC CURRENT GAIN
LOW COLLECTOR SATURATION VOLTAGE
BUILT-IN A ZENER DIODE AT B-C AND
A DAMPER DIODE AT E-C

HIGH POWER DISSIPATION: $P_T = 1.3W$ ($T_a = 25^\circ C$)

ABSOLUTE MAXIMUM RATINGS ($T_a = 25^\circ C$)

Characteristic	Symbol	Rating	Unit
Collector-Base Voltage	V_{CB0}	-60 ± 10	V
Collector-Emitter Voltage	V_{CE0}	-60 ± 10	V
Emitter-Base Voltage	V_{EB0}	-8	V
Collector Current (DC)	I_C	-3	A
*Collector Current (Pulse)	I_C	-5	A
Collector Dissipation ($T_a = 25^\circ C$)	P_C	1.3	W
Collector Dissipation ($T_C = 25^\circ C$)	P_C	15	W
Junction Temperature	T_J	150	$^\circ C$
Storage Temperature	T_{stg}	$-55 \sim 150$	$^\circ C$

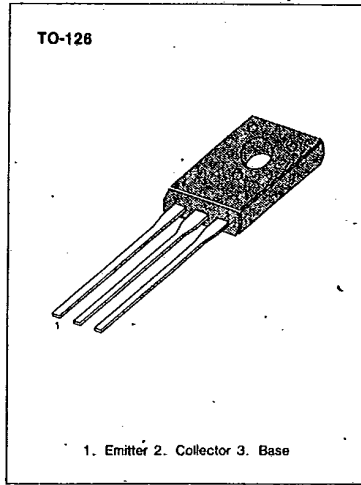

3

* $PW < 10ms$, Duty Cycle $< 50\%$

ELECTRICAL CHARACTERISTICS ($T_a = 25^\circ C$)

Characteristic	Symbol	Test Condition	Min	Typ	Max	Unit
Collector-Base Voltage	V_{CB0}	$I_C = -1mA, I_E = 0$	-50	-60	-70	V
Collector-Emitter Voltage	V_{CE0}	$I_C = -10mA, R_{BE} = \infty$	-50	-60	-70	V
Collector Cutoff Current	I_{CB0}	$V_{CB} = -40V, I_E = 0$			-10	μA
Emitter Cutoff Current	I_{EB0}	$V_{EB} = -5V, I_C = 0$			-2	mA
*DC Current Gain	h_{FE1}	$V_{CE} = -2V, I_C = -1.5A$	2000		15000	
	h_{FE2}	$V_{CE} = -2V, I_C = -3A$	1000			
*Collector-Emitter Saturation Voltage	$V_{CE(sat)}$	$I_C = -1.5A, I_B = -1.5mA$		-0.9	-1.2	V
*Base-Emitter Saturation Voltage	$V_{BE(sat)}$	$I_C = -1.5A, I_B = -1.5mA$		-1.5	-2	V
Turn On Time	t_{on}	$I_C = 1.5A$		0.5		μS
Storage Time	t_{stg}	$I_B1 = -I_B2 = 1.5mA$		2		μS
Fall Time	t_f	$R_L = 27\Omega, V_{CC} = 40V$		1		μS

* Pulse test: $PW < 350\mu s$, Duty Cycle $< 2\%$ Pulsed

$h_{FE}(1)$ CLASSIFICATION

Classification	O	Y	G
h_{FE1}	2000-5000	4000-12000	6000-20000

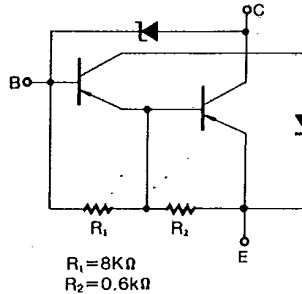

KSB1150

PNP SILICON DARLINGTON TRANSISTOR

T-33-31

