

HM6147H Series — Maintenance Only

4096-word x 1-bit High Speed CMOS Static RAM

FEATURES

- High Speed: Fast Access Time 35ns/45ns/55ns (max.)
- Low Power Standby and Low Power Operation, Standby: 100 μ W (typ.)/5 μ W (typ.) (L-version), Operation: 150mW typ.
- Single 5V Supply and High Density 18 Pin Package
- Completely Static Memory — No Clock nor Timing Strobe Required
- No Peak Power—On Current
- No Change of t_{ACS} with Short Chip Deselect Time
- Equal Access and Cycle Time
- Directly TTL Compatible — All Input and Output
- Separate Data Input and Output: Three State Output
- Plug-In Replacement with Intel 2147H NMOS STATIC RAM
- Capability of Battery Back Up Operation (L-version)

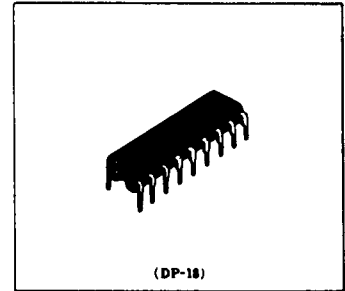

PIN ARRANGEMENT

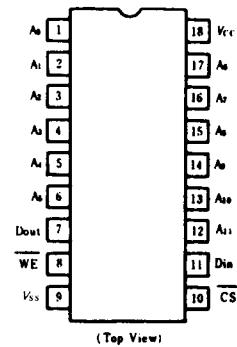

ORDERING INFORMATION

Type No.	Access Time	Package
HM6147HP-35	35ns	300mil 18pin Plastic DIP
HM6147HP-45	45ns	
HM6147HP-55	55ns	
HM6147HLP-35	35ns	
HM6147HLP-45	45ns	
HM6147HLP-55	55ns	

BLOCK DIAGRAM

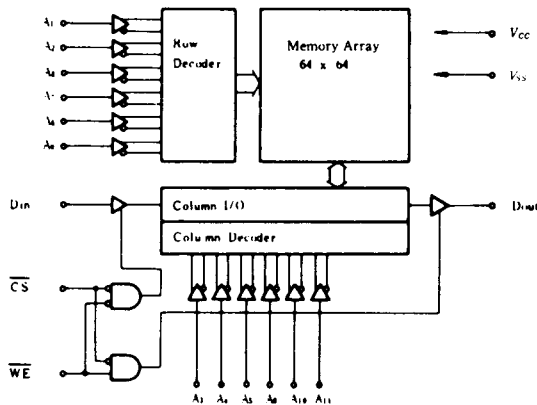

ABSOLUTE MAXIMUM RATINGS

Item	Symbol	Rating	Unit
Voltage on Any Pin relative to V_{SS}	V_T	-0.5 ¹ to +7.0	V
DC Output Current	I_o	20	mA
Power Dissipation	P_T	1.0	W
Operating Temperature	T_{op}	0 to +70	°C
Storage Temperature under bias	$T_{stg(bias)}$	-10 to +85	°C
Storage Temperature	T_{stg}	-55 to +125	°C

Note) *1 -3.5V for pulse width \leq 20ns



RECOMMENDED DC OPERATING CONDITIONS (0°C ≤ Ta ≤ 70°C)

Parameter	Symbol	min	typ	max	Unit
Supply Voltage	V _{CC}	4.5	5.0	5.5	V
	V _{SS}	0	0	0	V
Input High (logic 1) Voltage	V _{IH}	2.0	3.0	6.0	V
Input Low (logic 0) Voltage	V _{IL}	-0.5*1	-	0.8	V

Note) *1. -3.0V for pulse width ≤ 20ns

DC AND OPERATING CHARACTERISTICS (0°C ≤ Ta ≤ 70°C, V_{CC} = 5V ± 10%, V_{SS} = 0V)

Parameter	Symbol	Test Condition	min	typ*2	max	Unit
Input Leakage Current	I _{LI}	V _{CC} = 5.5V, V _{SS} to V _{CC}	-	-	10	μA
Output Leakage Current	I _{LO}	$\overline{CS} = V_{IH}$, V _{OL} = V _{SS} to V _{CC}	-	-	10	μA
Operating Power Supply Current(1)	I _{CC}	$\overline{CS} = V_{IL}$, Output open	-	30	80	mA
Operating Power Supply Current(2)	I _{CC1}	$\overline{CS} = V_{IL}$, Minimum Cycle	-	40	80	mA
Standby Power Supply Current (1)	I _{SB}	$\overline{CS} = V_{IH}$, V _{CC} = Min to Max	-	8	20	mA
			-	5*3	15*3	
Standby Power Supply Current (2)	I _{SB1}	$\overline{CS} \geq V_{CC} - 0.2V$, V _{IN} ≥ 0.2V or V _{IN} ≥ V _{CC} - 0.2V	-	20	800	μA
			-	1*3	100*3	
Output Low Voltage	V _{OL}	I _{OL} = 8mA	-	-	0.40	V
Output High Voltage	V _{OH}	I _{OH} = -4mA	2.4	-	-	V

Notes) *1. The operating ambient temperature range is guaranteed with transverse air flow exceeding 400 linear feet minute.
 *2. Typical limits are at V_{CC} = 5.0V, Ta = 25°C and Specified loading.
 *3. This characteristics are guaranteed only for L-version.

CAPACITANCE (Ta = 25°C, f = 1.0MHz)

Item	Symbol	Conditions	max	Unit
Input Capacitance	C _i	V _i = 0V	5	pF
Output Capacitance	C _o	V _o = 0V	6	pF

Note) This parameter is sampled and not 100% tested.

AC CHARACTERISTICS (Ta = 0 to +70°C, V_{CC} = 5V ± 10%)

AC TEST CONDITIONS

- Input pulse levels: V_{SS} to 3.0V
- Input rise and fall times: 5 ns
- Input timing reference levels: 1.5V
- Output load: See Figure
- Output timing reference levels: 1.5V (HM6147H-35)
0.8 to 2.0V (HM6147H-45/55)

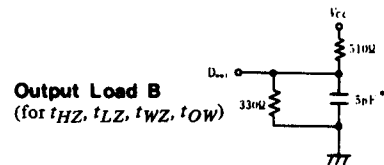
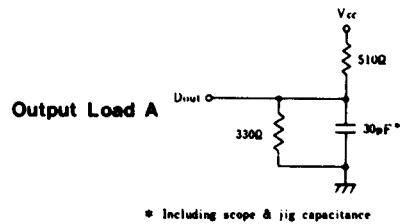

● READ CYCLE

Parameter	Symbol	HM6147H-35		HM6147H-45		HM6147H-55		Unit	Notes
		min	max	min	max	min	max		
Read Cycle Time	t_{AC}	35	—	45	—	55	—	ns	(1)
Address Access Time	t_{AA}	—	35	—	45	—	55	ns	
Chip Select Access Time	t_{ACS}	—	35	—	45	—	55	ns	
Output Hold from Address Change	t_{OH}	5	—	5	—	5	—	ns	
Chip Selection to Output in Low Z	t_{LZ}	5	—	5	—	5	—	ns	(2), (3), (7)
Chip Deselection to Output in High Z	t_{HZ}	0	30	0	30	0	30	ns	(2), (3), (7)
Chip Selection to Power Up Time	t_{PU}	0	—	0	—	0	—	ns	
Chip Deselection to Power Down Time	t_{PD}	—	20	—	20	—	20	ns	

● TIMING WAVEFORM OF READ CYCLE NO.1 (4) (5)

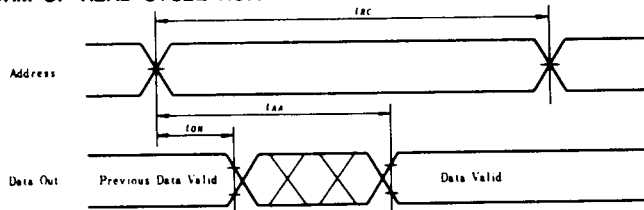

● TIMING WAVEFORM OF READ CYCLE NO.2 (4) (6)

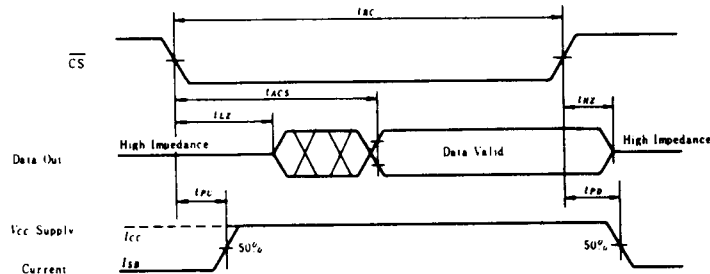

- Notes:
1. All Read Cycle timings are referenced from last valid address to the first transitioning address.
 2. At any given temperature and voltage condition, t_{HZ} max. is less than t_{LZ} min. both for a given device and from device to device.
 3. Transition is measured $\pm 500\text{mV}$ from steady state voltage with specified loading in Load B.
 4. \overline{WE} is high for READ Cycle.
 5. Device is continuously selected, $\overline{CS}=V_{IL}$.
 6. Addresses valid prior to or coincident with \overline{CS} transition low.
 7. This parameter is sampled and not 100% tested.



● WRITE CYCLE

Parameter	Symbol	HM6147H-35		HM6147H-45		HM6147H-55		Unit	Notes
		min	max	min	max	min	max		
Write Cycle Time	t_{wc}	35	—	45	—	55	—	ns	(2)
Chip Selection to End of Write	t_{cw}	35	—	45	—	45	—	ns	
Address Valid to End of Write	t_{aw}	35	—	45	—	45	—	ns	
Address Setup Time	t_{as}	0	—	0	—	0	—	ns	
Write Pulse Width	t_{wp}	20	—	25	—	30	—	ns	
Write Recovery Time	t_{wr}	0	—	0	—	0	—	ns	
Data Valid to End of Write	t_{dw}	20	—	25	—	25	—	ns	
Data Hold Time	t_{dh}	10	—	10	—	10	—	ns	
Write Enabled to Output in High Z	t_{wz}	0	20	0	25	0	30	ns	(3), (4)
Output Active from End of Write	t_{ow}	0	—	0	—	0	—	ns	(3), (4)

● TIMING WAVEFORM OF WRITE CYCLE (\overline{WE} Controlled)

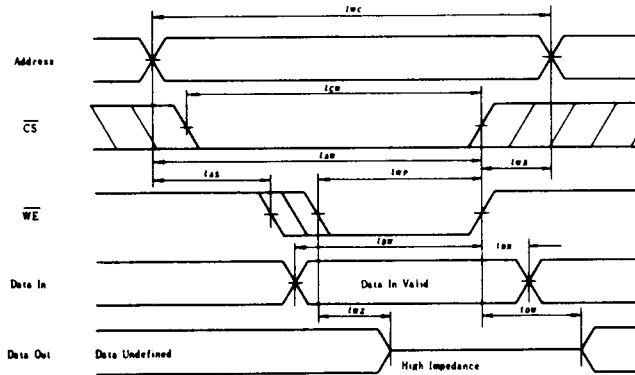

● TIMING WAVEFORM OF WRITE CYCLE (\overline{CS} Controlled)

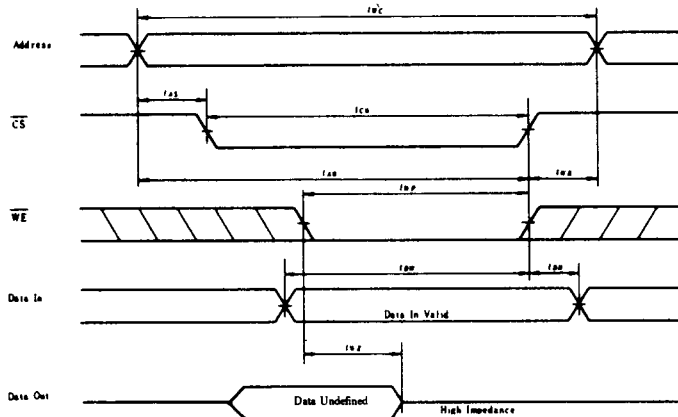

- Notes:
1. If \overline{CS} goes high simultaneously with \overline{WE} high, the output remains in a high impedance states.
 2. All Write Cycle timings are referenced from the last valid address to the first transitioning address.
 3. Transition is measured $\pm 500mV$ from steady state voltage with specified loading in Load B.
 4. This parameter is sampled and not 100% tested.
 5. \overline{CS} or \overline{WE} is high for address transition.



LOW V_{CC} DATA RETENTION CHARACTERISTICS (T_a=0°C to +70°C)

This characteristics are guaranteed only for L-version.

Item	Symbol	Test Condition	min	typ	max	Unit
V _{CC} for Data Retention	V _{DR}	$\overline{CS} \geq V_{CC} - 0.2V$ $V_{IN} \geq V_{CC} - 0.2V$ or $V_{IN} \leq 0.2V$	2.0	—	—	V
Data Retention Current	I _{CCDR}	V _{CC} = 3.0V, $\overline{CS} \geq 2.8V$ $V_{IN} \geq 2.8V$ or $V_{IN} \leq 0.2V$	—	—	50	μA
Chip Deselect to Data Retention Time	t _{CDR}	See Retention Waveform	0	—	—	ns
Operation Recovery Time	t _R		t _{RC} *1	—	—	ns

Note) *1. t_{RC} = Red Cycle Time.

LOW V_{CC} DATA RETENTION WAVEFORM

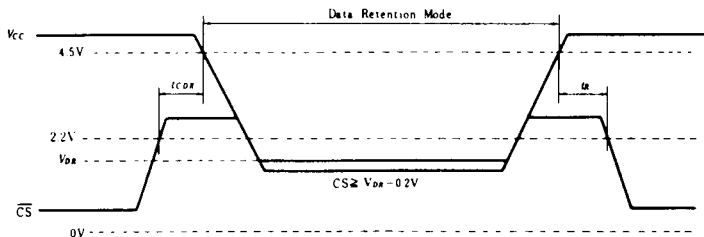

ACCESS TIME VS. SUPPLY VOLTAGE

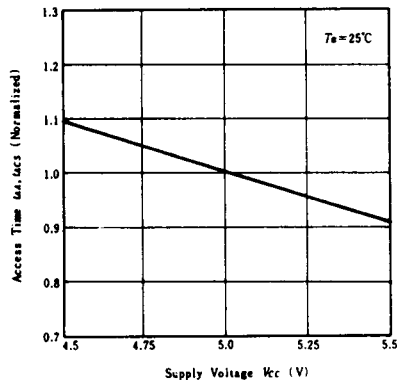

ACCESS TIME VS. AMBIENT TEMPERATURE

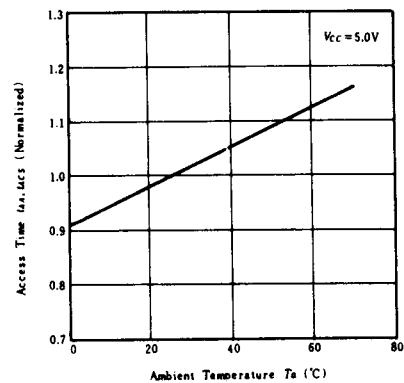

ACCESS TIME VS. LOAD CAPACITANCE

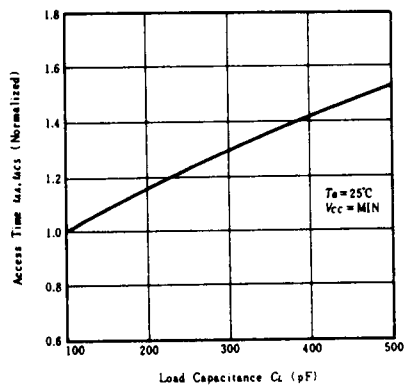

SUPPLY CURRENT VS. FREQUENCY

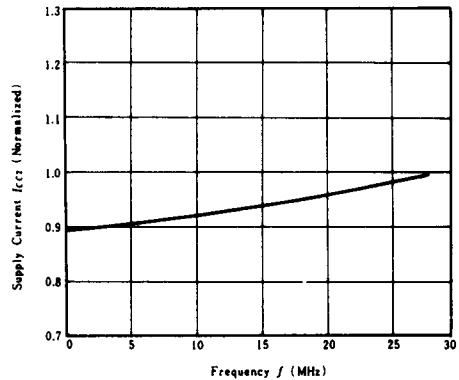

INPUT LOW VOLTAGE VS. SUPPLY VOLTAGE

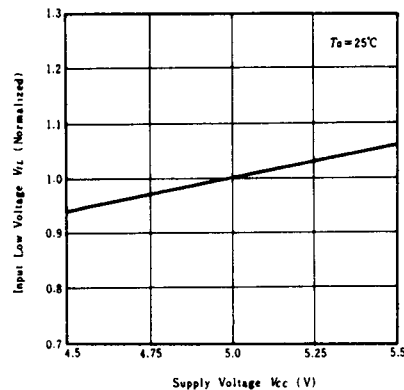

INPUT HIGH VOLTAGE VS. SUPPLY VOLTAGE

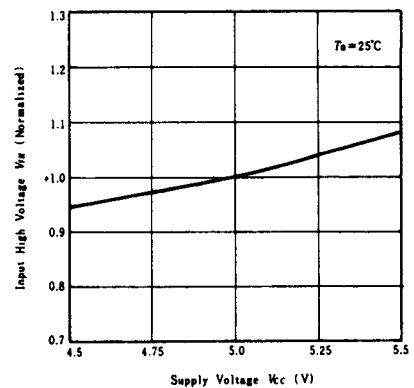

OUTPUT CURRENT VS. OUTPUT VOLTAGE

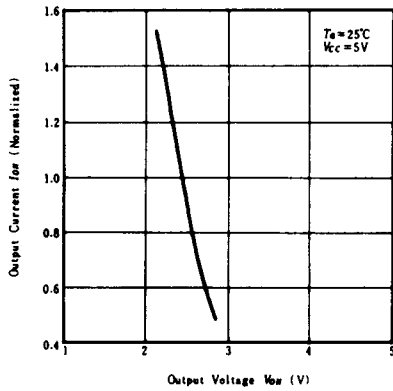

OUTPUT CURRENT VS. OUTPUT VOLTAGE

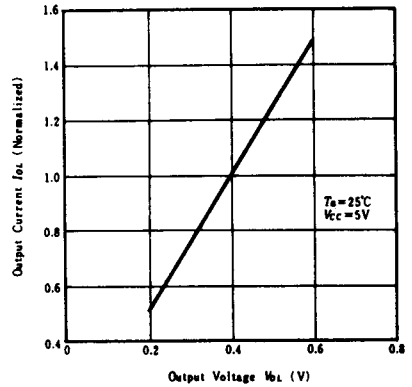

STANDBY CURRENT VS. AMBIENT TEMPERATURE

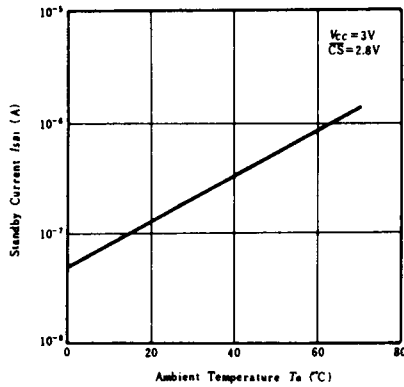

STANDBY CURRENT VS. SUPPLY VOLTAGE

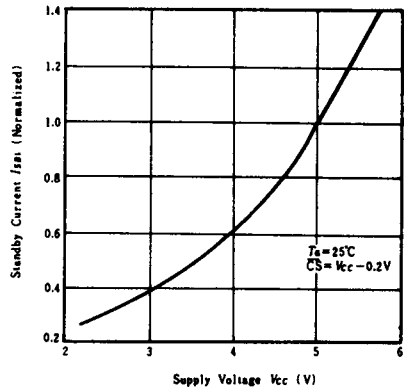

STANDBY CURRENT VS. INPUT VOLTAGE

